



Datasheet

3-in-1 Sentinel

Part No:
MA256.A.LBI.001

Description:

3-in-1 GNSS and 2*4G MIMO Low Profile, Adhesive Mount Combination Antenna with 2m cable and SMA(M) Connectors

Features:

3-in-1 low profile, adhesive mount combination antenna

1* GPS/GLONASS/BeiDou

2* 4G MIMO 600-3000MHz

Cables: 2m RG-174 GNSS, 2m TGC-1.5DS 4G MIMO

Connectors: SMA(M)ST

Dimensions: 128*76*12mm

RoHS & Reach Compliant

1. Introduction	3
2. Specifications	4
3. Active Antenna Characteristics	8
4. 4G Antenna Characteristics	13
5. Radiation Patterns	16
6. Mechanical Drawing	33
7. Packaging	34
<hr/>	
8. Application Note	35
<hr/>	
Changelog	38

Taoglas makes no warranties based on the accuracy or completeness of the contents of this document and reserves the right to make changes to specifications and product descriptions at any time without notice. Taoglas reserves all rights to this document and the information contained herein. Reproduction, use or disclosure to third parties without express permission is strictly prohibited.



1. Introduction



The Taoglas Sentinel, MA256 is a 3-in-1 adhesive mount combination antenna for use cases requiring worldwide 4G LTE MIMO coverage and GPS/GLONASS/BeiDou/Galileo for positioning. The MA256 has been designed to be mounted directly onto glass or plastic and can be mounted internally in vehicles, via high quality, first tier automotive approved 3M adhesive. The MA256 offers a convenient and economical alternative in-cabin mounting solution to larger permanent / on-roof mount solutions. The MA256 covers fallback to 3G/2G bands where 4G coverage is not available and can also be used to covers Cat M1/LTE-M & NB-IoT bands.

Typical Applications include:

- Automotive Vehicle Tracking
- Telematics
- Video Streaming
- Robotics/Autonomous

4G/LTE wireless applications demand high-speed data uplink and downlink. High efficiency and high gain MIMO antennas are necessary to achieve the required signal to noise ratio and throughput required to solve these challenges. Taoglas also takes care to have high isolation between the two MIMO antennas to prevent self-interference.

The IP67 waterproof PC / ABS enclosure measures just 128*76*12mm including the 3M foam adhesive. The antenna can be mounted internally or externally on a vehicle. Both 4G LTE MIMO 1 and MIMO 2 coaxial cables are 2m TGC-1.5DS with SMA(M) connectors and the GPS/GLONASS/BeiDou/Galileo cable is 2m RG-174 an includes an SMA(M) connector. Customized cable and connector versions are also available. Contact your regional Taoglas customer support team for more information.

2. Specifications

GNSS Frequency Bands Covered							
GPS/QZSS	L1 1575.42MHz	L2 1227.6MHz	L5 1176.45MHz	L6 1278.75MHz			
	■	□	□	□			
GLONASS	L5R 1176.45MHz	L3PT 1201.5MHz	L2PT 1246MHz	L1CR 1575.42MHz	L1PT 1602MHz		
	□	□	□	□	□		
Galileo	E5a 1176.45MHz	E5b 1201.5MHz	E4 1215MHz	E3 1256MHz	E6 1278.75MHz	E2 1561MHz	L1 1575.42MHz
	□	□	□	□	□	■	■
BeiDou	B1 1561MHz	B2 1207.14MHz	B3 1268.52MHz				
	■	□	□				
Compass	E5B(B2)/ E6(B3) 1268.56MHz	E2(B1) 1561MHz					
	□	■					
SBAS	Omnistar 1542.5MHz	WAAS/EGN OS 1575.42MHz					
	□	■					

GNSS Electrical			
Frequency (MHz)	1561	1575.42	1602
VSWR (max.)	3.0:1	2.0:1	2.0:1
Passive Antenna Efficiency (%)	42.6	56.89	61.9
Passive Antenna Gain at Zenith (dBic)	1.08	2.11	2.08
Axial Ratio (dB)	13	9	3
Polarization	RHCP		
Impedance	50Ω		
Cable	RG-174		
Connector	SMA(M)		

LNA and Filter Electrical Properties			
Frequency (MHz)	1561	1575.42	1602
VSWR (max.)	2.0:1	2.0:1	2.0:1
Gain@1.8V (Typ.)	28.8	28.8	28.0
Gain@3.0V (Typ.)	29.1	29.0	28.3
Gain@5.5V (Typ.)	29.6	29.3	28.7
Noise@1.8V (Typ.)	2.7	2.2	2.7
Noise@3.0V (Typ.)	2.7	2.2	2.6
Noise@5.5V (Typ.)	2.8	2.2	2.7
Power consumption@1.8V (Typ.)	8.6		
Power consumption@3.0V (Typ.)	8.9		
Power consumption@5.5V (Typ.)	10.5		
Total Specification (Through Antenna, SAW Filter and LNA)			
Frequency (MHz)	1561	1575.42	1602
Gain@3V (dBi)	28	28	28
Noise@3V (dB)	3	3	3
Output Impedance	50 Ω		

4G LTE Electrical

Band	Frequency (MHz)		Efficiency (%)	Average Gain (dB)	Peak Gain (dBi)	Impedance	Max Input Power	Polarization	Radiation Pattern
5G NR/4G Band 71	617~698	MIMO 1	26	-5.9	-0.1	50 Ω	2W	Linear	Omni-Directional
		MIMO 2	17.8	-7.5	-3.9				
4G/3G Band 12,13,14,17,28,29	698~806	MIMO 1	30.9	-5.1	-0.1				
		MIMO 2	29.3	-5.3	-0.6				
4G/3G/NB-IoT/Cat M Band 5,8,18,19,20,26,27	824~960	MIMO 1	32.2	-4.9	-0.4				
		MIMO 2	20.3	-6.9	-3.1				
5G NR/4G Band 21,32,74,75,76	1427~1518	MIMO 1	17.6	-7.5	-3.1				
		MIMO 2	17.5	-7.6	-2.3				
4G/3G Band 1,2,3,4,9,23,25,35,39,66	1710~2200	MIMO 1	37.3	-4.3	-0.6				
		MIMO 2	28	-5.4	-0.2				
4G/3G Band 7,38,41	2490~2690	MIMO 1	23.7	-6.3	-1				
		MIMO 2	24.3	-6.1	-1.8				

Mechanical

Height	12mm
Planar Dimension	128mm * 76mm
Casing	PC+ABS
Cable	2m TGC-1.5DS for LTE MIMO – Fully Customizable 2m RG174 for GNSS – Fully Customizable
Connector	2* LTE: SMA-Plug – Fully Customizable GNSS: SMA-Plug – Fully Customizable
Weight	130 g (Not Including Packaging)
Environmental	
Protection	IP67
Temperature Range	-40°C to 85°C
Humidity	Non-condensing 65°C 95% RH
Cable Pull Force	RG174 - 4 Kg

5G/4G Bands			
Band Number	5G NR / FR1 / LTE / LTE-Advanced / WCDMA / HSPA / HSPA+ / TD-SCDMA / Cat M / NB-IoT		
	Uplink	Downlink	Covered
1	UL: 1920 to 1980	DL: 2110 to 2170	✓
2	UL: 1850 to 1910	DL: 1930 to 1990	✓
3	UL: 1710 to 1785	DL: 1805 to 1880	✓
4	UL: 1710 to 1755	DL: 2110 to 2155	✓
5	UL: 824 to 849	DL: 869 to 894	✓
7	UL: 2500 to 2570	DL: 2620 to 2690	✓
8	UL: 880 to 915	DL: 925 to 960	✓
9	UL: 1749.9 to 1784.9	DL: 1844.9 to 1879.9	✓
11	UL: 1427.9 to 1447.9	DL: 1475.9 to 1495.9	✗
12	UL: 699 to 716	DL: 729 to 746	✓
13	UL: 777 to 787	DL: 746 to 756	✓
14	UL: 788 to 798	DL: 758 to 768	✓
17	UL: 704 to 716	DL: 734 to 746	✓
18	UL: 815 to 830	DL: 860 to 875	✓
19	UL: 830 to 845	DL: 875 to 890	✓
20	UL: 832 to 862	DL: 791 to 821	✓
21	UL: 1447.9 to 1462.9	DL: 1495.9 to 1510.9	✗
22	UL: 3410 to 3490	DL: 3510 to 3590	✗
23	UL: 2000 to 2020	DL: 2180 to 2200	✓
24	UL: 1625.5 to 1660.5	DL: 1525 to 1559	✓
25	UL: 1850 to 1915	DL: 1930 to 1995	✓
26	UL: 814 to 849	DL: 859 to 894	✓
27	UL: 807 to 824	DL: 852 to 869	✓
28	UL: 703 to 748	DL: 758 to 803	✓
29	UL: -	DL: 717 to 728	✓
30	UL: 2305 to 2315	DL: 2350 to 2360	✓
31	UL: 452.5 to 457.5	DL: 462.5 to 467.5	✗
32	UL: -	DL: 1452 - 1496	✓
35		1850 to 1910	✓
38		2570 to 2620	✓
39		1880 to 1920	✓
40		2300 to 2400	✓
41		2496 to 2690	✓
42		3400 to 3600	✗
43		3600 to 3800	✗
48		3550 to 3700	✗
66	UL: 1710-1780	DL: 2110-2200	✓
71		617 to 698	✓
74/75/76		1427 to 1518	✗
77		3300 to 4200	✗
78		3300 to 3800	✗
79		4400 to 5000	✗

3. Active Antenna Characteristics

3.1 Block Diagram

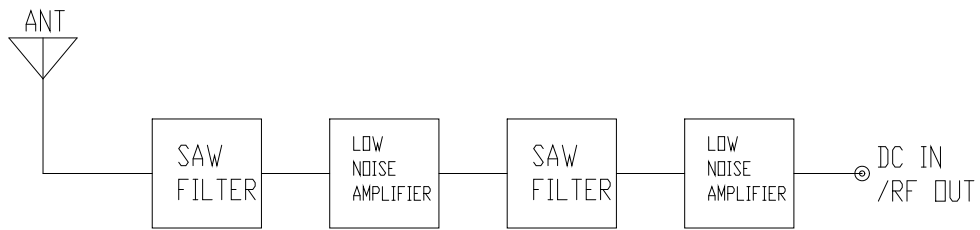

3.2 Passive Antenna Return Loss

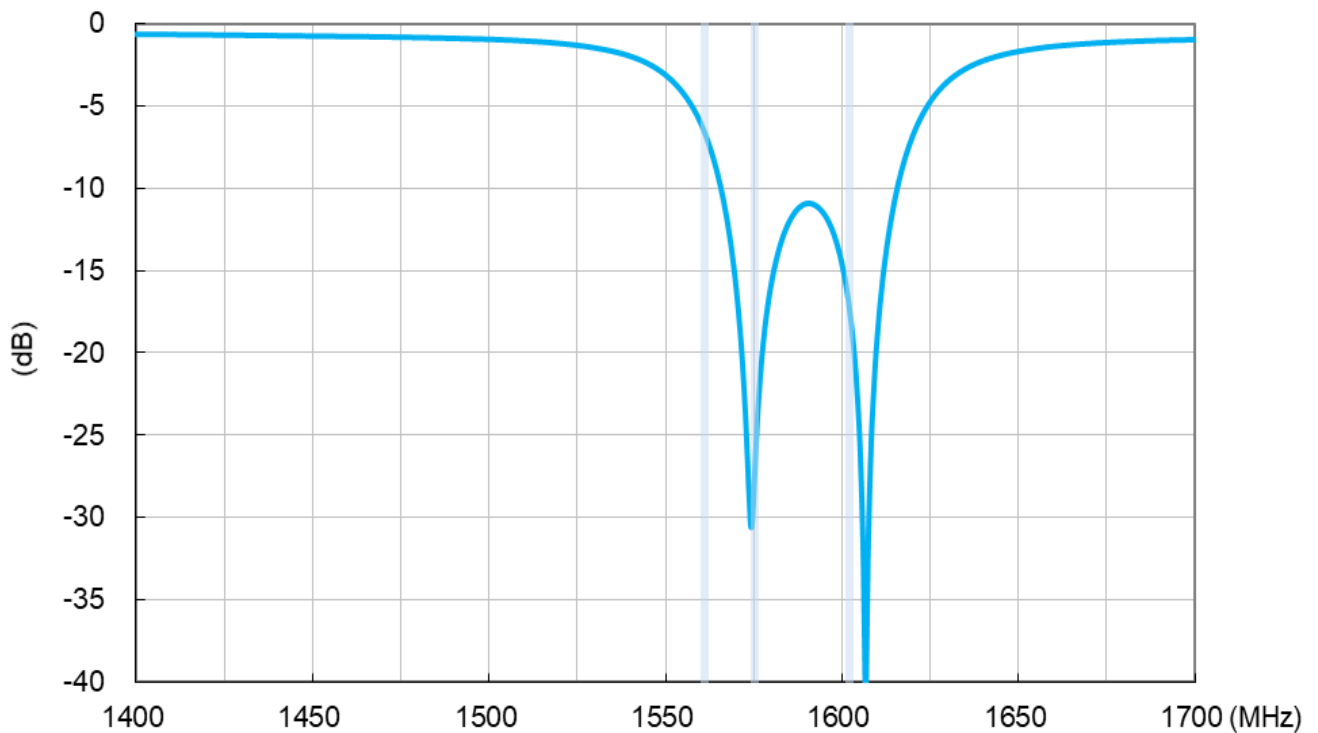

3.3 Passive Antenna Efficiency

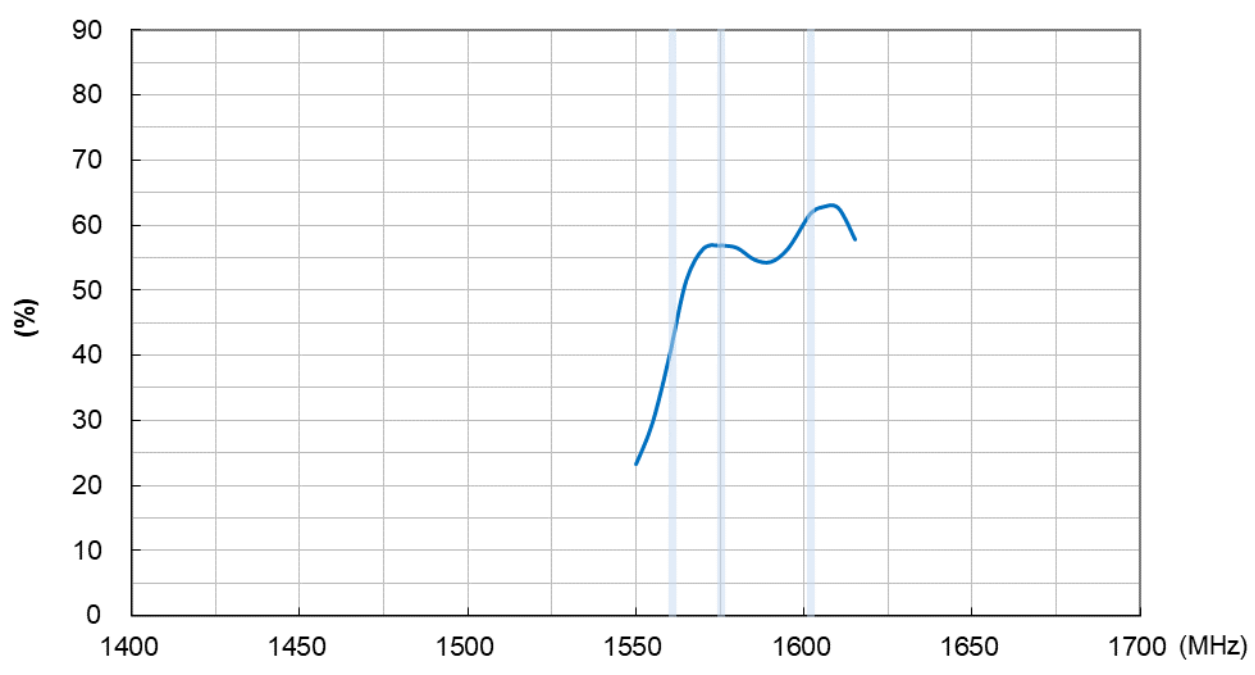

3.4 Passive Antenna Average Gain

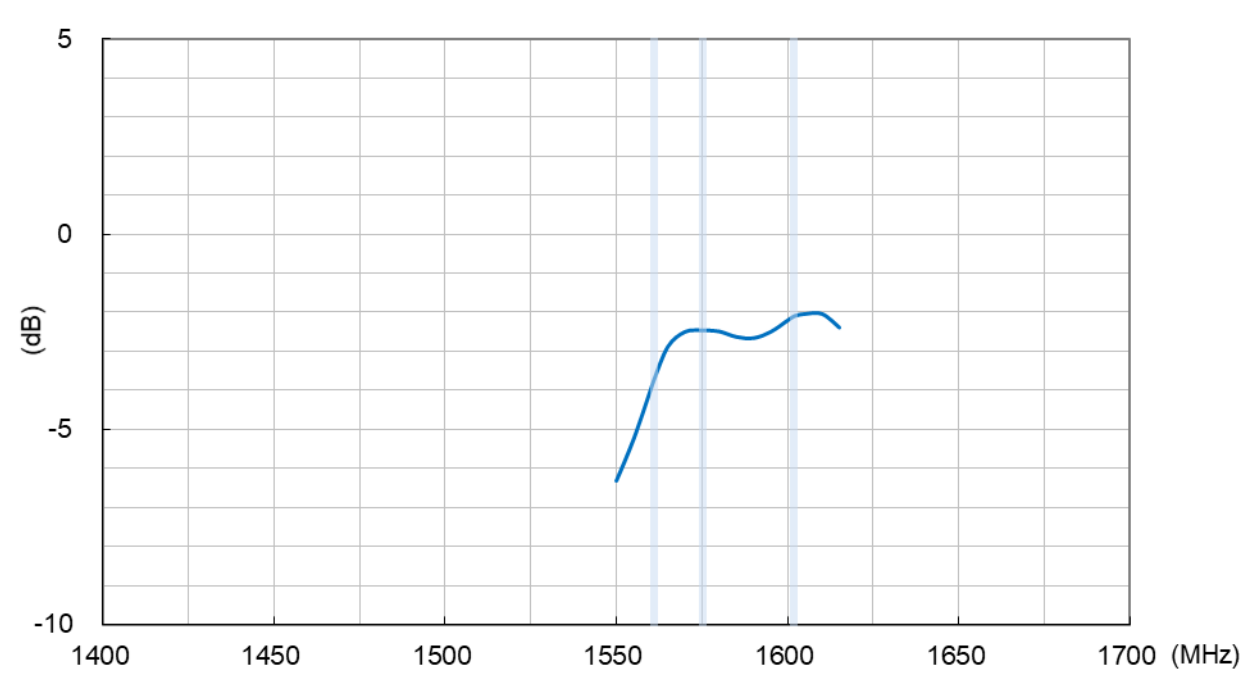

3.5 Passive Antenna Peak Gain

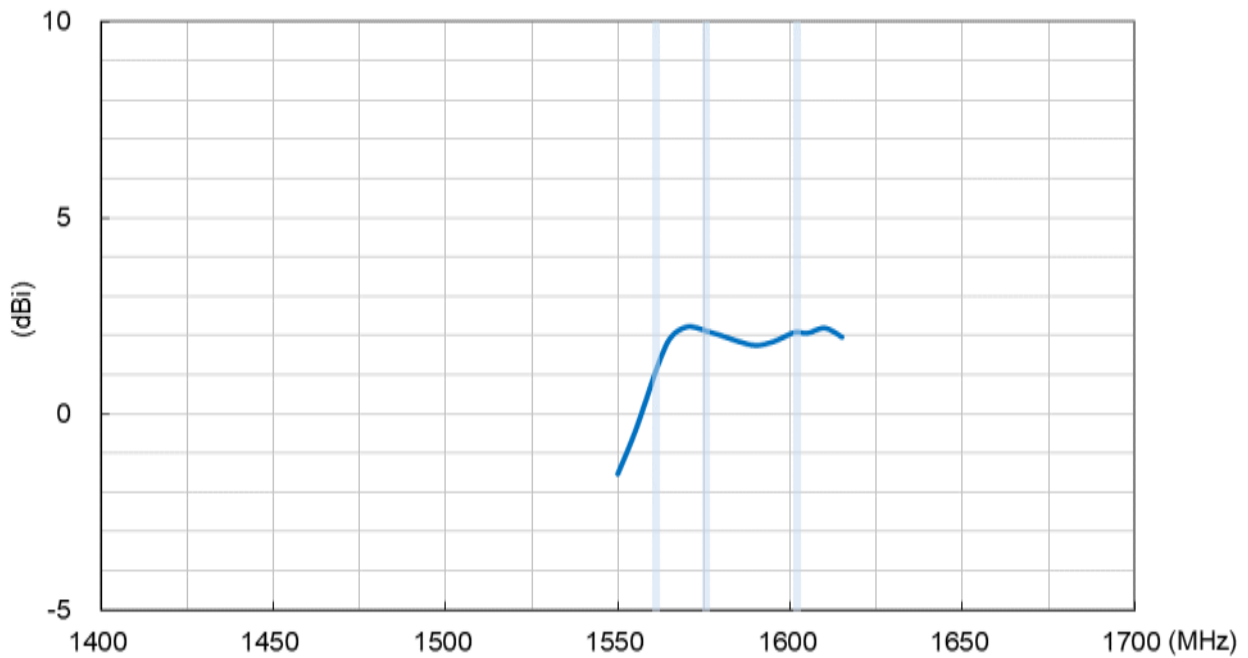

3.6 Passive Antenna Axial Ratio (Zenith is at 0°)

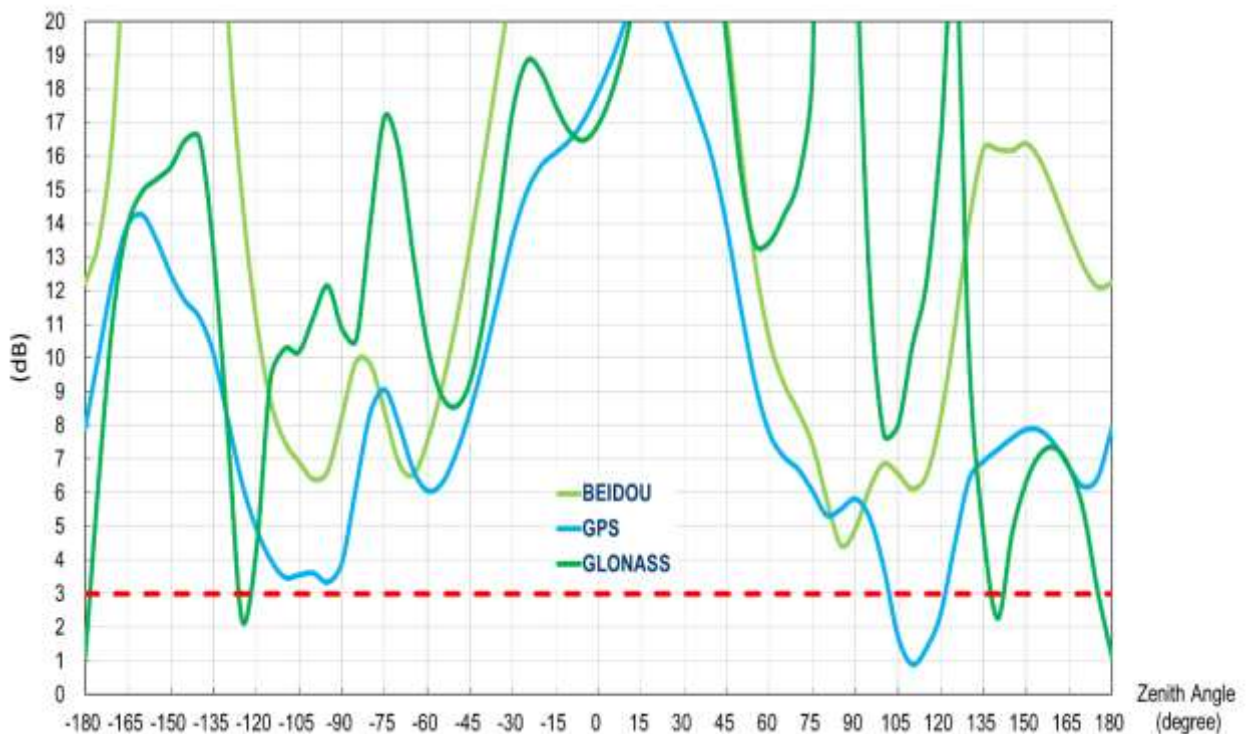

3.7 Active Measurements

LNA Gain @3.0V

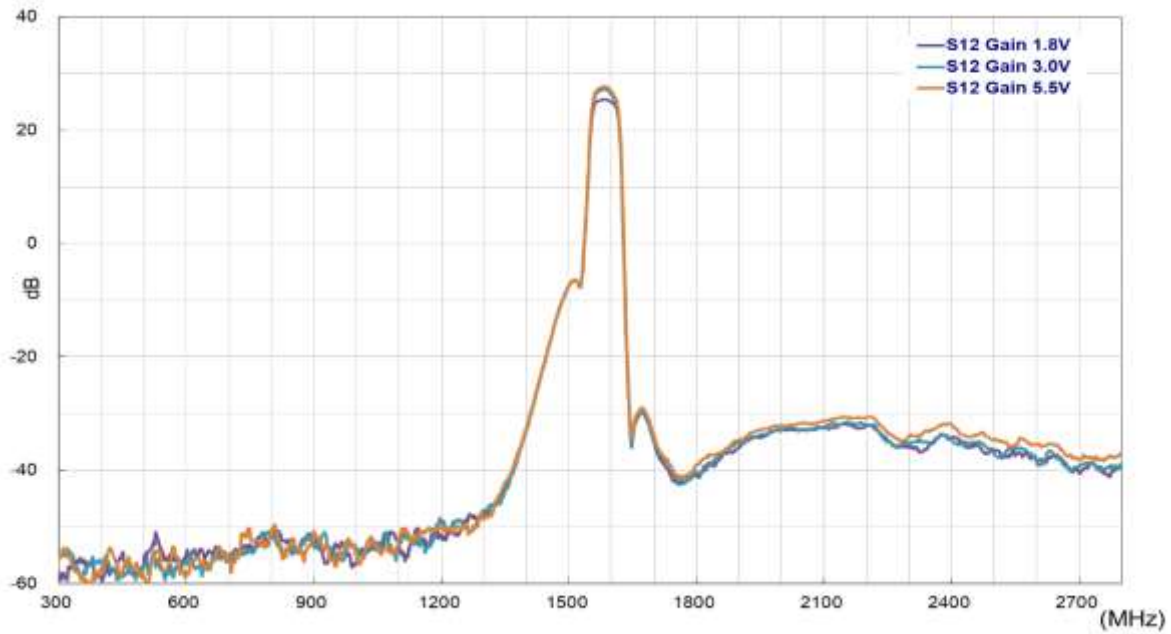

3.8 Passive Antenna Axial Ratio (Zenith is at 0°)

Noise Figure @ 3.0V

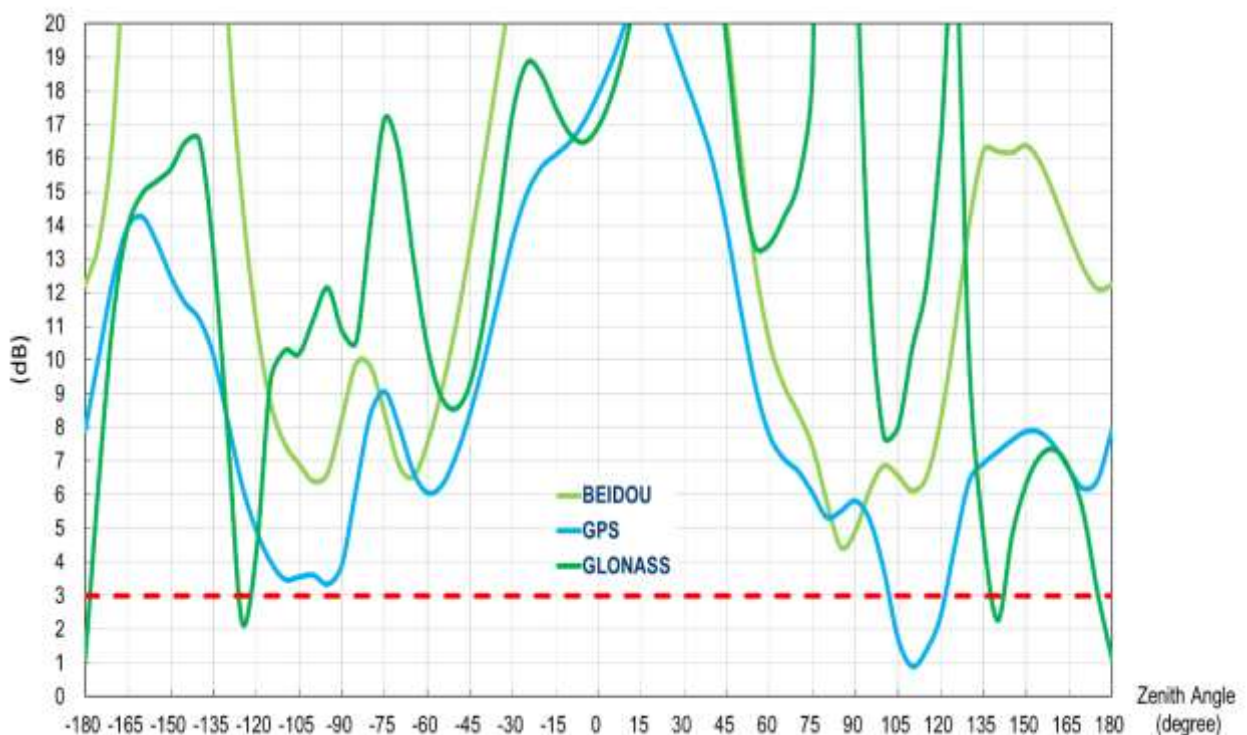

3.9 GNSS 3D and 2D Radiation Patterns

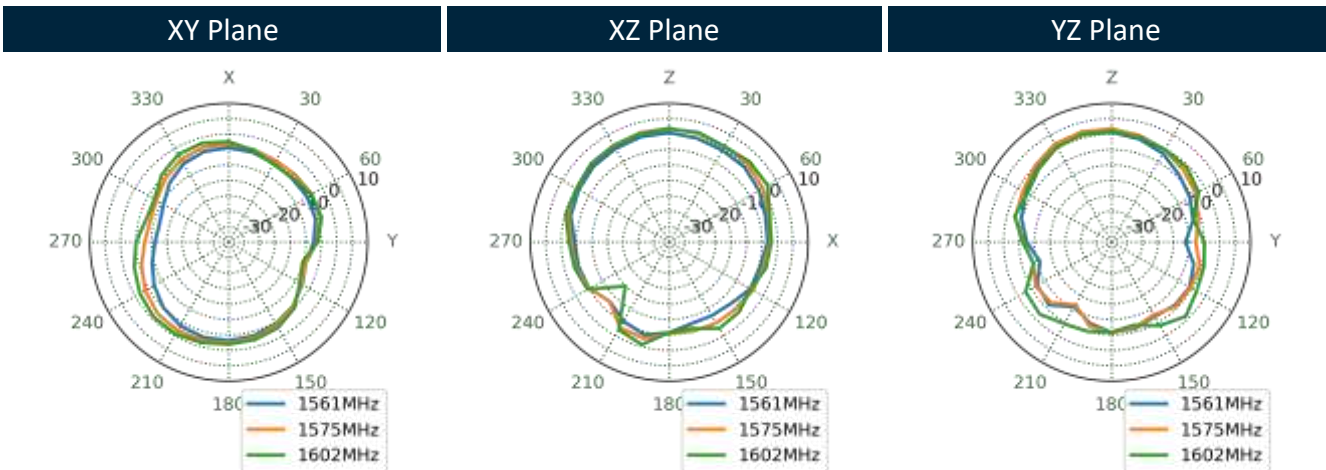
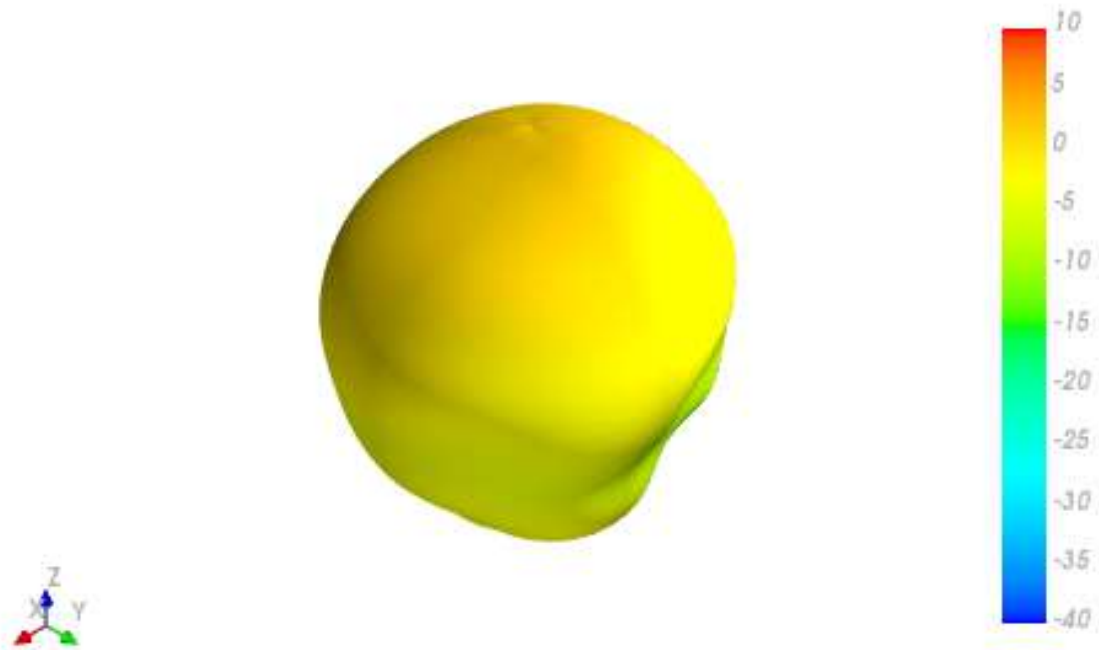

4. 4G Antenna Characteristics

4.1 Return Loss

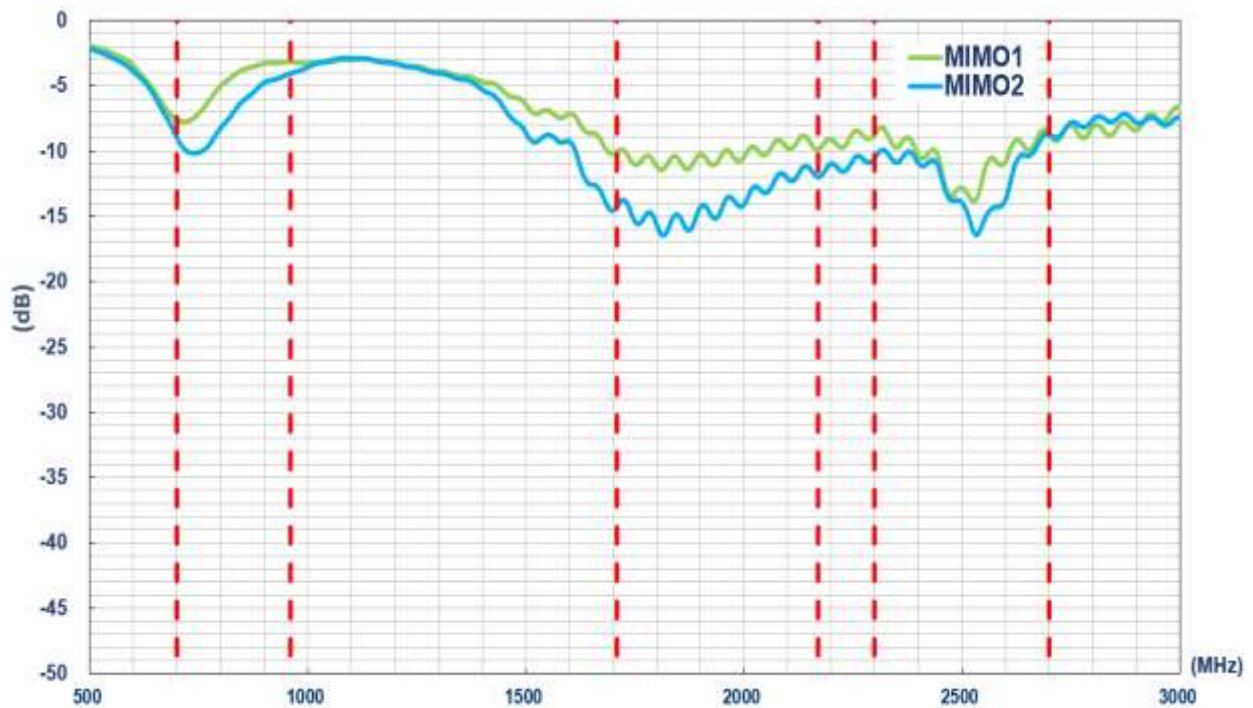

4.2 Isolation

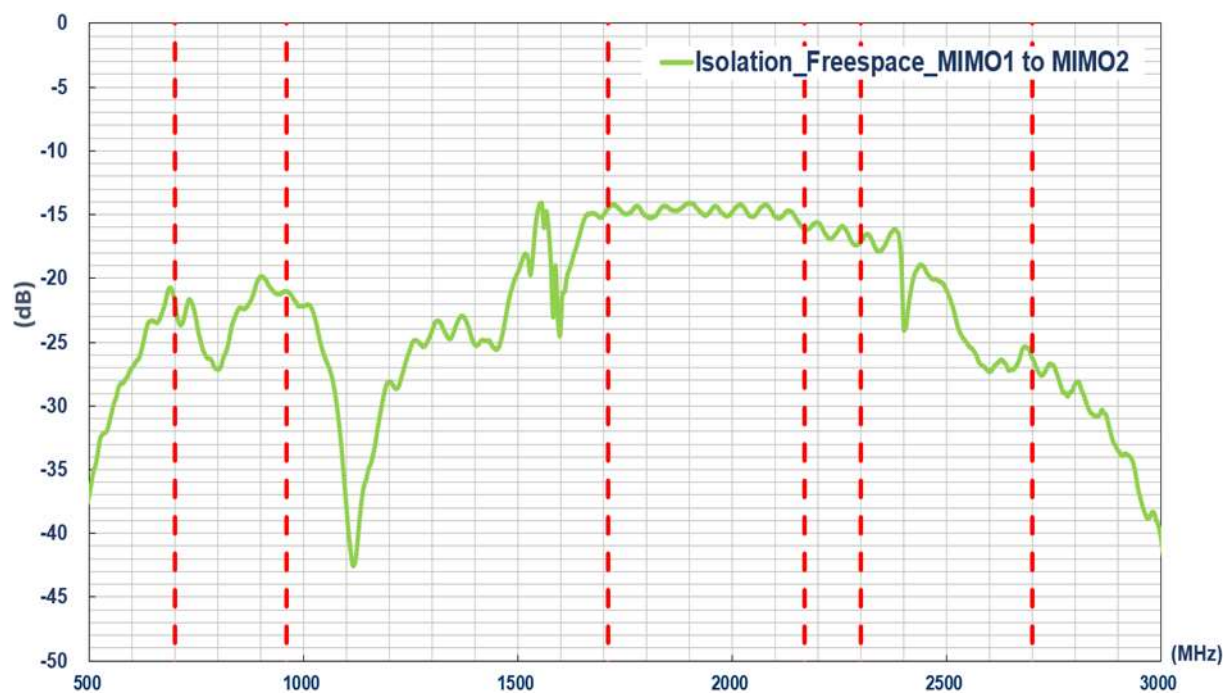

4.3 Efficiency

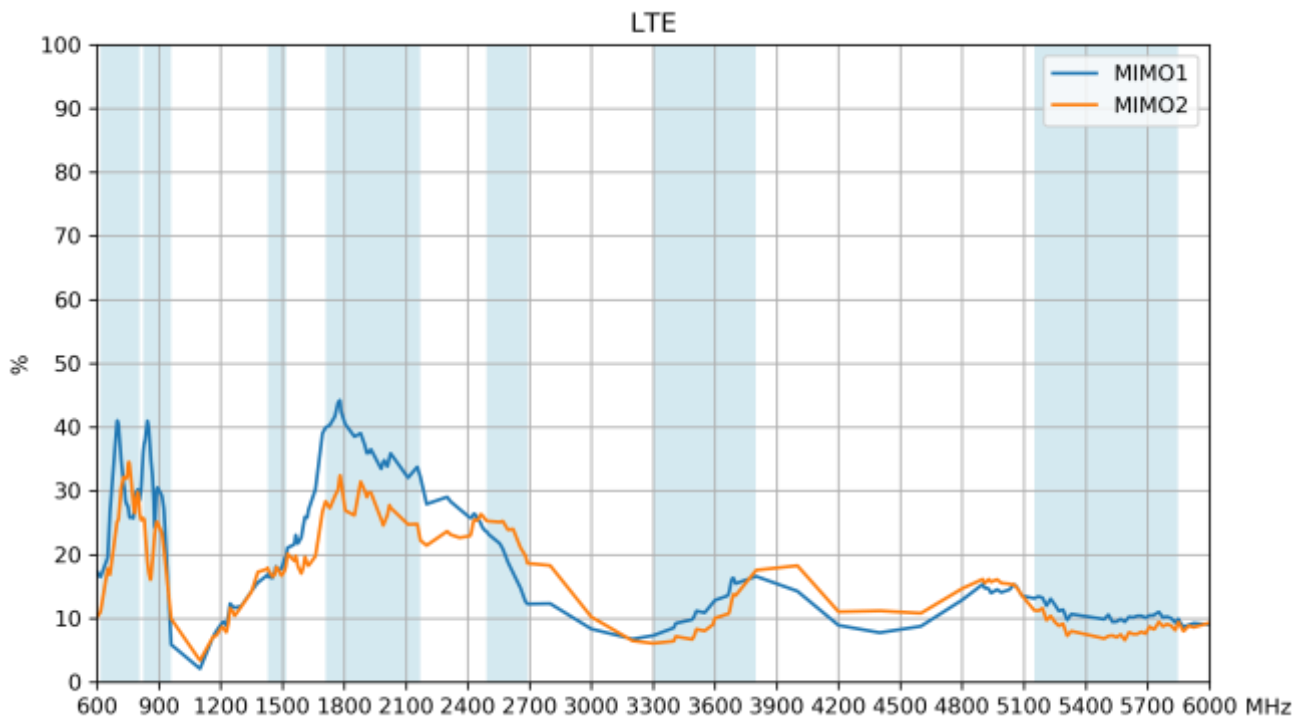

4.4 Average Gain

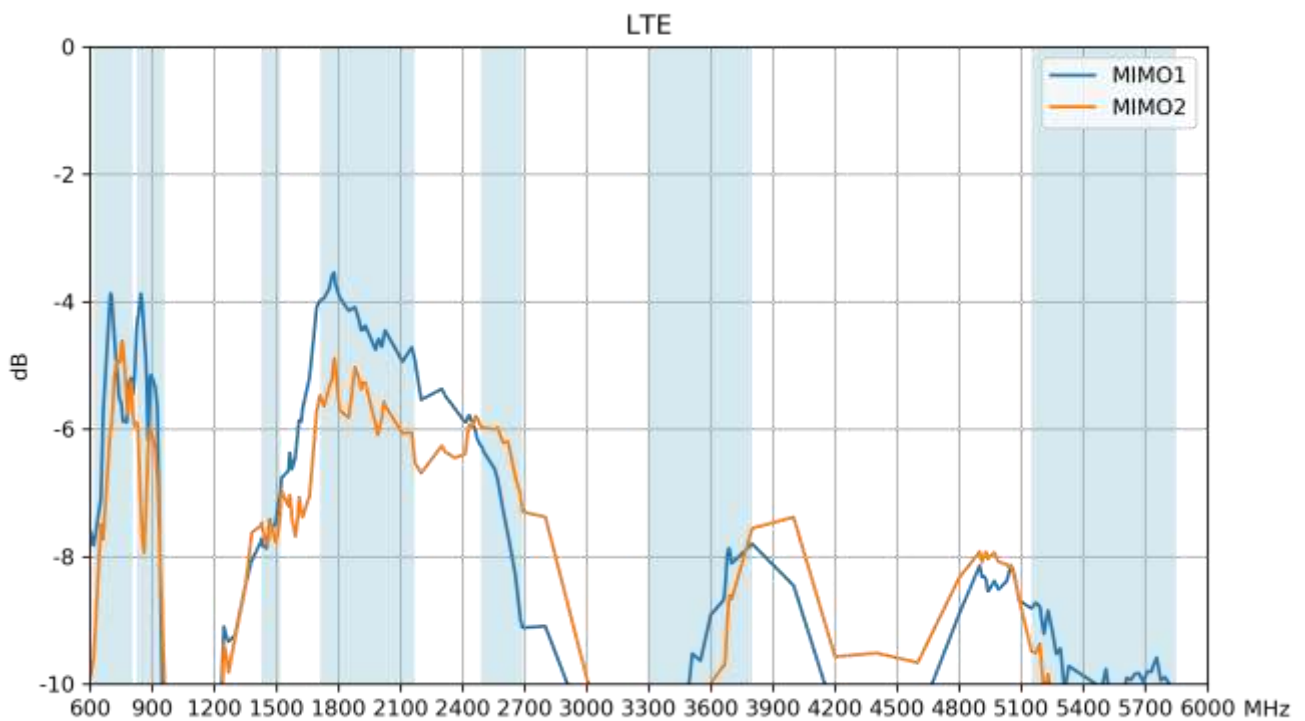

4.5 Peak Gain

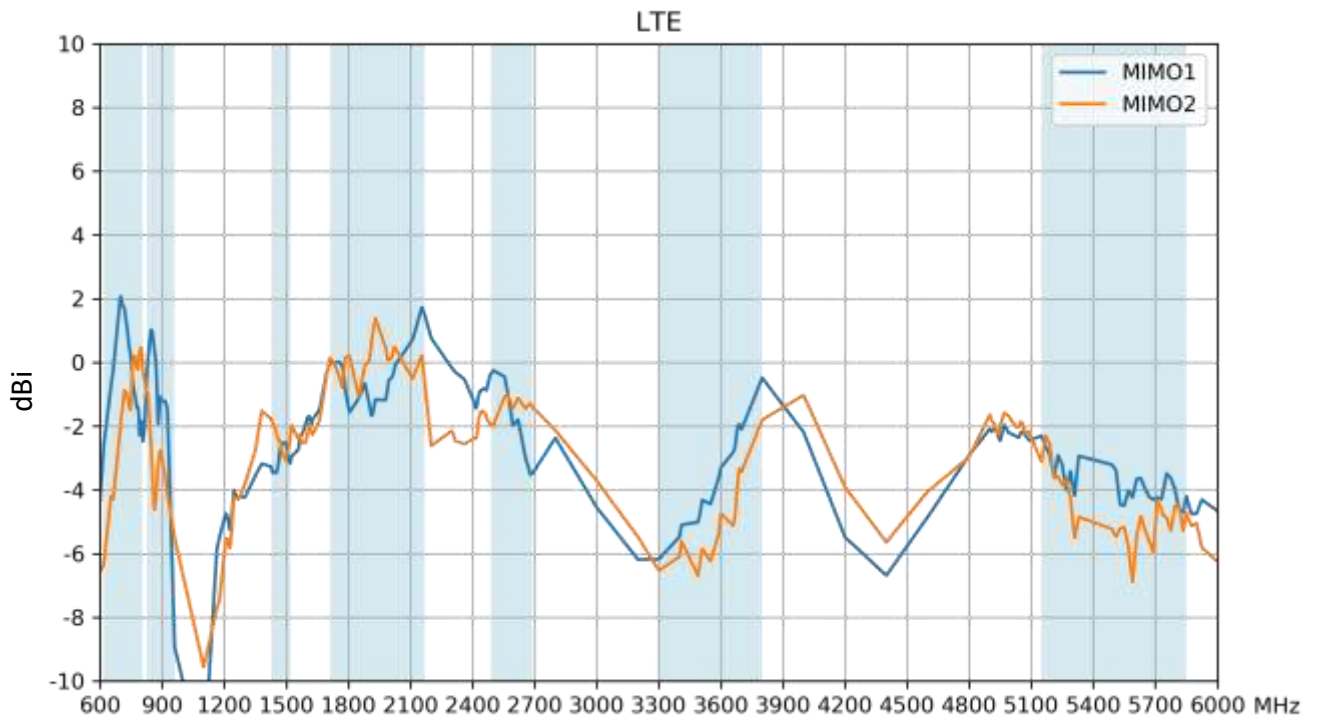

5. Radiation Patterns

4.1 Test Setup

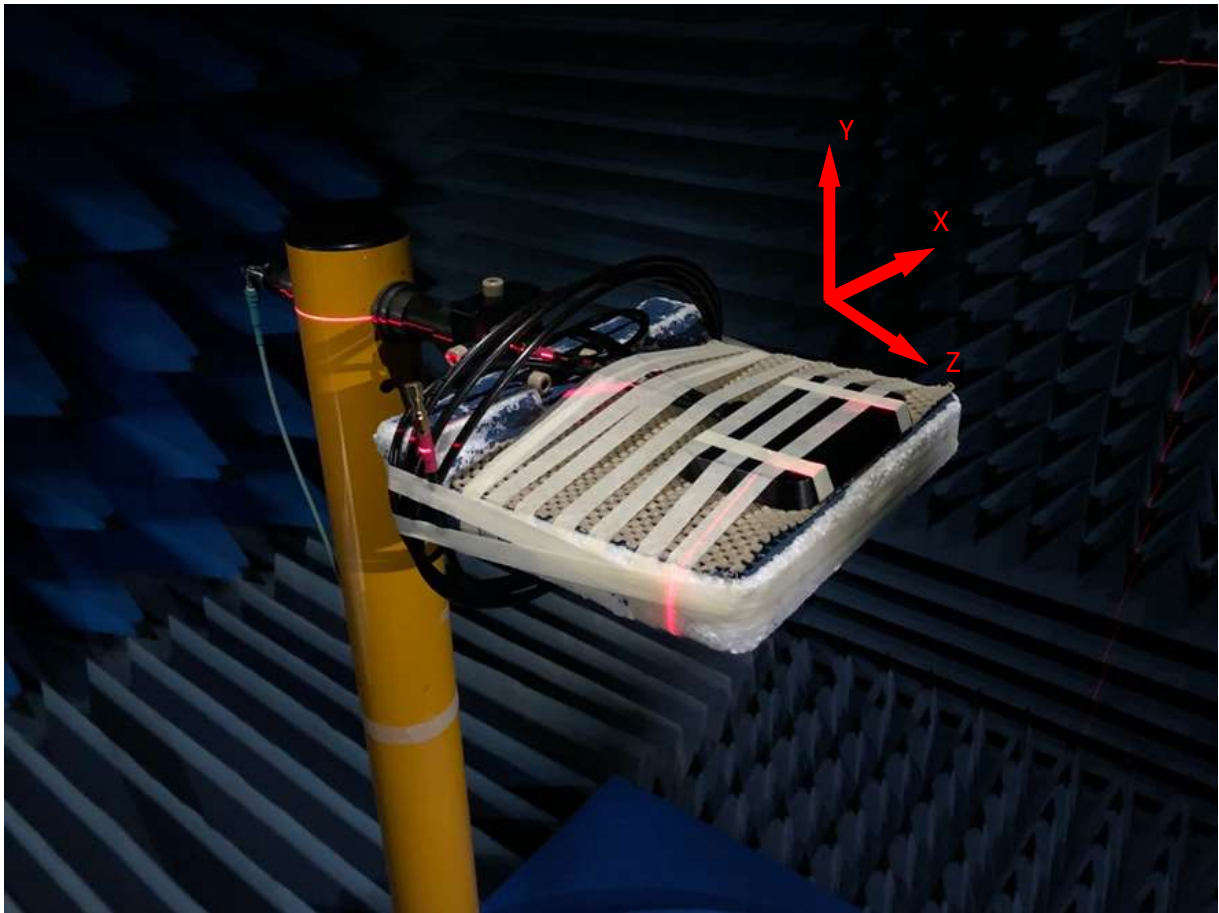

Free space

4.2 4G MIMO 1 - 3D and 2D Radiation Patterns

652MHz

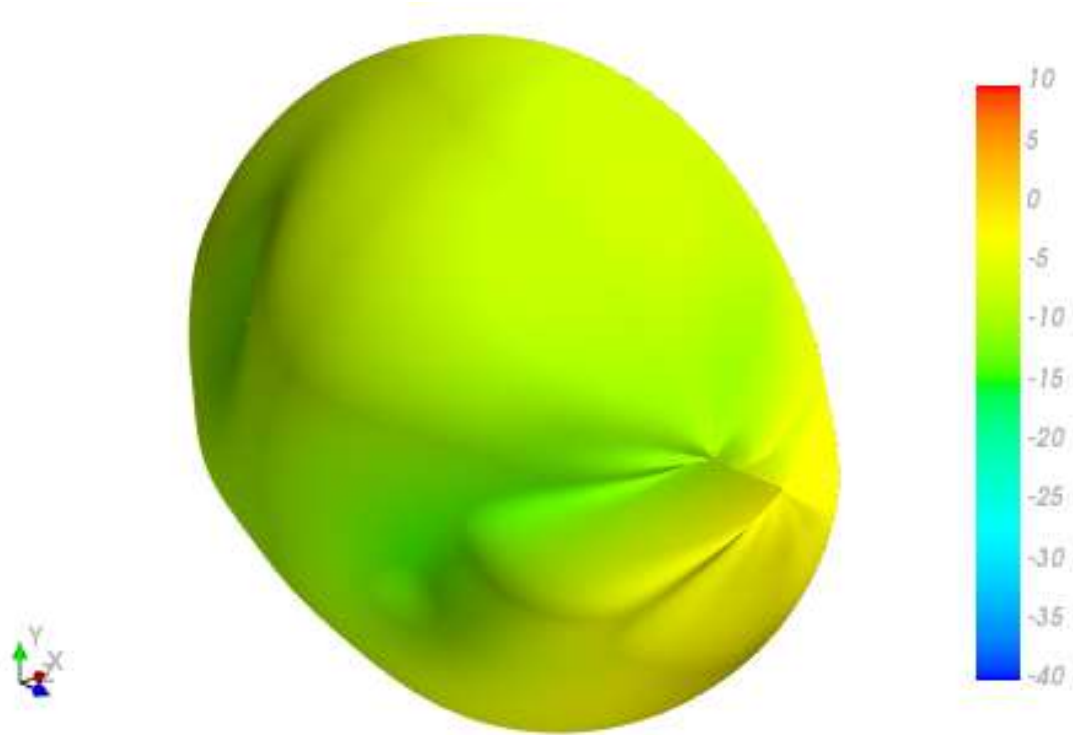

XY Plane

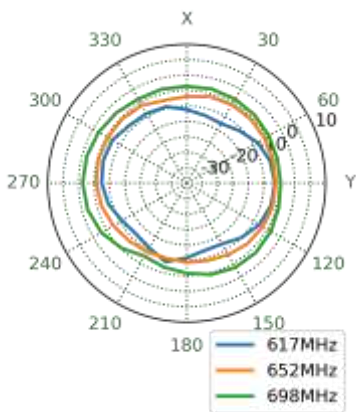

XZ Plane

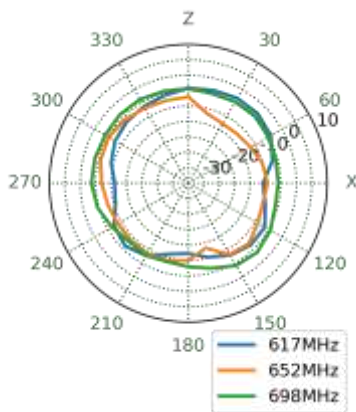

YZ Plane

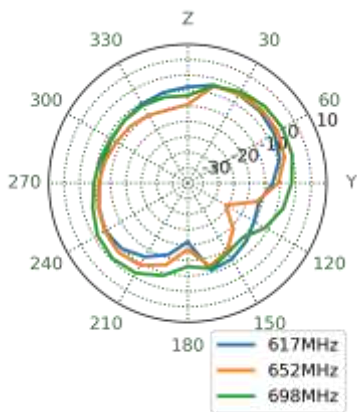

751MHz

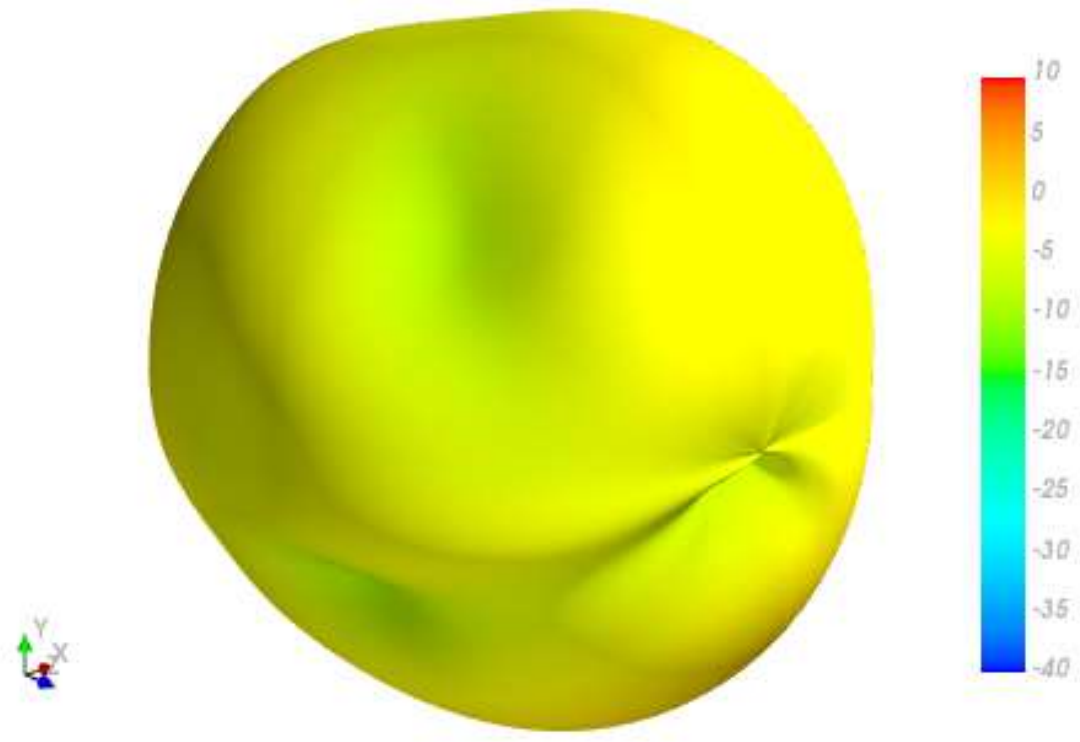

XY Plane

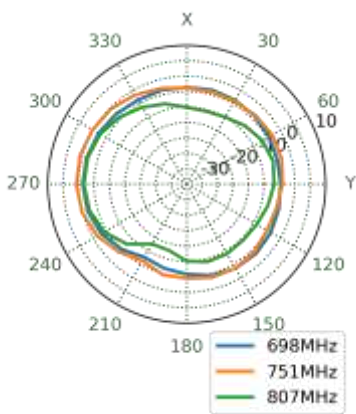

XZ Plane

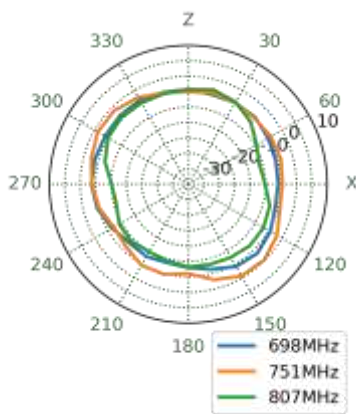

YZ Plane

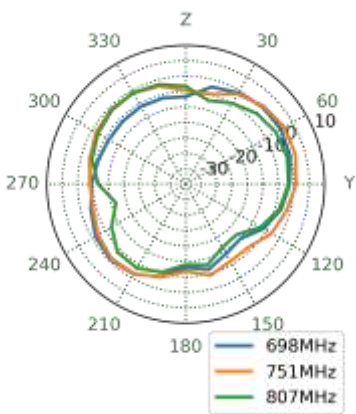

890MHz

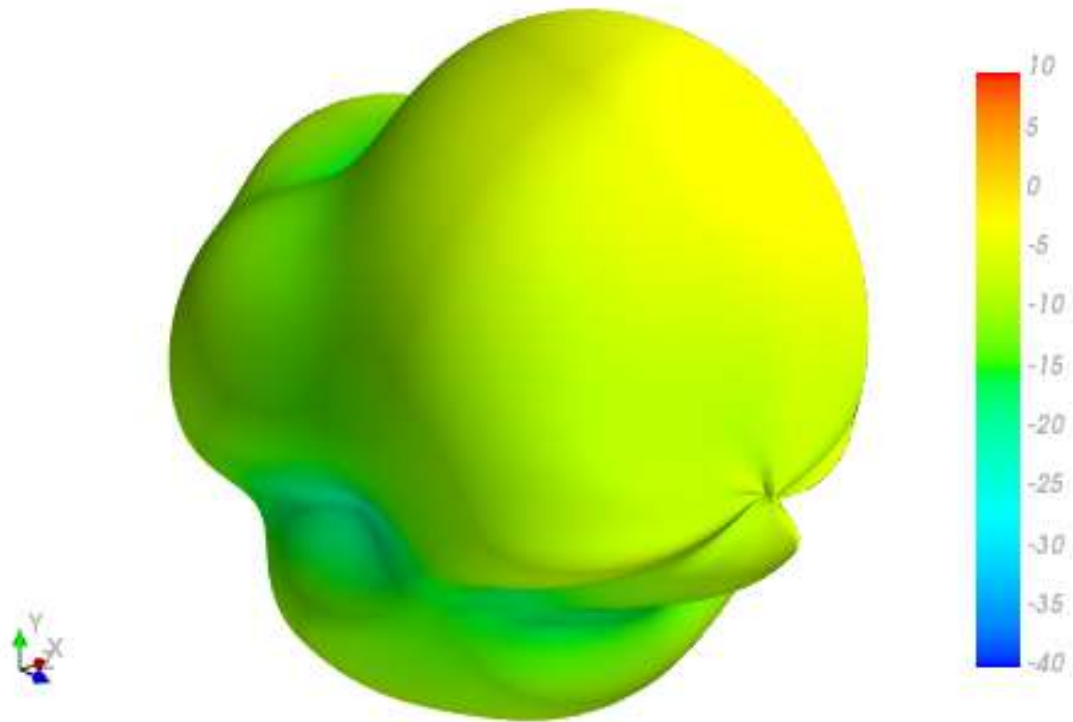

XY Plane

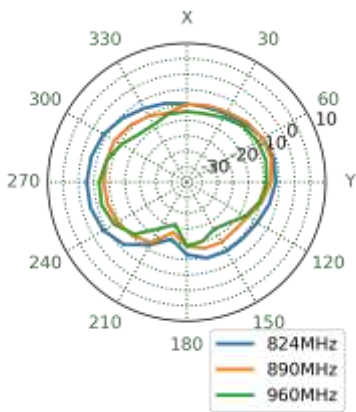

XZ Plane

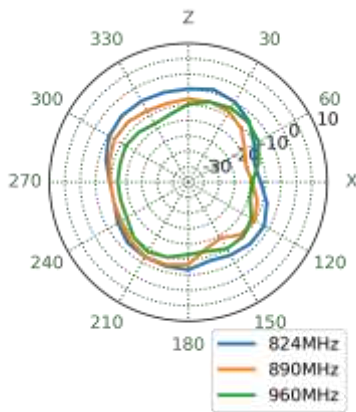

YZ Plane

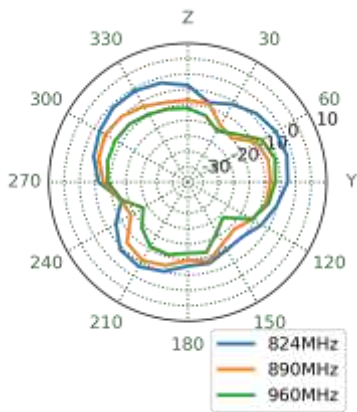

1470MHz

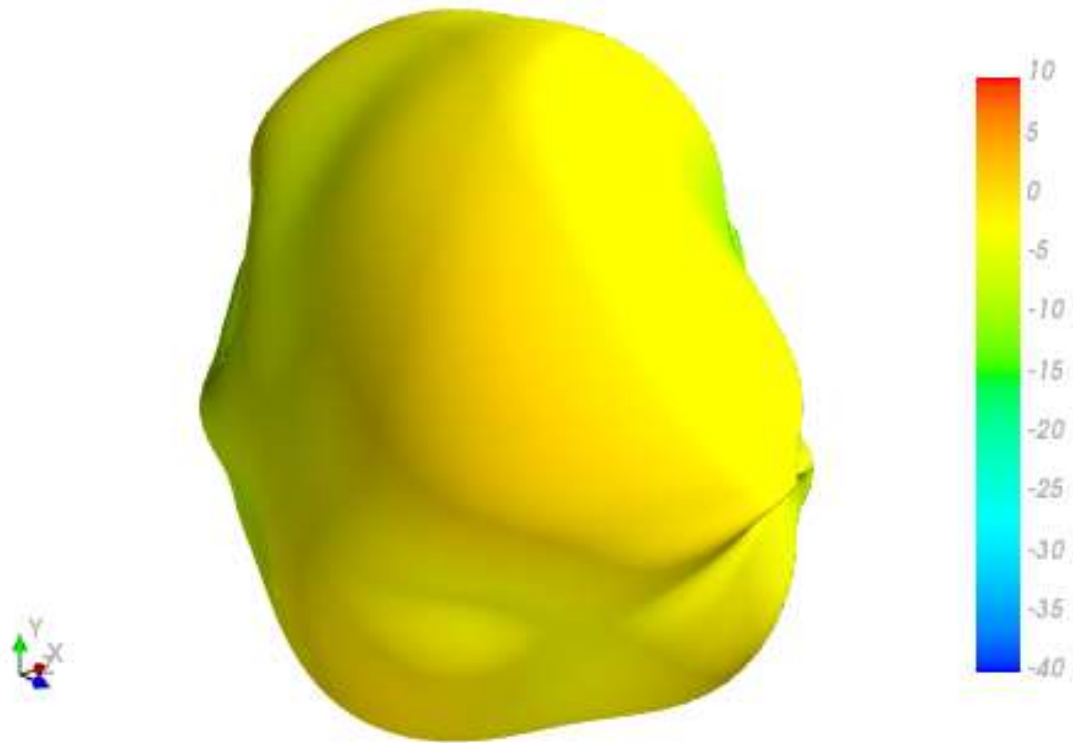

XY Plane

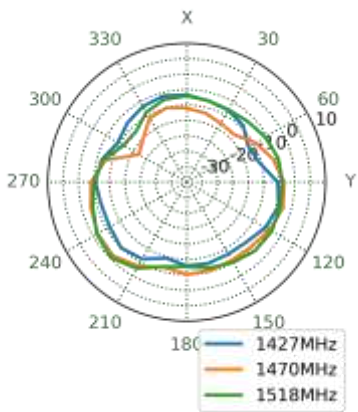

XZ Plane

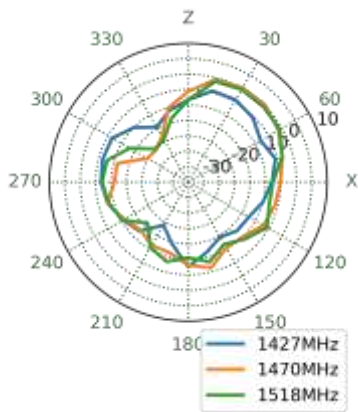

YZ Plane

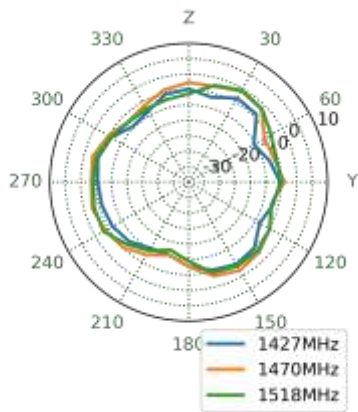

1805MHz

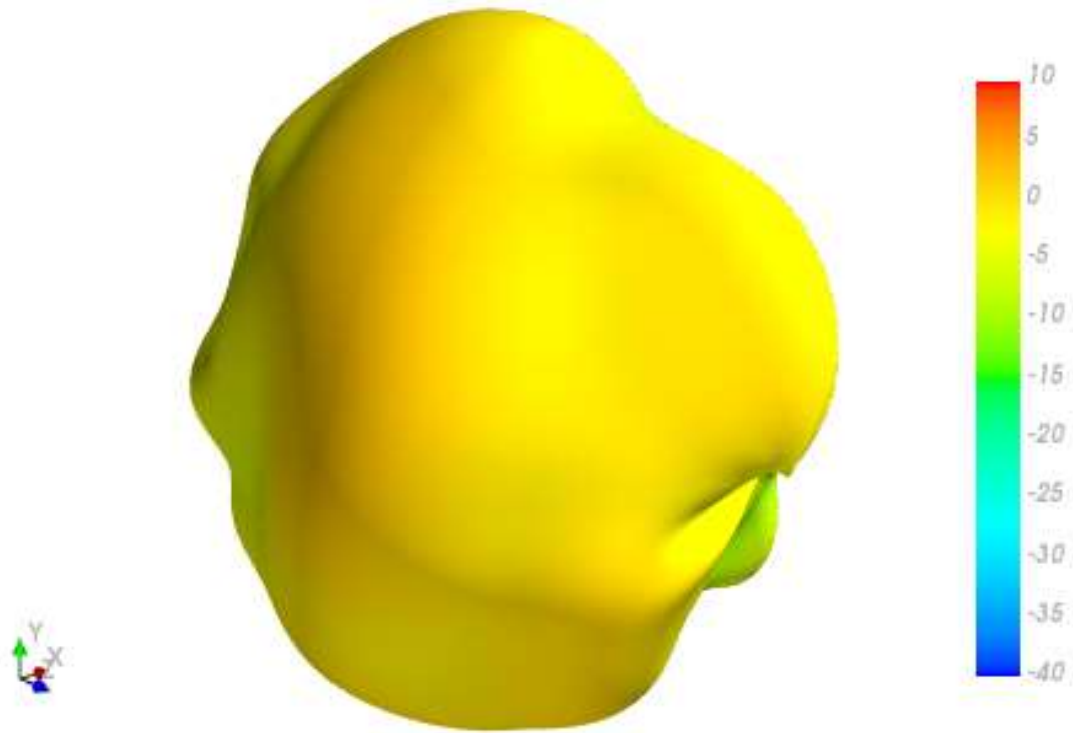

XY Plane

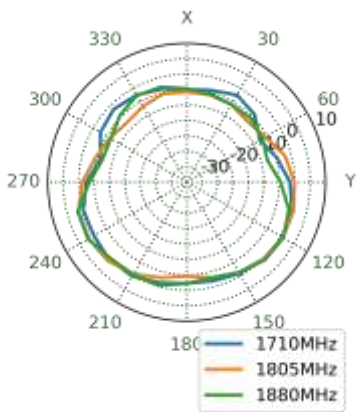

XZ Plane

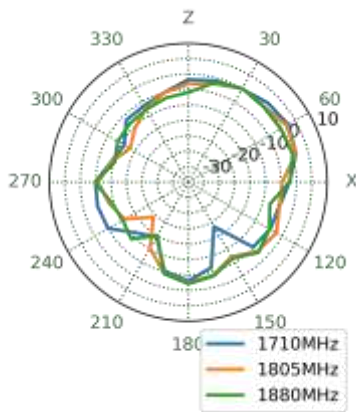

YZ Plane

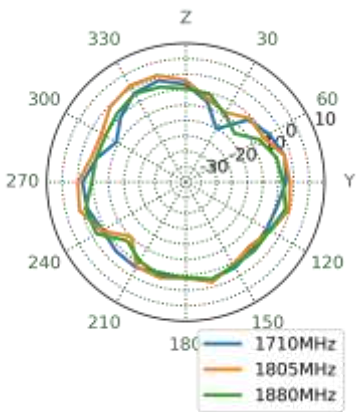

1920MHz

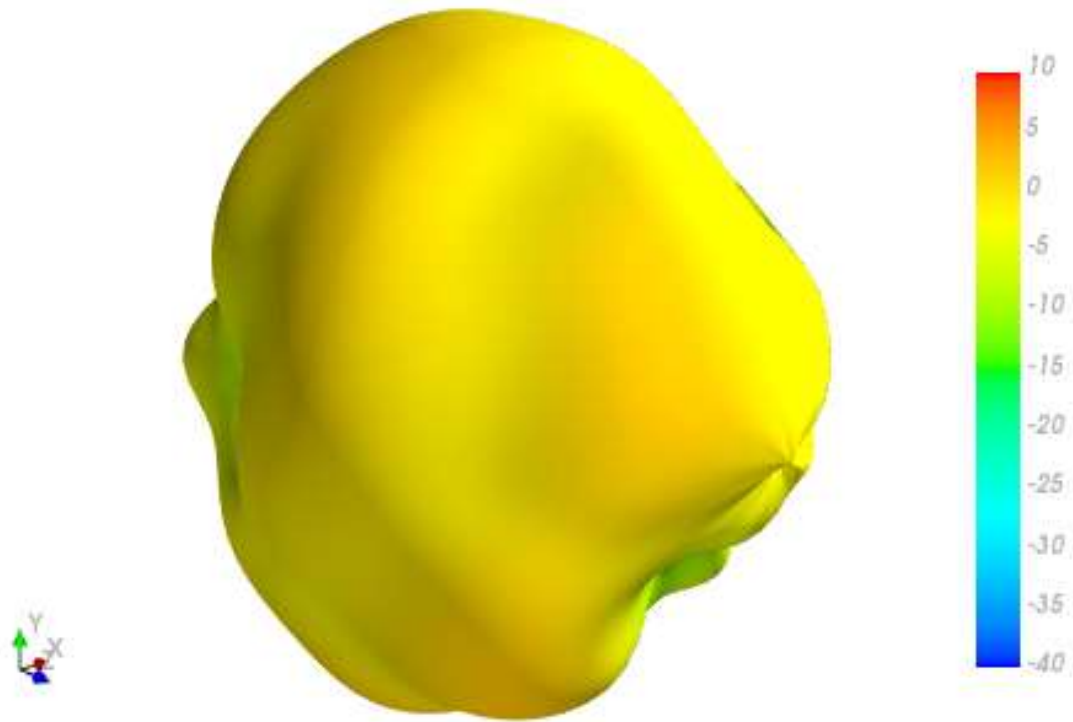

XY Plane

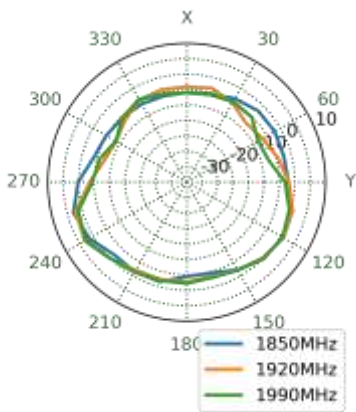

XZ Plane

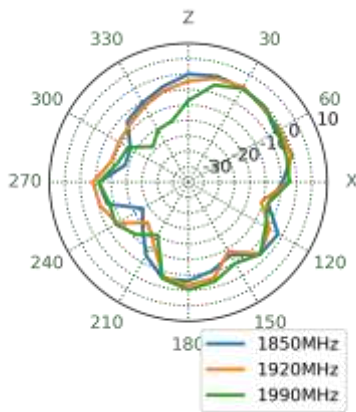

YZ Plane

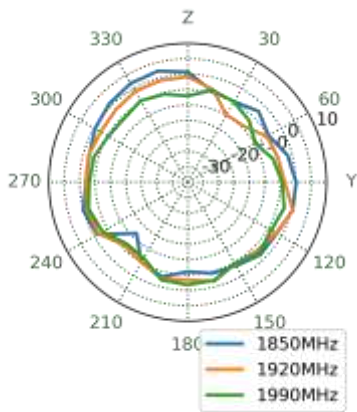

1990MHz

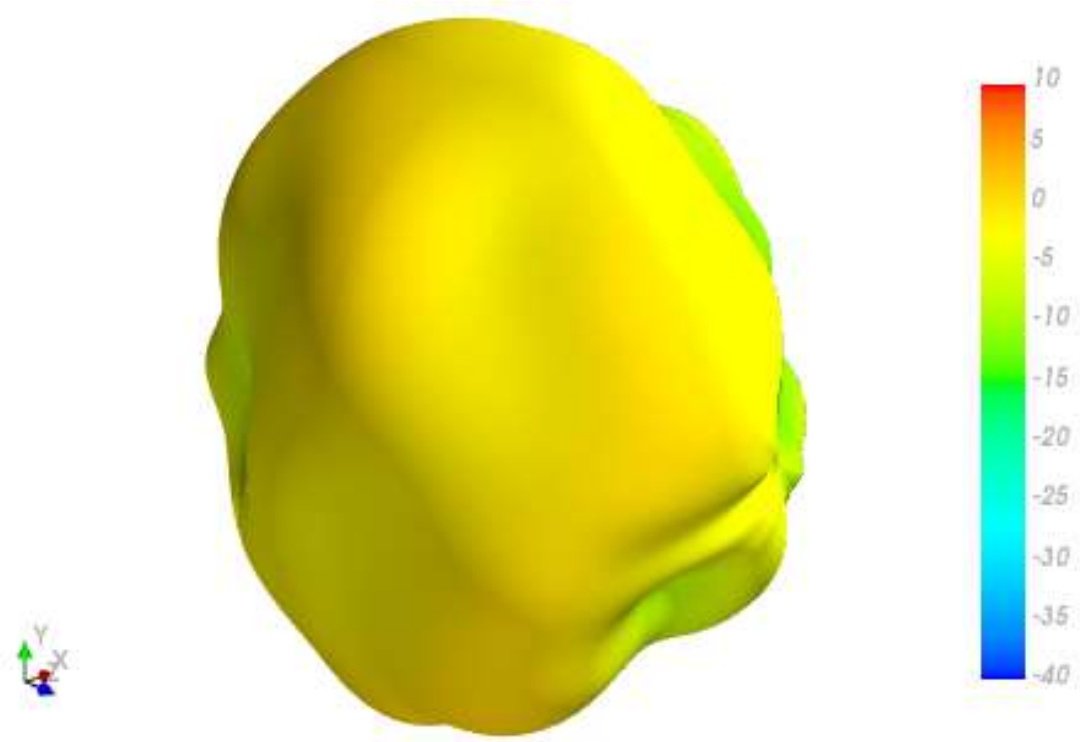

XY Plane

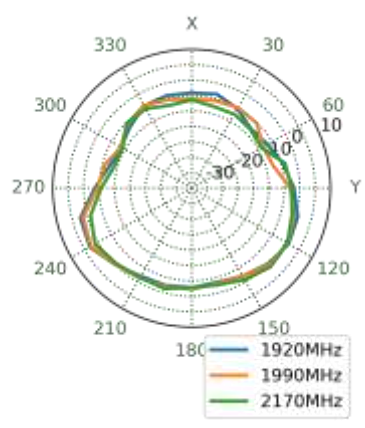

XZ Plane

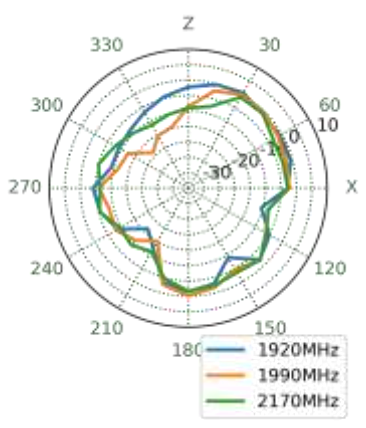

YZ Plane

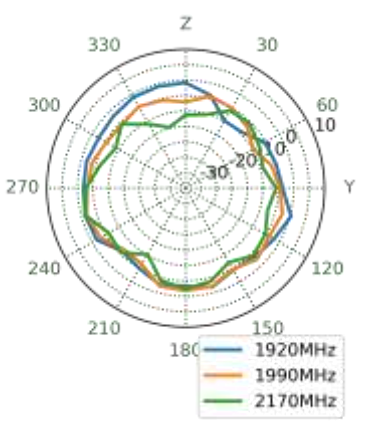

2595MHz

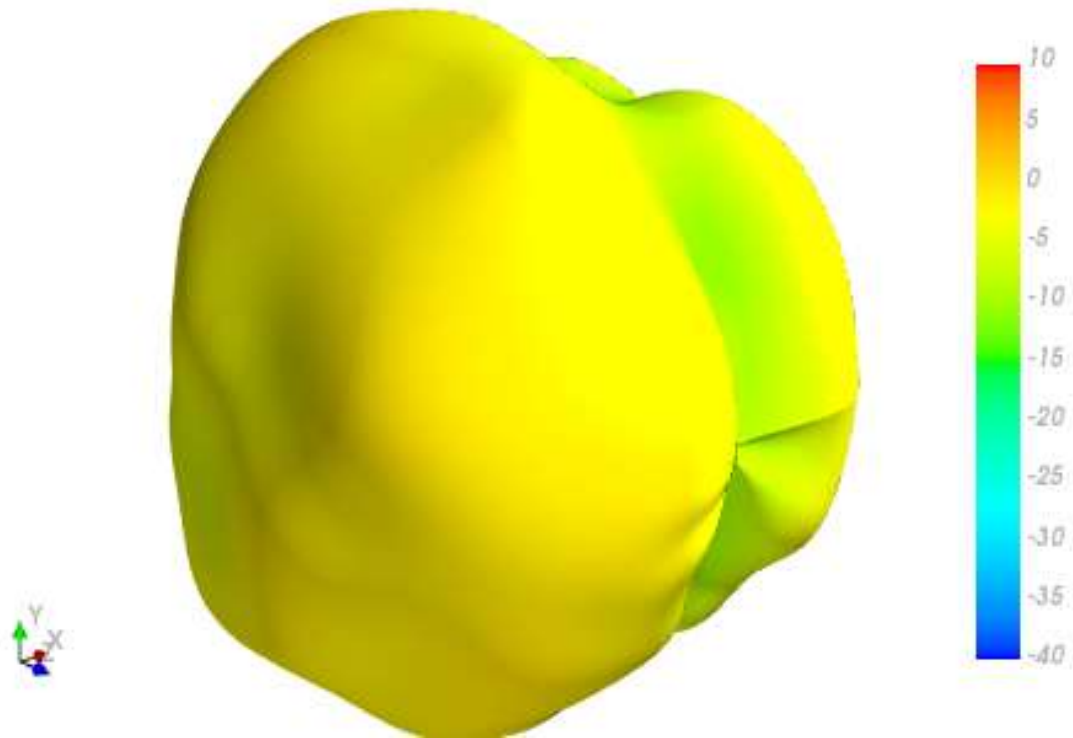

XY Plane

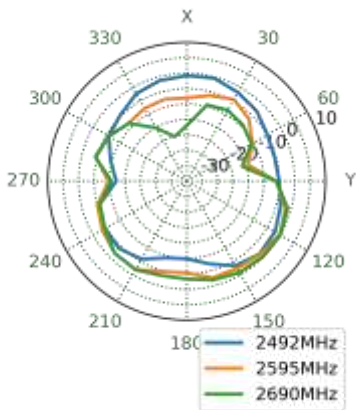

XZ Plane

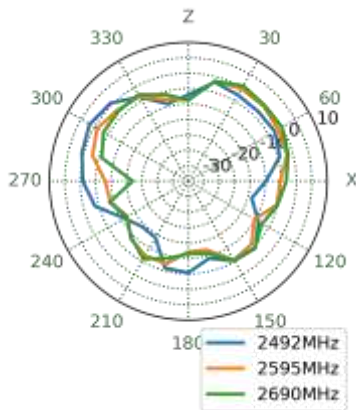

YZ Plane

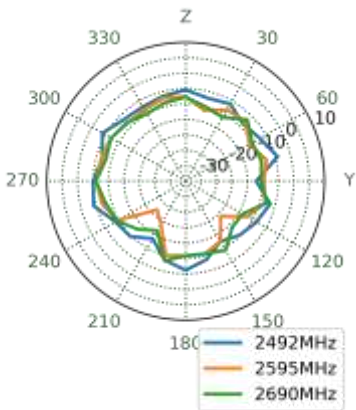

4.3 4G MIMO 2 - 3D and 2D Radiation Patterns

652MHz

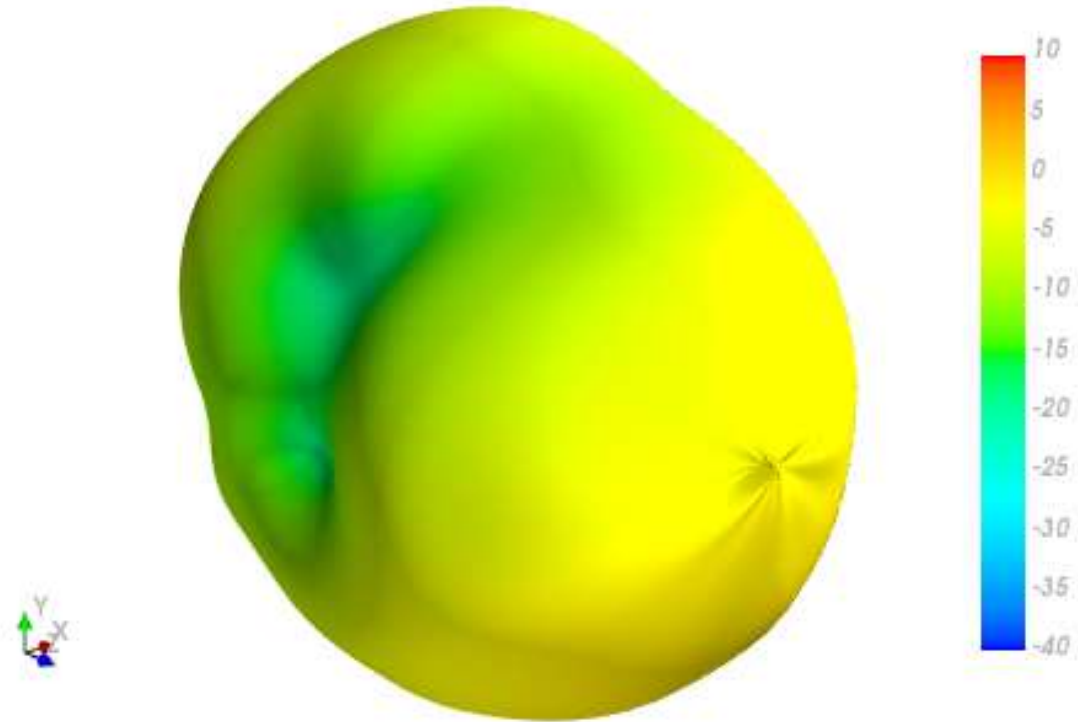

XY Plane

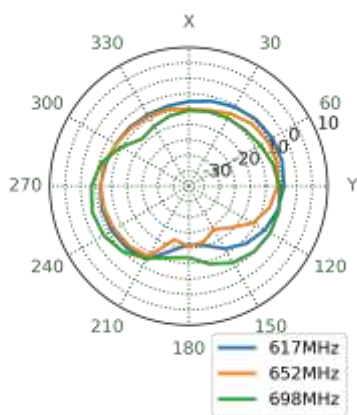

XZ Plane

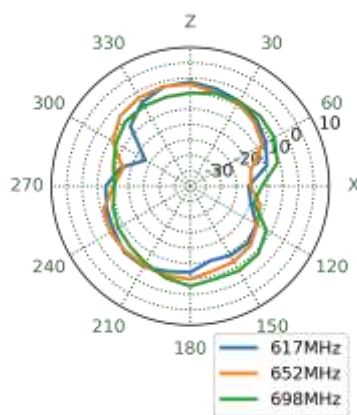

YZ Plane

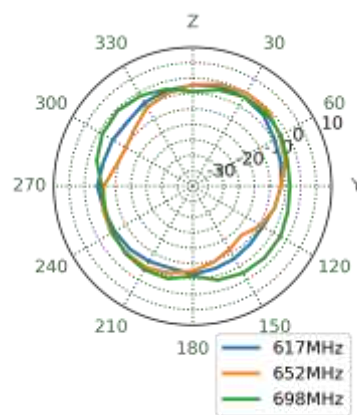

751MHz

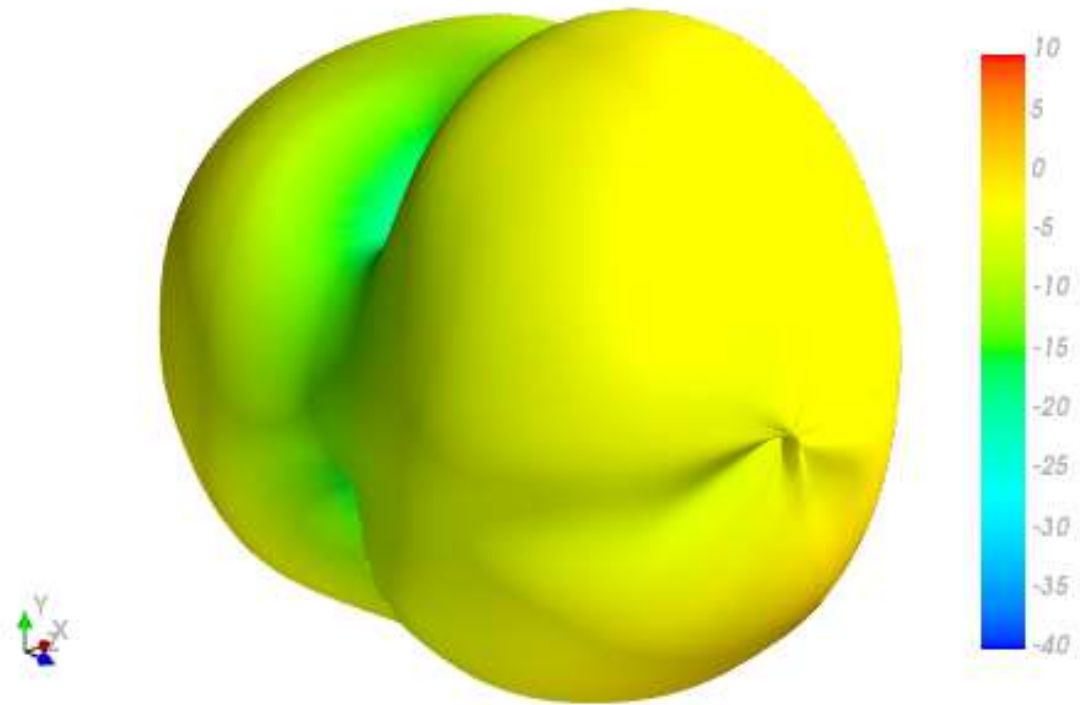

XY Plane

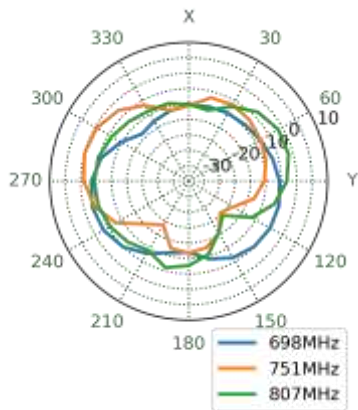

XZ Plane

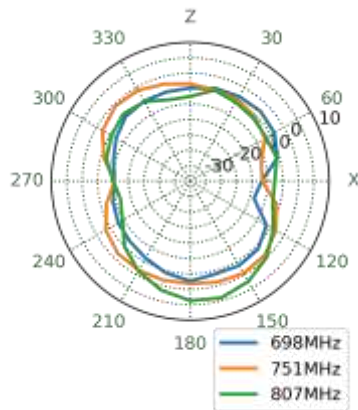

YZ Plane

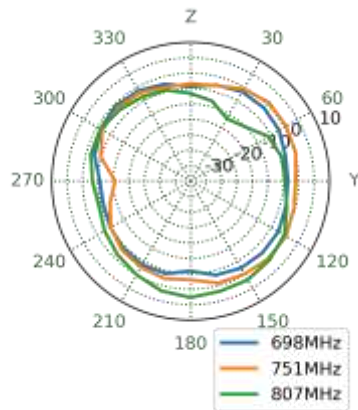

890MHz

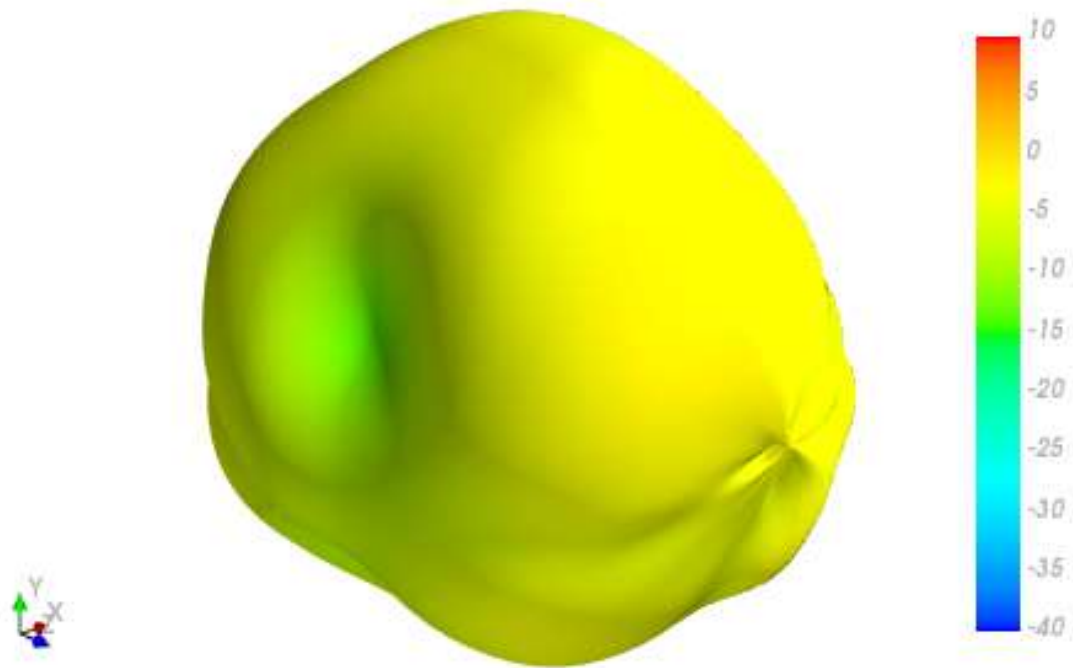

XY Plane

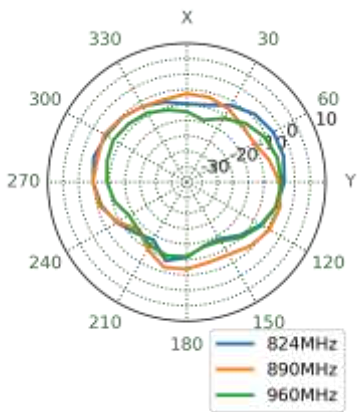

XZ Plane

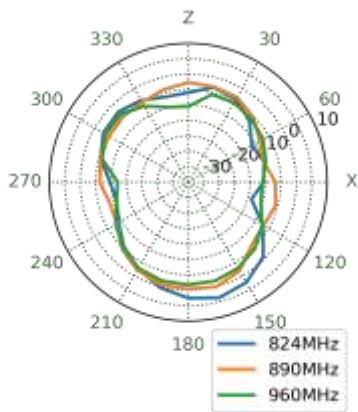

YZ Plane

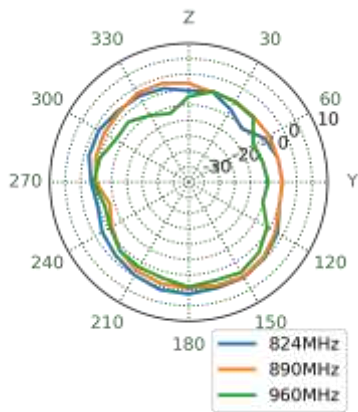

1470MHz

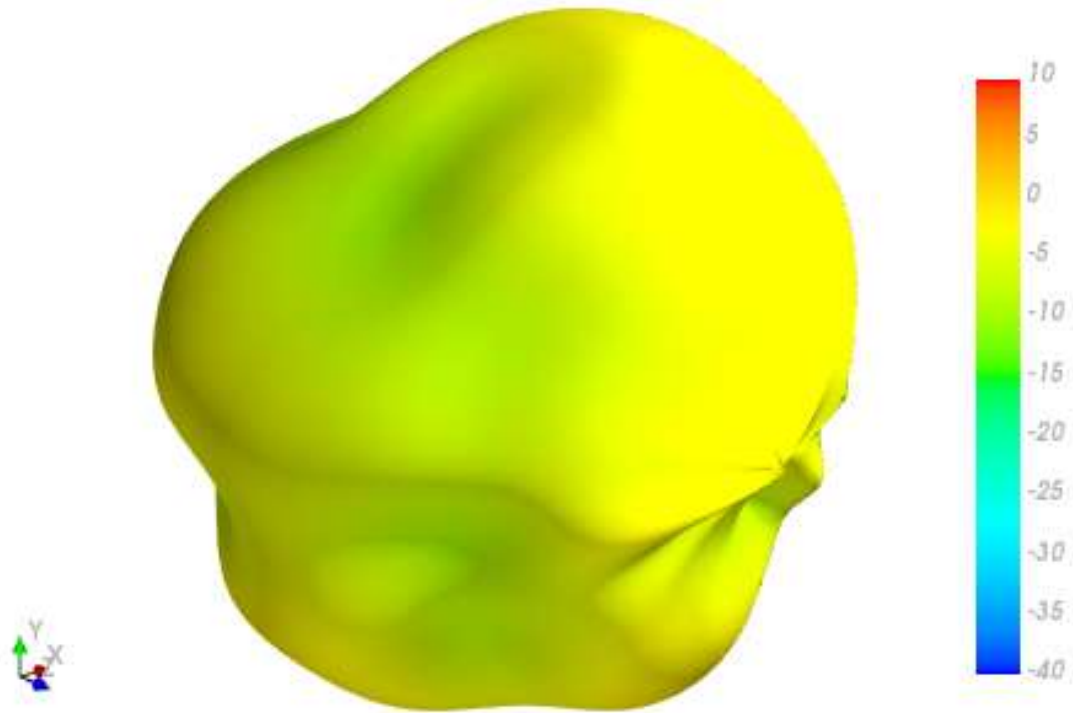

XY Plane

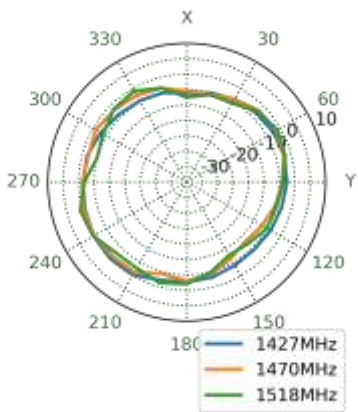

XZ Plane

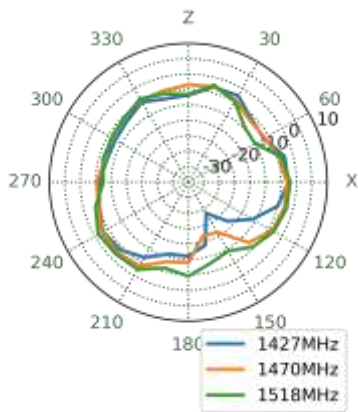

YZ Plane

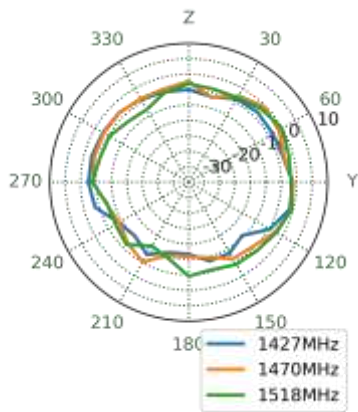

1805MHz

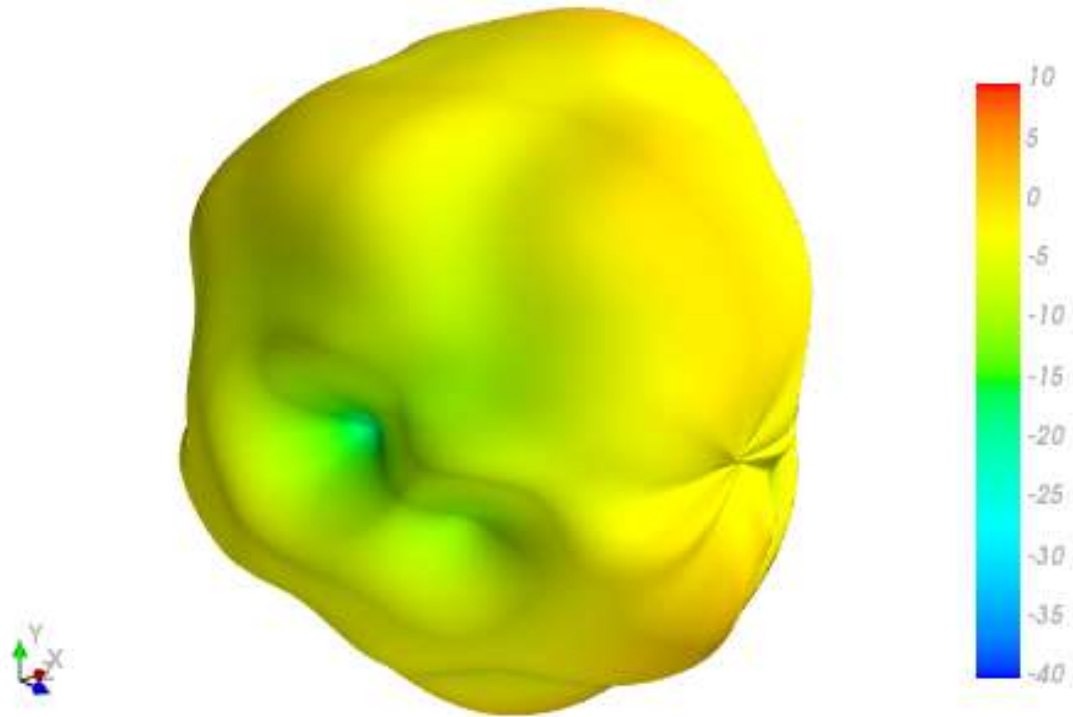

XY Plane

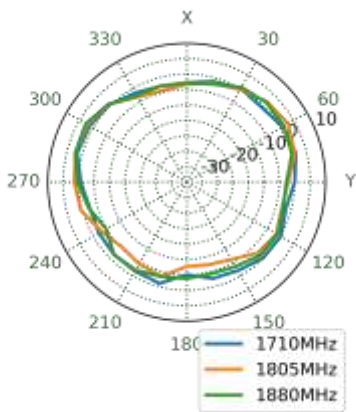

XZ Plane

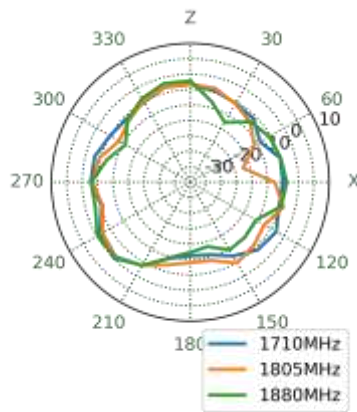

YZ Plane

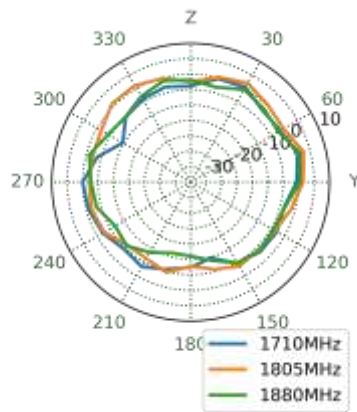

1920MHz

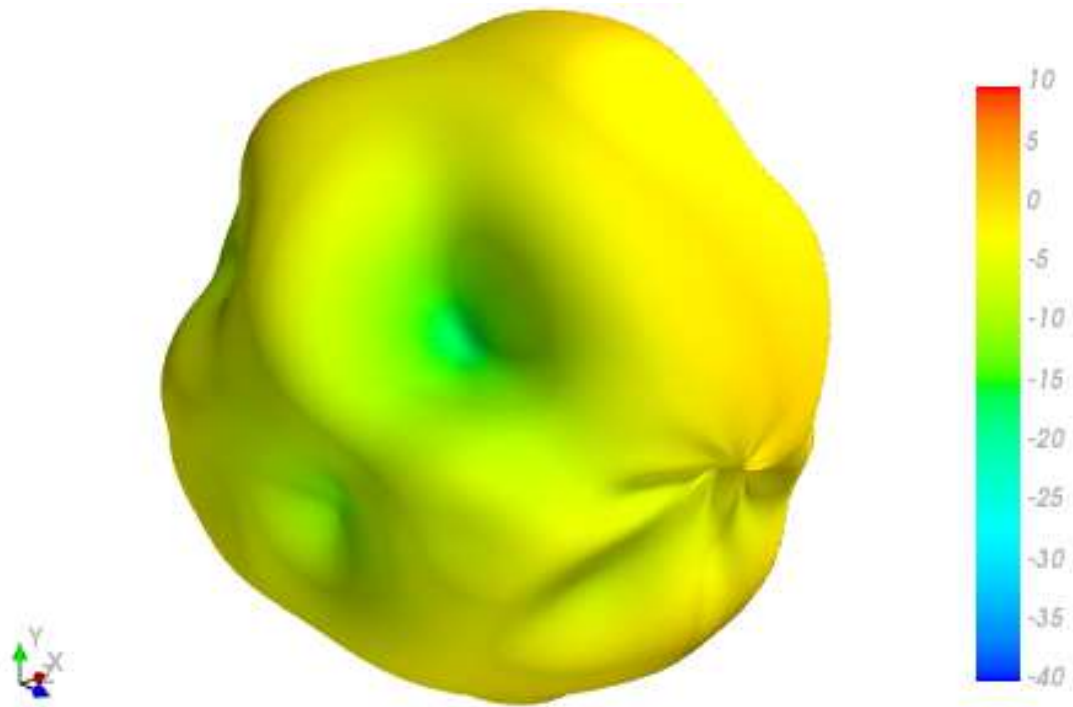

XY Plane

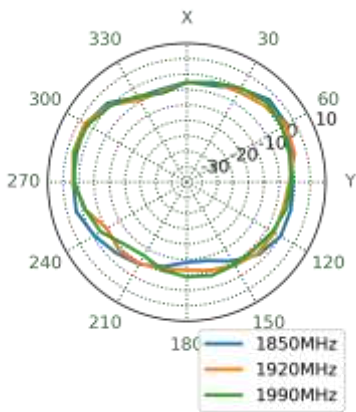

XZ Plane

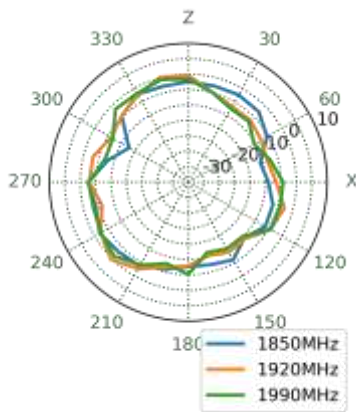

YZ Plane

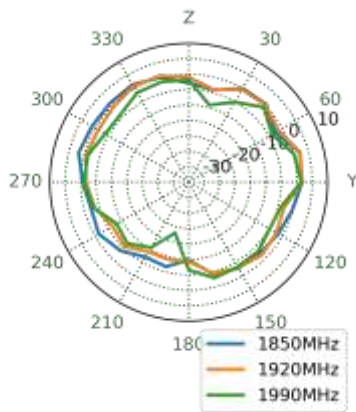

1990MHz

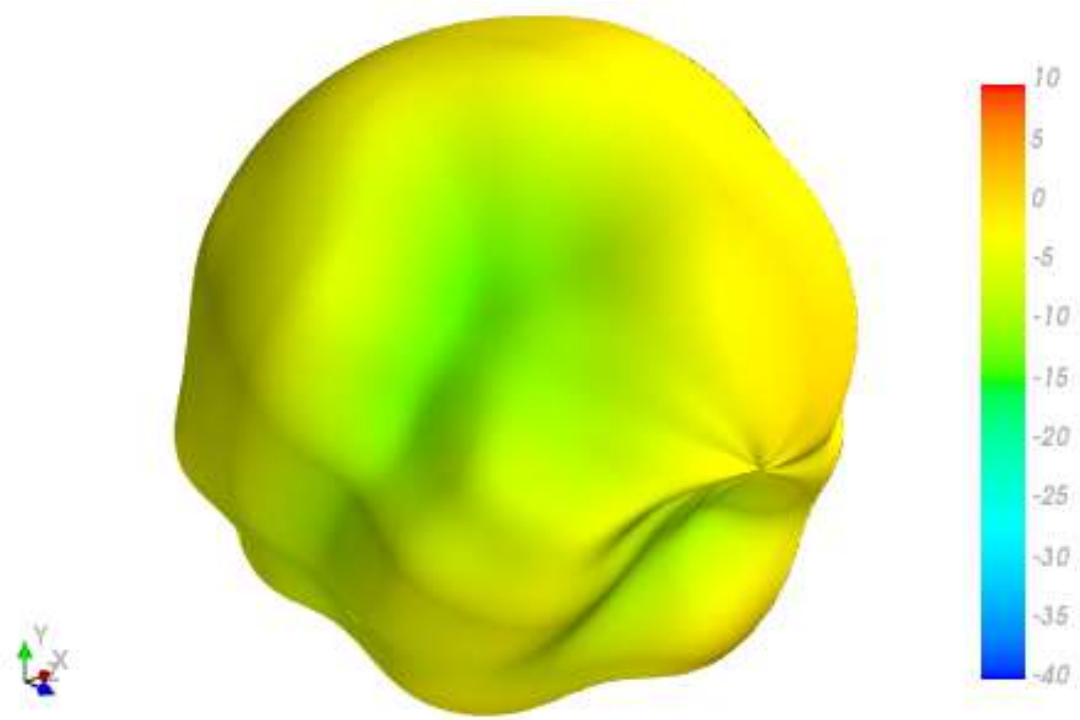

XY Plane XZ Plane YZ Plane

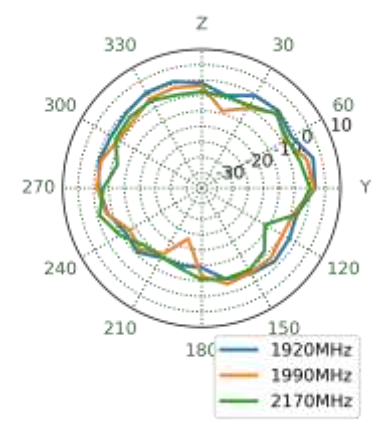
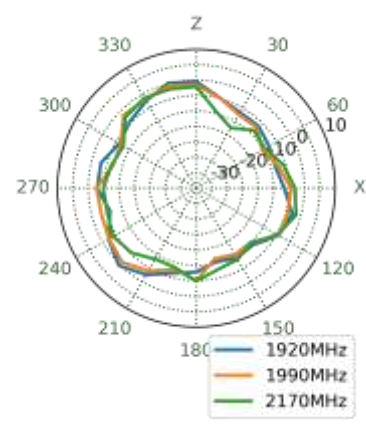
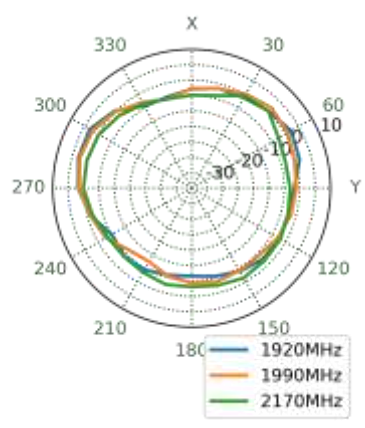

2595MHz

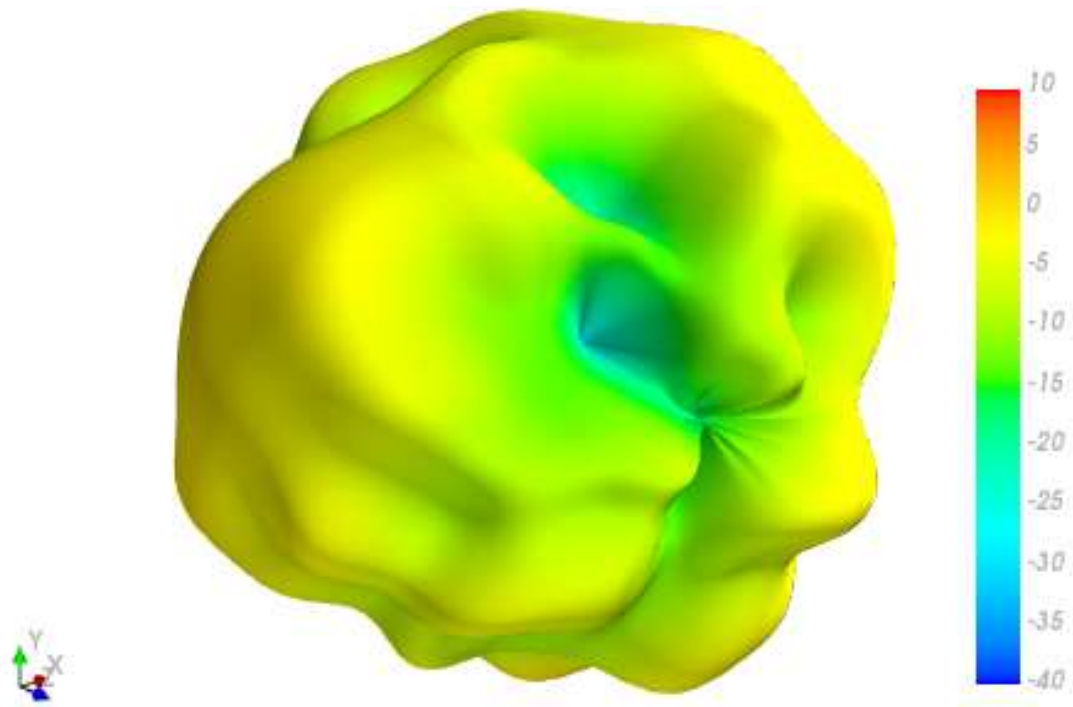

XY Plane

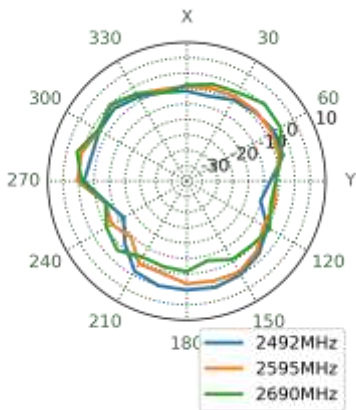

XZ Plane

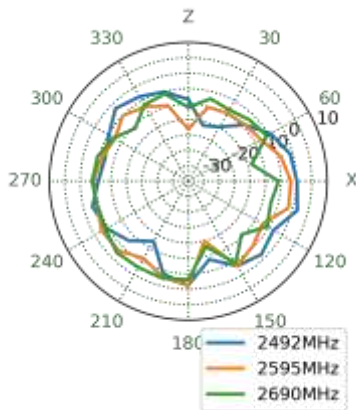

YZ Plane

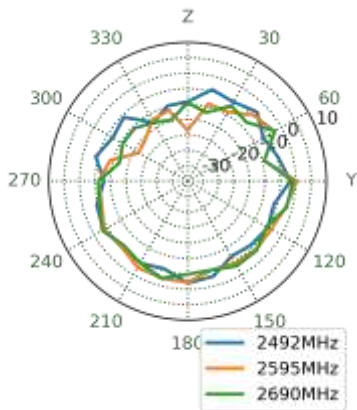

6. Mechanical Drawing (Units: mm)

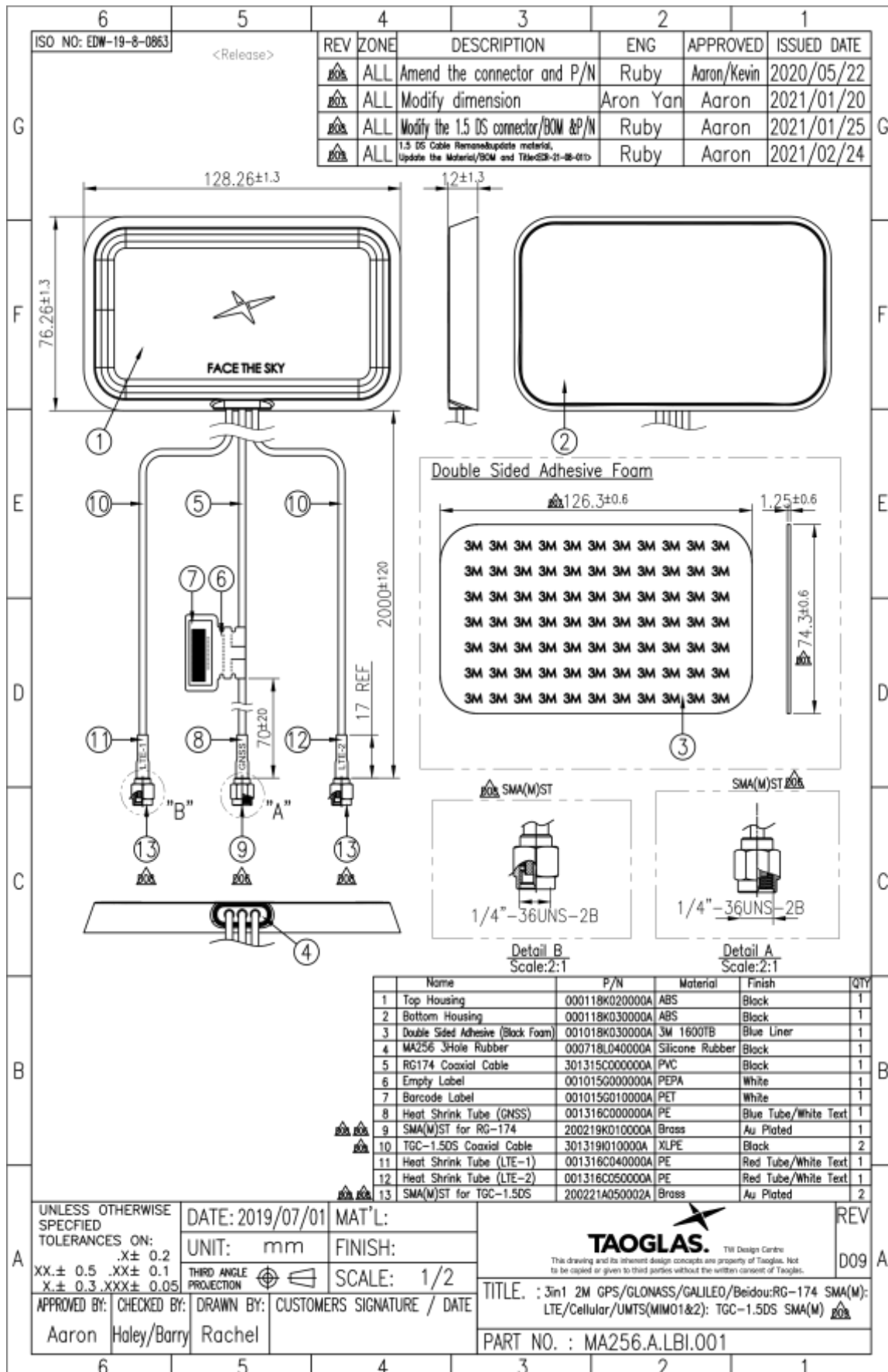

7. Packaging

1pcs MA256.A.LBI.001 per PE Bag
 Dimensions - 300*200
 Weight - 140g

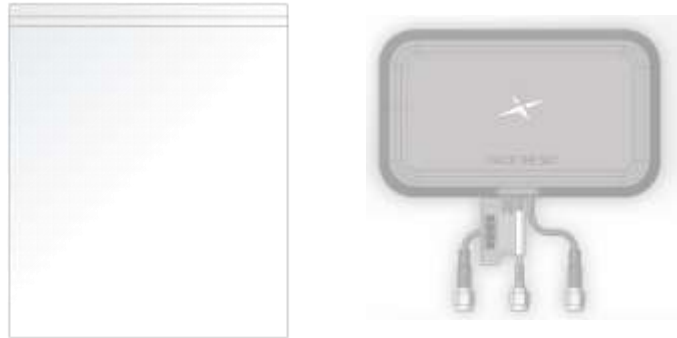

40pcs MA256.A.LBI.001 per carton
 Dimensions - 740*370*300mm
 Weight - 8.7Kg

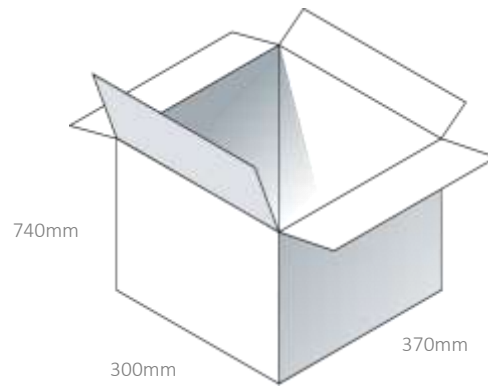

Pallet Dimensions:
 1500*1200*1000mm
 12 Cartons Per Pallet
 6 Cartons Per Layer
 2 Layers

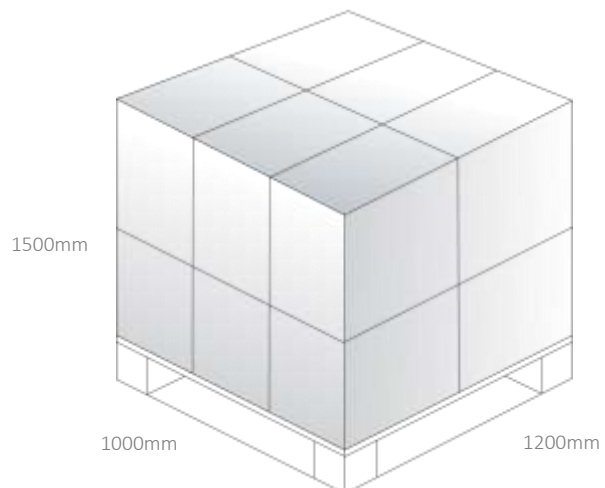

8. Application Note

8.1 Efficiency – MIMO 1

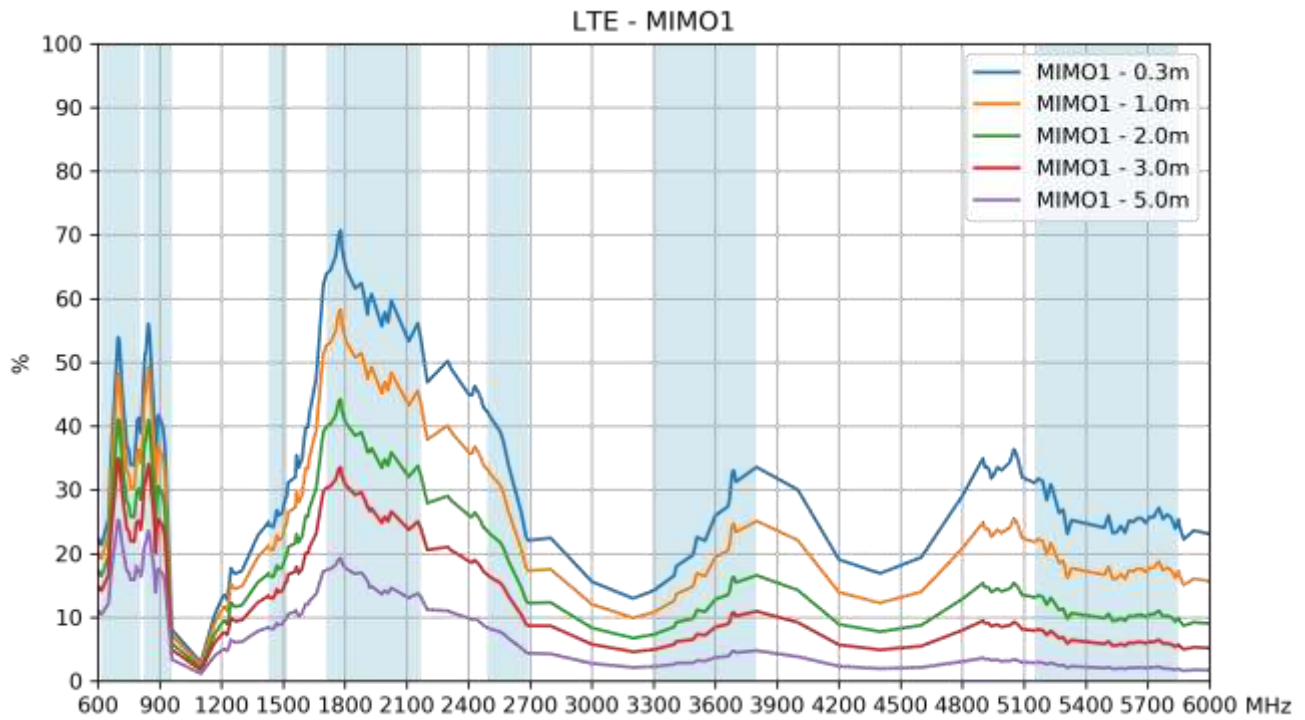

8.2 Efficiency – MIMO 2

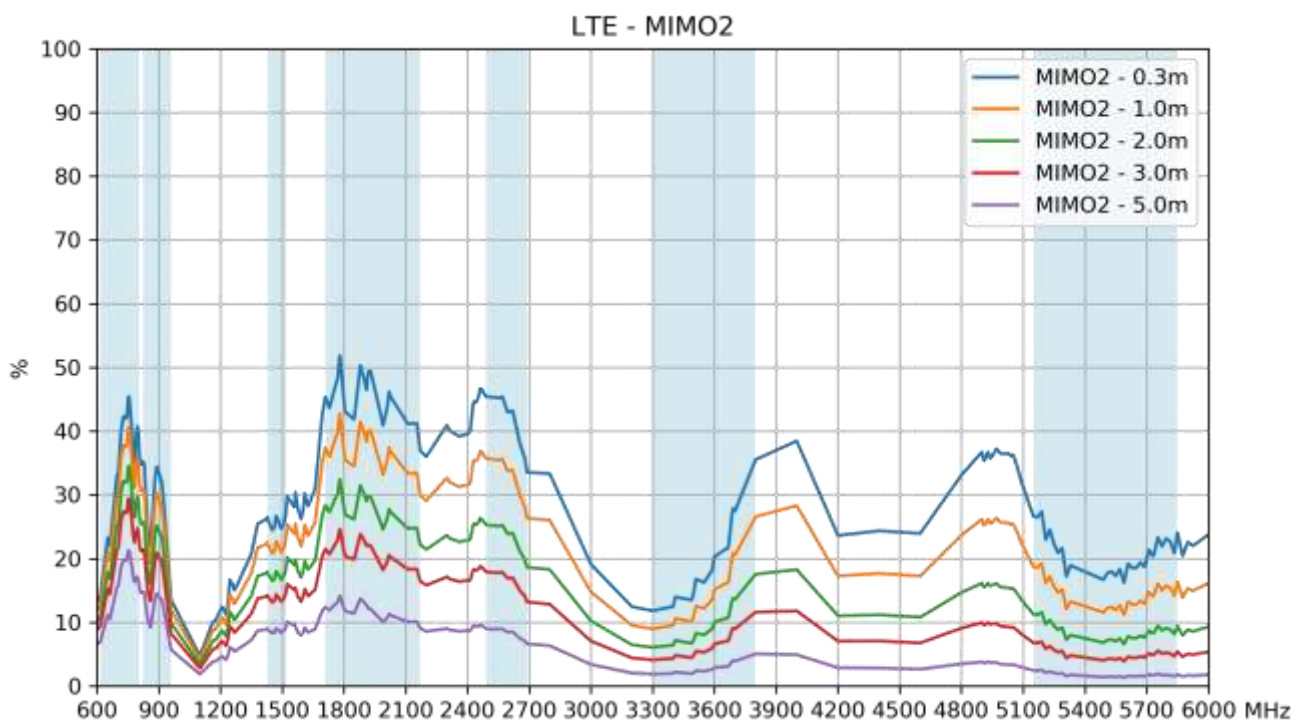

8.3 Average Gain – MIMO 1

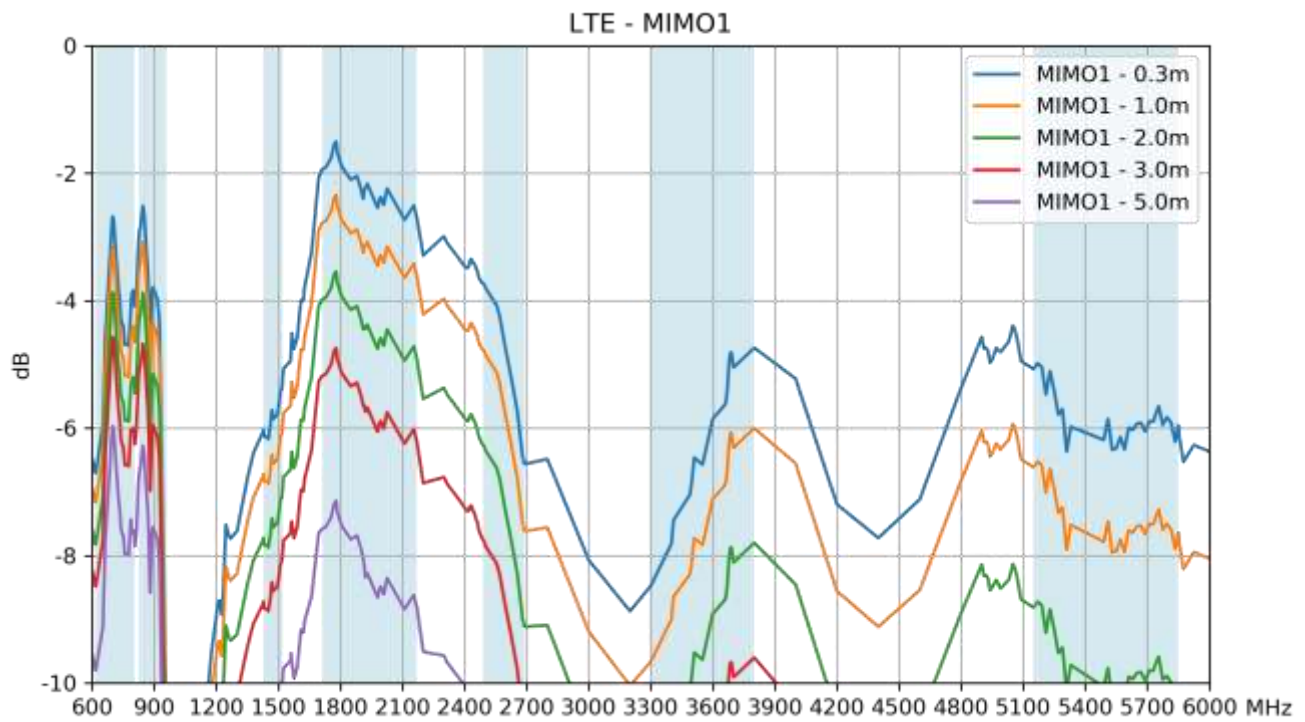

8.4 Average Gain – MIMO 2

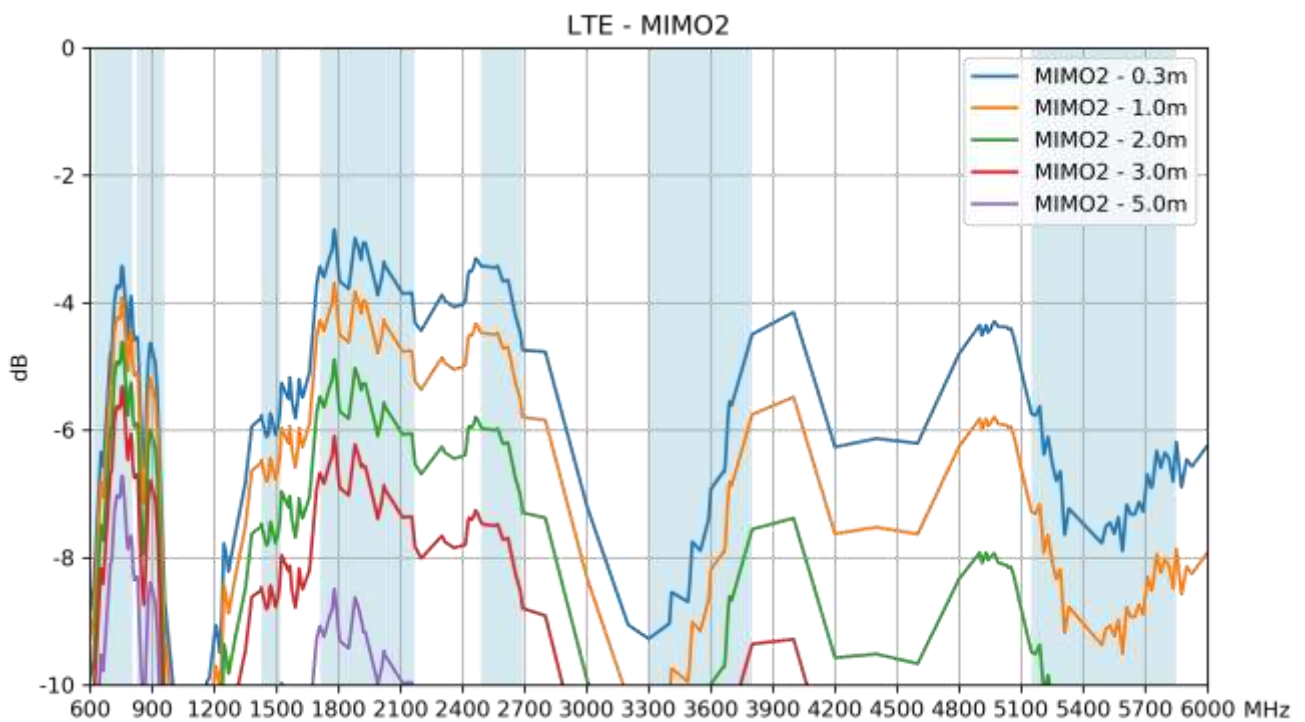

8.5 Peak Gain – MIMO 1

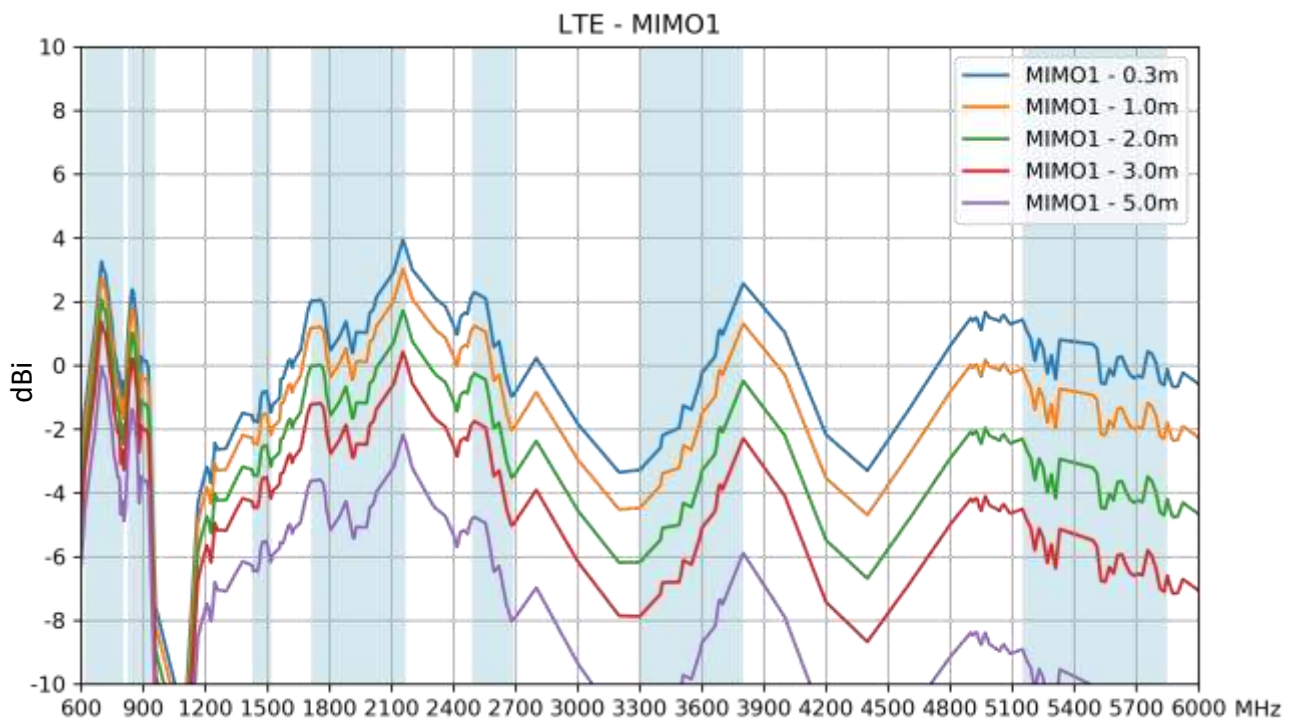

8.6 Peak Gain – MIMO 2

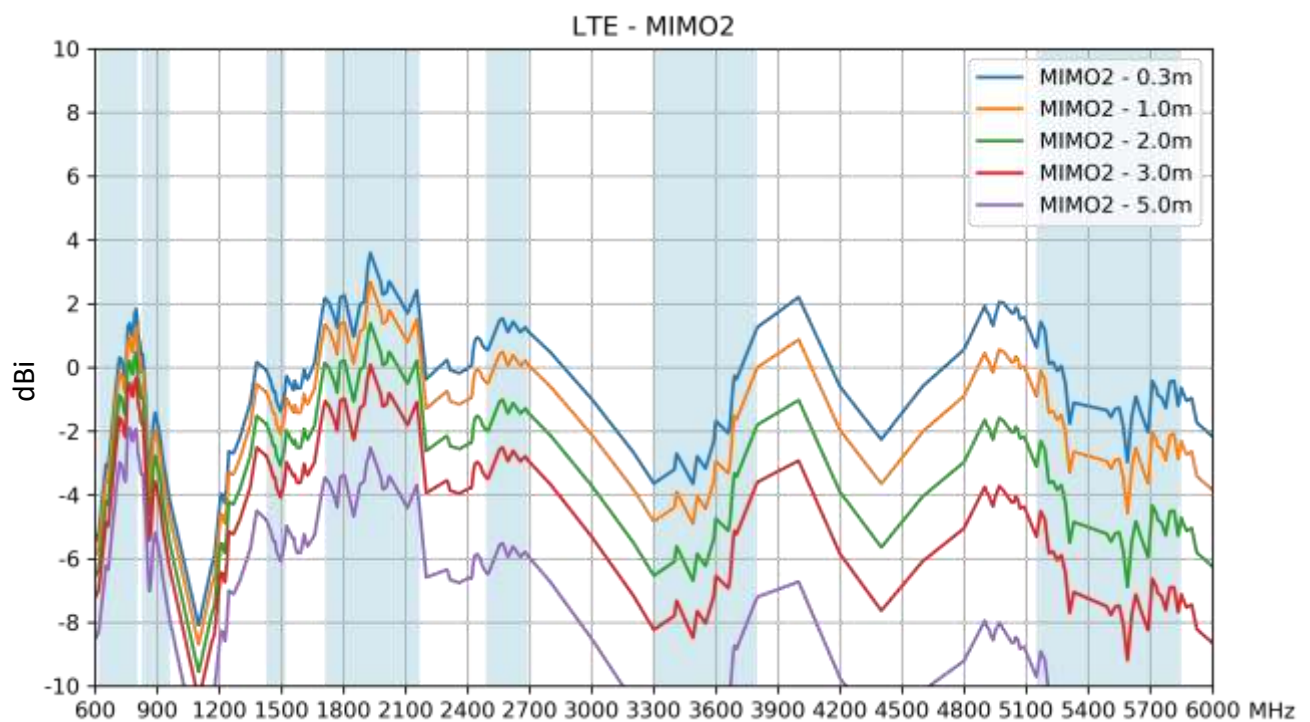

Changelog for the datasheet

SPE-19-8-144 – MA256.A.LBI.001

Revision: B (Current Version)

Date:	2021-02-25
Changes:	Name updated, cable updated ECR-21-08-011
Changes Made by:	Jack Conroy

Previous Revisions

Revision: A (Original First Release)

Date:	2019-11-15
Notes:	
Author:	Jack Conroy



TAOGLAS®

www.taoglas.com

