

SPECIFICATION

PATENTED

- Part No. : **TG.30.8112**
- Product Name : Apex Black Right Angle TG.30
Ultra-Wideband 4G LTE Antenna
- Feature : LTE / GSM / CDMA /DCS /PCS / WCDMA / UMTS /
HSDPA / GPRS / EDGE /GPS /Wi-Fi
698MHz to 960MHz, 1575.42MHz,
1710MHz to 2700Mhz
Patented
Typical 70%+ Efficiency and 3dBi+ Peak Gain
Dipole Swivel Terminal Antenna
90° termination with SMA(M) Connector
UV Resistant, IP65 Rated Waterproof Enclosure
RoHS Compliant



1. Introduction

The Apex TG.30 is an omnidirectional 4G LTE antenna. This fixed 90 degree, connector mount, dipole antenna is primarily designed for use with 4G LTE modules and devices that require the highest possible efficiency and peak gain in order to deliver best-in-class throughput. Ideal for all major worldwide cellular bands, it is perfect for access points, terminals, and routers. The antenna is ground plane independent with an SMA(M) connector and is backward compatible with 3G/2G cellular applications such as GSM, LTE, UMTS, Wi-Fi, and even GPS bands for Assisted GPS and/or E911 applications. With very high efficiency on all global cellular bands, it is an ideal solution for any device requiring reliable performance. It is also guaranteed to meet any type of approval or carrier certification requirements from an RF standpoint.

The Apex TG.30 has a robust, UV-resistant, IP65 rated waterproof enclosure that has been designed so the TG.30 can be used in challenging environments. This patented antenna is available in both white and black versions, and it is also available with straight and rotatable connectors. For more information, contact your regional Taoglas customer support teams.

2. Specification

ELECTRICAL							
Frequency (MHz)	700~800	824~960	1575.42	1710 ~ 1880	1850 ~ 1990	1710 ~ 2170	2400~2700
Peak Gain (dBi)							
Free Space	2.7	2.1	0.3	3.5	3.6	3.6	5.3
30x30cm GP center	4.3	5.3	5.3	6.7	6.8	7.5	8.1
30x30cm GP edge	4.4	2.4	0.5	1.9	2.0	2.5	3.2
PCB edge	3.2	1.9	2.4	3.2	3.3	3.6	4.7
Average Gain							
Free Space	-0.7	-1.2	-1.2	-0.4	-0.4	-0.2	-0.6
30x30cm GP center	-2.8	-1.0	-2.4	-1.6	-1.8	-1.3	-1.2
30x30cm GP edge	-0.1	-4.3	-2.5	-2.0	-2.0	-2.0	-2.2
PCB edge	0.8	-1.9	-0.9	-0.6	-0.6	-0.6	-0.8
Efficiency							
Free Space	85%	75%	76%	90%	90%	90%	87%
30x30cm GP center	52%	39%	57%	70%	65%	74%	75%
30x30cm GP edge	91%	64%	56%	62%	62%	63%	60%
PCB edge	86%	87%	81%	86%	86%	86%	84%
Impedance	50Ω						
Polarization	Linear						
Radiation Pattern	Omni						
Input Power	10 W						
MECHANICAL							
Casing	UV Resistant PC/ABS						
Connector	SMA Male						
IP Rating	IP65						
ENVIRONMENTAL							
Temperature Range	-40°C to 85°C						
Humidity	Non-condensing 65°C 95% RH						

LTE BANDS			
Band Number	LTE / LTE-Advanced / WCDMA / HSPA / HSPA+ / TD-SCDMA		
	Uplink	Downlink	Covered
1	UL: 1920 to 1980	DL: 2110 to 2170	✓
2	UL: 1850 to 1910	DL: 1930 to 1990	✓
3	UL: 1710 to 1785	DL: 1805 to 1880	✓
4	UL: 1710 to 1755	DL: 2110 to 2155	✓
5	UL: 824 to 849	DL: 869 to 894	✓
7	UL: 2500 to 2570	DL: 2620 to 2690	✓
8	UL: 880 to 915	DL: 925 to 960	✓
9	UL: 1749.9 to 1784.9	DL: 1844.9 to 1879.9	✓
11	UL: 1427.9 to 1447.9	DL: 1475.9 to 1495.9	✗
12	UL: 699 to 716	DL: 729 to 746	✓
13	UL: 777 to 787	DL: 746 to 756	✓
14	UL: 788 to 798	DL: 758 to 768	✓
17	UL: 704 to 716	DL: 734 to 746 (LTE only)	✓
18	UL: 815 to 830	DL: 860 to 875 (LTE only)	✓
19	UL: 830 to 845	DL: 875 to 890	✓
20	UL: 832 to 862	DL: 791 to 821	✓
21	UL: 1447.9 to 1462.9	DL: 1495.9 to 1510.9	✗
22	UL: 3410 to 3490	DL: 3510 to 3590	✗
23	UL: 2000 to 2020	DL: 2180 to 2200 (LTE only)	✓
24	UL: 1625.5 to 1660.5	DL: 1525 to 1559 (LTE only)	✓
25	UL: 1850 to 1915	DL: 1930 to 1995	✓
26	UL: 814 to 849	DL: 859 to 894	✓
27	UL: 807 to 824	DL: 852 to 869 (LTE only)	✓
28	UL: 703 to 748	DL: 758 to 803 (LTE only)	✓
29	UL: -	DL: 717 to 728 (LTE only)	✓
30	UL: 2305 to 2315	DL: 2350 to 2360 (LTE only)	✓
31	UL: 452.5 to 457.5	DL: 462.5 to 467.5 (LTE only)	✗
32	UL: -	DL: 1452 - 1496	✗
35		1850 to 1910	✓
38		2570 to 2620	✓
39		1880 to 1920	✓
40		2300 to 2400	✓
41		2496 to 2690	✓
42		3400 to 3600	✗
43		3600 to 3800	✗

*Covered bands represent an efficiency greater than 20%

3. Antenna Characteristics

3.1 Return Loss

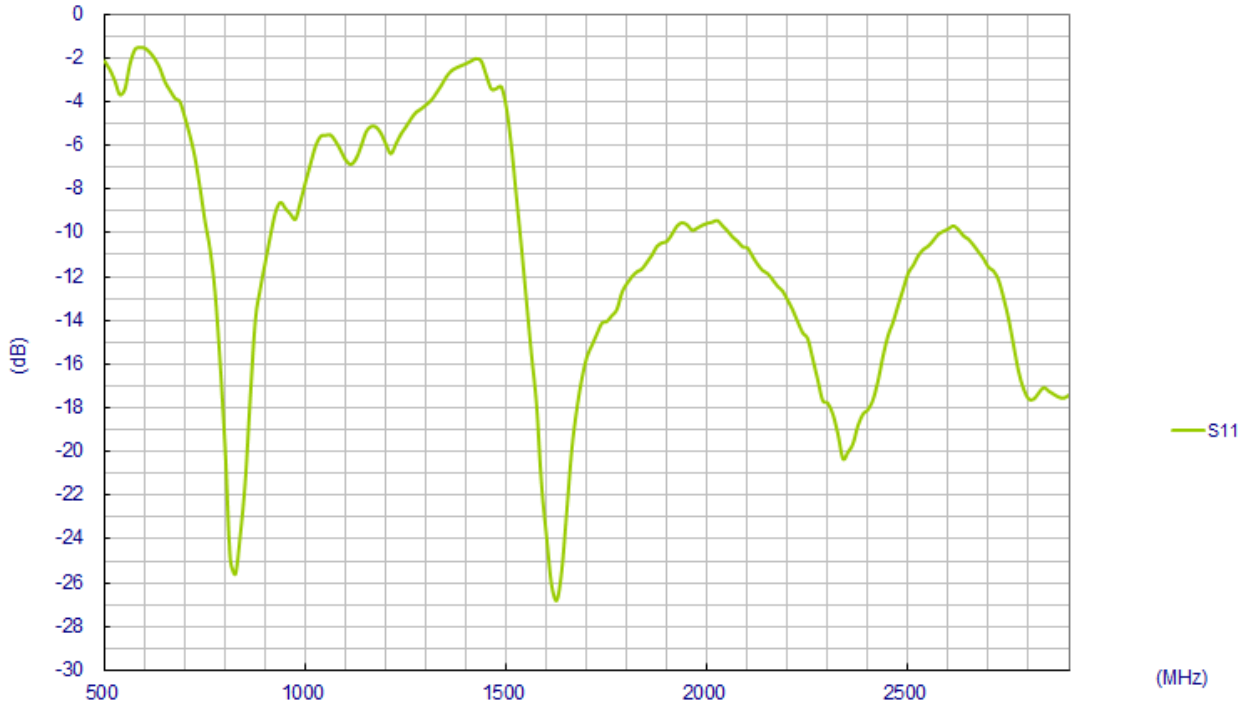

3.2 Peak Gain

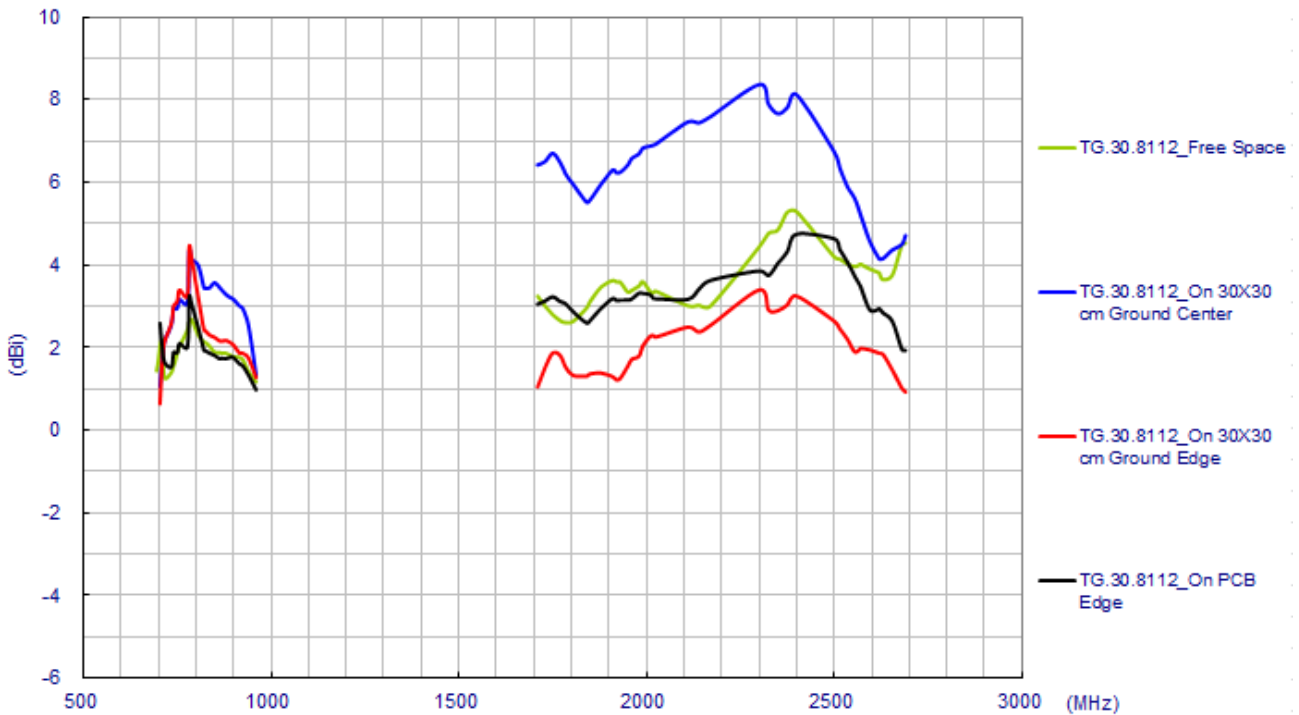

3.3 Average Gain

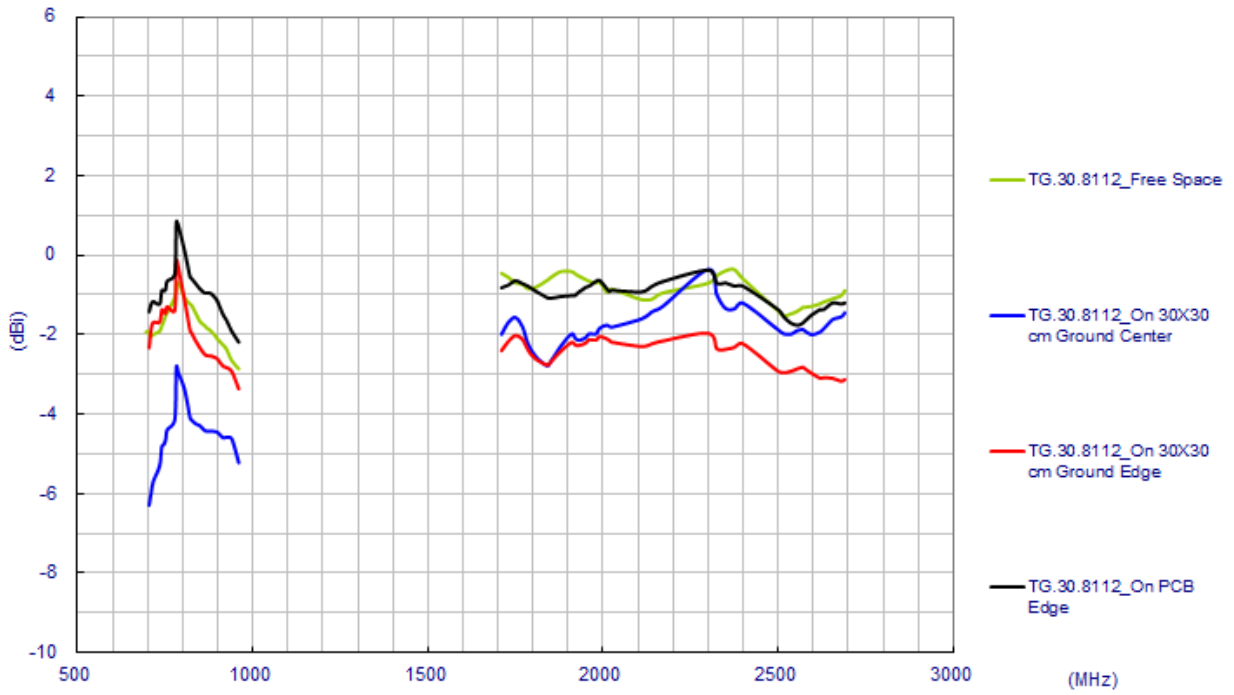

3.4 Efficiency

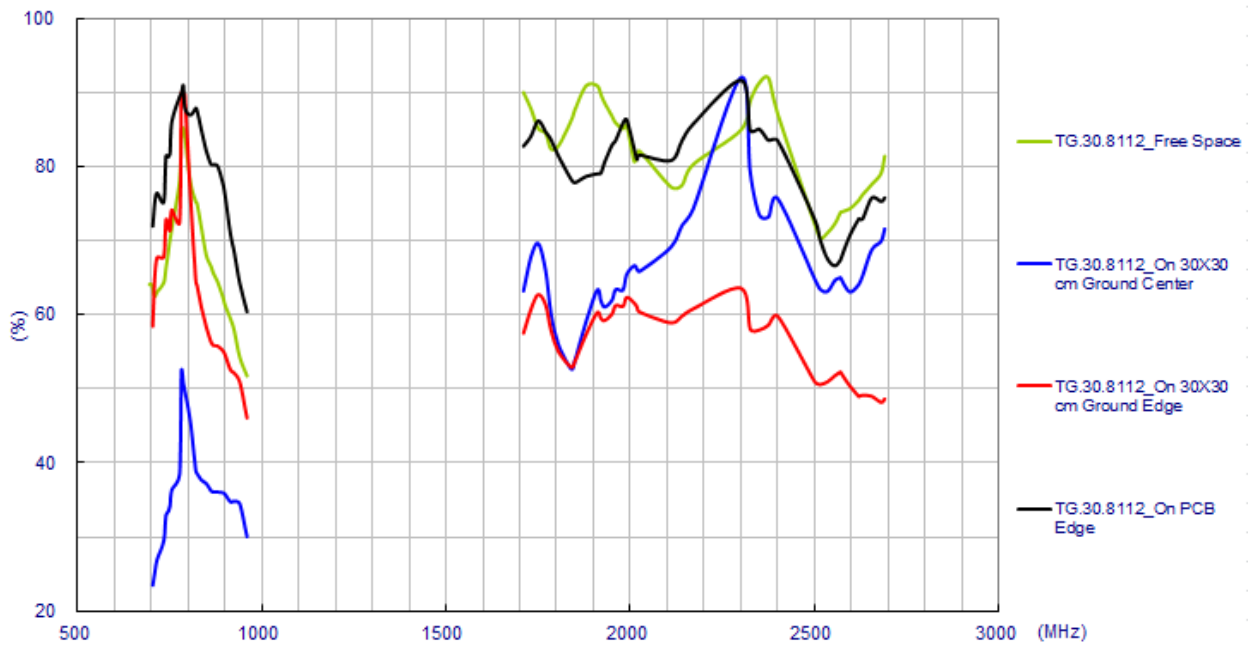

4. Antenna Radiation Patterns

4.1 Antenna setup (Free Space)

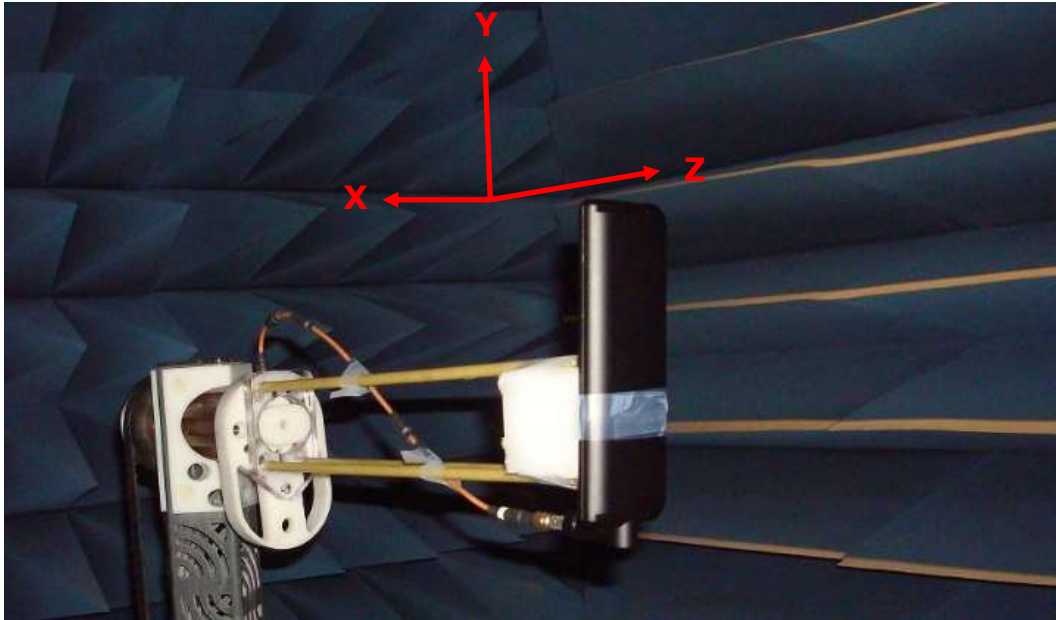

4.2 Radiation Patterns (Free Space)

XY Plane

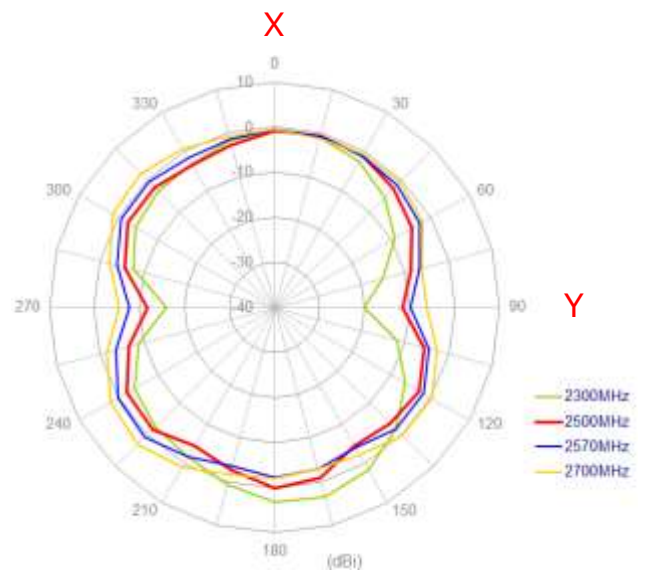
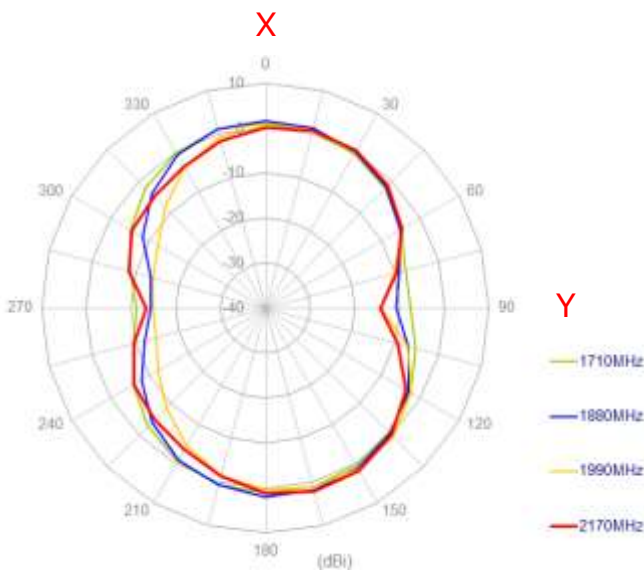
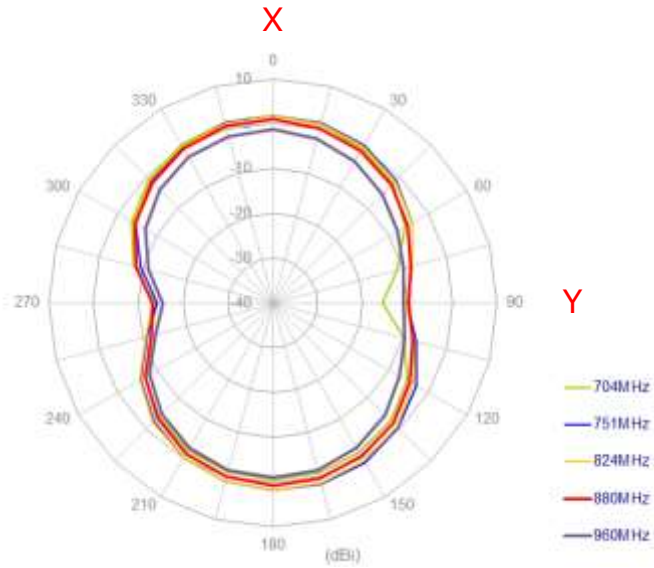

XZ Plane

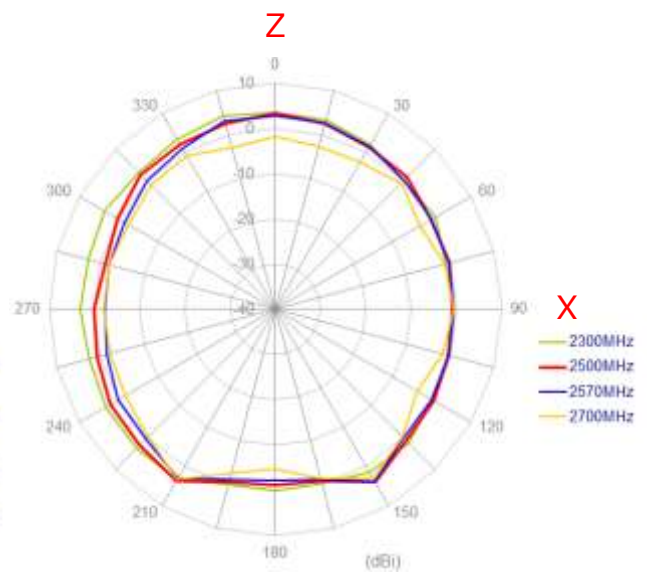
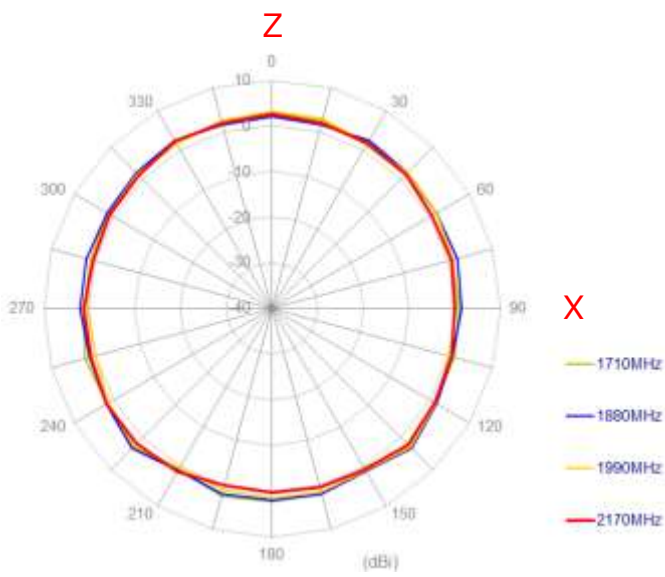
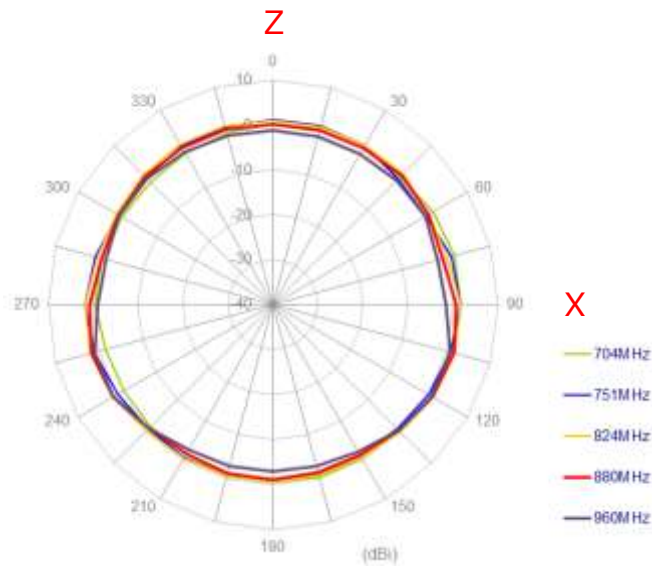

4.3 Antenna setup (On 300x300mm ground center)

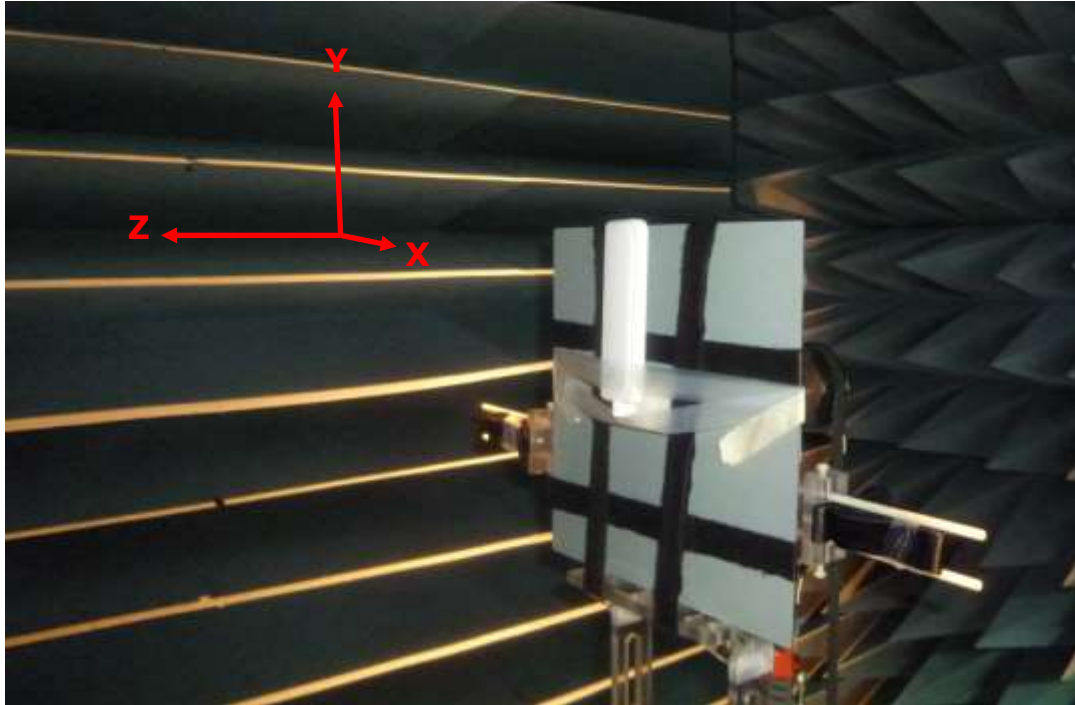

4.4 Radiation Patterns (On 300x300mm ground center)

XY Plane

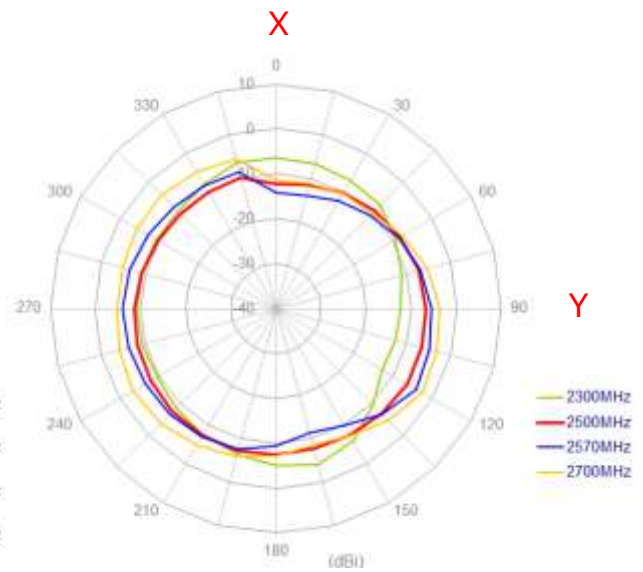
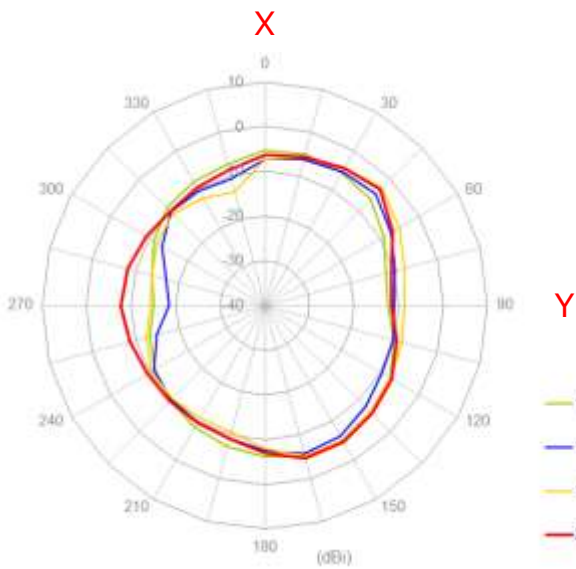
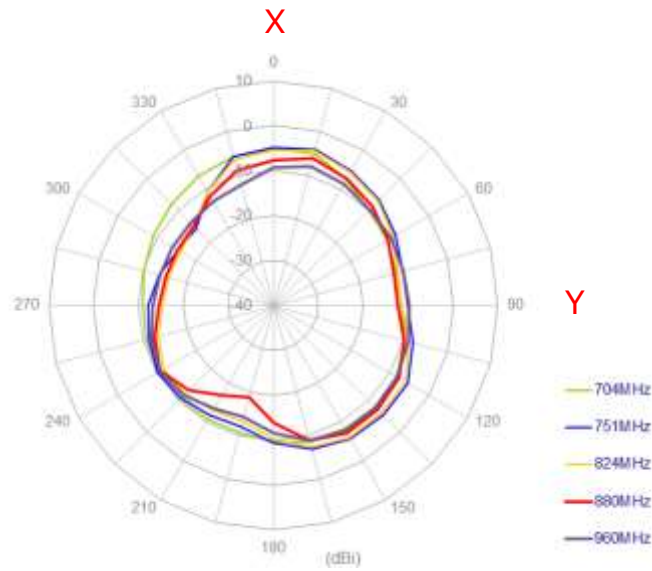

XZ Plane

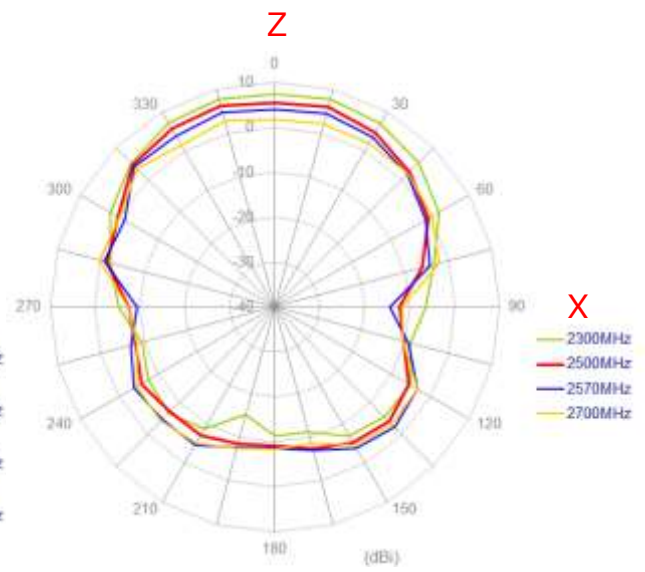
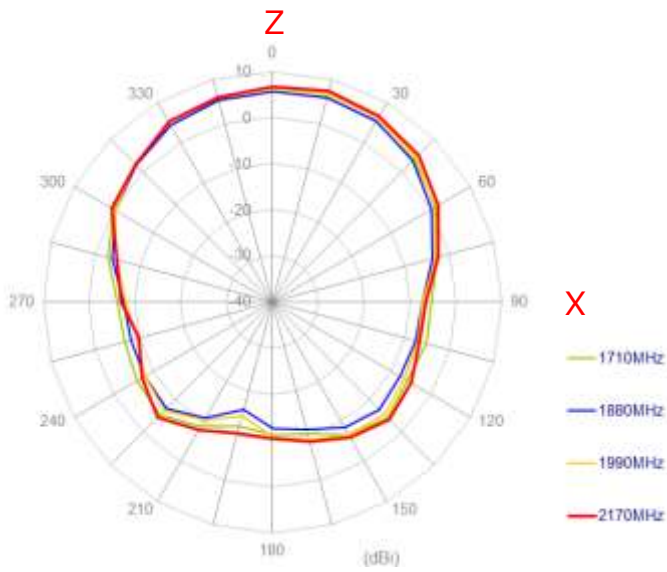
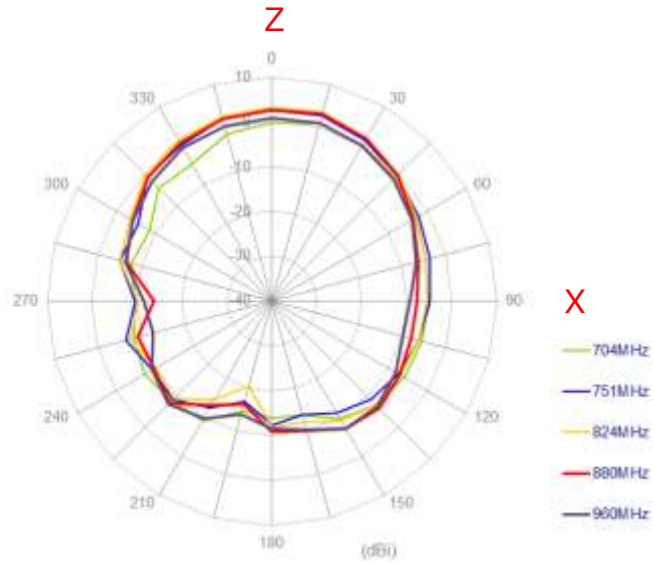

4.5 Antenna setup (On 300x300mm ground edge)

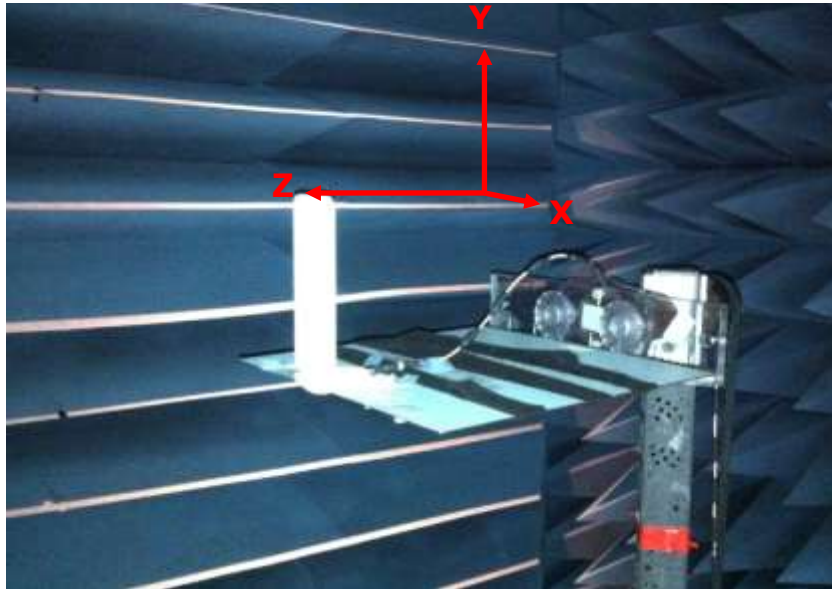

4.6 Radiation Patterns (On 300x300mm ground edge)

XY Plane

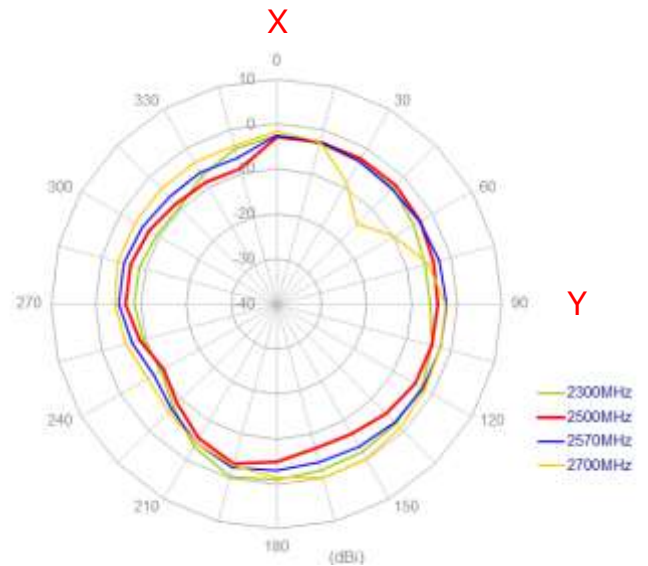
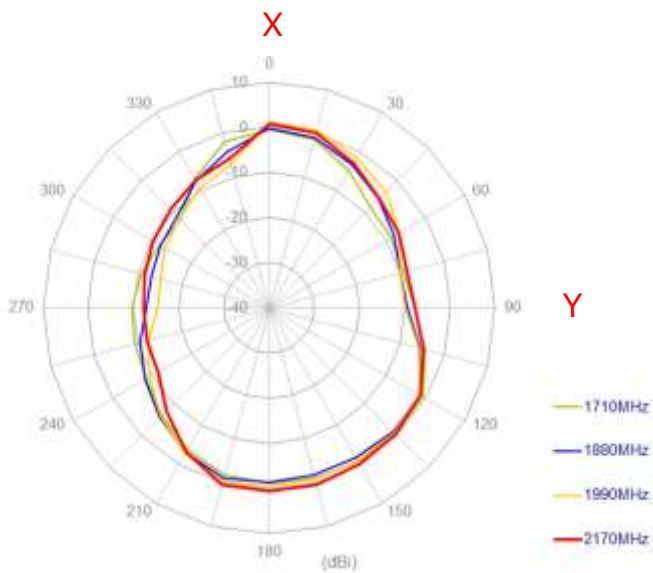
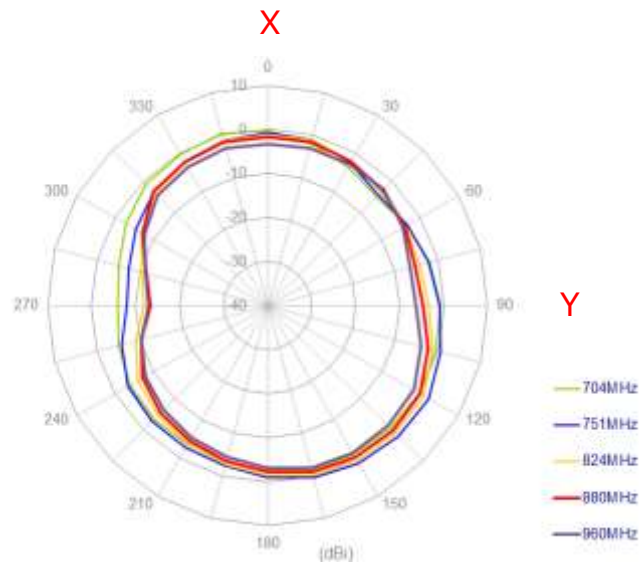

XZ Plane

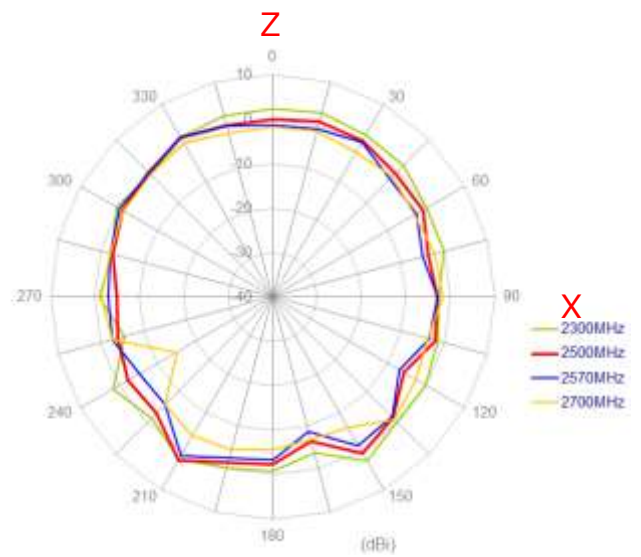
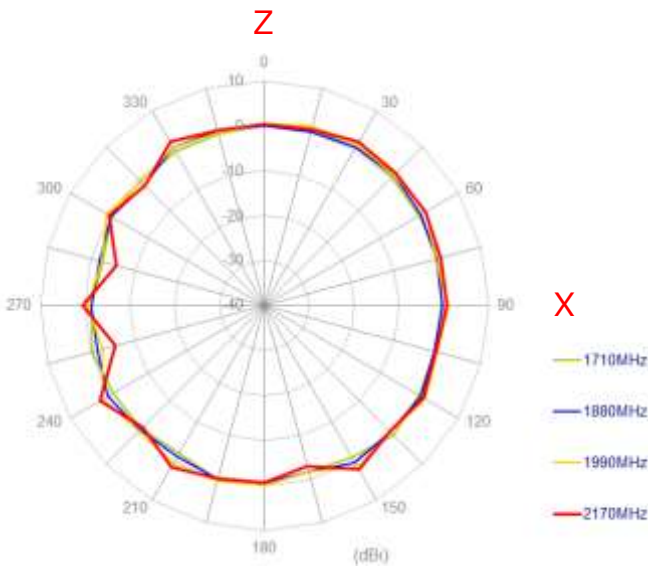
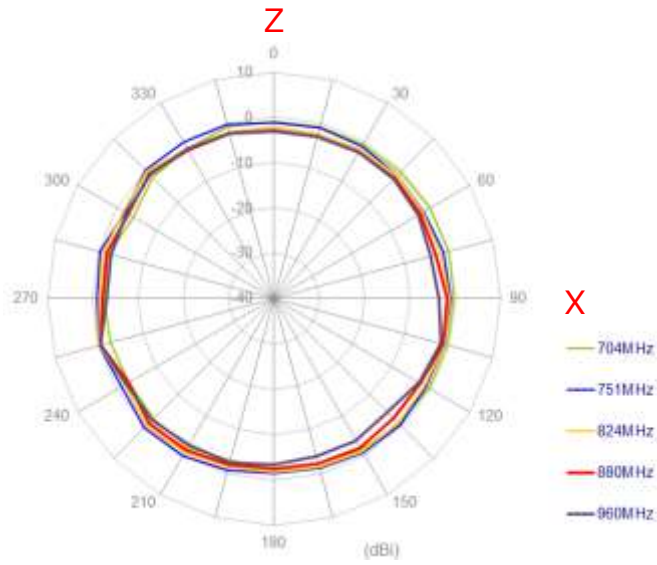

4.7 Antenna setup (On Ground Plane edge)

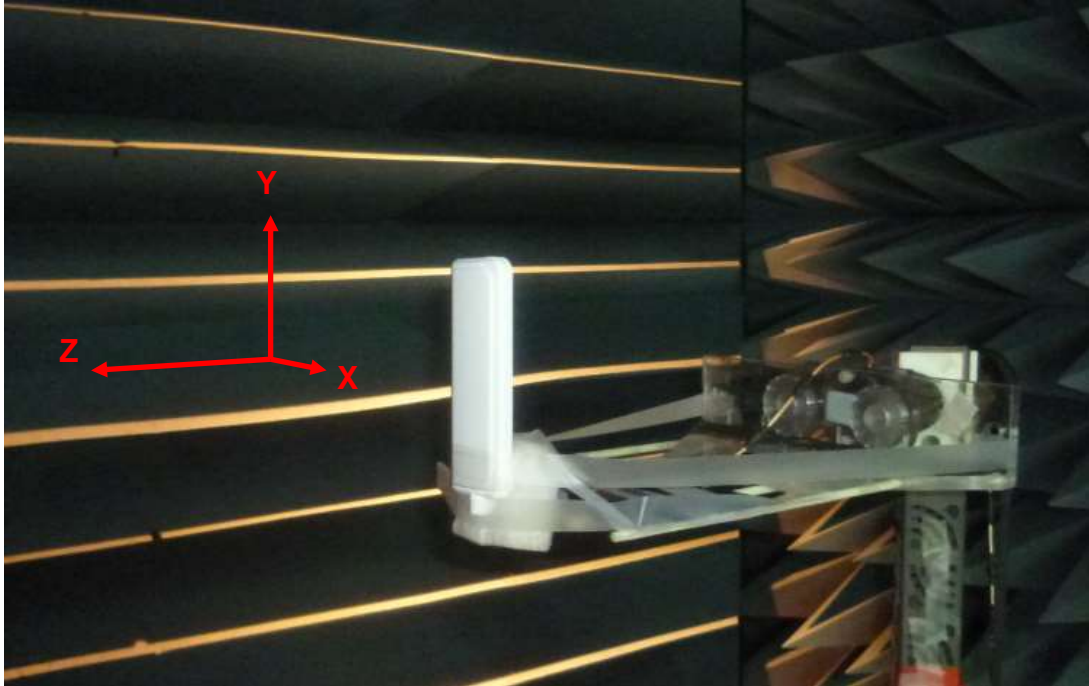

4.8 Radiation Patterns (On Ground Plane edge)

XY Plane

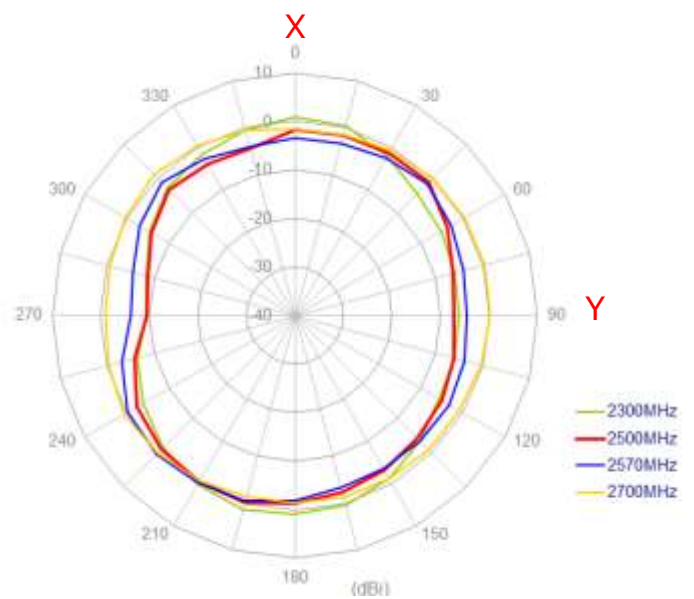
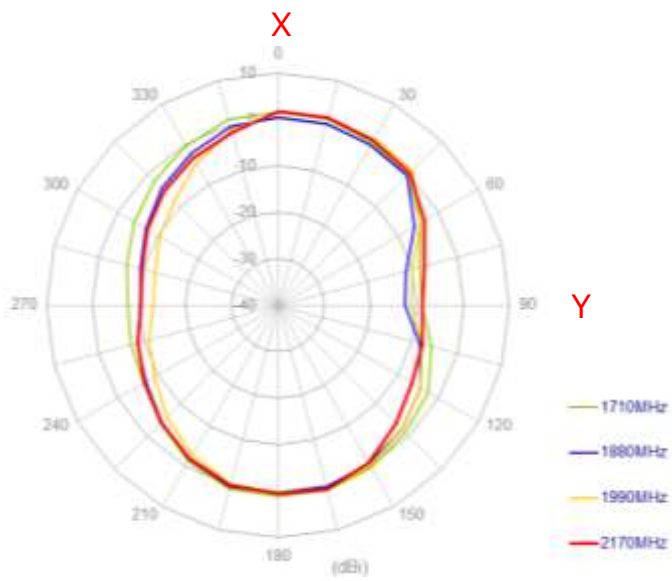
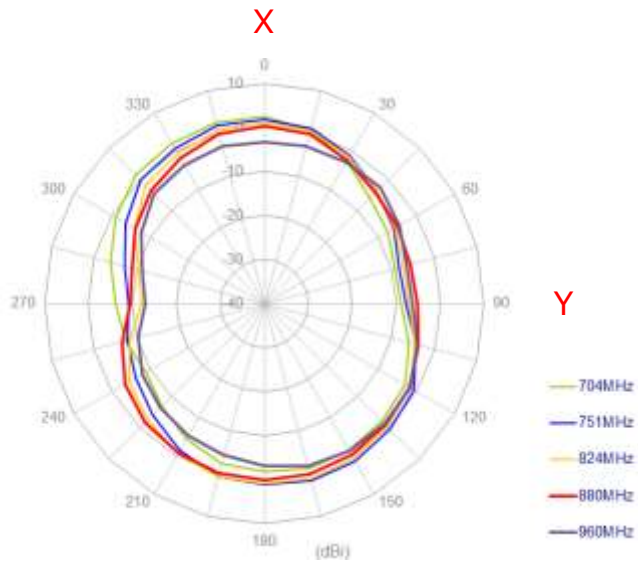

XZ Plane

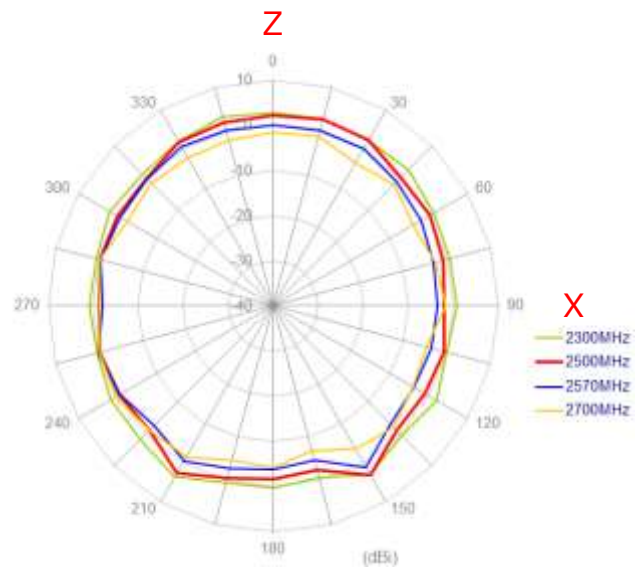
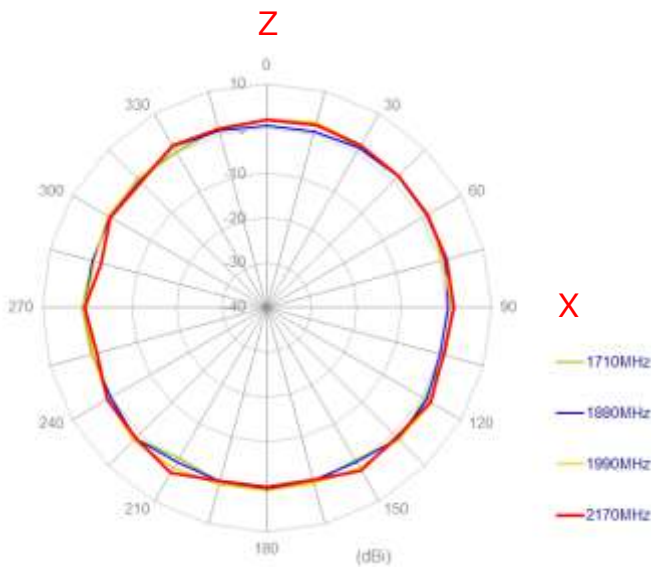
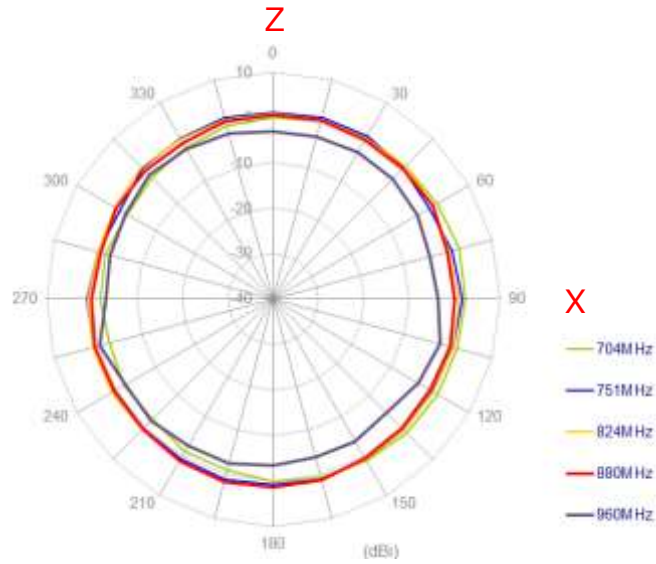

5. Drawing

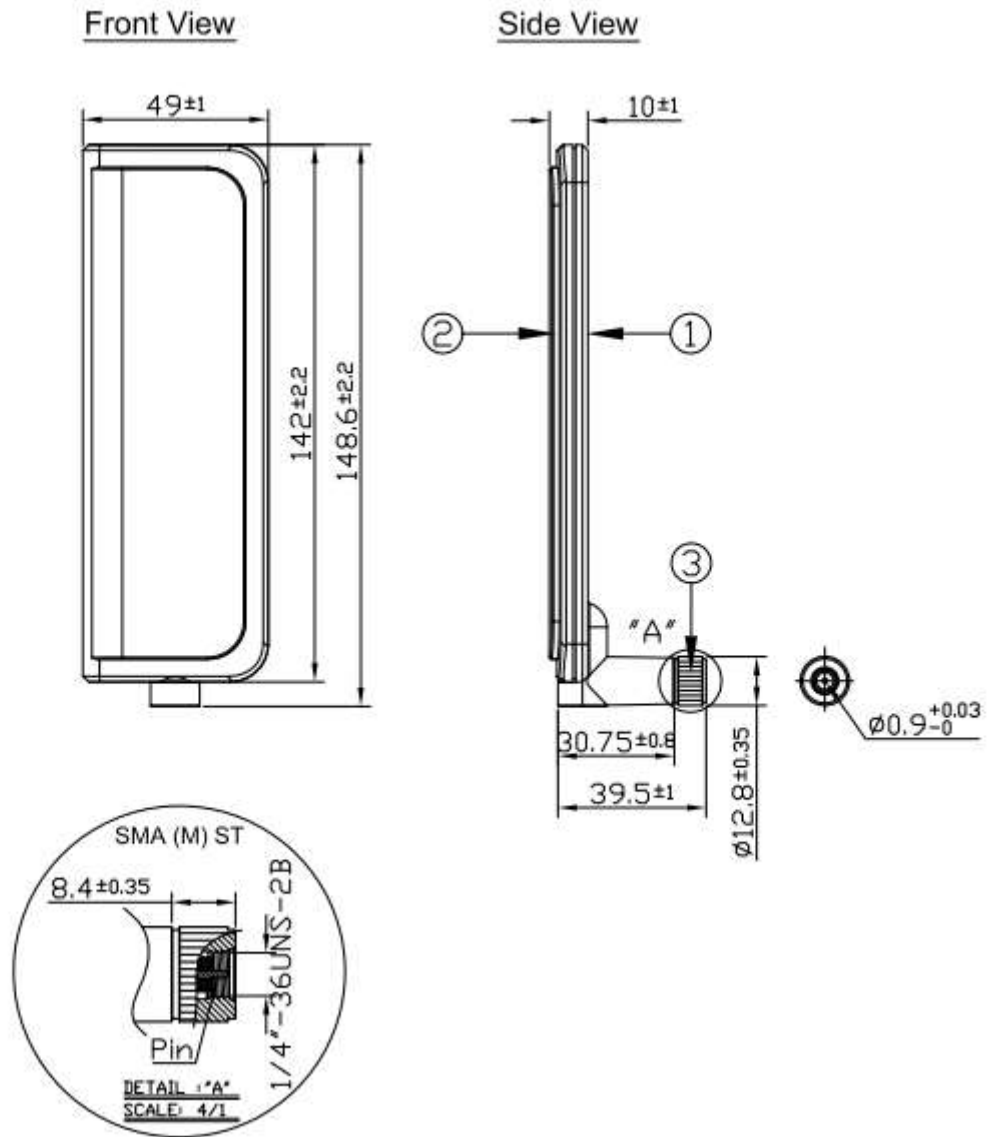

6. Packaging

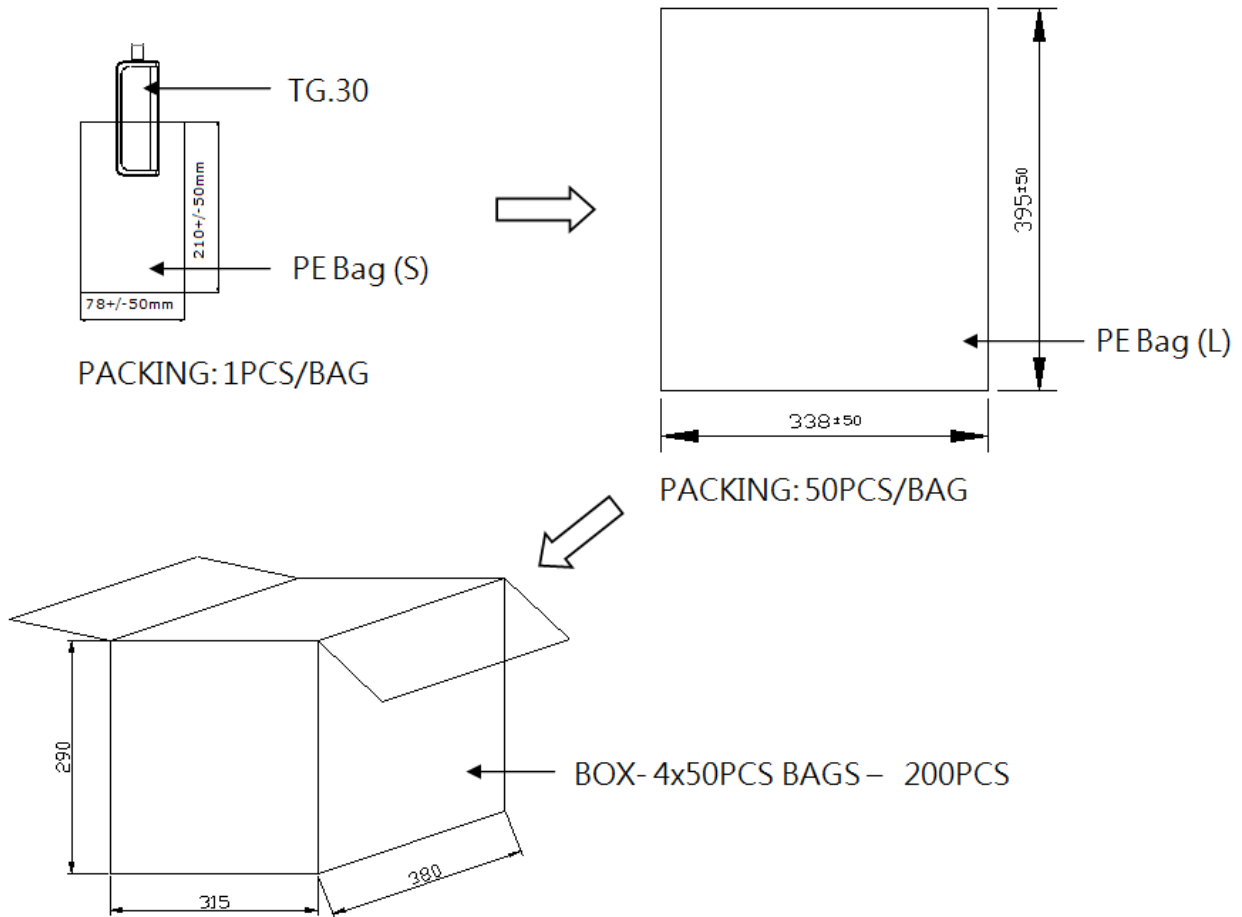

Taoglas makes no warranties based on the accuracy or completeness of the contents of this document and reserves the right to make changes to specifications and product descriptions at any time without notice. Taoglas reserves all rights to this document and the information contained herein.

Reproduction, use or disclosure to third parties without express permission is strictly prohibited.

Copyright © Taoglas Ltd.