



Is Now Part of



ON Semiconductor®

To learn more about ON Semiconductor, please visit our website at
www.onsemi.com

Please note: As part of the Fairchild Semiconductor integration, some of the Fairchild orderable part numbers will need to change in order to meet ON Semiconductor's system requirements. Since the ON Semiconductor product management systems do not have the ability to manage part nomenclature that utilizes an underscore (_), the underscore (_) in the Fairchild part numbers will be changed to a dash (-). This document may contain device numbers with an underscore (_). Please check the ON Semiconductor website to verify the updated device numbers. The most current and up-to-date ordering information can be found at www.onsemi.com. Please email any questions regarding the system integration to Fairchild_questions@onsemi.com.

ON Semiconductor and the ON Semiconductor logo are trademarks of Semiconductor Components Industries, LLC dba ON Semiconductor or its subsidiaries in the United States and/or other countries. ON Semiconductor owns the rights to a number of patents, trademarks, copyrights, trade secrets, and other intellectual property. A listing of ON Semiconductor's product/patent coverage may be accessed at www.onsemi.com/site/pdf/Patent-Marking.pdf. ON Semiconductor reserves the right to make changes without further notice to any products herein. ON Semiconductor makes no warranty, representation or guarantee regarding the suitability of its products for any particular purpose, nor does ON Semiconductor assume any liability arising out of the application or use of any product or circuit, and specifically disclaims any and all liability, including without limitation special, consequential or incidental damages. Buyer is responsible for its products and applications using ON Semiconductor products, including compliance with all laws, regulations and safety requirements or standards, regardless of any support or applications information provided by ON Semiconductor. "Typical" parameters which may be provided in ON Semiconductor data sheets and/or specifications can and do vary in different applications and actual performance may vary over time. All operating parameters, including "Typicals" must be validated for each customer application by customer's technical experts. ON Semiconductor does not convey any license under its patent rights nor the rights of others. ON Semiconductor products are not designed, intended, or authorized for use as a critical component in life support systems or any FDA Class 3 medical devices or medical devices with a same or similar classification in a foreign jurisdiction or any devices intended for implantation in the human body. Should Buyer purchase or use ON Semiconductor products for any such unintended or unauthorized application, Buyer shall indemnify and hold ON Semiconductor and its officers, employees, subsidiaries, affiliates, and distributors harmless against all claims, costs, damages, and expenses, and reasonable attorney fees arising out of, directly or indirectly, any claim of personal injury or death associated with such unintended or unauthorized use, even if such claim alleges that ON Semiconductor was negligent regarding the design or manufacture of the part. ON Semiconductor is an Equal Opportunity/Affirmative Action Employer. This literature is subject to all applicable copyright laws and is not for resale in any manner.



FDMT80040DC

N-Channel Dual Cool™ 88 PowerTrench® MOSFET

40 V, 420 A, 0.56 mΩ

Features

- Max $r_{DS(on)}$ = 0.56 mΩ at $V_{GS} = 10\text{ V}$, $I_D = 64\text{ A}$
- Max $r_{DS(on)}$ = 0.9 mΩ at $V_{GS} = 6\text{ V}$, $I_D = 47\text{ A}$
- Advanced Package and Silicon Combination for Low $r_{DS(on)}$ and High Efficiency
- Next Generation Enhanced Body Diode Technology, Engineered for Soft Recovery
- Low Profile 8x8mm MLP Package
- MSL1 Robust Package Design
- 100% UIL Tested
- RoHS Compliant



General Description

This N-Channel MOSFET is produced using Fairchild Semiconductor's advanced PowerTrench® process. Advancements in both silicon and Dual Cool™ package technologies have been combined to offer the lowest $r_{DS(on)}$ while maintaining excellent switching performance by extremely low Junction-to-Ambient thermal resistance.

Applications

- OringFET / Load Switching
- Synchronous Rectification
- DC-DC Conversion

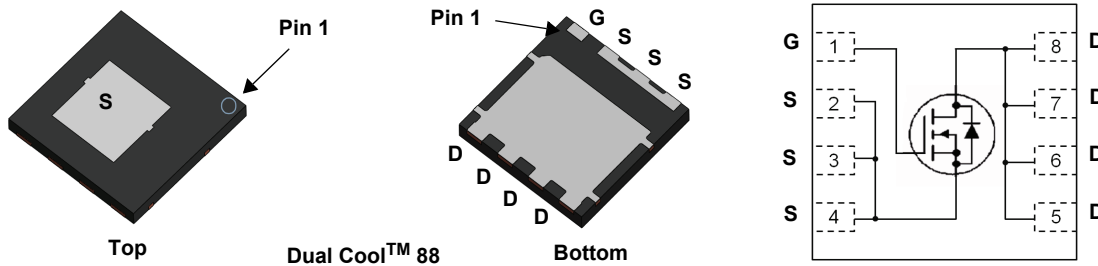

MOSFET Maximum Ratings $T_A = 25\text{ °C}$ unless otherwise noted.

| Symbol | Parameter | Rated | Units |
|----------------|---|-------------|-------|
| V_{DS} | Drain to Source Voltage | 40 | V |
| V_{GS} | Gate to Source Voltage | ±20 | V |
| I_D | Drain Current -Continuous $T_C = 25\text{ °C}$ (Note 5) | 420 | A |
| | -Continuous $T_C = 100\text{ °C}$ (Note 5) | 265 | |
| | -Continuous $T_A = 25\text{ °C}$ (Note 1a) | 64 | |
| | -Pulsed (Note 4) | 2644 | |
| E_{AS} | Single Pulse Avalanche Energy (Note 3) | 2773 | mJ |
| P_D | Power Dissipation $T_C = 25\text{ °C}$ | 156 | W |
| | Power Dissipation $T_A = 25\text{ °C}$ (Note 1a) | 3.2 | |
| T_J, T_{STG} | Operating and Storage Junction Temperature Range | -55 to +150 | °C |

Thermal Characteristics

| Symbol | Parameter | Rated | Units |
|-----------------|---|-------|-------|
| $R_{\theta JC}$ | Thermal Resistance, Junction-to-Case (Top Source) | 1.6 | °C/W |
| $R_{\theta JC}$ | Thermal Resistance, Junction-to-Case (Bottom Drain) | 0.8 | |
| $R_{\theta JA}$ | Thermal Resistance, Junction-to-Ambient (Note 1a) | 38 | |
| $R_{\theta JA}$ | Thermal Resistance, Junction-to-Ambient (Note 1b) | 81 | |
| $R_{\theta JA}$ | Thermal Resistance, Junction-to-Ambient (Note 1i) | 15 | |
| $R_{\theta JA}$ | Thermal Resistance, Junction-to-Ambient (Note 1j) | 21 | |
| $R_{\theta JA}$ | Thermal Resistance, Junction-to-Ambient (Note 1k) | 9 | |

Package Marking and Ordering Information

| Device Marking | Device | Package | Reel Size | Tape Width | Quantity |
|----------------|-------------|---------------|-----------|------------|------------|
| 80040DC | FDMT80040DC | Dual Cool™ 88 | 13" | 13.3 mm | 3000 units |

Electrical Characteristics $T_J = 25^\circ\text{C}$ unless otherwise noted.

| Symbol | Parameter | Test Conditions | Min. | Typ. | Max. | Units |
|--------|-----------|-----------------|------|------|------|-------|
|--------|-----------|-----------------|------|------|------|-------|

Off Characteristics

| | | | | | | |
|--------------------------------------|---|---|----|----|-----------|---------------|
| BV_{DSS} | Drain to Source Breakdown Voltage | $I_D = 250\ \mu\text{A}, V_{GS} = 0\ \text{V}$ | 40 | | | V |
| $\frac{\Delta BV_{DSS}}{\Delta T_J}$ | Breakdown Voltage Temperature Coefficient | $I_D = 250\ \mu\text{A}$, referenced to 25°C | | 21 | | mV/°C |
| I_{DSS} | Zero Gate Voltage Drain Current | $V_{DS} = 32\ \text{V}, V_{GS} = 0\ \text{V}$ | | | 10 | μA |
| I_{GSS} | Gate to Source Leakage Current | $V_{GS} = \pm 20\ \text{V}, V_{DS} = 0\ \text{V}$ | | | ± 100 | nA |

On Characteristics

| | | | | | | |
|--|--|--|-----|------|------|------------|
| $V_{GS(th)}$ | Gate to Source Threshold Voltage | $V_{GS} = V_{DS}, I_D = 250\ \mu\text{A}$ | 2.0 | 2.7 | 4.0 | V |
| $\frac{\Delta V_{GS(th)}}{\Delta T_J}$ | Gate to Source Threshold Voltage Temperature Coefficient | $I_D = 250\ \mu\text{A}$, referenced to 25°C | | -9 | | mV/°C |
| $r_{DS(on)}$ | Static Drain to Source On Resistance | $V_{GS} = 10\ \text{V}, I_D = 64\ \text{A}$ | | 0.44 | 0.56 | m Ω |
| | | $V_{GS} = 6\ \text{V}, I_D = 47\ \text{A}$ | | 0.63 | 0.9 | |
| | | $V_{GS} = 10\ \text{V}, I_D = 64\ \text{A}, T_J = 125^\circ\text{C}$ | | 0.66 | 0.84 | |
| g_{FS} | Forward Transconductance | $V_{DS} = 5\ \text{V}, I_D = 64\ \text{A}$ | | 278 | | S |

Dynamic Characteristics

| | | | | | | |
|-----------|------------------------------|---|-----|-------|-------|----------|
| C_{iss} | Input Capacitance | $V_{DS} = 20\ \text{V}, V_{GS} = 0\ \text{V},$ $f = 1\ \text{MHz}$ | | 18650 | 26110 | pF |
| C_{oss} | Output Capacitance | | | 5540 | 7760 | pF |
| C_{rss} | Reverse Transfer Capacitance | | | 304 | 1210 | pF |
| R_g | Gate Resistance | | 0.1 | 1.8 | 3.6 | Ω |

Switching Characteristics

| | | | | | | | |
|--------------|-------------------------------|--|---|--|-----|-----|----|
| $t_{d(on)}$ | Turn-On Delay Time | $V_{DD} = 20\ \text{V}, I_D = 64\ \text{A},$ $V_{GS} = 10\ \text{V}, R_{GEN} = 6\ \Omega$ | | 63 | 101 | ns | |
| t_r | Rise Time | | | 62 | 100 | ns | |
| $t_{d(off)}$ | Turn-Off Delay Time | | | 101 | 162 | ns | |
| t_f | Fall Time | | | 43 | 69 | ns | |
| $Q_{g(TOT)}$ | Total Gate Charge | | $V_{GS} = 0\ \text{V to } 10\ \text{V}$ | | 241 | 338 | nC |
| $Q_{g(TOT)}$ | Total Gate Charge | | $V_{GS} = 0\ \text{V to } 6\ \text{V}$ | $V_{DD} = 20\ \text{V},$ $I_D = 64\ \text{A}$ | 149 | 209 | nC |
| Q_{gs} | Gate to Source Charge | | | 76 | | nC | |
| Q_{gd} | Gate to Drain "Miller" Charge | | | 35 | | nC | |

Drain-Source Diode Characteristics

| | | | | | | |
|----------|---------------------------------------|---|--|------|-----|----|
| V_{SD} | Source to Drain Diode Forward Voltage | $V_{GS} = 0\ \text{V}, I_S = 2.6\ \text{A}$ (Note 2) | | 0.67 | 1.1 | V |
| | | $V_{GS} = 0\ \text{V}, I_S = 64\ \text{A}$ (Note 2) | | 0.77 | 1.2 | |
| t_{rr} | Reverse Recovery Time | $I_F = 64\ \text{A}, di/dt = 100\ \text{A}/\mu\text{s}$ | | 94 | 151 | ns |
| Q_{rr} | Reverse Recovery Charge | | | 219 | 351 | nC |

Thermal Characteristics

| | | | | |
|-----------------|---|----------------|-----|-----------------------------|
| $R_{\theta JC}$ | Thermal Resistance, Junction-to-Case | (Top Source) | 1.6 | $^{\circ}\text{C}/\text{W}$ |
| $R_{\theta JC}$ | Thermal Resistance, Junction-to-Case | (Bottom Drain) | 0.8 | |
| $R_{\theta JA}$ | Thermal Resistance, Junction-to-Ambient | (Note 1a) | 38 | |
| $R_{\theta JA}$ | Thermal Resistance, Junction-to-Ambient | (Note 1b) | 81 | |
| $R_{\theta JA}$ | Thermal Resistance, Junction-to-Ambient | (Note 1c) | 26 | |
| $R_{\theta JA}$ | Thermal Resistance, Junction-to-Ambient | (Note 1d) | 34 | |
| $R_{\theta JA}$ | Thermal Resistance, Junction-to-Ambient | (Note 1e) | 14 | |
| $R_{\theta JA}$ | Thermal Resistance, Junction-to-Ambient | (Note 1f) | 16 | |
| $R_{\theta JA}$ | Thermal Resistance, Junction-to-Ambient | (Note 1g) | 26 | |
| $R_{\theta JA}$ | Thermal Resistance, Junction-to-Ambient | (Note 1h) | 60 | |
| $R_{\theta JA}$ | Thermal Resistance, Junction-to-Ambient | (Note 1i) | 15 | |
| $R_{\theta JA}$ | Thermal Resistance, Junction-to-Ambient | (Note 1j) | 21 | |
| $R_{\theta JA}$ | Thermal Resistance, Junction-to-Ambient | (Note 1k) | 9 | |
| $R_{\theta JA}$ | Thermal Resistance, Junction-to-Ambient | (Note 1l) | 11 | |

NOTES:

1. $R_{\theta JA}$ is determined with the device mounted on a FR-4 board using a specified pad of 2 oz copper as shown below. $R_{\theta CA}$ is determined by the user's board design.

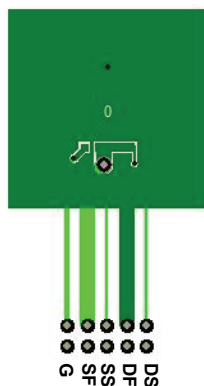

a. 38 $^{\circ}\text{C}/\text{W}$ when mounted on a 1 in² pad of 2 oz copper



b. 81 $^{\circ}\text{C}/\text{W}$ when mounted on a minimum pad of 2 oz copper

- c. Still air, 20.9x10.4x12.7mm Aluminum Heat Sink, 1 in² pad of 2 oz copper
- d. Still air, 20.9x10.4x12.7mm Aluminum Heat Sink, minimum pad of 2 oz copper
- e. Still air, 45.2x41.4x11.7mm Aavid Thermalloy Part # 10-L41B-11 Heat Sink, 1 in² pad of 2 oz copper
- f. Still air, 45.2x41.4x11.7mm Aavid Thermalloy Part # 10-L41B-11 Heat Sink, minimum pad of 2 oz copper
- g. 200FPM Airflow, No Heat Sink, 1 in² pad of 2 oz copper
- h. 200FPM Airflow, No Heat Sink, minimum pad of 2 oz copper
- i. 200FPM Airflow, 20.9x10.4x12.7mm Aluminum Heat Sink, 1 in² pad of 2 oz copper
- j. 200FPM Airflow, 20.9x10.4x12.7mm Aluminum Heat Sink, minimum pad of 2 oz copper
- k. 200FPM Airflow, 45.2x41.4x11.7mm Aavid Thermalloy Part # 10-L41B-11 Heat Sink, 1 in² pad of 2 oz copper
- l. 200FPM Airflow, 45.2x41.4x11.7mm Aavid Thermalloy Part # 10-L41B-11 Heat Sink, minimum pad of 2 oz copper

2. Pulse Test: Pulse Width < 300 μs , Duty cycle < 2.0%.

3. E_{AS} of 2773mJ is based on starting $T_J = 25^{\circ}\text{C}$; N-ch: L = 3 mH, $I_{AS} = 43\text{ A}$, $V_{DD} = 40\text{ V}$, $V_{GS} = 10\text{ V}$. 100% test at L = 0.3 mH, $I_{AS} = 93\text{ A}$.

4. Pulsed Id please refer to Fig 11 SOA graph for more details.

5. Computed continuous current limited to Max Junction Temperature only, actual continuous current will be limited by thermal & electro-mechanical application board design.

Typical Characteristics $T_J = 25\text{ }^\circ\text{C}$ unless otherwise noted.

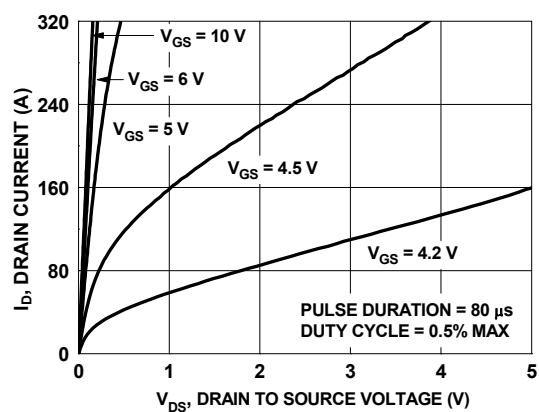

Figure 1. On Region Characteristics

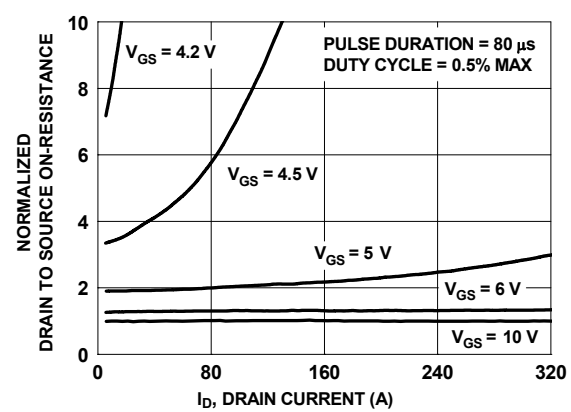

Figure 2. Normalized On-Resistance vs. Drain Current and Gate Voltage

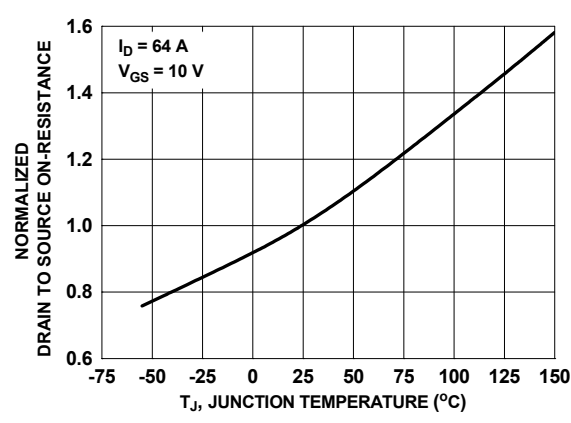

Figure 3. Normalized On Resistance vs. Junction Temperature

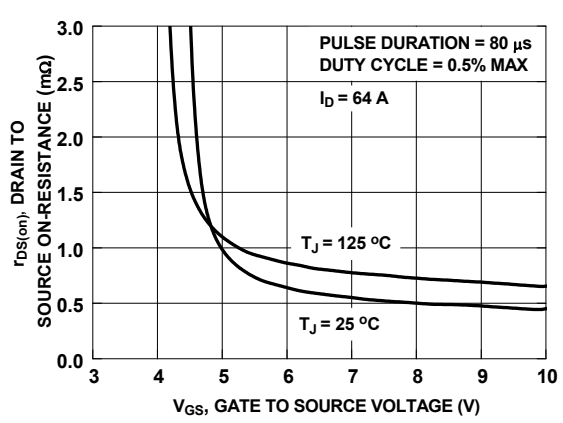

Figure 4. On-Resistance vs. Gate to Source Voltage

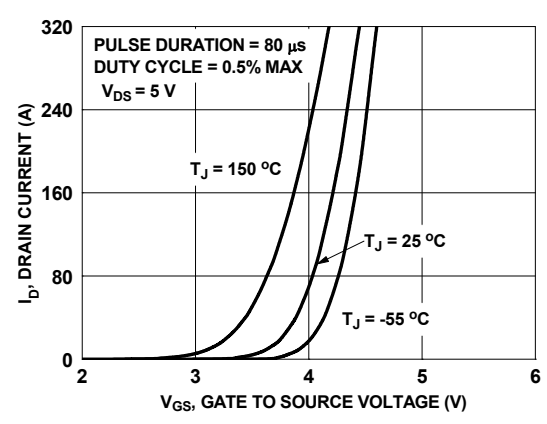

Figure 5. Transfer Characteristics

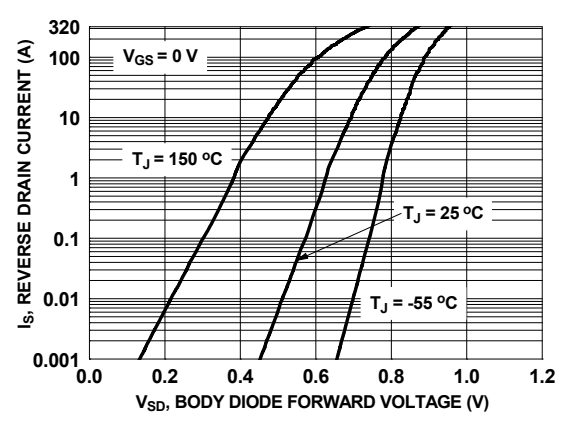

Figure 6. Source to Drain Diode Forward Voltage vs. Source Current

Typical Characteristics $T_J = 25^\circ\text{C}$ unless otherwise noted.

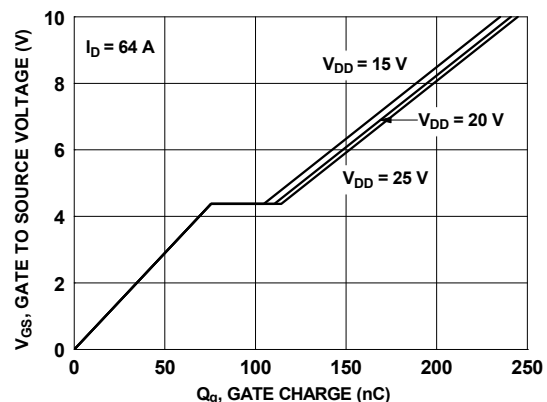

Figure 7. Gate Charge Characteristics

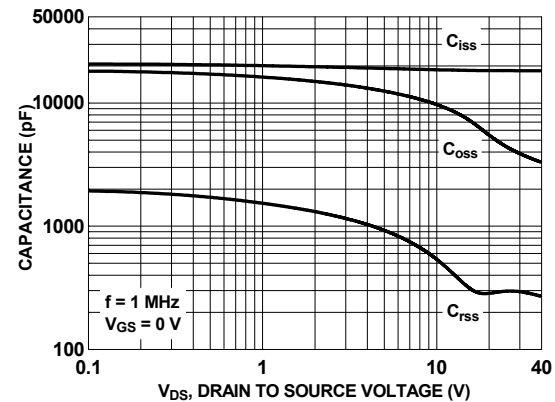

Figure 8. Capacitance vs Drain to Source Voltage

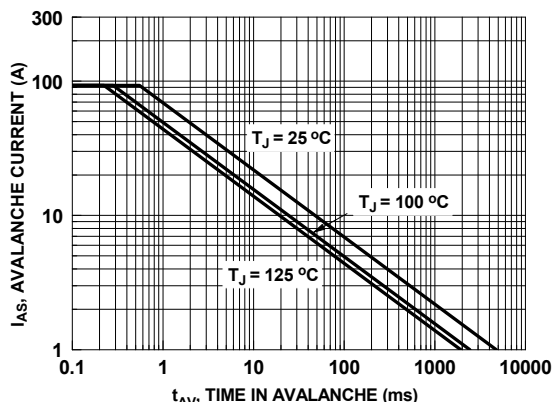

Figure 9. Unclamped Inductive Switching Capability

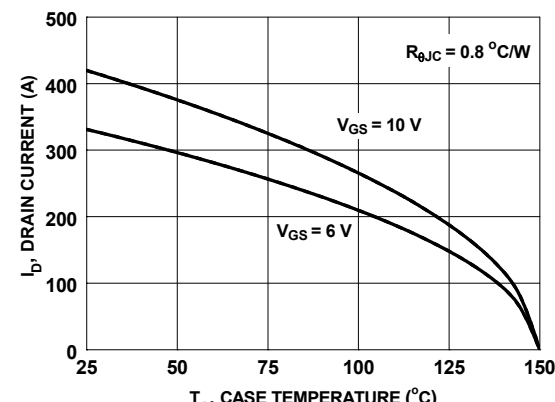

Figure 10. Maximum Continuous Drain Current vs. Case Temperature

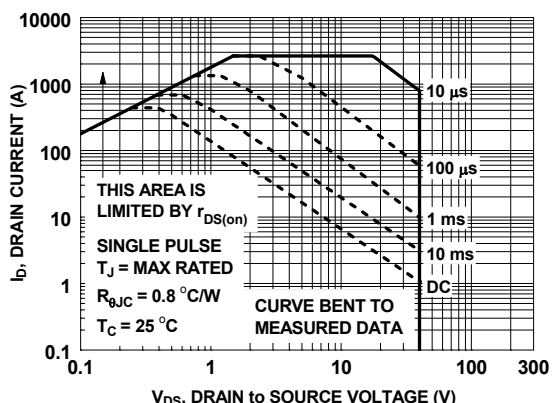

Figure 11. Forward Bias Safe Operating Area

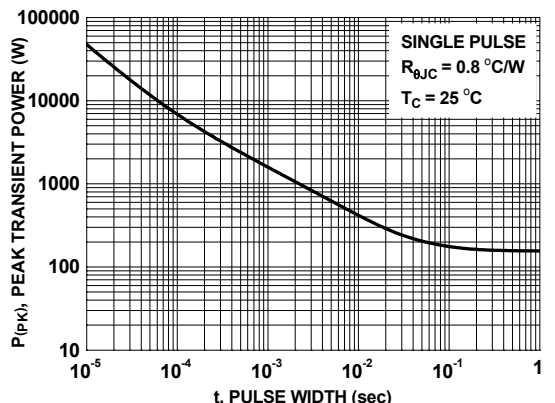

Figure 12. Single Pulse Maximum Power Dissipation

Typical Characteristics $T_J = 25\text{ }^\circ\text{C}$ unless otherwise noted.

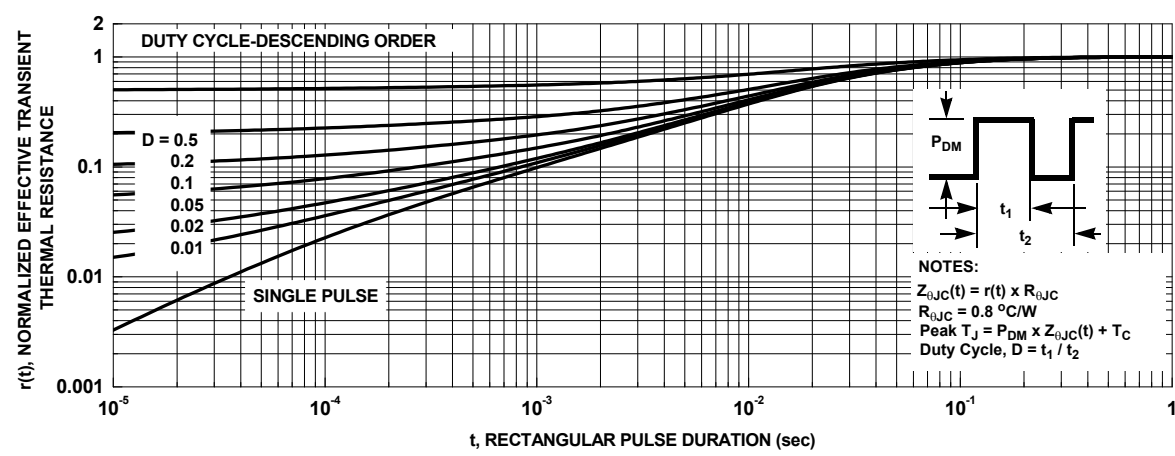
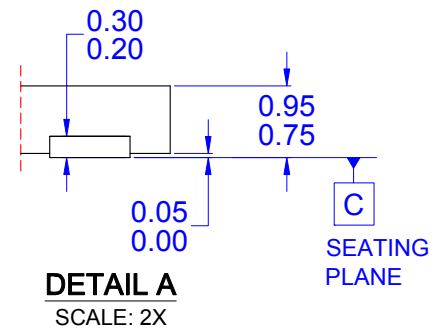
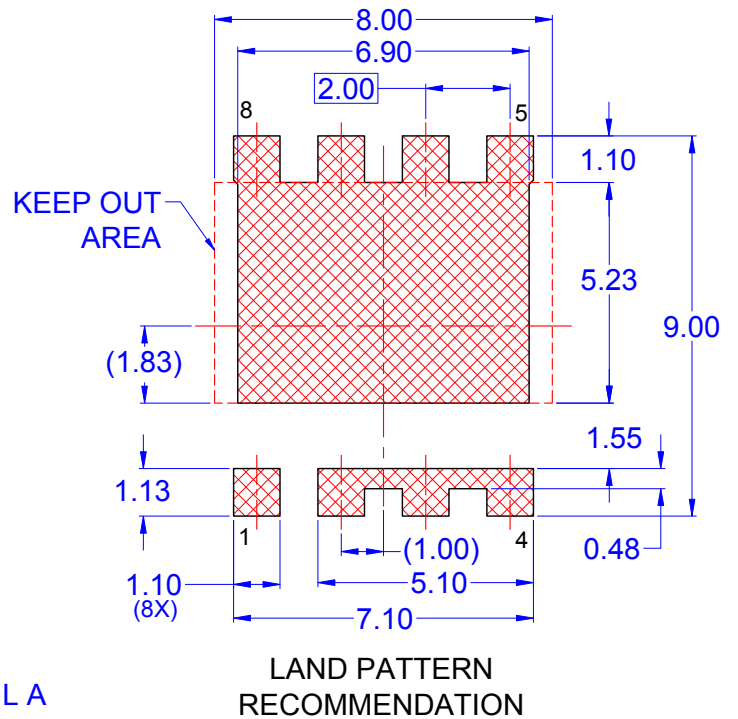
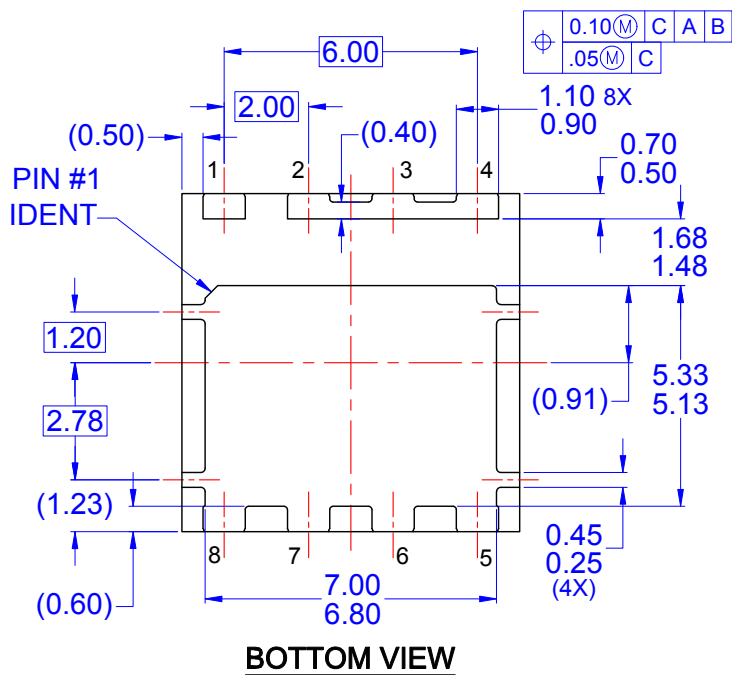
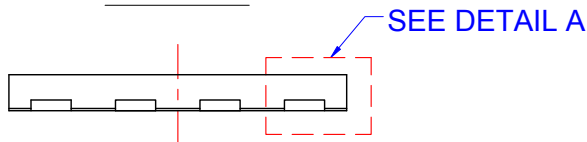
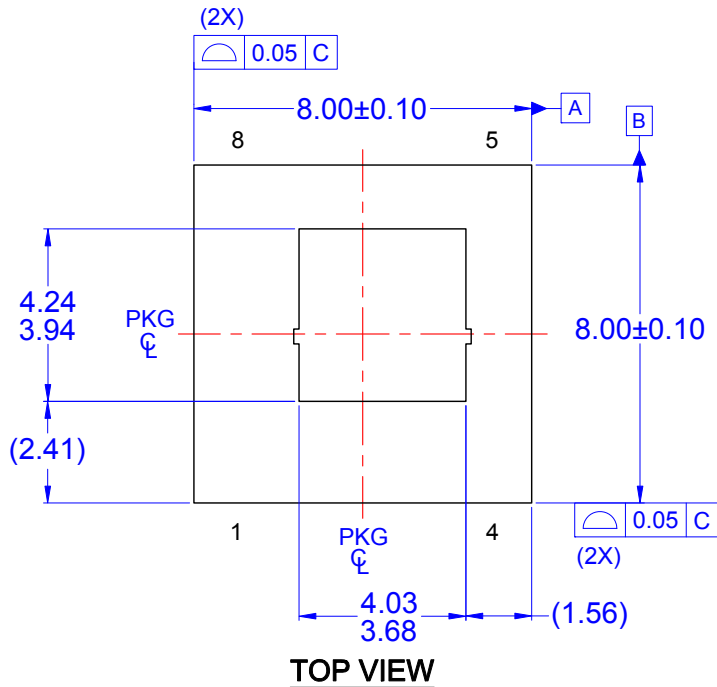

Figure 13. Junction-to-Case Transient Thermal Response Curve



- NOTES: UNLESS OTHERWISE SPECIFIED
- A) THIS PACKAGE IS NOT PRESENTLY REGISTERED WITH ANY STANDARDS COMMITTEE.
 - B) DIMENSIONS ARE INCLUSIVE OF BURRS, MOLD FLASH, AND TIE BAR PROTRUSIONS.
 - C) ALL DIMENSIONS ARE IN MILLIMETERS.
 - D) DRAWING CONFORMS TO ASME Y14.5M-2009.
 - E) IT IS RECOMMENDED TO HAVE NO TRACES OR VIAS WITHIN THE KEEP OUR AREA.
 - F) DRAWING FILENAME: MKT-PQFN08RREV2



ON Semiconductor and  are trademarks of Semiconductor Components Industries, LLC dba ON Semiconductor or its subsidiaries in the United States and/or other countries. ON Semiconductor owns the rights to a number of patents, trademarks, copyrights, trade secrets, and other intellectual property. A listing of ON Semiconductor's product/patent coverage may be accessed at www.onsemi.com/site/pdf/Patent-Marking.pdf. ON Semiconductor reserves the right to make changes without further notice to any products herein. ON Semiconductor makes no warranty, representation or guarantee regarding the suitability of its products for any particular purpose, nor does ON Semiconductor assume any liability arising out of the application or use of any product or circuit, and specifically disclaims any and all liability, including without limitation special, consequential or incidental damages. Buyer is responsible for its products and applications using ON Semiconductor products, including compliance with all laws, regulations and safety requirements or standards, regardless of any support or applications information provided by ON Semiconductor. "Typical" parameters which may be provided in ON Semiconductor data sheets and/or specifications can and do vary in different applications and actual performance may vary over time. All operating parameters, including "Typicals" must be validated for each customer application by customer's technical experts. ON Semiconductor does not convey any license under its patent rights nor the rights of others. ON Semiconductor products are not designed, intended, or authorized for use as a critical component in life support systems or any FDA Class 3 medical devices or medical devices with a same or similar classification in a foreign jurisdiction or any devices intended for implantation in the human body. Should Buyer purchase or use ON Semiconductor products for any such unintended or unauthorized application, Buyer shall indemnify and hold ON Semiconductor and its officers, employees, subsidiaries, affiliates, and distributors harmless against all claims, costs, damages, and expenses, and reasonable attorney fees arising out of, directly or indirectly, any claim of personal injury or death associated with such unintended or unauthorized use, even if such claim alleges that ON Semiconductor was negligent regarding the design or manufacture of the part. ON Semiconductor is an Equal Opportunity/Affirmative Action Employer. This literature is subject to all applicable copyright laws and is not for resale in any manner.

PUBLICATION ORDERING INFORMATION

LITERATURE FULFILLMENT:

Literature Distribution Center for ON Semiconductor
19521 E. 32nd Pkwy, Aurora, Colorado 80011 USA
Phone: 303-675-2175 or 800-344-3860 Toll Free USA/Canada
Fax: 303-675-2176 or 800-344-3867 Toll Free USA/Canada
Email: orderlit@onsemi.com

N. American Technical Support: 800-282-9855 Toll Free
USA/Canada
Europe, Middle East and Africa Technical Support:
Phone: 421 33 790 2910
Japan Customer Focus Center
Phone: 81-3-5817-1050

ON Semiconductor Website: www.onsemi.com
Order Literature: <http://www.onsemi.com/orderlit>
For additional information, please contact your local
Sales Representative

Mouser Electronics

Authorized Distributor

Click to View Pricing, Inventory, Delivery & Lifecycle Information:

[onsemi:](#)

[FDMT80040DC](#)