

High Performance Switched Capacitor Universal Filter

FEATURES

- All Filter Parameters *Guaranteed* Over Temperature
- Wide Center Frequency Range (0.1Hz to 40kHz)
- Low Noise, Wide Dynamic Range
- *Guaranteed* Operation for $\pm 2.37V$ and $\pm 5V$ Supply
- Low Power Consumption
- *Guaranteed* Clock-to-Center Frequency Accuracy of 0.8%
- *Guaranteed* Low Offset Voltages Over Temperature
- Very Low Center Frequency and Q Tempco
- Clock Input T²L or CMOS Compatible
- Separate Highpass (or Notch or Allpass), Bandpass, Lowpass Outputs

APPLICATIONS

- Sinewave Oscillators
- Sweepable Bandpass/Notch Filters
- Full Audio Frequency Filters
- Tracking Filters

 LTC and LT are registered trademarks of Linear Technology Corporation.
LTCMOS trademark of Linear Technology Corporation.

DESCRIPTION

The LTC[®]1059 consists of a general purpose, high performance, active filter building block and an uncommitted op amp. The filter building block together with an external clock and 2 to 5 resistors can produce various 2nd order functions which are available at its three output pins. Two out of three always provide lowpass and bandpass functions while the third output pin can produce notch or highpass or allpass. The center frequency of these functions can be tuned from 0.1Hz to 40kHz and is dependent on an external clock or an external clock and a resistor ratio. The filter can handle input frequencies up to 100kHz. The uncommitted op amp can be used to obtain additional allpass and notch functions, for gain adjustment or for cascading techniques.

Higher than 2nd order filter functions can be obtained by cascading the LTC1059 with the LTC1060 dual universal filter or the LTC1061 triple universal filter. Any classical filter realization (such as Butterworth, Cauer, Bessel and Chebyshev) can be formed.

The LTC1059 can be operated with single or dual supplies ranging from $\pm 2.37V$ to $\pm 8V$ (or 4.74V to 16V single supply).

The LTC1059 is manufactured by using Linear Technology's enhanced LTCMOS[™] silicon gate process.

TYPICAL APPLICATION

Wide Range 2nd Order Bandpass/Notch Filter with Q = 10

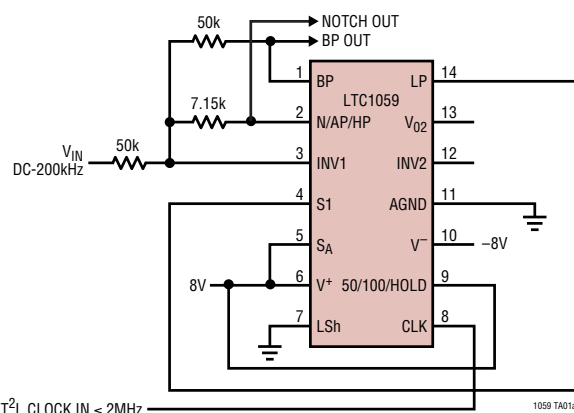

Center Frequency and Q Error

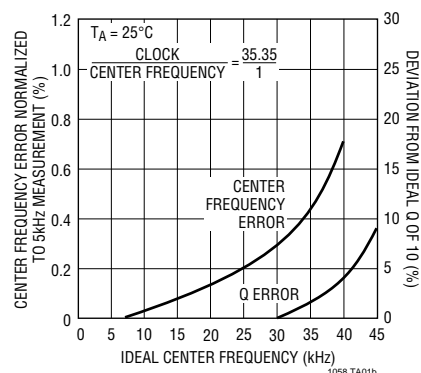

ABSOLUTE MAXIMUM RATINGS

(Note 1)

Supply Voltage	18V
Power Dissipation	500mW
Operating Temperature Range	
LTC1059C	$-40^{\circ}\text{C} \leq T_A \leq 85^{\circ}\text{C}$
LTC1059AM, LTC1059M	$-55^{\circ}\text{C} \leq T_A \leq 125^{\circ}\text{C}$
Storage Temperature Range	-65°C to 150°C
Lead Temperature (Soldering, 10 sec).....	300°C

PACKAGE/ORDER INFORMATION

<p>TOP VIEW</p> <p>N PACKAGE 14-LEAD PDIP</p> <p>S PACKAGE 14-LEAD PLASTIC SO</p> <p>$T_{JMAX} = 110^{\circ}\text{C}$, $\theta_{JA} = 130^{\circ}\text{C/W}$ (N) $T_{JMAX} = 110^{\circ}\text{C}$, $\theta_{JA} = 110^{\circ}\text{C/W}$ (S)</p> <p>J PACKAGE 14-LEAD CERDIP</p> <p>$T_{JMAX} = 150^{\circ}\text{C}$, $\theta_{JA} = 80^{\circ}\text{C/W}$</p> <p>OBSOLETE PACKAGE Consider the N or S Package for Alternate Source</p>	ORDER PART NUMBER
	<p>LTC1059CN LTC1059CS</p> <p>LTC1059ACJ LTC1059AMJ LTC1059CJ LTC1059MJ</p>

Consult LTC Marketing for parts specified with wider operating temperature ranges.

ELECTRICAL CHARACTERISTICS

The ● denotes the specifications which apply over the full operating temperature range, otherwise specifications are at $T_A = 25^{\circ}\text{C}$.

(Complete Filter) $V_S = \pm 5\text{V}$, T^2L clock input level unless otherwise specified.

PARAMETER	CONDITIONS	MIN	TYP	MAX	UNITS
Center Frequency Range, f_0	$f_0 \bullet Q \leq 400\text{kHz}$, Mode 1 $f_0 \bullet Q \leq 1.6\text{MHz}$, Mode 1 $f_0 \bullet Q \leq 250\text{kHz}$, Mode 3, $V_S = \pm 7.5\text{V}$ $f_0 \bullet Q \leq 1\text{MHz}$, Mode 3, $V_S = \pm 7.5\text{V}$		0.1 - 40k 0.1 - 18k 0.1 - 20k 0.1 - 16k		Hz Hz Hz Hz
Input Frequency Range			0 - 200k		Hz
Clock-to-Center Frequency Ratio	Mode 1, 50:1, $f_{CLK} = 250\text{kHz}$, $Q = 10$ Mode 1, 100:1, $f_{CLK} = 500\text{kHz}$, $Q = 10$	●		$50 \pm 0.8\%$ $100 \pm 0.8\%$	
Q Accuracy	Mode 1, 50:1 or 100:1, $f_0 = 5\text{kHz}$ $Q = 10$	●	± 0.5	5	%
f_0 Temperature Coefficient	Mode 1, $f_{CLK} < 500\text{kHz}$		5		ppm/°C
Q Temperature Coefficient	Mode 1, $f_{CLK} < 500\text{kHz}$, $Q = 10$		15		ppm/°C
DC Offset	V_{OS1} V_{OS2} V_{OS2} V_{OS2} V_{OS2} V_{OS2} V_{OS2} V_{OS2} V_{OS2} V_{OS2} V_{OS3} V_{OS3} V_{OS3} V_{OS3}	●	2 3 3 6 6 2 2 4 4 2 2 4 4	15 30 40 60 80 20 30 40 60 20 30 40 60	mV mV mV mV mV mV mV mV mV mV mV mV mV mV
	$f_{CLK} = 250\text{kHz}$, 50:1, S_A High (N Package) $f_{CLK} = 250\text{kHz}$, 50:1, S_A High (S Package) $f_{CLK} = 500\text{kHz}$, 100:1, S_A High (N Package) $f_{CLK} = 500\text{kHz}$, 100:1, S_A High (S Package) $f_{CLK} = 250\text{kHz}$, 50:1, S_A Low (N Package) $f_{CLK} = 250\text{kHz}$, 50:1, S_A Low (S Package) $f_{CLK} = 500\text{kHz}$, 100:1, S_A Low (N Package) $f_{CLK} = 500\text{kHz}$, 100:1, S_A Low (S Package) $f_{CLK} = 250\text{kHz}$, 50:1 (N Package) $f_{CLK} = 250\text{kHz}$, 50:1 (S Package) $f_{CLK} = 500\text{kHz}$, 100:1 (N Package) $f_{CLK} = 500\text{kHz}$, 100:1 (S Package)	●	4 4	60	mV mV

ELECTRICAL CHARACTERISTICS

The ● denotes the specifications which apply over the full operating temperature range, otherwise specifications are at $T_A = 25^\circ\text{C}$.

(Complete Filter) $V_S = \pm 5\text{V}$, $T^2\text{L}$ Clock Input Level unless otherwise specified.

PARAMETER	CONDITIONS	MIN	TYP	MAX	UNITS
DC Lowpass Gain Accuracy	Mode 1, $R_1 = R_2 = 50\text{k}\Omega$	●	± 0.1	2	%
BP Gain Accuracy at f_0	Mode 1, $Q = 10$, $f_0 = 5\text{kHz}$		± 0.1		%
Clock Feedthrough	$f_{\text{CLK}} \leq 1\text{MHz}$		10		mV
Max Clock Frequency	Mode 1, $Q < 5$, $V_S \geq \pm 5\text{V}$		2		MHz
Power Supply Current		●	3.5	5.5 7	mA mA

(Complete Filter) $V_S = \pm 2.37\text{V}$ unless otherwise specified.

PARAMETER	CONDITIONS	MIN	TYP	MAX	UNITS
Center Frequency Range	$f_0 \cdot Q \leq 120\text{kHz}$, Mode 1, 50:1		0.1 - 12k		Hz
	$f_0 \cdot Q \leq 120\text{kHz}$, Mode 3, 50:1		0.1 - 10k		Hz
Input Frequency Range			60k		Hz
Clock-to-Center Frequency Ratio	Mode 1, 50:1, $f_{\text{CLK}} = 250\text{kHz}$, $Q = 10$ Mode 1, 100:1, $f_{\text{CLK}} = 250\text{kHz}$, $Q = 10$		$50 \pm 0.8\%$ $100 \pm 0.8\%$		
Q Accuracy	Mode 1, $f_{\text{CLK}} = 250\text{kHz}$, $Q = 10$ 50:1 and 100:1		± 2		%
Max Clock Frequency			700		kHz
Power Supply Current			1.5	2.5	mA

(Internal Op Amps) The ● denotes the specifications which apply over the full operating temperature range, otherwise specifications are at $T_A = 25^\circ\text{C}$.

PARAMETER	CONDITIONS	MIN	TYP	MAX	UNITS
Supply Voltage Range		± 2.375		± 8	V
Voltage Swings	$V_S = \pm 5\text{V}$, $R_L = 5\text{k}$ (Pins 1, 14) $R_L = 3.5\text{k}$ (Pins 2, 13)	●	± 3.8 ± 3.6	± 4.2	V V
Input Offset Voltage		●	1	15	mV
Input Bias Current			3		pA
Output Short-Circuit Current Source/Sink	$V_S = \pm 5\text{V}$ (N Package) $V_S = \pm 5\text{V}$ (S Package)		40/3 25/3		mA mA
DC Open Loop Gain	$V_S = \pm 5\text{V}$		80		dB
GBW	$V_S = \pm 5\text{V}$		2		MHz
Slew Rate	$V_S = \pm 5\text{V}$		7		V/ μs

Note 1: Absolute Maximum Ratings are those values beyond which the life of a device may be impaired.

TYPICAL PERFORMANCE CHARACTERISTICS

**Graph 1. Mode 1:
(f_{CLK}/f_0) Deviation vs Q**

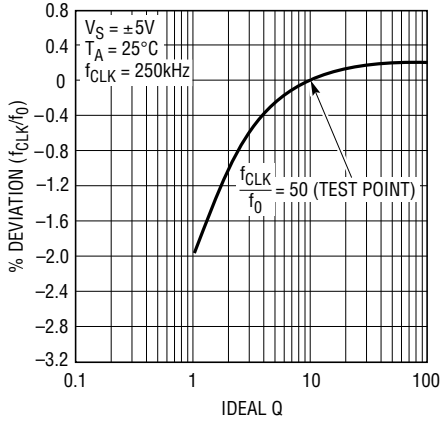

**Graph 2. Mode 1:
(f_{CLK}/f_0) Deviation vs Q**

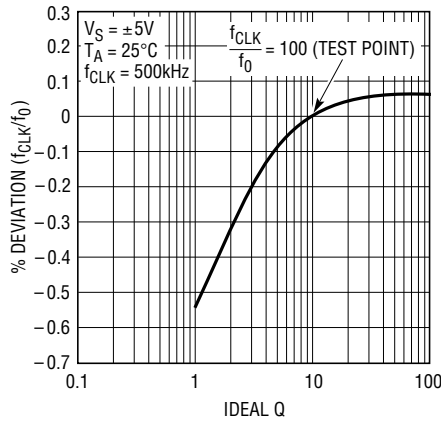

**Graph 3. Mode 1: Q Error
vs Clock Frequency**

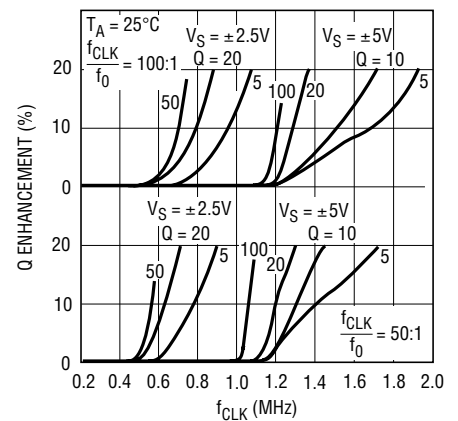

**Graph 4. Mode 1: Q Error
vs Clock Frequency**

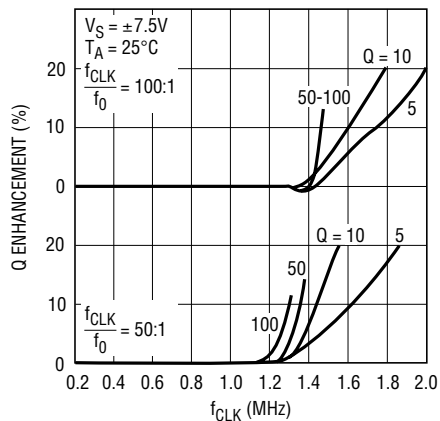

**Graph 5. Mode 1: Measured Q
vs f_{CLK} and Temperature**

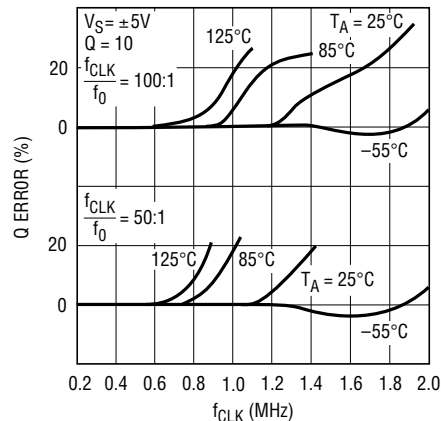

**Graph 6. Mode 1: (f_{CLK}/f_0)
vs f_{CLK} and Q**

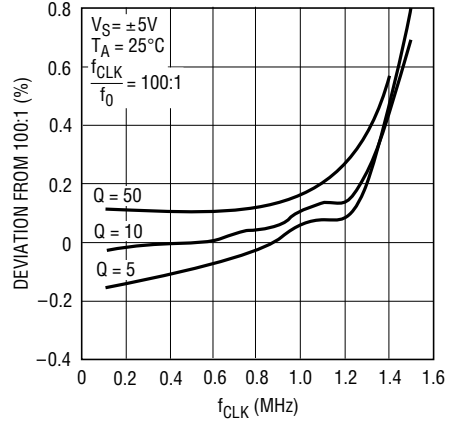

**Graph 7. Mode 1: (f_{CLK}/f_0)
vs f_{CLK} and Q**

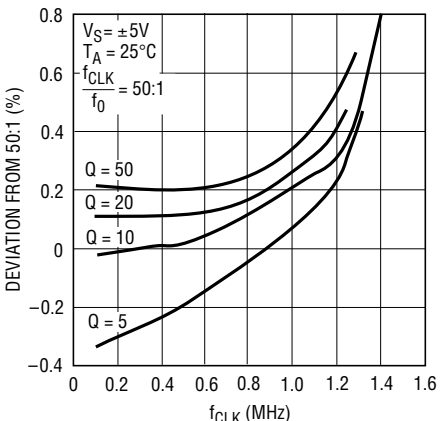

**Graph 8. Mode 1: (f_{CLK}/f_0)
vs f_{CLK} and Temperature**

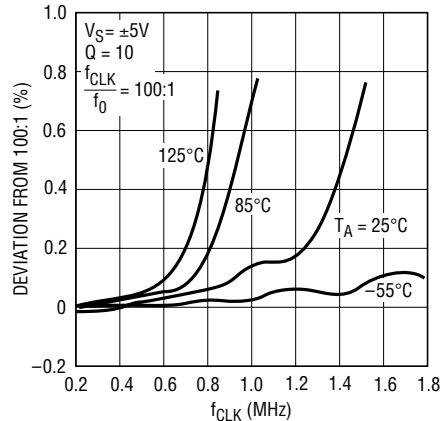

**Graph 9. Mode 1: (f_{CLK}/f_0)
vs f_{CLK} and Temperature**

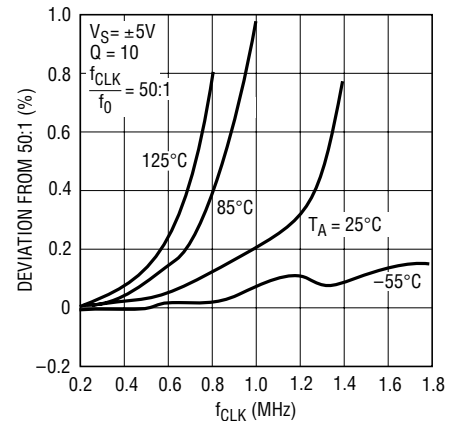

TYPICAL PERFORMANCE CHARACTERISTICS

Graph 10. Mode 1: (f_{CLK}/f_0) vs f_{CLK} and Q

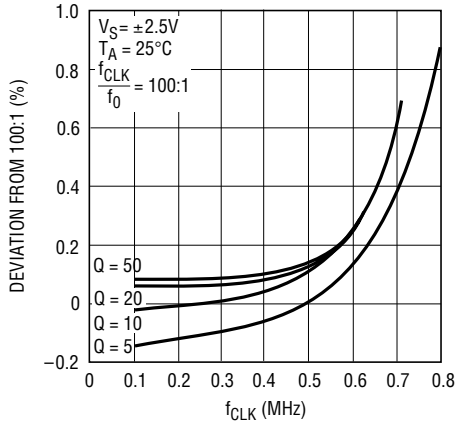

1059 G10

Graph 11. Mode 1: (f_{CLK}/f_0) vs f_{CLK} and Q

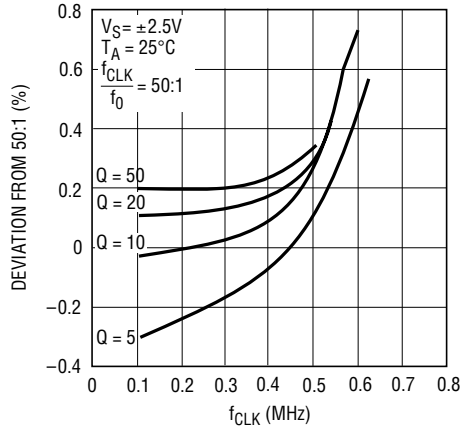

1059 G11

Graph 12. Mode 1: (f_{CLK}/f_0) vs f_{CLK} and Temperature

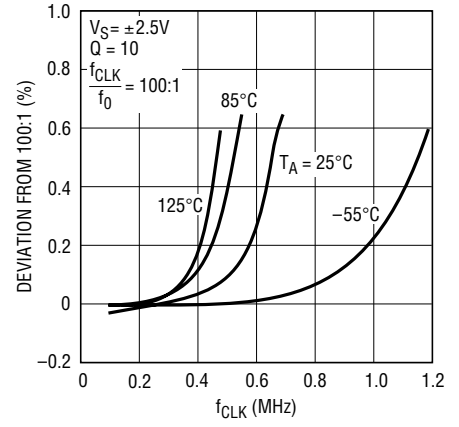

1059 • G12

Graph 13. Mode 1: (f_{CLK}/f_0) vs f_{CLK} and Temperature

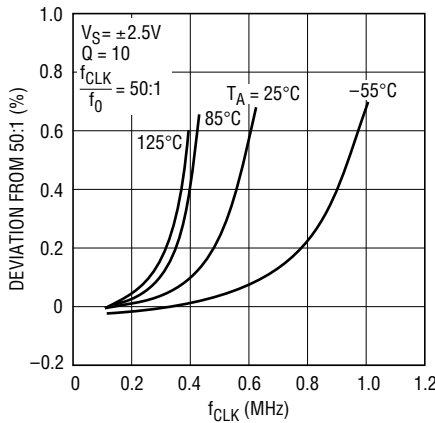

1059 G13

Graph 14. Mode 1: Notch Depth vs Clock Frequency

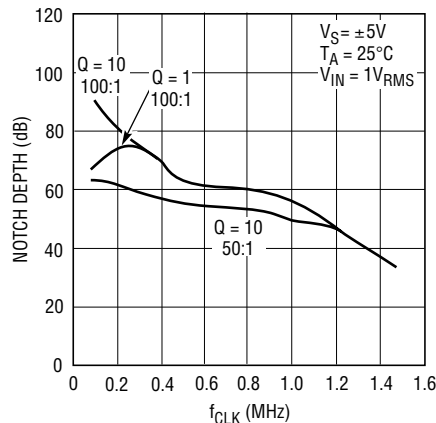

1059 G14

Graph 15. Mode 3: Deviation of (f_{CLK}/f_0) with Respect to Q = 10 Measurement

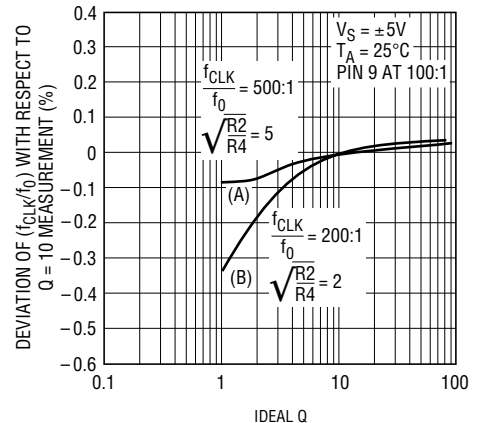

1059 G15

Graph 16. Mode 3: Q Error vs Clock Frequency

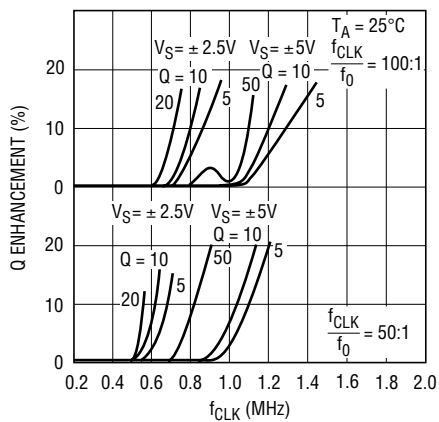

1059 G16

Graph 17. Mode 3 (R2 = R4): Q Error vs Clock Frequency

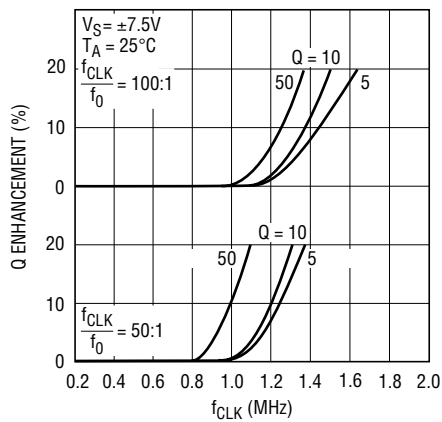

1059 G17

Graph 18. Mode 3 (R2 = R4): Measured Q vs f_{CLK} and Temperature

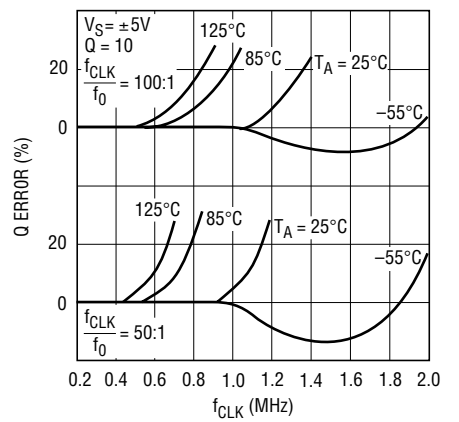

1059 G18

1059fd

TYPICAL PERFORMANCE CHARACTERISTICS

**Graph 19. Mode 3 (R2 = R4):
(f_{CLK}/f₀) vs f_{CLK} and Q**

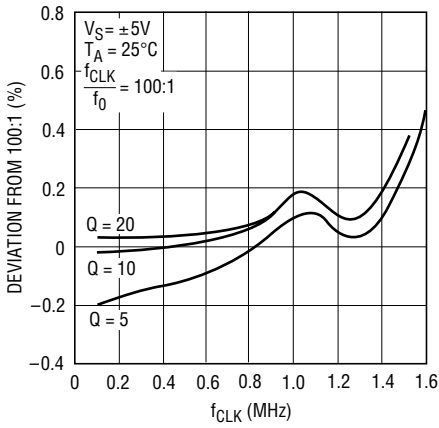

1059 G19

**Graph 20. Mode 3 (R2 = R4):
(f_{CLK}/f₀) vs f_{CLK} and Q**

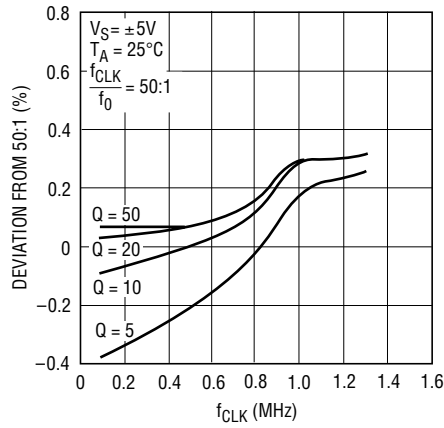

1059 G20

**Graph 21. Mode 3 (R2 = R4):
(f_{CLK}/f₀) vs f_{CLK} and Temperature**

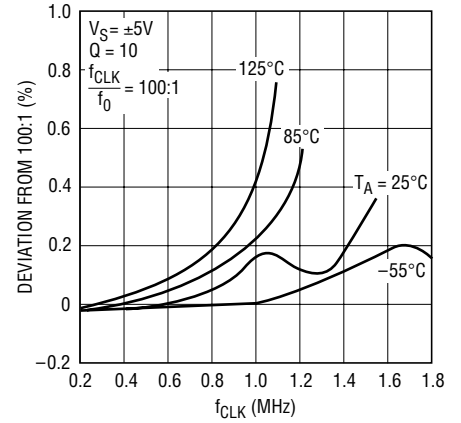

1059 G21

**Graph 22. Mode 3 (R2 = R4):
(f_{CLK}/f₀) vs f_{CLK} and Temperature**

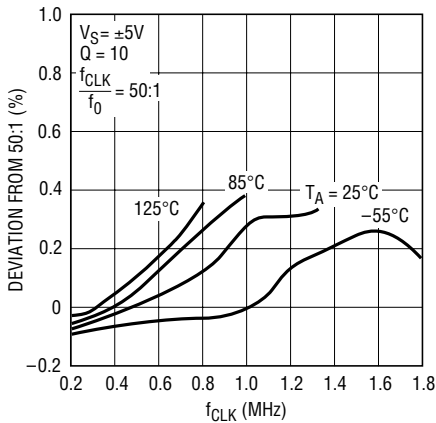

1059 G22

**Graph 23. Mode 3 (R2 = R4):
(f_{CLK}/f₀) vs f_{CLK} and Temperature**

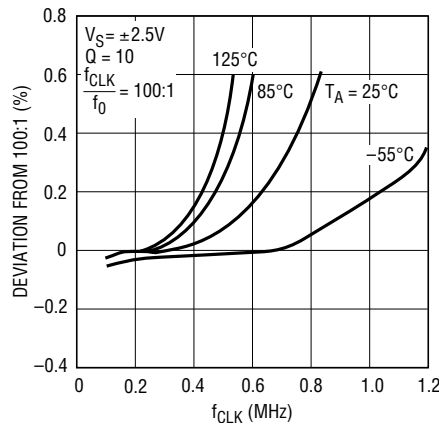

1059 G23

**Graph 24. Mode 3 (R2 = R4):
(f_{CLK}/f₀) vs f_{CLK} and Temperature**

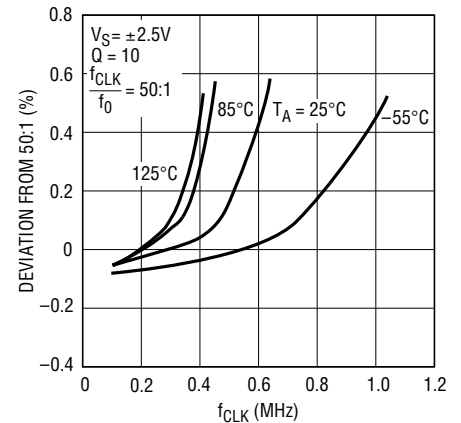

1059 G24

**Graph 25. Mode 1c (R5 = 0),
Mode 2 (R2 = R4): Q Error vs
Clock Frequency**

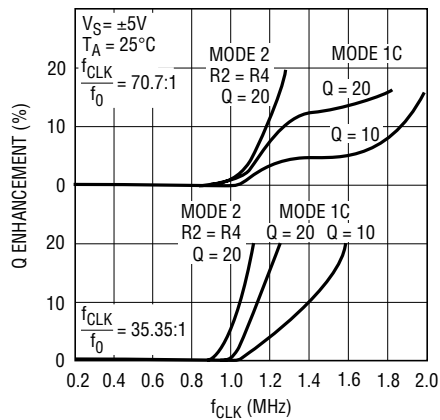

1059 G25

**Graph 26. Supply Current
vs Supply Voltage**

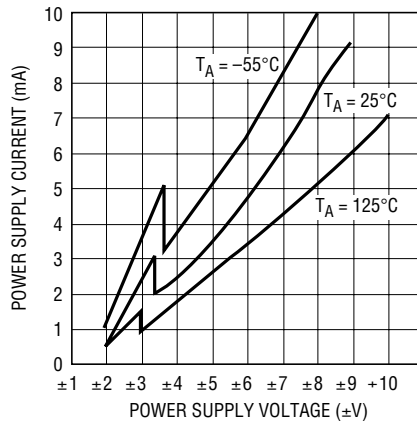

1059 G26

1059fd

BLOCK DIAGRAM

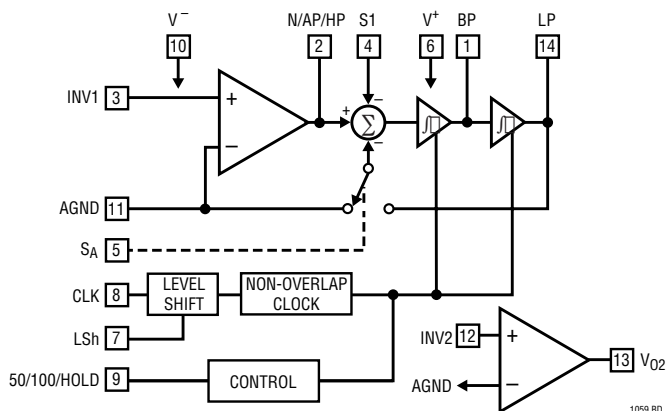

APPLICATIONS INFORMATION

The LTC1059 is compatible with the LTC1060. All the LTC1059 pins are functionally equivalent to the LTC1060 pins bearing the same title. For a detailed pin description and definition of various modes of operation refer to the LTC1060 data sheet. The LTC1059 is typically “faster” than the LTC1060 especially under single 5V (or $\pm 2.5V$) supply

operation. This becomes apparent through the Typical Performance Characteristics of the part. All the graphs shown in this data sheet have been drawn under the same test conditions as in the LTC1060 data sheet; they are also numbered in the same order. For complete discussion of the filter characteristics see the LTC1060 data sheet.

PACKAGE DESCRIPTION

J Package
14-Lead CERDIP (Narrow .300 Inch, Hermetic)
 (Reference LTC DWG # 05-08-1110)

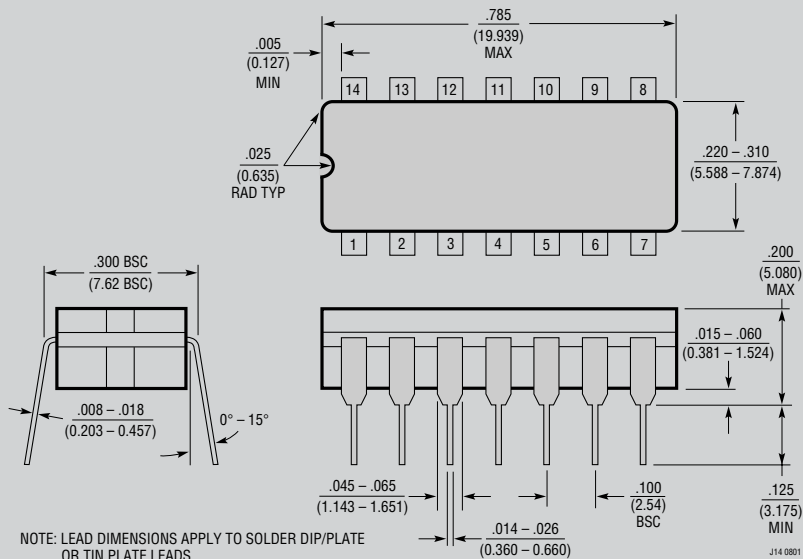

NOTE: LEAD DIMENSIONS APPLY TO SOLDER DIP/PLATE OR TIN PLATE LEADS

OBsolete PACKAGE

PACKAGE DESCRIPTION

N Package 14-Lead PDIP (Narrow .300 Inch) (Reference LTC DWG # 05-08-1510)

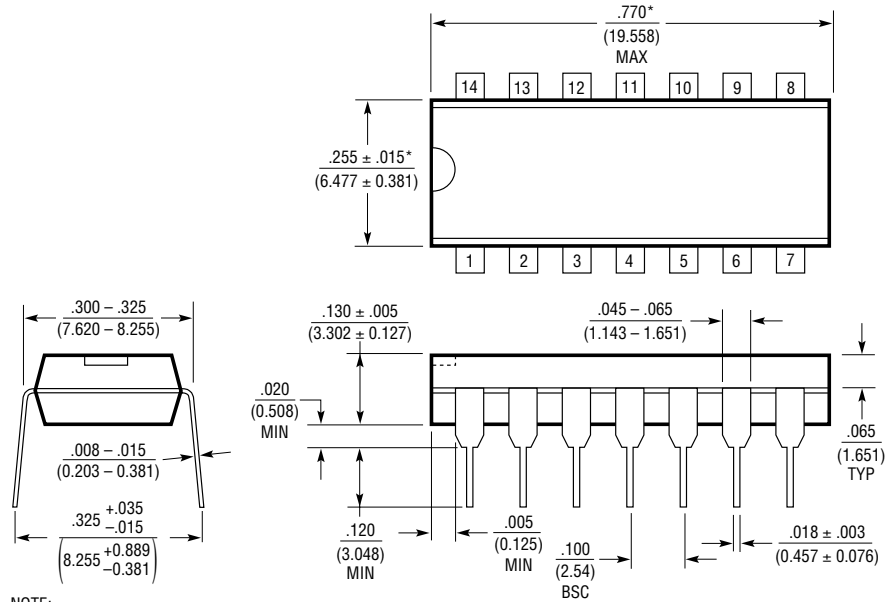

NOTE:
1. DIMENSIONS ARE $\frac{\text{INCHES}}{\text{MILLIMETERS}}$
*THESE DIMENSIONS DO NOT INCLUDE MOLD FLASH OR PROTRUSIONS.
MOLD FLASH OR PROTRUSIONS SHALL NOT EXCEED .010 INCH (0.254mm)

N14 1002

S Package 14-Lead Plastic Small Outline (Narrow .150 Inch) (Reference LTC DWG # 05-08-1610)

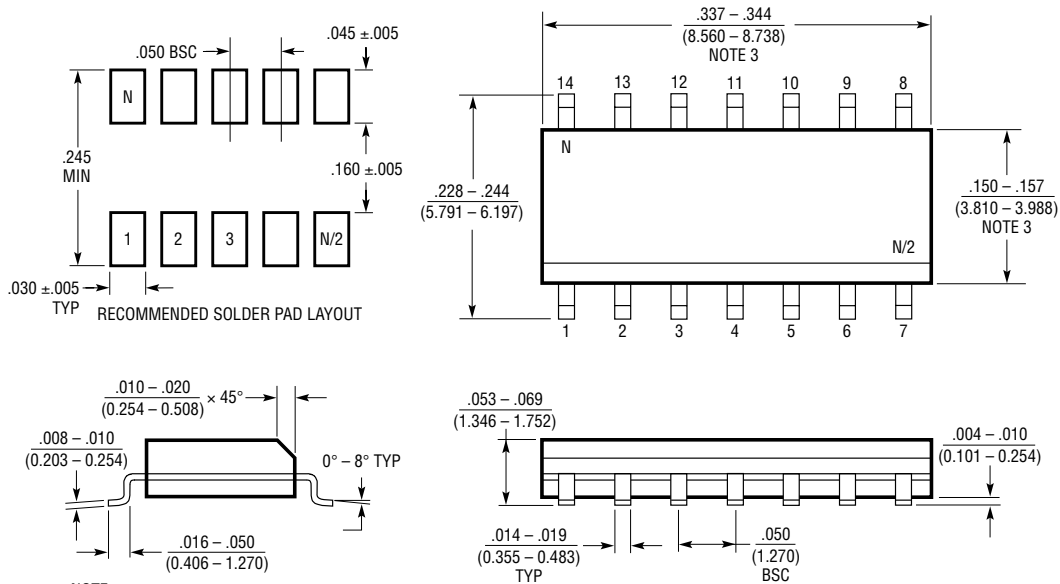

NOTE:
1. DIMENSIONS IN $\frac{\text{INCHES}}{\text{MILLIMETERS}}$
2. DRAWING NOT TO SCALE
3. THESE DIMENSIONS DO NOT INCLUDE MOLD FLASH OR PROTRUSIONS.
MOLD FLASH OR PROTRUSIONS SHALL NOT EXCEED .006" (0.15mm)

S14 0502

Mouser Electronics

Authorized Distributor

Click to View Pricing, Inventory, Delivery & Lifecycle Information:

[Analog Devices Inc.:](#)

[LTC1059CS#TR](#) [LTC1059CN](#) [LTC1059CN#PBF](#) [LTC1059CS#TRPBF](#) [LTC1059CS](#) [LTC1059CS#PBF](#)