

High temperature 30 A, 600 V D²PAK thyristor SCRs

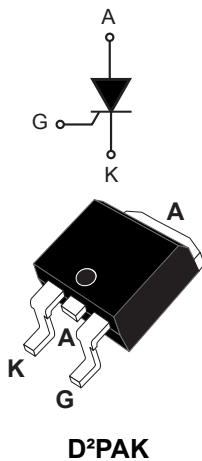

Features

- High junction temperature: $T_j = 150\text{ °C}$
- High noise immunity $dV/dt = 1000\text{ V}/\mu\text{s}$ up to 150 °C
- Gate triggering current $I_{GT} = 15\text{ mA}$
- Peak off-state voltage $V_{DRM}/V_{RRM} = 600\text{ V}$
- High turn-on current rise $di/dt = 100\text{ A}/\mu\text{s}$
- **ECOPACK2** compliant

Applications

- General purpose AC line load switching
- Motorbike voltage regulator circuits
- Inrush current limiting circuits
- Motor control circuits and starters
- Heating resistor control, Solid State Relays
- Lighting

Description

Thanks to its operating junction temperature up to 150 °C , the **TN3015H-6G** SCR in D²PAK package offers high thermal performance operation up to 30 A RMS in a compact SMD design.

Its trade-off noise immunity ($dV/dt = 1000\text{ V}/\mu\text{s}$) versus its gate triggering current ($I_{GT} = 15\text{ mA}$) and its turn-on current rise ($di/dt = 100\text{ A}/\mu\text{s}$) allows to design robust and compact control circuit for voltage regulator in motorbikes and industrial drives, overvoltage crowbar protection, motor control circuits in power tools and kitchen appliances and inrush current limiting circuits.

Product status	
TN3015H-6G	
Product summary	
Order code	TN3015H-6G
Package	D ² PAK
V_{DRM}/V_{RRM}	600 V
T_j	150 °C
I_{GT}	15 mA

1 Characteristics

Table 1. Absolute maximum ratings (limiting values)

Symbol	Parameter		Value	Unit
$I_{T(RMS)}$	RMS on-state current (180 ° conduction angle)		$T_c = 127\text{ °C}$ 30	A
$I_{T(AV)}$	Average on-state current (180 ° conduction angle)		$T_c = 127\text{ °C}$ 19	A
			$T_c = 134\text{ °C}$ 15	
			$T_c = 141\text{ °C}$ 10	
I_{TSM}	Non repetitive surge peak on-state current (T_j initial = 25 °C)		$t_p = 8.3\text{ ms}$ 295	A
			$t_p = 10\text{ ms}$ 270	
I^2t	I^2t value for fusing (T_j initial = 25 °C)		$t_p = 10\text{ ms}$ 364	A ² s
di/dt	$I_G = 2 \times I_{GT}$, $tr \leq 100\text{ ns}$ Critical rate of rise of on-state current	$f = 60\text{ Hz}$	$T_j = 25\text{ °C}$ 100	A/ μ s
V_{DRM}/V_{RRM}	Repetitive peak off-state voltage		600	V
V_{DSM}/V_{RSM}	Non repetitive surge peak off-state voltage	$t_p = 10\text{ ms}$	$T_j = 25\text{ °C}$ $V_{DRM}/V_{RRM} + 100$	V
I_{GM}	Peak gate current	$t_p = 20\text{ }\mu\text{s}$	$T_j = 150\text{ °C}$ 4	A
$P_{G(AV)}$	Average gate power dissipation		$T_j = 150\text{ °C}$ 1	W
V_{RGM}	Maximum peak reverse gate voltage		$T_j = 25\text{ °C}$ 5	V
T_{stg}	Storage junction temperature range		-40 to +150	°C
T_j	Maximum operating junction temperature		-40 to +150	°C

Table 2. Electrical characteristics ($T_j = 25\text{ °C}$ unless otherwise specified)

Symbol	Test conditions		Value	Unit	
I_{GT}	$V_D = 12\text{ V}$, $R_L = 33\text{ }\Omega$		Min.	6	mA
			Max.	15	
V_{GT}			Max.	1.3	V
V_{GD}	$V_D = V_{DRM}$, $R_L = 3.3\text{ k}\Omega$	$T_j = 150\text{ °C}$	Min.	0.15	V
I_H	$I_T = 500\text{ mA}$, gate open		Max.	60	mA
I_L	$I_G = 1.2 \times I_{GT}$		Max.	75	mA
dV/dt	$V_D = 402\text{ V}$, gate open	$T_j = 150\text{ °C}$	Min.	1000	V/ μ s
t_{gt}	$I_T = 60\text{ A}$, $V_D = 600\text{ V}$, $I_G = 100\text{ mA}$, $(di_G/dt)_{max} = 0.2\text{ A}/\mu\text{s}$		Typ.	1.9	μ s
t_q	$I_T = 30\text{ A}$, $V_D = 402\text{ V}$, $(di/dt)_{off} = 30\text{ A}/\mu\text{s}$, $V_R = 25\text{ V}$, $dV_D/dt = 50\text{ V}/\mu\text{s}$	$T_j = 150\text{ °C}$	Typ.	80	μ s

Table 3. Static characteristics

Symbol	Test conditions			Value	Unit
V_{TM}	$I_{TM} = 60\text{ A}$, $t_p = 380\ \mu\text{s}$	$T_j = 25\ ^\circ\text{C}$	Max.	1.6	V
V_{TO}	Threshold voltage	$T_j = 150\ ^\circ\text{C}$	Max.	0.84	
R_D	Dynamic resistance	$T_j = 150\ ^\circ\text{C}$	Max.	14	m Ω
I_{DRM} , I_{RRM}	$V_D = V_{DRM}$, $V_R = V_{RRM}$	$T_j = 25\ ^\circ\text{C}$	Max.	10	μA
		$T_j = 150\ ^\circ\text{C}$		5	mA

Table 4. Thermal parameters

Symbol	Parameter	Value	Unit
$R_{th(j-c)}$	Junction to case (DC)	Max. 0.85	$^\circ\text{C/W}$
$R_{th(j-a)}$	Junction to ambient ⁽¹⁾ $S(1) = 1\ \text{cm}^2$	Typ. 45	

1. S : Copper pad under tab, on PCB FR4

1.1 Characteristics curves

Figure 1. Maximum power dissipation versus average on-state current

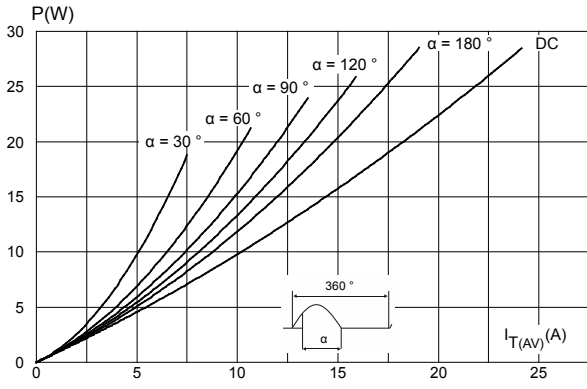

Figure 2. Average and DC on-state current versus case temperature

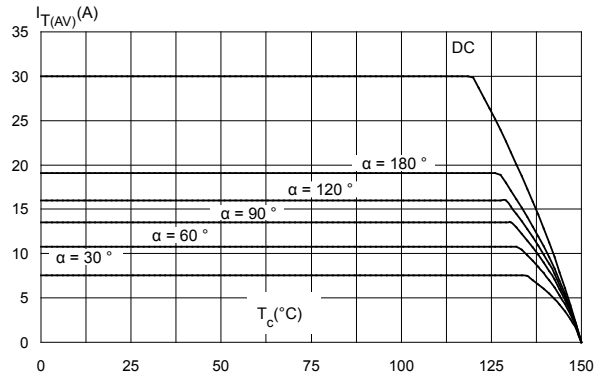

Figure 3. Average and D.C. on state current versus ambient temperature

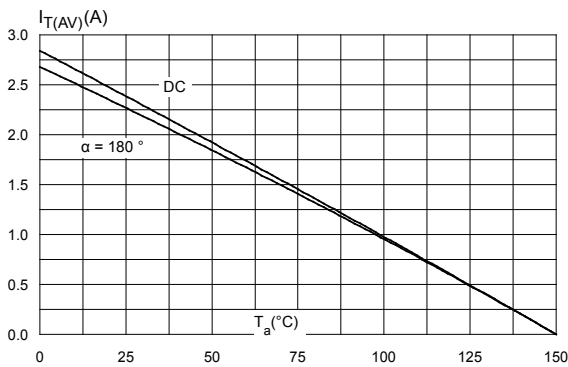

Figure 4. On-state characteristics (maximum values)

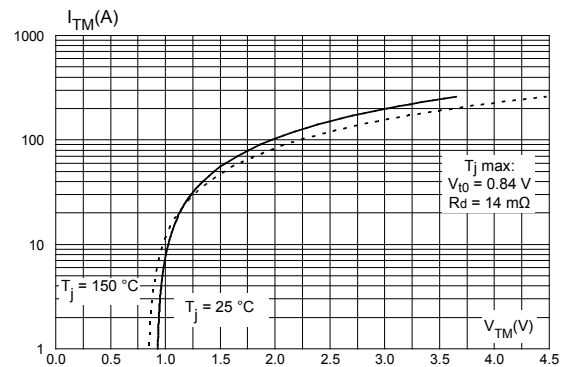

Figure 5. Relative variation of thermal impedance junction to case and junction to ambient versus pulse duration

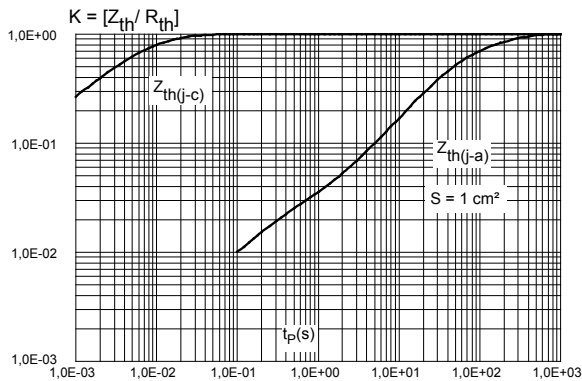

Figure 6. Relative variation of gate trigger current and gate voltage versus junction temperature (typical values)

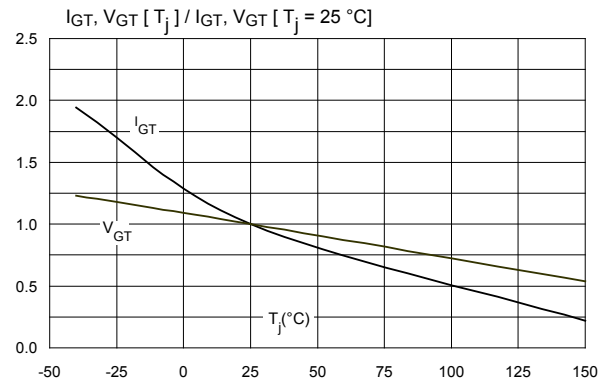

Figure 7. Relative variation of holding and latching current versus junction temperature (typical values)

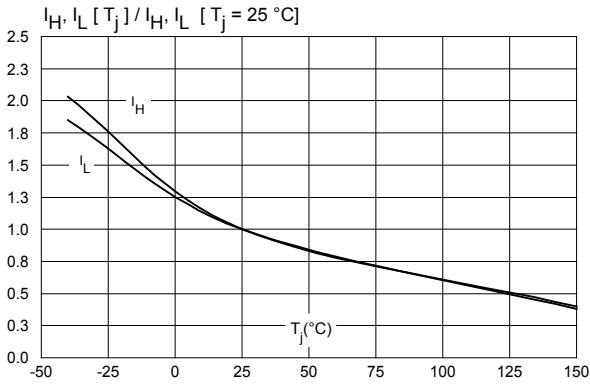

Figure 8. Relative variation of static dV/dt immunity versus junction temperature (typical values)

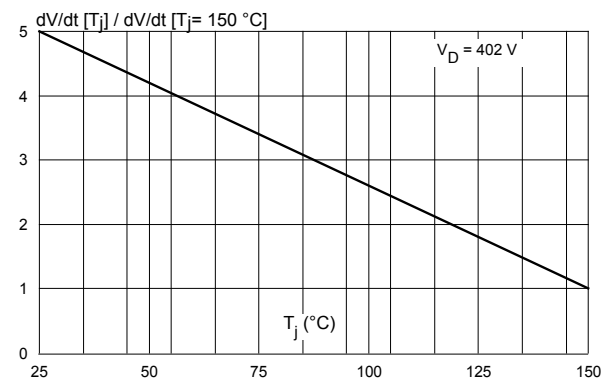

Figure 9. Surge peak on-state current versus number of cycles

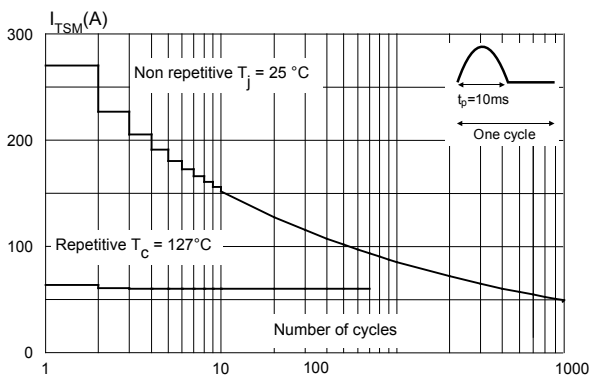

Figure 10. Non repetitive surge peak on-state current for a sinusoidal pulse with width $t_p < 10$ ms

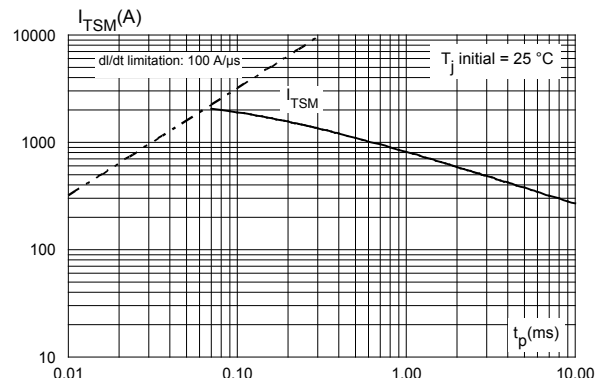

Figure 11. Relative variation of leakage current versus junction temperature

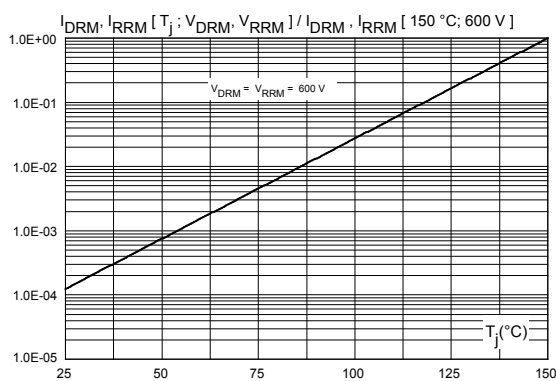
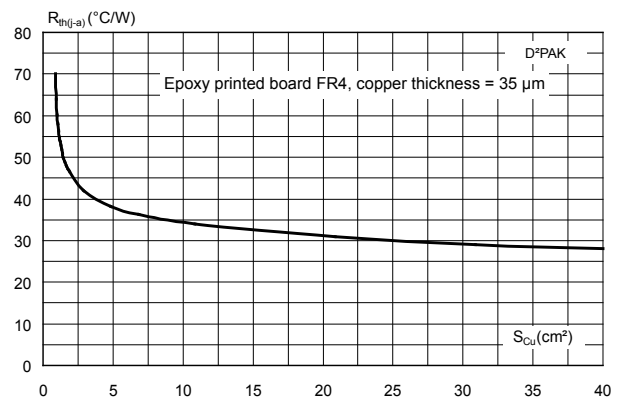

Figure 12. Thermal resistance junction to ambient versus copper surface under tab



2 Package information

In order to meet environmental requirements, ST offers these devices in different grades of **ECOPACK** packages, depending on their level of environmental compliance. ECOPACK specifications, grade definitions and product status are available at: www.st.com. ECOPACK is an ST trademark.

2.1 D²PAK package information

- ECOPACK[®]2 compliant
- Lead-free package leads finishing
- Molding compound resin is halogen-free and meets UL standard level V0

Figure 13. D²PAK package outline

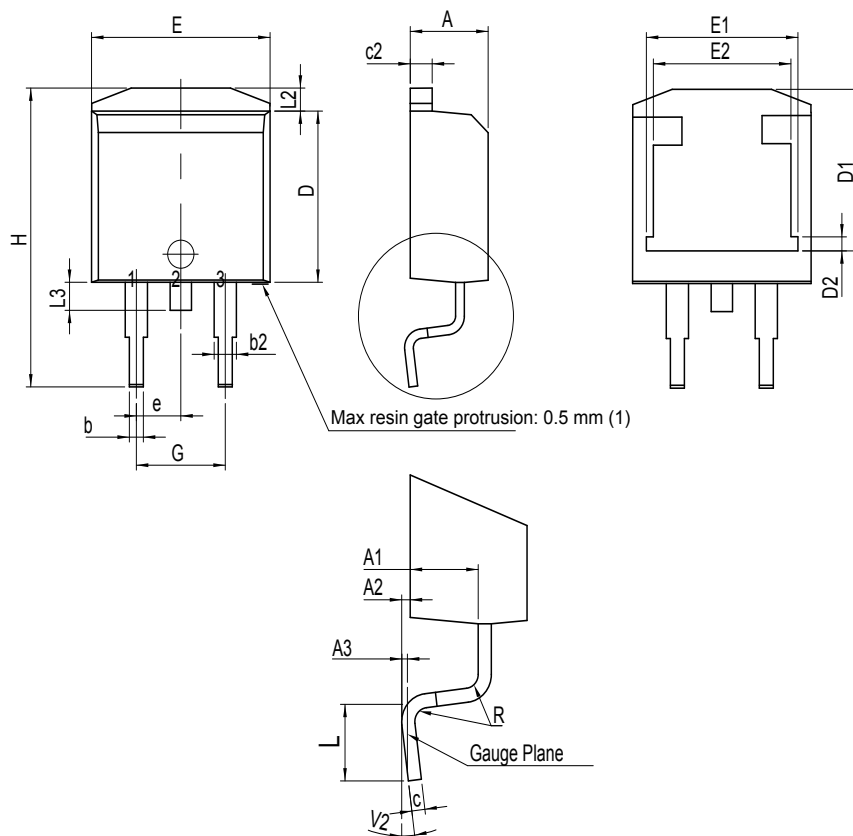

(1) Resin gate is accepted in each of position shown on the drawing, or their symmetrical.

Table 5. D²PAK package mechanical data

Ref.	Dimensions					
	Millimeters			Inches ⁽¹⁾		
	Min.	Typ.	Max.	Min.	Typ.	Max.
A	4.30		4.60	0.1693		0.1811
A1	2.49		2.69	0.0980		0.1059
A2	0.03		0.23	0.0012		0.0091
A3		0.25			0.0098	
b	0.70		0.93	0.0276		0.0366
b2	1.25		1.7	0.0492		0.0669
c	0.45		0.60	0.0177		0.0236
c2	1.21		1.36	0.0476		0.0535
D	8.95		9.35	0.3524		0.3681
D1	7.50		8.00	0.2953		0.3150
D2	1.30		1.70	0.0512		0.0669
e	2.54			0.10000		
E	10.00		10.28	0.3937		0.4047
E1	8.30		8.70	0.3268		0.3425
E2	6.85		7.25	0.2697		0.2854
G	4.88		5.28	0.1921		0.2079
H	15		15.85	0.5906		0.6240
L	1.78		2.28	0.0701		0.0898
L2	1.27		1.40	0.0500		0.0551
L3	1.40		1.75	0.0551		0.0689
R		0.40			0.0157	
V2 ⁽²⁾	0°		8°	0°		8°

1. Dimensions in inches are given for reference only

2. Degrees

Figure 14. D²PAK recommended footprint (dimensions are in mm)

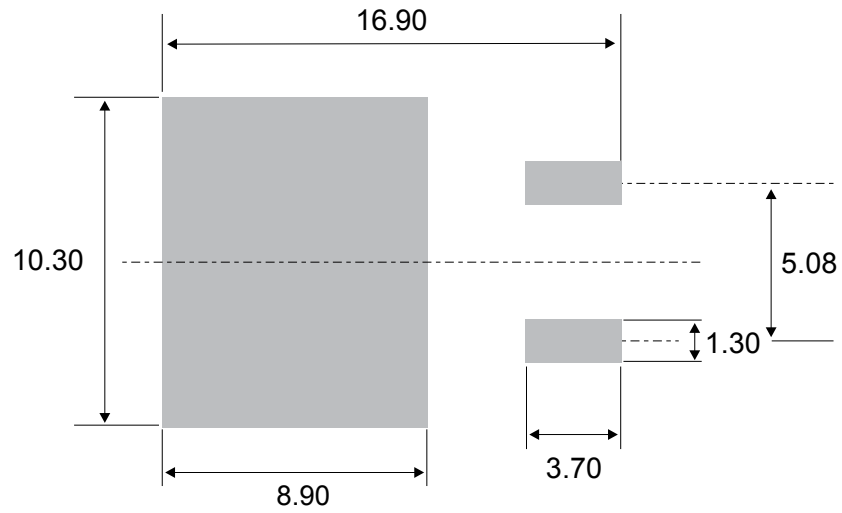
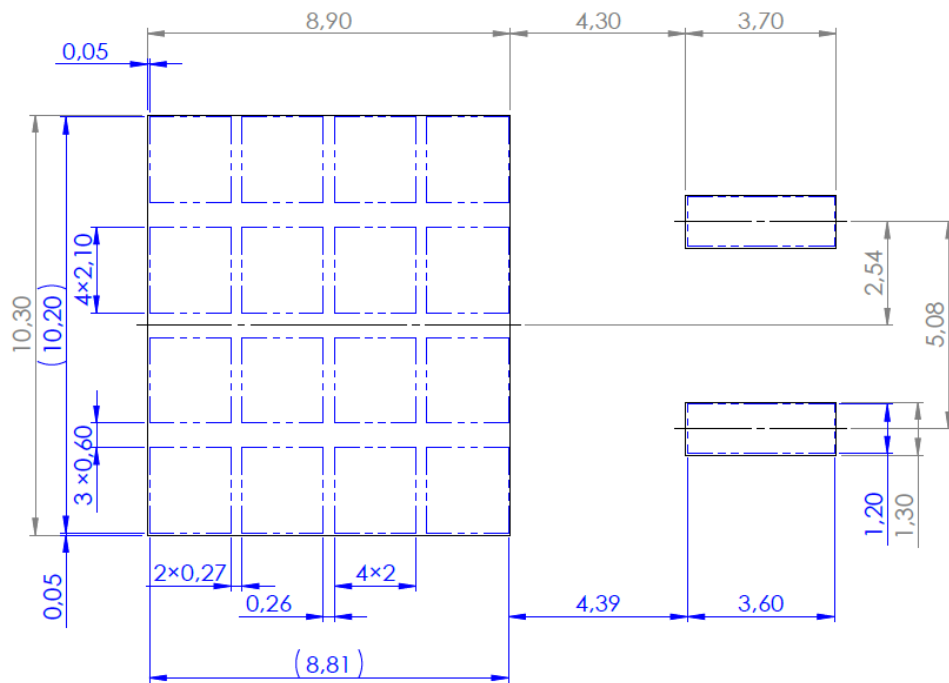

Figure 15. D²PAK stencil definitions (dimensions are in mm)



3 Ordering information

Figure 16. Ordering information scheme

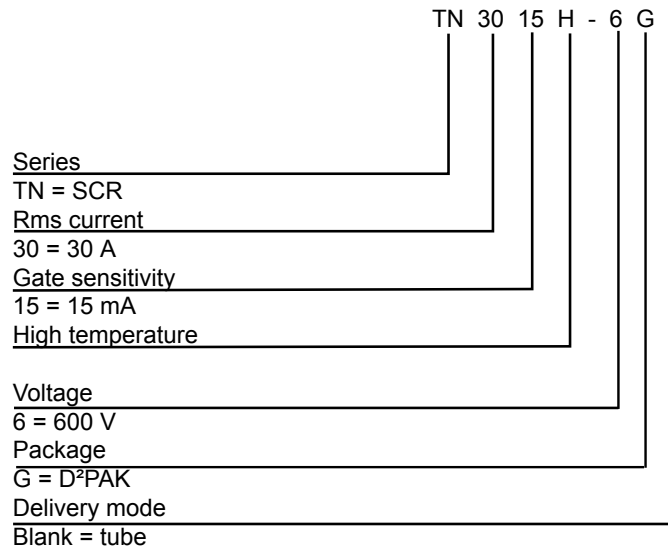

Table 6. Ordering information

Order code	Marking	Package	Weight	Base qty.	Delivery mode
TN3015H-6G-TR	TN3015H6G	D ² PAK	1.5 g	1000	Tape and Reel
TN3015H-6G				50	Tube

Revision history

Table 7. Document revision history

Date	Revision	Changes
05-Jul-2019	1	Initial release.

IMPORTANT NOTICE – PLEASE READ CAREFULLY

STMicroelectronics NV and its subsidiaries (“ST”) reserve the right to make changes, corrections, enhancements, modifications, and improvements to ST products and/or to this document at any time without notice. Purchasers should obtain the latest relevant information on ST products before placing orders. ST products are sold pursuant to ST’s terms and conditions of sale in place at the time of order acknowledgement.

Purchasers are solely responsible for the choice, selection, and use of ST products and ST assumes no liability for application assistance or the design of Purchasers’ products.

No license, express or implied, to any intellectual property right is granted by ST herein.

Resale of ST products with provisions different from the information set forth herein shall void any warranty granted by ST for such product.

ST and the ST logo are trademarks of ST. For additional information about ST trademarks, please refer to www.st.com/trademarks. All other product or service names are the property of their respective owners.

Information in this document supersedes and replaces information previously supplied in any prior versions of this document.

© 2019 STMicroelectronics – All rights reserved

Mouser Electronics

Authorized Distributor

Click to View Pricing, Inventory, Delivery & Lifecycle Information:

[STMicroelectronics:](#)

[TN3015H-6G](#) [TN3015H-6G-TR](#)