

THIS IS A C.A.D. GENERATED DRAWING  
DO NOT MAKE MANUAL REVISIONS TO MASTER.

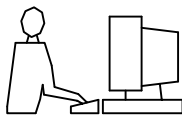

\* UNLESS OTHERWISE SPECIFIED TOLERANCES  
ON DECIMAL IS:

X.X  
X.XX  
X.XXX

ISSUE NUMBER

ORIGINAL ①

DIM 1.6 WAS 1.3 ②  
R.STA.MONICA SEPT.24/2012

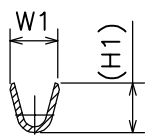
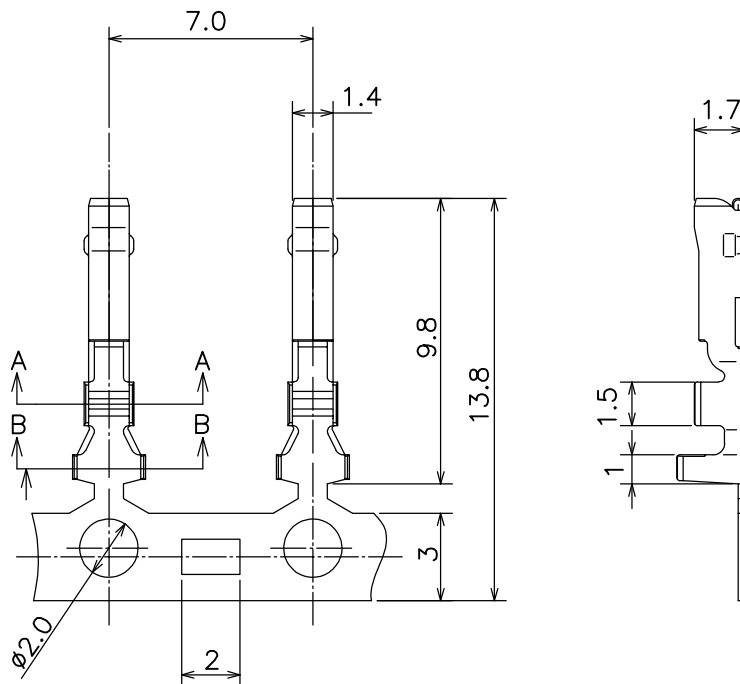

SECTION A-A

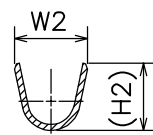

SECTION B-B

NOTES

MATERIAL: PHOSPHOR BRONZE  
0.2mm THICK  
TIN PLATED ALL OVER

PART NO	W1	H1	W2	H2	WIRE RANGE	INSULATION DIA
565-290-721	1.7	1.7	2.6	2.4	AWG # 22~28	MAXIMUM $\phi$ 1.6
565-290-741	1.9	1.9	3.0	2.7	AWG # 20~22	MAXIMUM $\phi$ 1.7

②

***SOCKET CONTACT***

ACAD REFERENCE NO. 565-290-721 & 741

DRAWN: N.SONDH

DATE: SEP 10/12

CHECKED:

DATE:

SCALE: (IN C.A.D.1:1)

SHEET 1 OF 3

DRAWING NUMBER

565-290-721 & 741

ISSUE

2



EDAC INC  
TORONTO, ONTARIO  
CANADA

YOUR CONNECTION TO QUALITY & SERVICE

THESE DRAWINGS AND SPECIFICATIONS  
ARE THE PROPERTY OF EDAC INC., AND  
SHALL NOT BE REPRODUCED, OR COPIED  
OR USED AS THE BASIS FOR THE  
MANUFACTURE OR SALE OF APPARATUS  
WITHOUT WRITTEN PERMISSION.

THIS IS A C.A.D. GENERATED DRAWING  
DO NOT MAKE MANUAL REVISIONS TO MASTER.

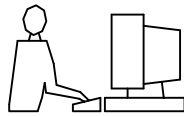

\* UNLESS OTHERWISE SPECIFIED TOLERANCES  
ON DECIMAL IS:

X.X  
X.XX  
X.XXX

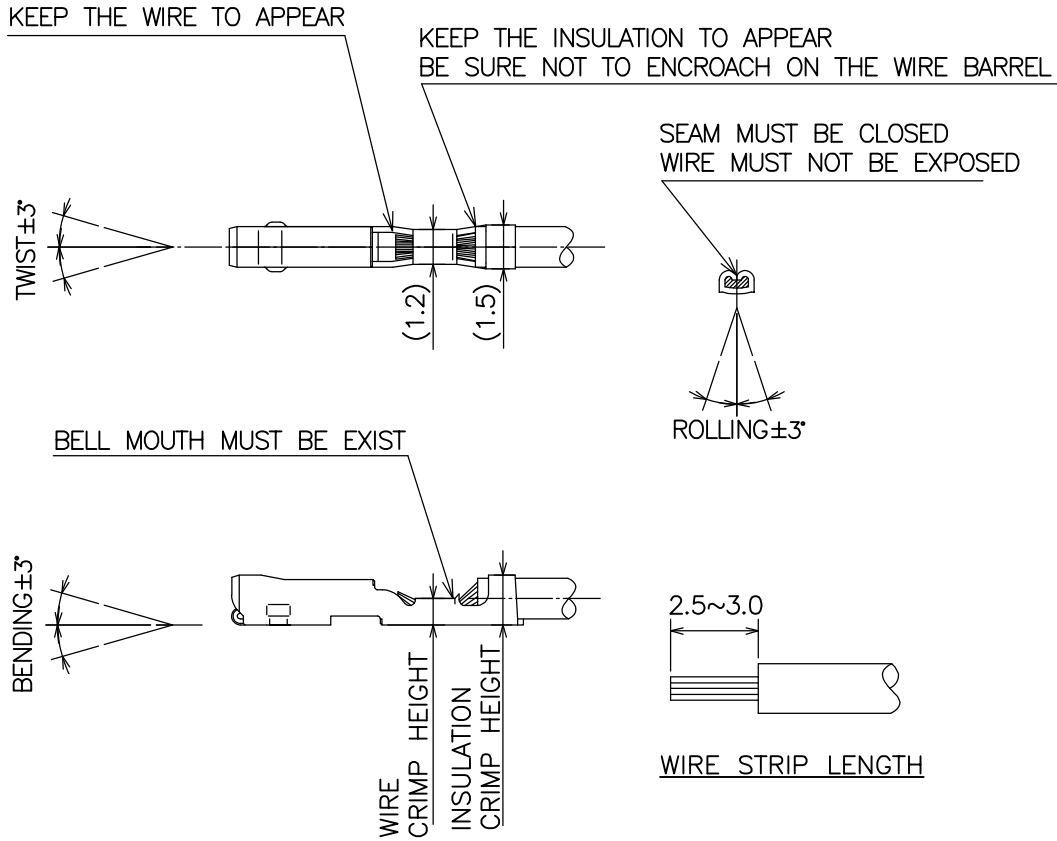

WIRE CRIMP INFORMATION FOR 565-290-721 CONTACT  
WITH INSULATION DIA 1.0mm TO 1.3mm  
(565-290-721 CONTACT TO BE CRIMPED WITH TOOL# 565-280-210)

WIRE SIZE	INSULATION DIA	WIRE CRIMP HEIGHT	INSULATION CRIMP HEIGHT	CRIMP STRENGTH
AWG # 22	-----	0.80±0.03	1.7 MAX	49.0 N(5.0Kgf)MIN
AWG # 24	-----	0.75±0.03	1.7 MAX	29.4 N(3.0Kgf)MIN
AWG # 26	-----	0.67±0.03	1.7 MAX	19.6 N(2.0Kgf)MIN
AWG # 28	-----	0.63±0.03	1.7 MAX	9.8 N(1.0Kgf)MIN

# SOCKET CONTACT

## WIRE CRIMP INFORMATION

ACAD REFERENCE NO. 565-290-721 & 741

DRAWN: N.SONDH

DATE: SEP 10/12

CHECKED:

DATE:

SCALE: (IN C.A.D.1:1)

SHEET 2 OF 3

DRAWING NUMBER

ISSUE

565-290-721 & 741

2



EDAC INC  
TORONTO, ONTARIO  
CANADA

YOUR CONNECTION TO QUALITY & SERVICE

THESE DRAWINGS AND SPECIFICATIONS  
ARE THE PROPERTY OF EDAC INC., AND  
SHALL NOT BE REPRODUCED, OR COPIED  
OR USED AS THE BASIS FOR THE  
MANUFACTURE OR SALE OF APPARATUS  
WITHOUT WRITTEN PERMISSION.

THIS IS A C.A.D. GENERATED DRAWING  
DO NOT MAKE MANUAL REVISIONS TO MASTER.

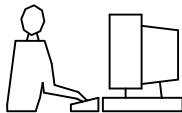

\* UNLESS OTHERWISE SPECIFIED TOLERANCES  
ON DECIMAL IS:

X.X  
X.XX  
X.XXX

KEEP THE WIRE TO APPEAR

KEEP THE INSULATION TO APPEAR  
BE SURE NOT TO ENCROACH ON THE WIRE BARREL

SEAM MUST BE CLOSED  
WIRE MUST NOT BE EXPOSED

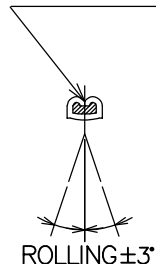
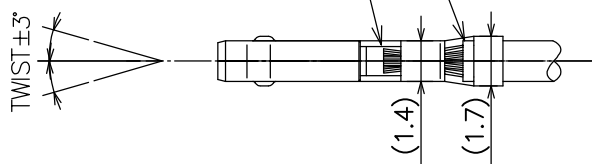

BELL MOUTH MUST BE EXIST

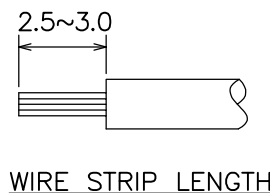
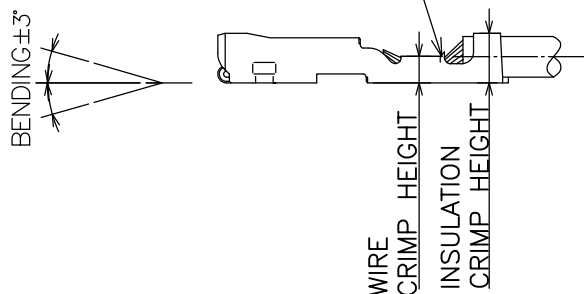

WIRE CRIMP INFORMATION FOR 565-290-741 CONTACT  
WITH INSULATION DIA 1.3mm TO 1.7mm  
(565-290-741 CONTACT TO BE CRIMPED WITH TOOL# 565-280-211)

WIRE SIZE	INSULATION DIA	WIRE CRIMP HEIGHT	INSULATION CRIMP HEIGHT	CRIMP STRENGTH
AWG # 20	-----	0.87±0.03	1.8 MAX	68.6 N(7.0Kgf)MIN
AWG # 22	-----	0.81±0.03	1.8 MAX	49.0 N(5.0Kgf)MIN

# SOCKET CONTACT

## WIRE CRIMP INFORMATION

ACAD REFERENCE NO. 565-290-721 & 741

DRAWN: N.SONDH

DATE: SEP 10/12

CHECKED:

DATE:

SCALE: (IN C.A.D.1:1)

SHEET 3 OF 3

DRAWING NUMBER

ISSUE

565-290-721 & 741

2



EDAC INC  
TORONTO, ONTARIO  
CANADA

YOUR CONNECTION TO QUALITY & SERVICE

THESE DRAWINGS AND SPECIFICATIONS  
ARE THE PROPERTY OF EDAC INC., AND  
SHALL NOT BE REPRODUCED, OR COPIED  
OR USED AS THE BASIS FOR THE  
MANUFACTURE OR SALE OF APPARATUS  
WITHOUT WRITTEN PERMISSION.

# Mouser Electronics

Authorized Distributor

Click to View Pricing, Inventory, Delivery & Lifecycle Information:

[EDAC:](#)

[565-290-721](#) [565-290-741](#)