

NTAG203

NFC Forum Type 2 Tag compliant IC with 144 bytes user memory

Rev. 3.0 — 17 October 2011
213830

Product data sheet
COMPANY PROPRIETARY

1. General description

NXP Semiconductors has developed NTAG203 - NFC Forum Type 2 Tag compliant IC - to be used with NFC enabled devices according to NFC Forum technical specifications (see [Ref. 10](#) and [Ref. 11](#)), according to NFC Forum recommendations or Proximity Coupling Devices (PCD), according to ISO/IEC 14443A (see [Ref. 1](#)). The communication layer (RF Interface) complies to parts 2 and 3 of the ISO/IEC 14443A standard. The NTAG203 is primarily designed for NFC Forum Type 2 Tag applications (i.e. Smart Advertisement, connection handover, Bluetooth simple pairing, WiFi Protected set-up, call request, SMS, goods and device authentication and others).

1.1 Contactless energy and data transfer

Communication to NTAG can be established only when the IC is connected to a coil. Form and specification of the coil is out of scope of this document.

When the NTAG is positioned in the RF field, the high speed RF communication interface allows the transmission of the data with a baud rate of 106 kbit/s.

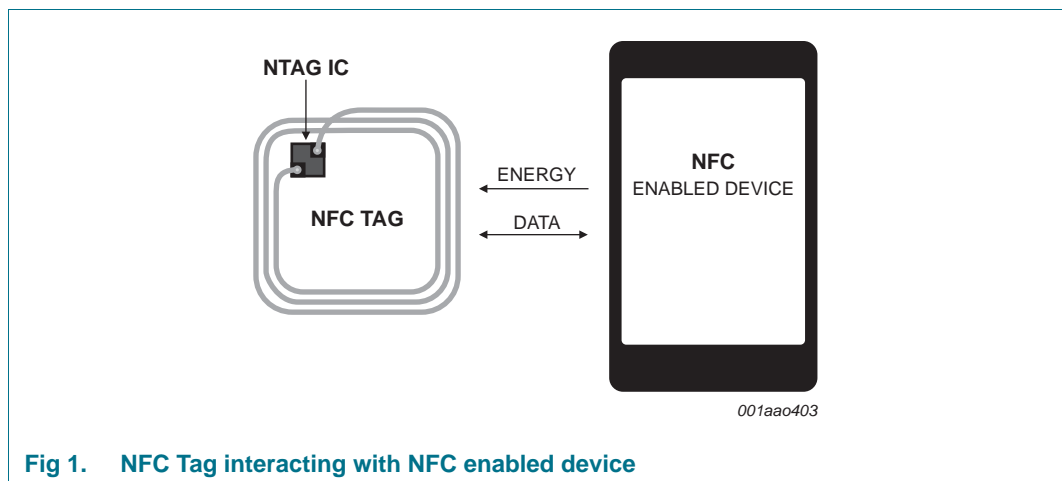

Fig 1. NFC Tag interacting with NFC enabled device

1.2 Naming conventions

Table 1. Short naming convention (for easier product identification)

Family name	Description
NTAG	NXP NFC Tag product family name
2	Platform indicator
0	Generation number (starting from 0)
3	Code number for memory size (0 : < 64 bytes, 1 : 64-96 bytes; 2 : 96-128 bytes; 3 : 128-256 bytes)
F	Delivery option: if stated, it is a HWSO8 package with Field Detection pin

2. Features and benefits

2.1 RF Interface (ISO/IEC 14443A)

- Contactless transmission of data and supply energy (no battery needed)
- Operating distance: up to 100 mm (depending on field strength and antenna geometry)
- Operating frequency: 13.56 MHz
- Fast data transfer: 106 kbit/s
- High data integrity: 16-bit CRC, parity, bit coding, bit counting
- True anticollision
- 7 byte serial number (cascade level 2 according to ISO/IEC 14443-3)

2.2 EEPROM

- 168 bytes of total memory, divided in 42 pages (4 bytes each)
- 144 bytes of user r/w memory area, divided in 36 pages (4 bytes each)
- Field programmable read-only locking function per page for first 64 bytes
- Field programmable read-only locking function per block
- 32-bit user definable One-Time Programmable (OTP) area
- 16-bit counter
- Data retention of 5 years
- Write endurance 10000 cycles

2.3 NFC Forum Tag 2 Type compliance

NTAG203 IC provides full compliance to the NFC Forum Tag 2 Type technical specification (see [Ref. 10](#)) and enables NDEF data structure configurations (see [Ref. 11](#)).

2.4 Security

- Anti-cloning support by unique 7-byte serial number for each device
- 32-bit user programmable OTP area
- Field programmable read-only locking function per page for first 512 bits
- Read-only locking per block for rest of memory

2.5 Cascaded UID

The anticollision function is based on an IC individual serial number called Unique Identifier. The UID of the NTAG203 is 7 bytes long and supports cascade level 2 according to ISO/IEC 14443-3.

2.6 Anticollision

An intelligent anticollision function according to ISO/IEC 14443 allows to operate more than one card in the field simultaneously. The anticollision algorithm selects each card individually and ensures that the execution of a transaction with a selected card is performed correctly without data corruption resulting from other cards in the field.

3. Ordering information

Table 2. Ordering information

Type number	Package		Version
	Name	Description	
MF0ICU1701NDUD	wafer	8 inch wafer (sawn, laser diced; 120 μm thickness, - on film frame carrier; electronic fail die marking according to SECSII format)	

4. Block diagram

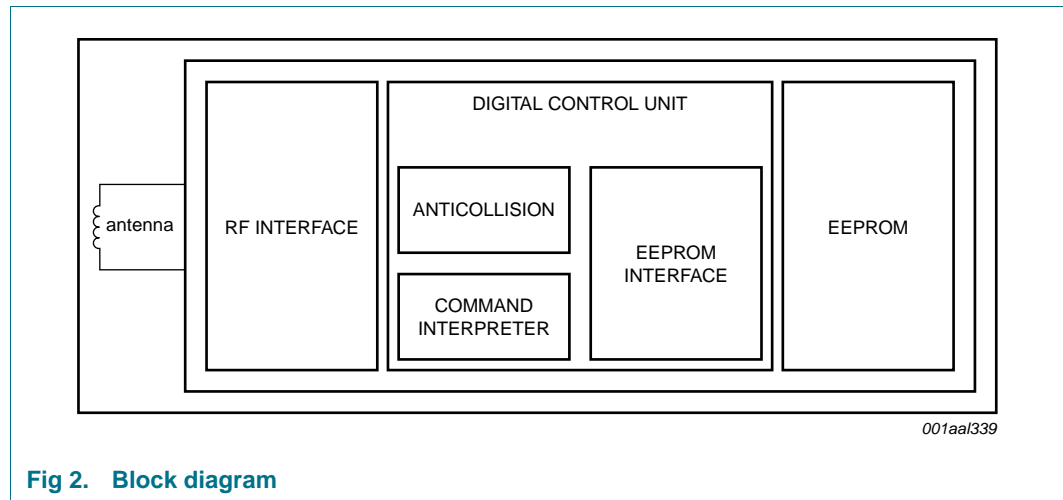

Fig 2. Block diagram

5. Pinning information

5.1 Pin description

This section is not applicable for this device.

6. Wafer layout

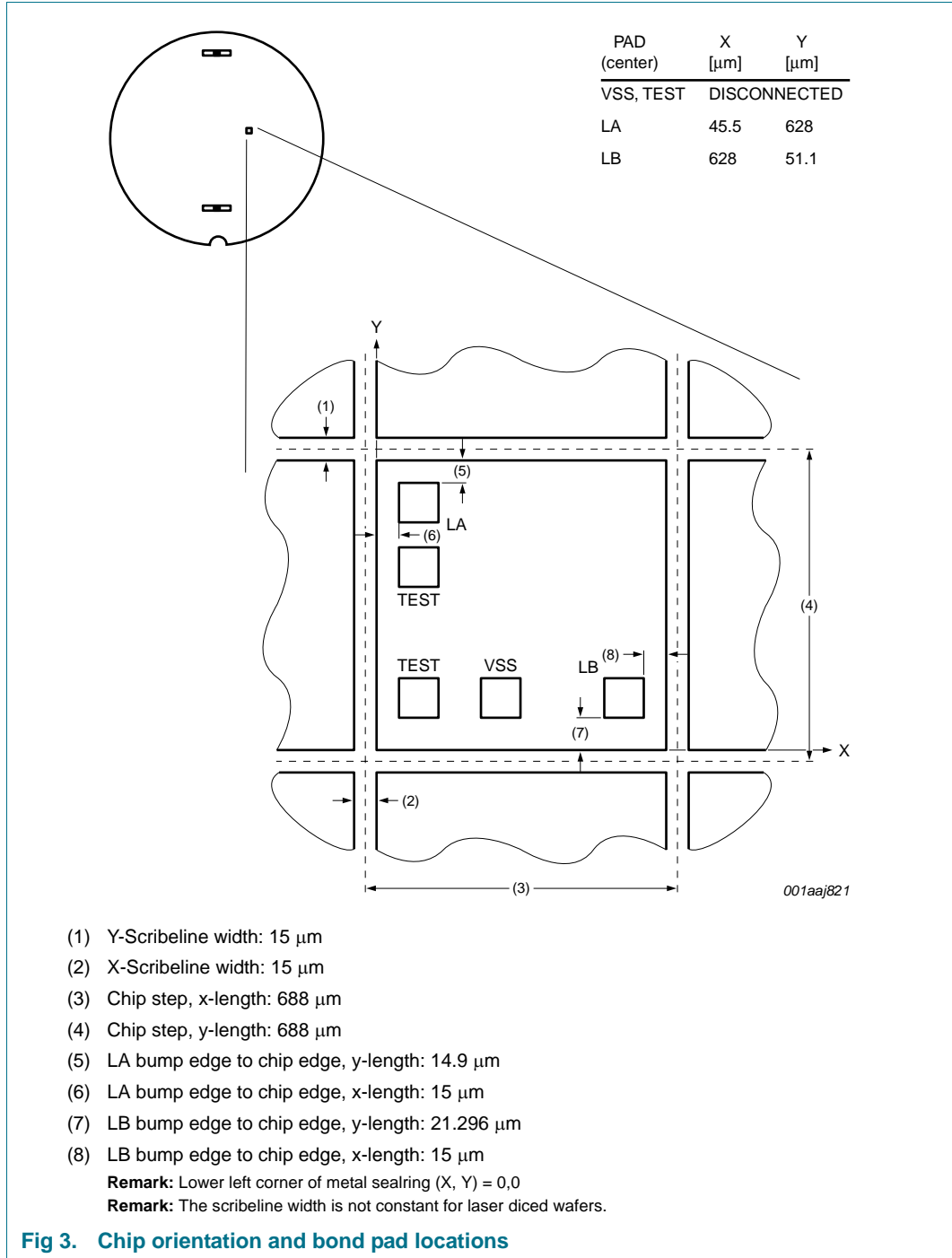

Fig 3. Chip orientation and bond pad locations

Table 3. Bonding pad assignments to smart card contactless module

Contactless interface module		NTAG203
Antenna contacts	Symbol	Description
LA	LA	Antenna coil connection LA
LB	LB	Antenna coil connection LB

7. Mechanical specification

Table 4. Wafer specifications

Wafer	
diameter	8" wafer, 200 mm unsawn min: 200 mm typ: 206 mm max: 210 mm
thickness	120 $\mu\text{m} \pm 15 \mu\text{m}$
flatness	not applicable
Potential Good Dies per Wafer (PGDW)	61942
Sawing method	laser dicing
Wafer backside	
material	Si
treatment	ground and stress relieve
roughness	R_a max 0.2 μm R_t max 2 μm
Chip dimensions	
chip size	0.673 mm \times 0.673 mm
scribe lines	x-line: 15 $\mu\text{m} \pm 5 \mu\text{m}$ y-line: 15 $\mu\text{m} \pm 5 \mu\text{m}$
Passivation	
type	sandwich structure
material	Nitride
thickness	1.75 μm
Au bump	
material	> 99.9 % pure Au
hardness	35 – 80 HV 0.005
shear strength	> 70 MPa
height	18 μm
height uniformity	
within a die	$\pm 2 \mu\text{m}$
within a wafer	$\pm 3 \mu\text{m}$
wafer to wafer	$\pm 4 \mu\text{m}$
flatness	$\pm 1.5 \mu\text{m}$
size	
LA, LB	60 $\mu\text{m} \times 60 \mu\text{m}$
TP1, TP2, VSS	60 $\mu\text{m} \times 60 \mu\text{m}$
size variation	$\pm 5 \mu\text{m}$
under bump metallization	sputtered TiW

Remark: Substrate is connected to VSS.

7.1 Fail die identification

Electronic wafer mapping covers the electrical test results and additionally the results of mechanical/ visual inspection.

No inkdots are applied.

8. Functional description

8.1 Block description

The NTAG203 chip consists of the 168 bytes of the total memory organized in 42 user memory EEPROM. From that amount, 144 bytes (36 pages) are available for the user defined data.

Along with the memory, NTAG203 contains the RF-Interface and the Digital Control Unit. Energy and data are transferred via an antenna, which consists of a coil with a few turns directly connected to the LA and LB of the NTAG203 (see [Section 5](#) for details). No further external components are necessary. (For details on antenna design please refer to the document [Ref. 6 “\(Card\) Coil Design Guide”](#).)

8.2 State diagram and logical states description

Commands are initiated by the NFC device and controlled by the NTAG203 command interpreter. This processes the internal states and generates the appropriate response.

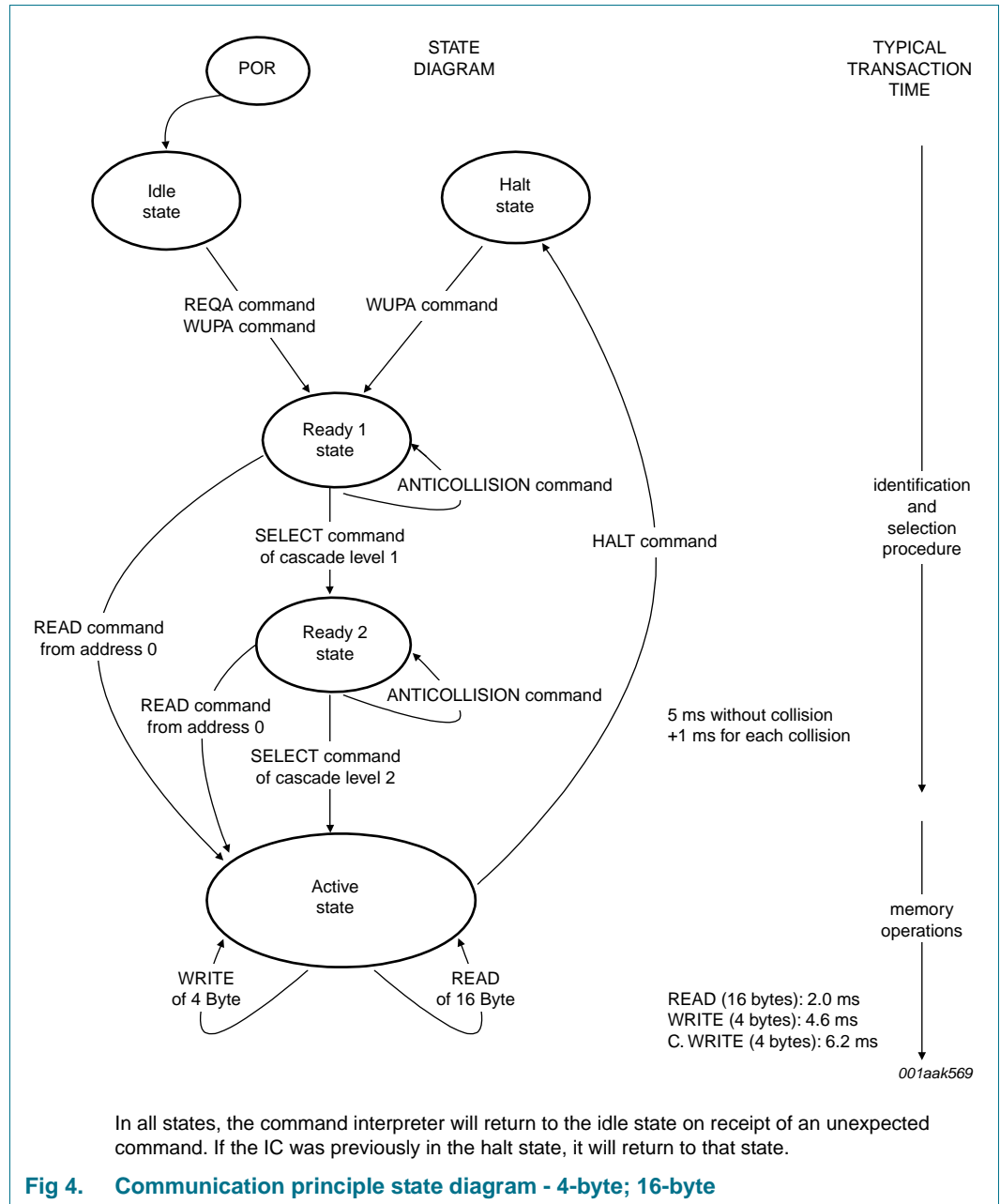

8.2.1 Idle state

After a Power-On Reset (POR), the NTAG203 switches directly to the idle state. It only exits this state when a REQA or a WUPA command is received from the NFC device. Any other data received while in the idle state is interpreted as an error and the NTAG203 remains Idle.

After a correctly executed HALT command, the halt state changes to the wait state which can be exited with a WUPA command.

8.2.2 Ready1 state

In this state, the NTAG203 supports the NFC device when resolving the first part of its UID (3 bytes) with the ANTICOLLISION or SELECT command from cascade level 1. This state is exited correctly after execution of either of the following commands:

- SELECT command from cascade level 1: the NFC device switches NTAG203 into Ready2 state where the second part of the UID is resolved.
- READ command (from address 0): all anticollision mechanisms are bypassed and NTAG203 switches directly to the active state.

Remark: If more than one NTAG203 is in the NFC device field, a READ command from address 0 causes a collision due to the different serial numbers and all NTAG203 devices are selected. Any other data received in the Ready1 state is interpreted as an error and depending on its previous state the NTAG203 returns to the wait, idle or halt state.

8.2.3 Ready2 state

In this state, the NTAG203 supports the NFC device when resolving the second part of its UID (4 bytes) with the cascade level 2 ANTICOLLISION command. This state is usually exited using the cascade level 2 SELECT command.

Alternatively, state Ready2 may be skipped using a READ command (from address 0) as described in state Ready1.

Remark: If more than one NTAG203 is in the NFC device field, a READ command from address 0 causes a collision due to the different serial numbers and all NTAG203 devices are selected. The response of the NTAG203 to the cascade level 2 SELECT command is the Select Acknowledge (SAK) byte. In accordance with ISO/IEC 14443 this byte indicates if the anticollision cascade procedure has finished. It also defines the type of device selected for the MIFARE architecture platform. The NTAG203 is now uniquely selected and only this device will communicate with the NFC device even when other contactless devices are present in the NFC device field. Any other data received when the device is in this state is interpreted as an error and depending on its previous state the NTAG203 returns to the wait, idle or halt state.

8.2.4 Active state

In the active state either a 16-byte READ or 4-byte WRITE command can be performed. The HALT command exits either the READ or WRITE commands in their active state. Any other data received when the device is in this state is interpreted as an error and depending on its previous state the NTAG203 returns to the wait, idle or halt state.

8.2.5 Halt state

The halt and idle states constitute the second wait state implemented in the NTAG203. An already processed NTAG203 can be set into the halt state using the HALT command. In the anticollision phase, this state helps the NFC device to distinguish between processed cards and cards yet to be selected. The NTAG203 can only exit this state on execution of the WUPA command. Any other data received when the device is in this state is interpreted as an error and the NTAG203 state is unchanged. Refer to the document MIFARE collection of currently available application notes for correct implementation of an anticollision procedure based on the idle and halt states and the REQA and WUPA commands.

8.3 Data integrity

The following mechanisms are implemented in the contactless communication link between NFC device and NTAG203 to ensure a reliable data transmission:

- 16 bits CRC per block
- Parity bit for each byte
- Bit count checking
- Bit coding to distinguish between "1", "0", and no information
- Channel monitoring (protocol sequence and bit stream analysis)

8.4 RF interface

The RF-interface is according to the standard for contactless smart cards ISO/IEC 14443A (see [Ref. 1 "ISO/IEC"](#)).

The RF-field from the NFC device is always present (with short modulation pulses when transmitting), because it is used for the power supply of the card.

For both directions of data communication there is one start bit at the beginning of each frame. Each byte is transmitted with a parity bit (odd parity) at the end. The LSBit of the byte with the lowest address of the selected block is transmitted first. The maximum frame length is 164 bits (16 data bytes + 2 CRC bytes = $16 * 9 + 2 * 9 + 1$ start bit + 1 end bit).

8.5 Memory organization

The 168 Bytes of the total memory organized in 42 user memory EEPROM. From that amount, 144 Bytes (36 pages) are available for the user defined data. Each page contains 4 Bytes (32 bits). In the erased state the EEPROM cells are read as a logical “0”, in the written state as a logical “1”.

Table 5. Memory organization

Page address		Byte number			
Decimal	Hex	0	1	2	3
0	00h	serial number			
1	01h	serial number			
2	02h	serial number	internal	lock bytes	lock bytes
3	03h	OTP	OTP	OTP	OTP
4 to 39	04h to 27h	user memory	user memory	user memory	user memory
40	28h	lock bytes	lock bytes	-	-
41	29h	16-bit counter	16-bit counter	-	-

8.5.1 UID/serial number

The unique 7 byte serial number (UID) and its two Block Check Character Bytes (BCC) are programmed into the first 9 bytes of the memory. It therefore covers page 00h, page 01h and the first byte of page 02h. The second byte of page 02h is reserved for internal data. Due to security and system requirements these bytes are write-protected after having been programmed by the IC manufacturer after production.

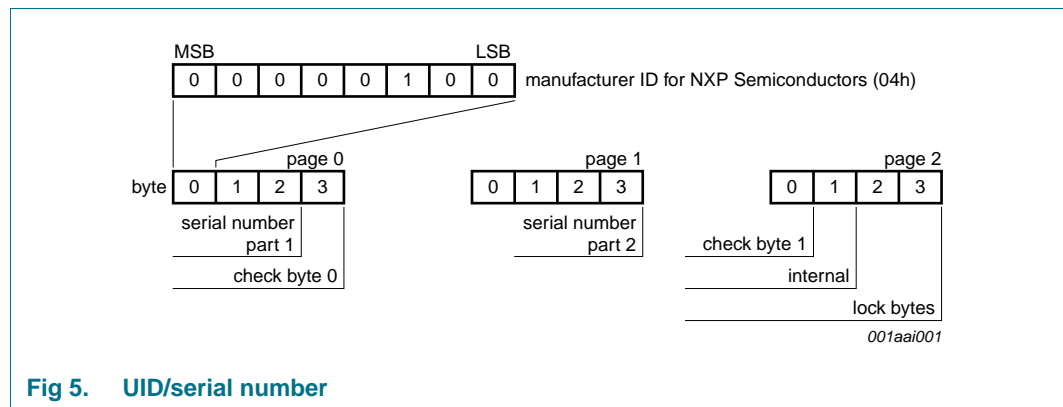

Fig 5. UID/serial number

According to ISO/IEC 14443-3 BCC0 is defined as $CT \oplus SN0 \oplus SN1 \oplus SN2$. Abbreviations CT stays for Cascade Tag byte (88h) and BCC1 is defined as $SN3 \oplus SN4 \oplus SN5 \oplus SN6$.

SN0 holds the Manufacturer ID for NXP (04h) according to ISO/IEC 14443-3 and ISO/IEC 7816-6 AMD.1.

8.5.2 Lock bytes

Lock bytes enable the user to lock parts of the complete memory area for writing. A Read from user memory area cannot be restricted via lock bytes functionality.

The lock bytes functionality is enabled with a WRITE command (see [Section 8.8.7 “WRITE”](#)) or COMPATIBILITY WRITE command (see [Section 8.8.8 “COMPATIBILITY WRITE”](#)), where 2 out of 4 bytes transmitted are used for setting the lock bytes. Two corresponding bytes - either bytes 2 and 3 for page 02h or bytes 0 and 1 for page 28h - and the actual content of the lock bytes are bit-wise “OR-ed”. The result of OR operation becomes the new content of the lock bytes. Two unused bytes do not have to be considered. Although included in the COMPATIBILITY WRITE or WRITE command, they are ignored when programming the memory.

Table 6. Lock bytes

Name	Page		Function
	Number	Address	
Lock byte 0	2	02h	page and block locking
Lock byte 1	2	02h	page locking
Lock byte 2	40	28h	page and block locking
Lock byte 3	40	28h	functionality and block locking

Due to the built-in bitwise OR operation, this process is irreversible. If a bit is set to “1”, it cannot be changed back to “0” again. Therefore, before locking the lock bytes, the user must ensure that the corresponding user memory area and/or configuration bytes are correctly written.

The configuration written in the lock bytes is active upon the next REQA or WUPA command.

The single bits of the 4 bytes available for locking incorporate 3 different functions:

- the read-only locking of the single pages or blocks of the user memory area
- the read-only locking of the single bytes of the configuration memory area
- the locking of the lock bits themselves

For the compatibility reasons, the first 64 bytes (512 bits) of the memory area have the same functionality as MIFARE Ultralight (MF0ICU1, see also [Ref. 7](#)), meaning that the two lock bytes used for the configuration of this memory area are identically configured. The mapping of single bits to memory area for the first 64 bytes (512 bits) is shown in [Figure 6](#).

The bits of byte 2 and 3 of page 02h represent the field-programmable read-only locking mechanism. Each page x from 03h (OTP bits) to 0Fh may be locked individually to prevent further write access by setting the corresponding locking bit L_x to 1. After locking the page is read-only memory.

The 3 least significant bits of lock byte 0 of page 2 are the block-locking bits. Bit 2 handles pages 0Fh to 0Ah, bit 1 pages 09h to 04h and bit 0 page 03h (OTP bits). Once the block locking bits are set, the locking configuration for the corresponding memory area is frozen.

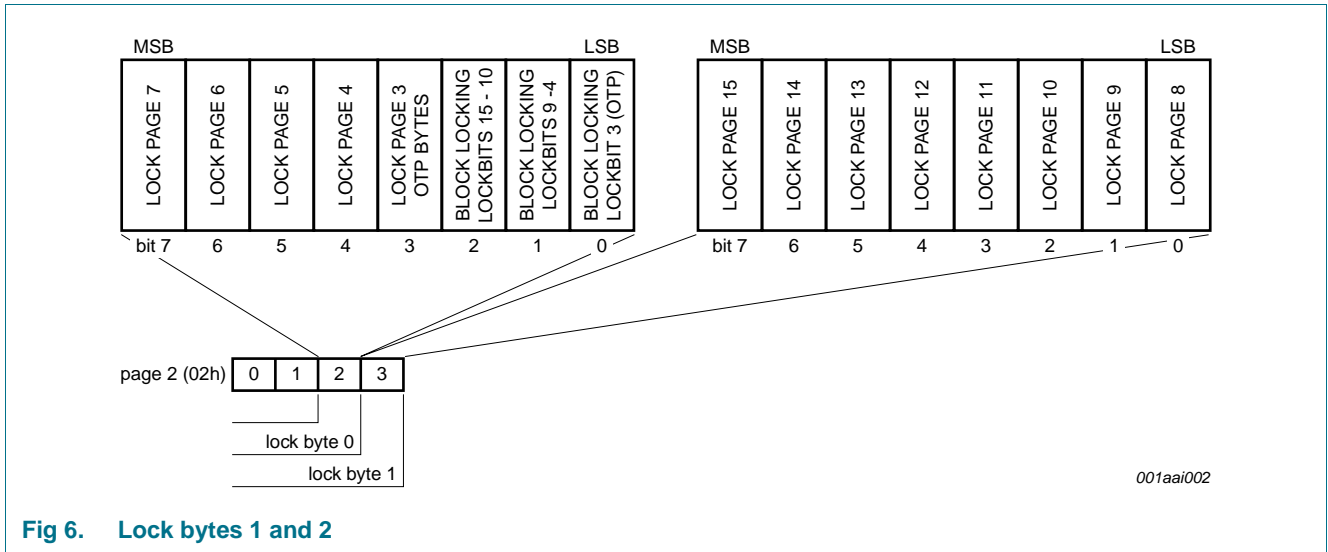

Fig 6. Lock bytes 1 and 2

For locking of pages starting at page address 10h onwards, lock bytes located in page 28h are used. Those two lock bytes cover the memory area of 96 data bytes together with configuration area from page address 28h onwards. Therefore, the granularity is larger than for the first 64 bytes as shown in [Figure 7 “Lock bytes 3 and 4”](#).

The functionality beyond page address 28h which can be locked read-only is:

- the counter
- the lock bytes themselves

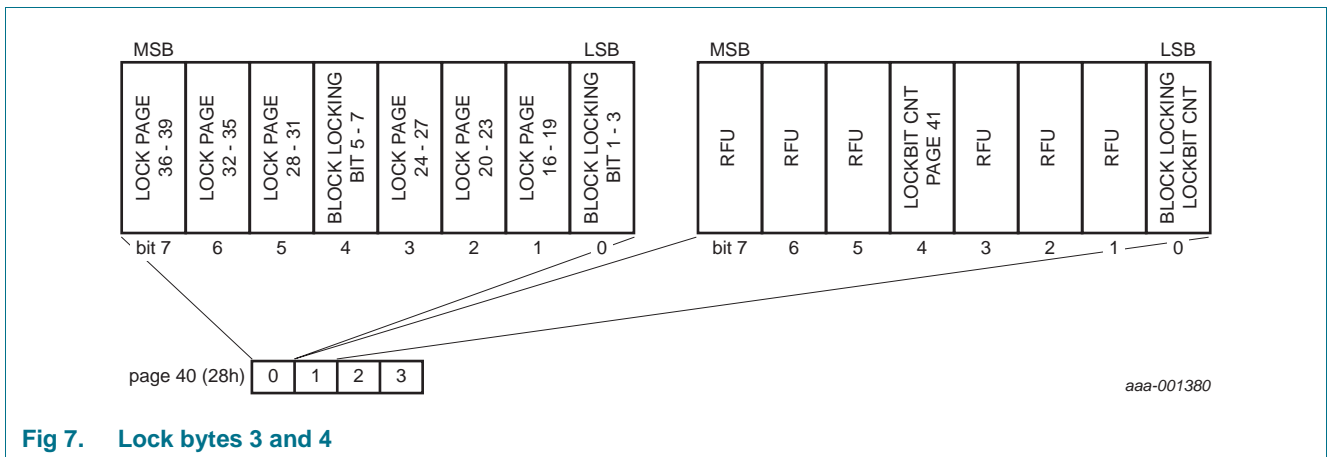
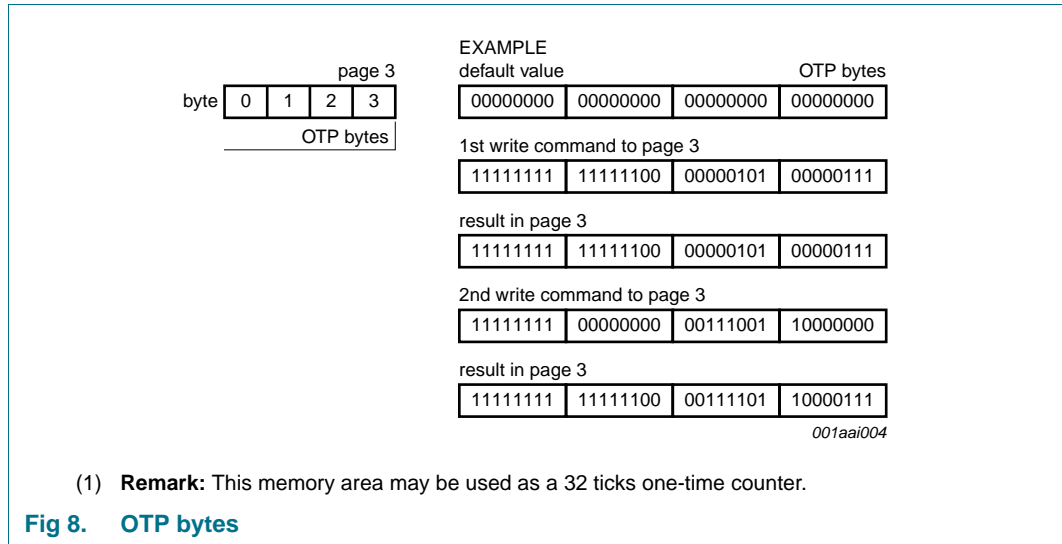

Fig 7. Lock bytes 3 and 4

8.5.3 OTP bytes

Page 3 is the OTP page. It is preset to all “0” after production. These bytes may be bit-wise modified by a WRITE command.



The bytes of the WRITE command and the current contents of the OTP bytes are bit-wise “OR-ed” and the result becomes the new content of the OTP bytes. This process is irreversible. If a bit is set to “1”, it cannot be changed back to “0” again.

8.5.4 Data pages

NTAG203 features 144 bytes of data memory. The address range from page 04h to 27h constitutes the read/write area.

Initial state of each byte in the user area is 00h.

A write access to data memory is achieved with WRITE (see [Section 8.8.7 “WRITE”](#)) or COMPATIBILITY WRITE (see [Section 8.8.8 “COMPATIBILITY WRITE”](#)) command. In both cases, 4 bytes of memory (one page) will be overwritten. Write access to data memory can be permanently restricted via lock bytes (see [Section 8.5.2 “Lock bytes”](#)).

NFC Forum Type 2 Tag compliance

NTAG203 has been designed to be compliant with NFC Forum Type 2 Tag specification (see also [Ref. 5 “Ultralight as Type 2 Tag”](#)). With its 144 bytes of data memory, it can easily support use cases like Smart Poster, Handover, SMS, URL or Call Request.

8.5.5 Initial memory configuration

The memory configuration of NTAG203 in delivery state is shown in [Table 7 “Initial memory organization”](#):

Table 7. Initial memory organization

dec.	Page address		Byte number		
	hex.	0	1	2	3
0	00h	UID0	UID1	UID2	BCC0
1	01h	UID3	UID4	UID5	UID6
2	02h	BCC1	internal	00h	00h
3	03h	E1h	10h	12h	00h
4	04h	01h	03h	A0h	10h
5	05h	44h	03h	00h	FEh
6 to 39	06h to 27h	00h	00h	00h	00h
40	28h	00h	00h	rfu	rfu
41	29h	00h	00h	rfu	rfu

The memory configuration in pages 3 to 5 ensures that NTAG203 is a NFC forum Type 2 Tag in INITIALIZED state according to the NFC Forum Technical Specification, [Ref. 10 “Tag 2 Type Operation, Technical Specification”](#). It is recommended that any further modification of the memory pages 2 to 40 should be according to the [Ref. 10 “Tag 2 Type Operation, Technical Specification”](#).

All lock bytes are set to zero meaning that no page or functionality is locked. Counter is set to zero.

8.6 Counter

NTAG203 features 16-bit one-way counter, located at first two bytes of page 29h. In its delivery state, counter value is set to 0000h.

The first¹ valid Write or Compatibility write to the address 29h can be performed with any value in the range between 0001h and FFFFh and corresponds to initial counter value. Every consequent valid WRITE command, which represents the increment, can contain values between 0001h and 000Fh. Upon such WRITE command and following mandatory RF reset, the value written to the address 29h is added to the counter content.

If - after initial write - a value higher then 000Fh is used as a parameter, NTAG203 will answer with NAK. Once counter value reaches FFFFh and an increment is performed via valid command, NTAG203 will answer with NAK. If the sum of counter value and increment is higher than FFFFh, NTAG203 will answer with NAK and will not update the counter.

Increment by zero (00h) is always possible, but does not have any impact to counter value.

8.7 PICC response to a command from NFC device

NFC Tag Type 2 compliant IC uses, apart from the responses defined in the following sections, two half-byte answers to acknowledge the command received in Active state (see [Figure 4 “Communication principle state diagram - 4-byte; 16-byte”](#)).

NFC Tag Type 2 compliant IC distinguishes between positive (ACK) and negative (NAK) acknowledge. Valid values for ACK and NAK are shown in [Table 8 “ACK and NAK values”](#).

Table 8. ACK and NAK values

Answer value	Answer explanation
Ah	positive acknowledge (ACK)
1h	parity or CRC error (NAK)
0h	any other error (NAK)

After every NAK, NTAG203 will perform an internal reset.

1. First valid write is defined as write to a counter value of zero with an argument different then zero

8.8 Command set

The ATQA and SAK are identical as for MIFARE Ultralight (see [Ref. 7 "MF0ICU1 Functional specification MIFARE Ultralight"](#)). For information on ISO 14443 card activation, see [Ref. 3 "ISO/IEC 14443 PICC Selection"](#). Summary of data relevant for device identification is given in [Section 8.9 "Summary of relevant data for device identification"](#).

The NTAG203 comprises the command set as described in following chapters.

8.8.1 REQA

Table 9. REQA

Code	Parameter	Data	Integrity mechanism	Response
26h (7-bit)	-	-	Parity	0044h

Description: The NTAG203 accepts the REQA command in Idle state only. The response is the 2-byte ATQA (0044h). REQA and ATQA are implemented fully according to ISO/IEC 14443-3.

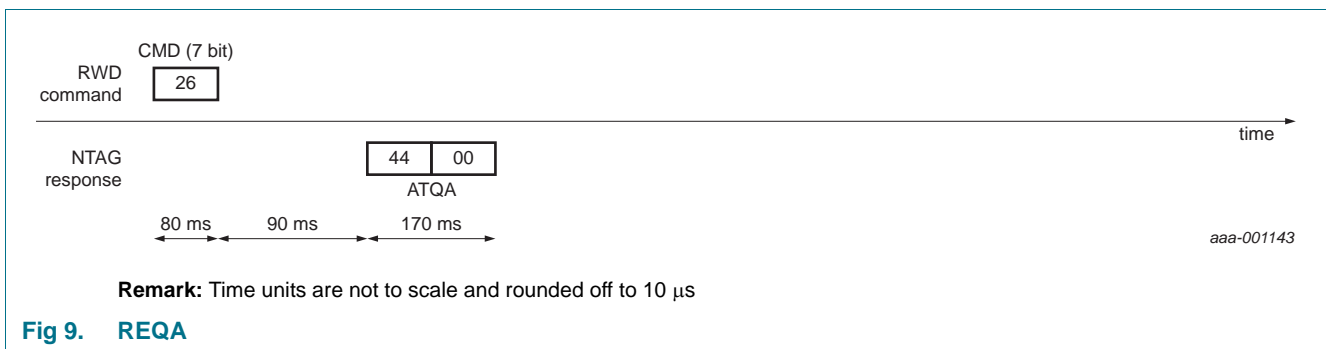

8.8.2 WUPA

Table 10. WUPA

Code	Parameter	Data	Integrity mechanism	Response
52h (7-bit)	-	-	Parity	0044h

Description: NTAG203 accepts the WUPA command in the Idle and Halt state only. The response is the 2-byte ATQA (0044h). WUPA is implemented fully according to ISO/IEC 14443-3.

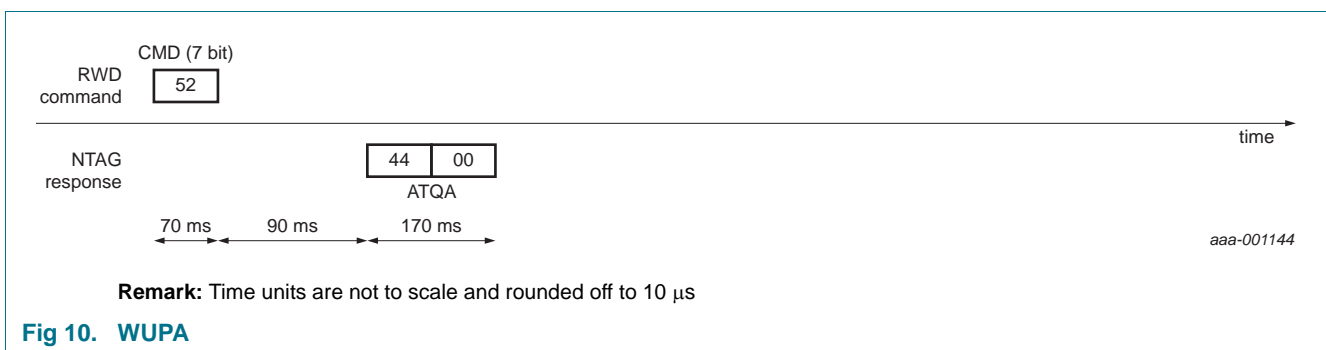

8.8.3 ANTICOLLISION and SELECT of cascade level 1

Table 11. ANTICOLLISION and SELECT of cascade level 1

Code	Parameter	Data	Integrity mechanism	Response
Anticollision: 93h	20h	-	Parity, BCC	-
Anticollision: 93h	21h to 67h	Part of the UID	Parity, BCC	Parts of UID
Select: 93h	70h	First 3 bytes of UID	Parity, BCC, CRC	SAK ('04')

Description: The ANTICOLLISION and SELECT commands are based on the same command code. They differ only in the Parameter byte. This byte is per definition 70h in case of SELECT. NTAG203 accepts these commands in the Ready1 state only. The response is part 1 of the UID. Even with incorrect CRC value, the SELECT command will be fully functional.

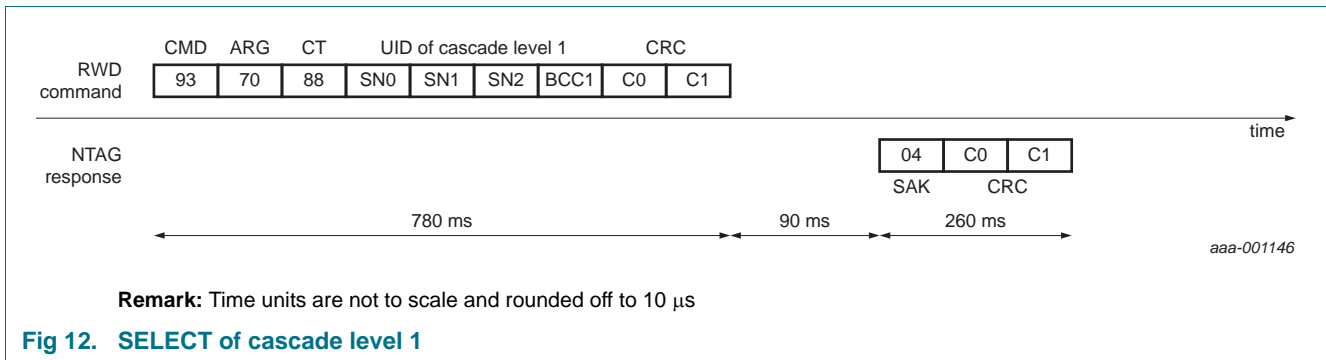
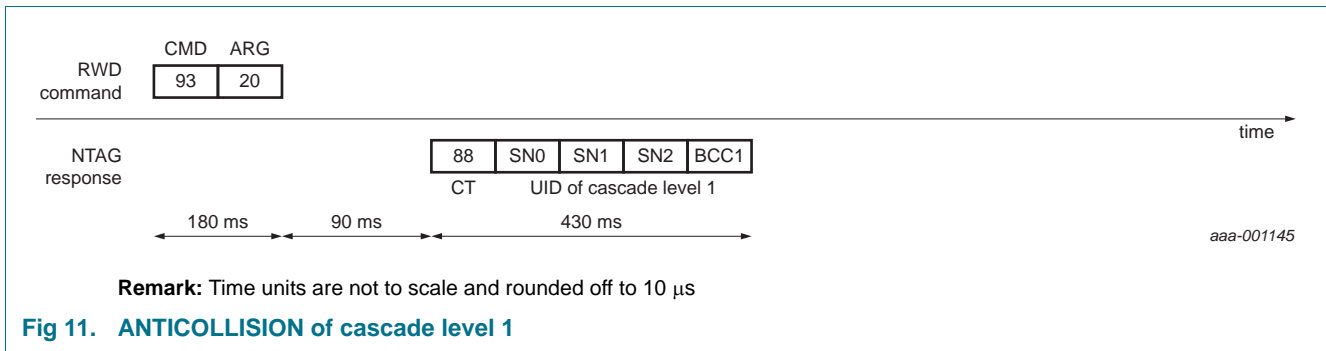

8.8.4 ANTICOLLISION and SELECT of cascade level 2

Table 12. ANTICOLLISION and SELECT of cascade level 2

Code	Parameter	Data	Integrity mechanism	Response
Anticollision: 95h	20h	-	Parity, BCC	-
Anticollision: 95h	21h to 67h	Part of the UID	Parity, BCC	Parts of UID
Select: 95h	70h	Second 4 bytes of UID	Parity, BCC, CRC	SAK ('00')

Description: The ANTICOLLISION and SELECT commands are based on the same command code. They differ only in the parameter byte. This byte is per definition 70h in case of SELECT. NTAG203 accepts these commands in the Ready2 state only. The response is part 2 of the UID. Even with incorrect CRC value, the SELECT command will be fully functional.

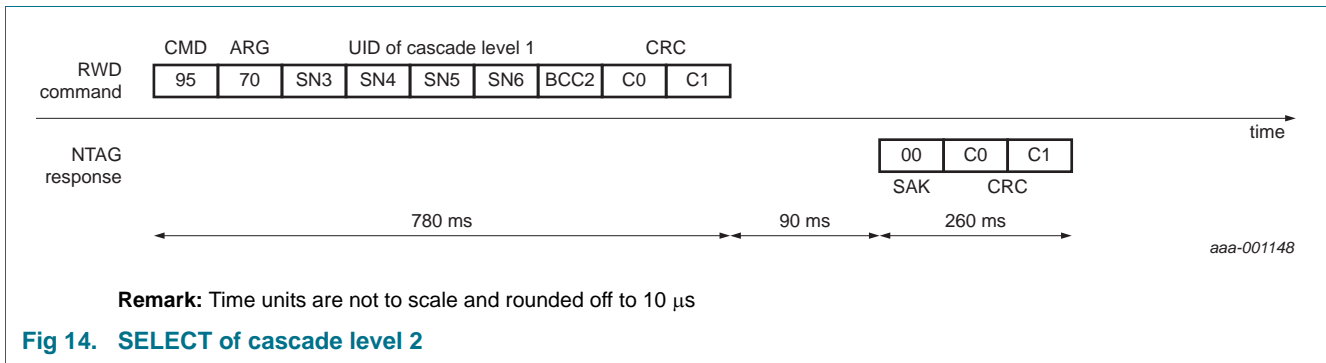
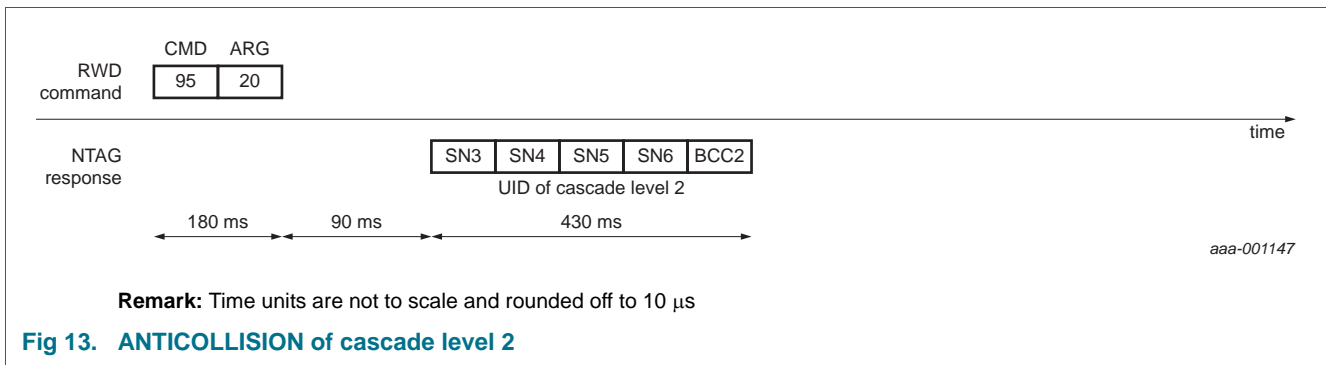

8.8.5 READ

Table 13. READ

Code	Parameter/ARG	Data	Integrity mechanism	Response
30h	ADR: '00h' to '29h'	-	Parity, CRC	16 Byte Date

Description: The READ command needs the page address as a parameter. Only addresses 00h to 29h are decoded. For higher addresses, NTAG203 returns a NAK. The NTAG203 responds to the READ command by sending 16 bytes starting from the page address defined in the command (e.g. if ADR is '03h' pages 03h, 04h, 05h, 06h are returned. If ADR is '29h', the contents of pages 29h, 00h, 01h and 02h is returned).

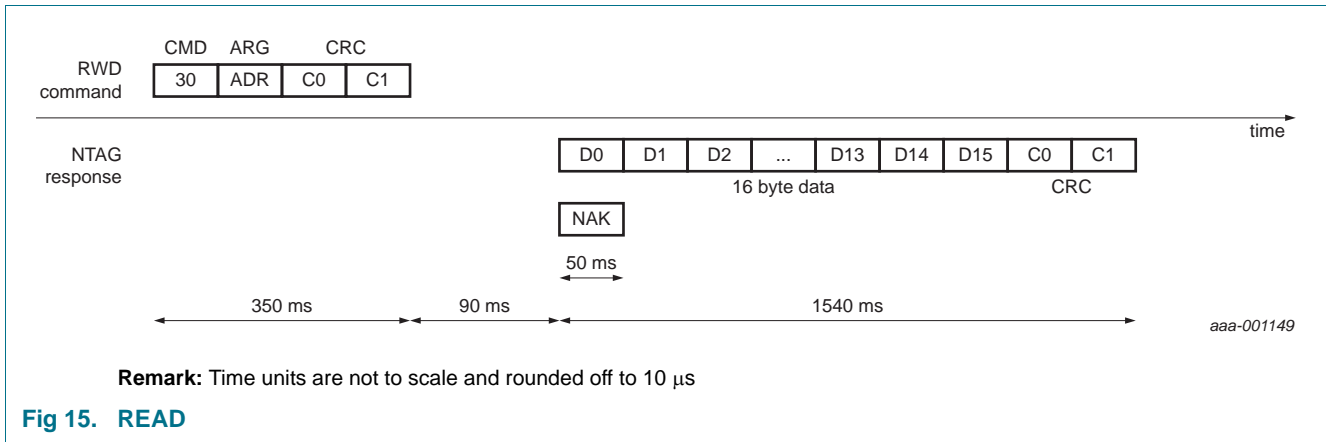

8.8.6 HALT

Table 14. HALT

Code	Parameter	Data	Integrity mechanism	Response
50h	00h	-	Parity, CRC	Passive ACK, NAK

Description: The HALT command is used to set already processed NTAG203 devices into a different waiting state (Halt instead of Idle), which allows a simple separation between devices whose UIDs are already known (as they have already passed the anticollision procedure) and devices that have not yet been identified by their UIDs. This mechanism is a very efficient way of finding all contactless devices in the field of a NFC device. Even with incorrect parity value, the HALT command will be fully functional.

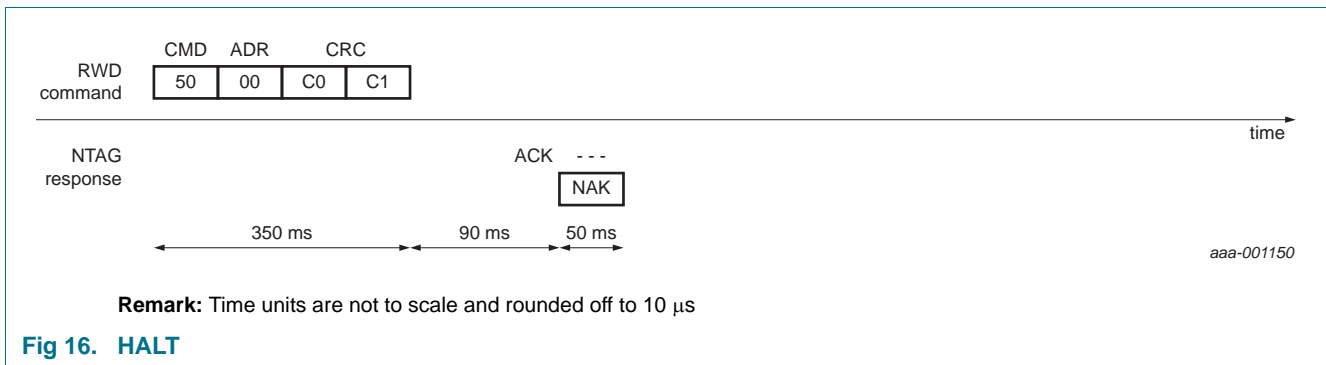

8.8.7 WRITE

Table 15. WRITE

Code	Parameter/ARG	Data	Integrity mechanism	Response
A2h	ADR: '02h' to '29h'	4 Byte	Parity, CRC	ACK or NAK

Description: The WRITE command is used to program the lock bytes in page 02h, the OTP bytes in page 03h or the data bytes in pages 04h to 05h. A WRITE command is performed page-wise, programming 4 bytes in a page.

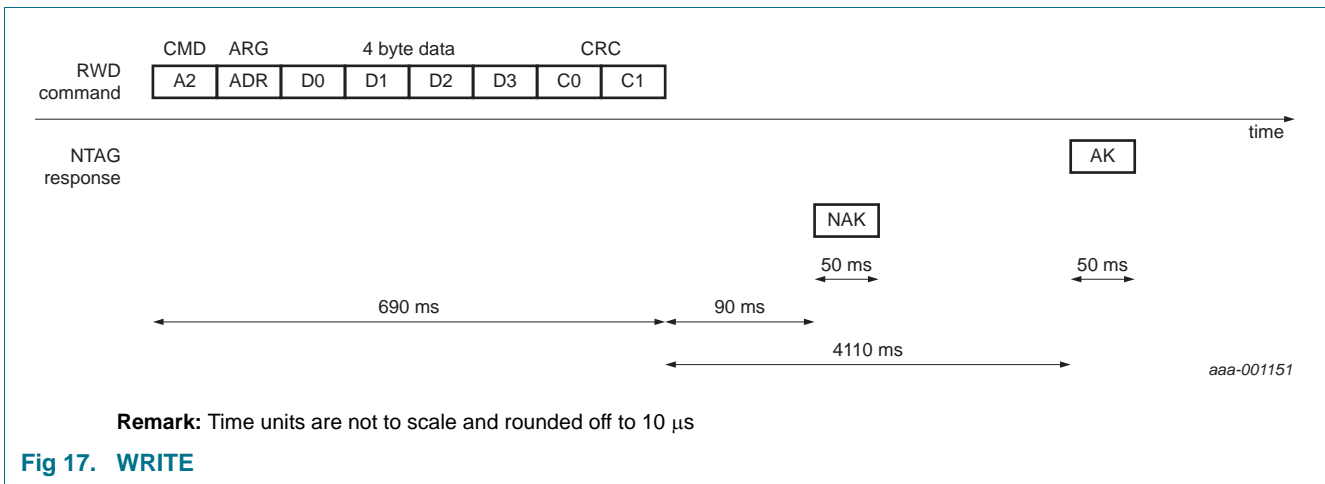

8.8.8 COMPATIBILITY WRITE

Table 16. COMPATIBILITY WRITE

Code	Parameter/ARG	Data	Integrity mechanism	Response
A0h	ADR: '02h' to '29h'	16 Byte	Parity, CRC	ACK or NAK

Description: The COMPATIBILITY WRITE command was implemented to accommodate the established NFC device infrastructure. Even though 16 bytes are transferred to the NTAG203, only the least significant 4 bytes (bytes 0 to 3) will be written to the specified address. It is recommended to set the remaining bytes 4 to 15 to all '0'.

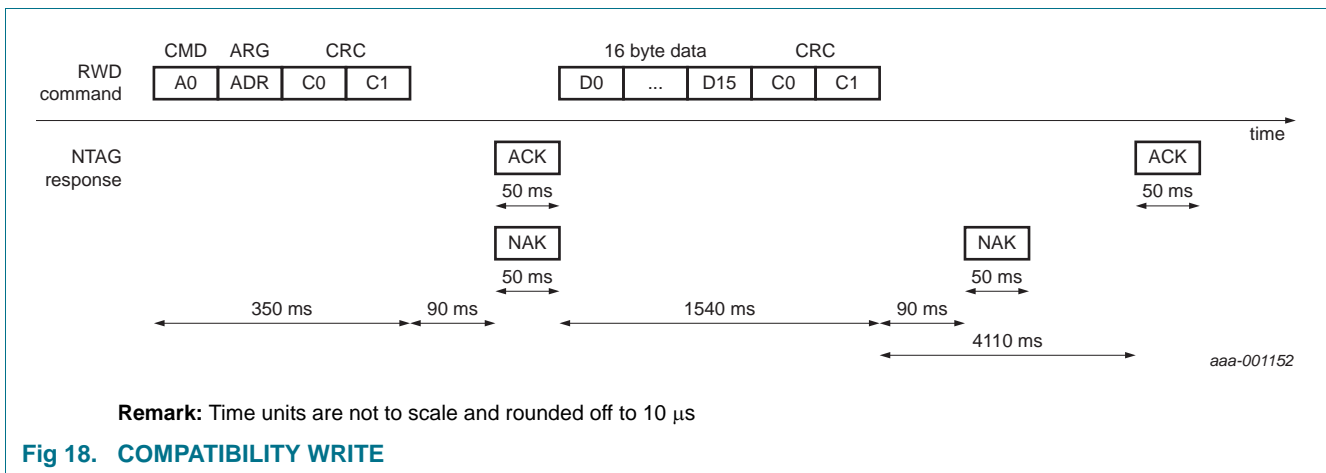

Fig 18. COMPATIBILITY WRITE

8.9 Summary of relevant data for device identification

Table 17. Summary of relevant data for device identification

Code	Type	Value	Binary Format	Remark
ATQA	2 Byte	0044h	0000 0000 0100 0100 1 st '1' indicates cascade level 2 2 nd '1' indicates family	OK
CT	1 Byte Cascade Tag	88h	1000 1000 ensures collision with cascade level 1 products	Hard Coded
SAK (casc. level 1)	1 Byte	04h	0000 0100 '1' indicates additional cascade level	OK
SAK (casc. level 2)	1 Byte	00h	0000 0000 indicates complete UID and NTAG203 functionality	OK
Manufacturer Byte	1 Byte	04h	0000 0100 indicates manufacturer NXP	Acc. to ISO/IEC 14443-3 and ISO/IEC 7816-6 AMD.1

9. Limiting values

Table 18. Limiting values

In accordance with the Absolute Maximum Rating System (IEC 60134).^{[1][2]}

Symbol	Parameter	Conditions	Min	Max	Unit
I_I	input current		-	30	mA
T_{stg}	storage temperature		-55	+125	°C
T_{amb}	ambient temperature		-25	+70	°C
V_{ESD}	electrostatic discharge voltage	measured on pin LA-LB	^[3] 2	-	kV

[1] Stresses above one or more of the limiting values may cause permanent damage to the device.

[2] Exposure to limiting values for extended periods may affect device reliability.

[3] MIL Standard 883-C method 3015; Human body model: C = 100 pF, R = 1.5 kΩ.

10. Characteristics

10.1 Electrical characteristics

Table 19. Characteristics

In accordance with the Absolute Maximum Rating System (IEC 60134).^{[1][2][3]}

Symbol	Parameter	Conditions	Min	Typ	Max	Unit
f_i	input frequency		-	13.56	-	MHz
C_i	input capacitance	50 pF version (bare silicon and HWSO8) ^[4]	44	50	56	pF
EEPROM characteristics						
$t_{cy(W)}$	write cycle time		-	4.1	-	ms
t_{ret}	retention time	$T_{amb} = 22\text{ °C}$	5	-	-	year
$N_{endu(W)}$	write endurance	$T_{amb} = 22\text{ °C}$	10000	-	-	cycle

[1] Stresses above one or more of the limiting values may cause permanent damage to the device.

[2] These are stress ratings only. Operation of the device at these or any other conditions above those given in the Characteristics section of the specification is not implied.

[3] Exposure to limiting values for extended periods may affect device reliability.

[4] LCR meter HP 4285, $T_{amb} = 22\text{ °C}$, Cp-D, $f_i = 13.56\text{ MHz}$, 2Veff.

11. Package outline

This section is not applicable for this device.

12. Abbreviations

Table 20. Abbreviations

Acronym	Description
ACK	positive ACKnowledge
ATQA	Answer To reQuest, type A
BCC	Block Check Characters byte
CBC	Cipher-Block Chaining
CRC	Cyclic Redundancy Check
CT	Cascade Tag, Type A
EEPROM	Electrically Erasable Programmable Read-Only Memory
IV	Initial Value
MSB	Most Significant Bit
NAK	Negative AcKnowledge
LSB	Least Significant Bit
OTP	One Time Programmable
Passive ACK	Implicit acknowledge without PICC answer
PCD	Proximity Coupling Device
PICC	Proximity Integrated Circuit Card
POR	Power On Reset
REQA	ReQuest Answer, type A
RF	Radio Frequency
SAK	Select AcKnowledge, type A
UID	Unique IDentifier
WUPA	Wake-UP command, type A

13. References

- [1] **ISO/IEC** — International Organization for Standardization/International Electrotechnical Commission
- [2] **Interface Platform Type Identification Procedure** — Application note, BL-ID Doc. No.: 0184**2
- [3] **ISO/IEC 14443 PICC Selection** — Application note, BL-ID Doc. No.: 1308**
- [4] **Ultralight Features and Hints** — Application note, BL-ID Doc. No.: 0731**
- [5] **Ultralight as Type 2 Tag** — Application note, BL-ID Doc. No.: 1303**
- [6] **(Card) Coil Design Guide** — Application note, BL-ID Doc. No.: 0117**
- [7] **MF0ICU1 Functional specification MIFARE Ultralight** — Product data sheet, BL-ID Doc. No. 0286**
- [8] **NIST SP800-67: Recommendation for the Triple Data Encryption Algorithm (TDEA) Block Cipher, Version 1.1 May 19, 2008** — National Institute of Standards and Technology

2. ** ... document version number

- [9] **ISO/IEC 10116: Information technology - Security techniques - Modes of operation for an n-bit block cipher, February 1, 2006** — International Organization for Standardization
- [10] **Tag 2 Type Operation, Technical Specification** — NFC Forum, 09.07.2007
- [11] **NFC Data Exchange Format (NDEF), Technical Specification** — NFC Forum, 24.07.2006
- [12] **NXP Semiconductors guidance for soldering the HWSO8 package; URL: [http://www.nxp.com/#/page/content=\[f=/packages/SOT1069-2.xml\]](http://www.nxp.com/#/page/content=[f=/packages/SOT1069-2.xml])** — NXP Semiconductors, 21.08.2009

14. Revision history

Table 21. Revision history

Document ID	Release date	Data sheet status	Change notice	Supersedes
NTAG203 v.3.0	20111017	Product data sheet	-	-

15. Legal information

15.1 Data sheet status

Document status ^{[1][2]}	Product status ^[3]	Definition
Objective [short] data sheet	Development	This document contains data from the objective specification for product development.
Preliminary [short] data sheet	Qualification	This document contains data from the preliminary specification.
Product [short] data sheet	Production	This document contains the product specification.

[1] Please consult the most recently issued document before initiating or completing a design.

[2] The term 'short data sheet' is explained in section "Definitions".

[3] The product status of device(s) described in this document may have changed since this document was published and may differ in case of multiple devices. The latest product status information is available on the Internet at URL <http://www.nxp.com>.

15.2 Definitions

Draft — The document is a draft version only. The content is still under internal review and subject to formal approval, which may result in modifications or additions. NXP Semiconductors does not give any representations or warranties as to the accuracy or completeness of information included herein and shall have no liability for the consequences of use of such information.

Short data sheet — A short data sheet is an extract from a full data sheet with the same product type number(s) and title. A short data sheet is intended for quick reference only and should not be relied upon to contain detailed and full information. For detailed and full information see the relevant full data sheet, which is available on request via the local NXP Semiconductors sales office. In case of any inconsistency or conflict with the short data sheet, the full data sheet shall prevail.

Product specification — The information and data provided in a Product data sheet shall define the specification of the product as agreed between NXP Semiconductors and its customer, unless NXP Semiconductors and customer have explicitly agreed otherwise in writing. In no event however, shall an agreement be valid in which the NXP Semiconductors product is deemed to offer functions and qualities beyond those described in the Product data sheet.

15.3 Disclaimers

Limited warranty and liability — Information in this document is believed to be accurate and reliable. However, NXP Semiconductors does not give any representations or warranties, expressed or implied, as to the accuracy or completeness of such information and shall have no liability for the consequences of use of such information.

In no event shall NXP Semiconductors be liable for any indirect, incidental, punitive, special or consequential damages (including - without limitation - lost profits, lost savings, business interruption, costs related to the removal or replacement of any products or rework charges) whether or not such damages are based on tort (including negligence), warranty, breach of contract or any other legal theory.

Notwithstanding any damages that customer might incur for any reason whatsoever, NXP Semiconductors' aggregate and cumulative liability towards customer for the products described herein shall be limited in accordance with the *Terms and conditions of commercial sale* of NXP Semiconductors.

Right to make changes — NXP Semiconductors reserves the right to make changes to information published in this document, including without limitation specifications and product descriptions, at any time and without notice. This document supersedes and replaces all information supplied prior to the publication hereof.

Suitability for use — NXP Semiconductors products are not designed, authorized or warranted to be suitable for use in life support, life-critical or safety-critical systems or equipment, nor in applications where failure or

malfunction of an NXP Semiconductors product can reasonably be expected to result in personal injury, death or severe property or environmental damage. NXP Semiconductors accepts no liability for inclusion and/or use of NXP Semiconductors products in such equipment or applications and therefore such inclusion and/or use is at the customer's own risk.

Applications — Applications that are described herein for any of these products are for illustrative purposes only. NXP Semiconductors makes no representation or warranty that such applications will be suitable for the specified use without further testing or modification.

Customers are responsible for the design and operation of their applications and products using NXP Semiconductors products, and NXP Semiconductors accepts no liability for any assistance with applications or customer product design. It is customer's sole responsibility to determine whether the NXP Semiconductors product is suitable and fit for the customer's applications and products planned, as well as for the planned application and use of customer's third party customer(s). Customers should provide appropriate design and operating safeguards to minimize the risks associated with their applications and products.

NXP Semiconductors does not accept any liability related to any default, damage, costs or problem which is based on any weakness or default in the customer's applications or products, or the application or use by customer's third party customer(s). Customer is responsible for doing all necessary testing for the customer's applications and products using NXP Semiconductors products in order to avoid a default of the applications and the products or of the application or use by customer's third party customer(s). NXP does not accept any liability in this respect.

Limiting values — Stress above one or more limiting values (as defined in the Absolute Maximum Ratings System of IEC 60134) will cause permanent damage to the device. Limiting values are stress ratings only and (proper) operation of the device at these or any other conditions above those given in the Recommended operating conditions section (if present) or the Characteristics sections of this document is not warranted. Constant or repeated exposure to limiting values will permanently and irreversibly affect the quality and reliability of the device.

Terms and conditions of commercial sale — NXP Semiconductors products are sold subject to the general terms and conditions of commercial sale, as published at <http://www.nxp.com/profile/terms>, unless otherwise agreed in a valid written individual agreement. In case an individual agreement is concluded only the terms and conditions of the respective agreement shall apply. NXP Semiconductors hereby expressly objects to applying the customer's general terms and conditions with regard to the purchase of NXP Semiconductors products by customer.

No offer to sell or license — Nothing in this document may be interpreted or construed as an offer to sell products that is open for acceptance or the grant, conveyance or implication of any license under any copyrights, patents or other industrial or intellectual property rights.

Export control — This document as well as the item(s) described herein may be subject to export control regulations. Export might require a prior authorization from competent authorities.

Quick reference data — The Quick reference data is an extract of the product data given in the Limiting values and Characteristics sections of this document, and as such is not complete, exhaustive or legally binding.

Non-automotive qualified products — Unless this data sheet expressly states that this specific NXP Semiconductors product is automotive qualified, the product is not suitable for automotive use. It is neither qualified nor tested in accordance with automotive testing or application requirements. NXP Semiconductors accepts no liability for inclusion and/or use of non-automotive qualified products in automotive equipment or applications.

In the event that customer uses the product for design-in and use in automotive applications to automotive specifications and standards, customer (a) shall use the product without NXP Semiconductors' warranty of the product for such automotive applications, use and specifications, and (b) whenever customer uses the product for automotive applications beyond NXP Semiconductors' specifications such use shall be solely at customer's own risk, and (c) customer fully indemnifies NXP Semiconductors for any liability, damages or failed product claims resulting from customer design and use of the product for automotive applications beyond NXP Semiconductors' standard warranty and NXP Semiconductors' product specifications.

16. Contact information

For more information, please visit: <http://www.nxp.com>

For sales office addresses, please send an email to: salesaddresses@nxp.com

15.4 Licenses

Purchase of NXP ICs with NFC technology

Purchase of an NXP Semiconductors IC that complies with one of the Near Field Communication (NFC) standards ISO/IEC 18092 and ISO/IEC 21481 does not convey an implied license under any patent right infringed by implementation of any of those standards. A license for the patents portfolio of NXP B.V. for the NFC standards needs to be obtained at Via Licensing, the pool agent of the NFC Patent Pool, e-mail: info@vialicensing.com.

15.5 Trademarks

Notice: All referenced brands, product names, service names and trademarks are the property of their respective owners.

MIFARE — is a trademark of NXP B.V.

MIFARE Ultralight — is a trademark of NXP B.V.

17. Tables

Table 1. Short naming convention (for easier product identification)	2	cascade level 1	17
Table 2. Ordering information	3	Table 12. ANTICOLLISION and SELECT of cascade level 2	18
Table 3. Bonding pad assignments to smart card contactless module	4	Table 13. READ	19
Table 4. Wafer specifications	5	Table 14. HALT	19
Table 5. Memory organization	10	Table 15. WRITE	20
Table 6. Lock bytes	11	Table 16. COMPATIBILITY WRITE	21
Table 7. Initial memory organization	14	Table 17. Summary of relevant data for device identification	22
Table 8. ACK and NAK values	15	Table 18. Limiting values	23
Table 9. REQA	16	Table 19. Characteristics	23
Table 10. WUPA	16	Table 20. Abbreviations	24
Table 11. ANTICOLLISION and SELECT of		Table 21. Revision history	26

18. Figures

Fig 1. NFC Tag interacting with NFC enabled device	1
Fig 2. Block diagram	3
Fig 3. Chip orientation and bond pad locations	4
Fig 4. Communication principle state diagram - 4-byte; 16-byte	7
Fig 5. UID/serial number	10
Fig 6. Lock bytes 1 and 2	12
Fig 7. Lock bytes 3 and 4	12
Fig 8. OTP bytes	13
Fig 9. REQA	16
Fig 10. WUPA	16
Fig 11. ANTICOLLISION of cascade level 1	17
Fig 12. SELECT of cascade level 1	17
Fig 13. ANTICOLLISION of cascade level 2	18
Fig 14. SELECT of cascade level 2	18
Fig 15. READ	19
Fig 16. HALT	19
Fig 17. WRITE	20
Fig 18. COMPATIBILITY WRITE	21

19. Contents

1	General description	1	8.8.8	COMPATIBILITY WRITE	21
1.1	Contactless energy and data transfer	1	8.9	Summary of relevant data for device identification	22
1.2	Naming conventions	2	9	Limiting values	23
2	Features and benefits	2	10	Characteristics	23
2.1	RF Interface (ISO/IEC 14443A)	2	10.1	Electrical characteristics	23
2.2	EEPROM	2	11	Package outline	23
2.3	NFC Forum Tag 2 Type compliance	2	12	Abbreviations	24
2.4	Security	2	13	References	24
2.5	Cascaded UID	3	14	Revision history	26
2.6	Anticollision	3	15	Legal information	27
3	Ordering information	3	15.1	Data sheet status	27
4	Block diagram	3	15.2	Definitions	27
5	Pinning information	3	15.3	Disclaimers	27
5.1	Pin description	3	15.4	Licenses	28
6	Wafer layout	4	15.5	Trademarks	28
7	Mechanical specification	5	16	Contact information	28
7.1	Fail die identification	6	17	Tables	29
8	Functional description	6	18	Figures	29
8.1	Block description	6	19	Contents	30
8.2	State diagram and logical states description	7			
8.2.1	Idle state	8			
8.2.2	Ready1 state	8			
8.2.3	Ready2 state	8			
8.2.4	Active state	8			
8.2.5	Halt state	9			
8.3	Data integrity	9			
8.4	RF interface	9			
8.5	Memory organization	10			
8.5.1	UID/serial number	10			
8.5.2	Lock bytes	11			
8.5.3	OTP bytes	13			
8.5.4	Data pages	13			
8.5.5	Initial memory configuration	14			
8.6	Counter	15			
8.7	PICC response to a command from NFC device	15			
8.8	Command set	16			
8.8.1	REQA	16			
8.8.2	WUPA	16			
8.8.3	ANTICOLLISION and SELECT of cascade level 1	17			
8.8.4	ANTICOLLISION and SELECT of cascade level 2	18			
8.8.5	READ	19			
8.8.6	HALT	19			
8.8.7	WRITE	20			

Please be aware that important notices concerning this document and the product(s) described herein, have been included in section 'Legal information'.

© NXP B.V. 2011.

All rights reserved.

For more information, please visit: <http://www.nxp.com>

For sales office addresses, please send an email to: salesaddresses@nxp.com

Date of release: 17 October 2011
213830

Mouser Electronics

Authorized Distributor

Click to View Pricing, Inventory, Delivery & Lifecycle Information:

[Adafruit:](#)

[4033](#) [4043](#)