

INDUSTRIAL
CINCH

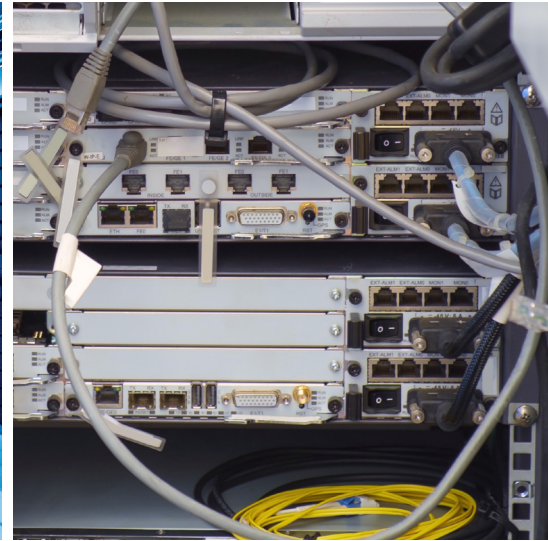

D-Subminiature

Connectors Catalogue

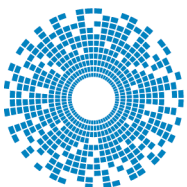

cinch
CONNECTIVITY SOLUTIONS
a bel group

belfuse.com/cinch

About Bel

Bel is a publicly traded company that has been operated by the same family for over 65 years. Our history of organic growth and acquisitions have broadened our product portfolio. This has established Bel as a world leader with a diverse offering of power, protection and interconnect products. We design and manufacture these products which are primarily used in the networking, telecommunications, computing, military, aerospace, transportation and broadcasting industries. Bel's portfolio of products also finds application in the automotive, medical and consumer electronics markets.

About Cinch Connectivity Solutions

For over 100 years, Cinch Connectivity Solutions has manufactured high quality and reliable high performance connectors and cable assemblies. Cinch is recognized as a world class connectivity supplier of RF, fiber optic, hybrid, microwave components, circular, d-subminiatures, modular rectangular, electronic enclosures and cable assemblies. Cinch provides innovative solutions to the military, commercial aerospace, networking, telecommunication, test and measurement, oil and gas and other harsh environment industries. We aim to exceed our customers' expectations and continually offer innovative solutions to the rapidly changing needs of the markets and customers we serve.

Along with our parent company, Bel Fuse Inc., our mission is to provide products and services using established quality standards and to meet our customer expectations. To fulfill this objective, we strive to produce components and assemblies that embody optimum levels of reliability and performance in their design, manufacture, and delivery. Cinch Connectivity Solutions has consistently proven to be a valuable supplier to the foremost companies in its chosen industries by developing cost effective solutions for the challenges of new product development.

About Industrial D-Subminiature Connectors

The D-subminiature is one of the most popular styles of connectors in the I/O category. It is used in computer, telecom, datacom, medical, and test instrumentation applications as well as in the military and aerospace fields.

Types of D-subminiature connectors manufactured by Cinch

Printed Circuit Board connectors:

- Vertical connectors for panel mounting with Dip Solder PC tails.
- Right-Angle connectors for board mounting with Dip Solder PC tails.

Connectors for cable assemblies or wire harnesses:

- Crimp and Poke.
- Solder Cup.
- Insulation Displacement (IDC) to terminate discrete wire.
- Wire Wrap.

Introduction

How to read this section

The information pages provide standard data common to all D-subminiature connectors. These include:

- D-subminiature contact arrangements - see page 4.
- Panel mounting specifications/hardware - see page 5.
- D-subminiature shell dimensions - see page 6.
- PCB thickness chart and PCB layout dimensions - see page 7.

D-subminiature pages are grouped by series. A series is a family of connectors with a similar performance level. Each series shares a set of features and specifications, from economical and commercial grade product to high-reliability and military connectors. Each series begins with a page outlining general features and specifications of connectors, followed by the pages on individual connectors with drawings or features specific to that connector. Drawings reflect clarifications of dimensions not called out in the information pages of this catalog.

Accessories including backshells, junction shells, and hoods as well as hardware can be found on pages 34 thru 50.

Termination tooling for Cinch connectors can be found at the end of the D-subminiature catalog.

General Information

All connectors are intermateable with any Cinch D-subminiature of comparable pin count and density, or the D-sub connector of any other manufacturer complying dimensionally with MIL-C-24308.

Solder terminations and boardlocks meet the requirements for solderability in accordance with MIL-STD-202, Method 208.

DURABILITY

Mated connectors are subjected to cycles of insertions and withdrawals specified on the catalog page. After the prescribed cycles the connectors will meet the Cinch requirements concerning insertion withdrawal force, individual contact insertion-withdrawal force, and contact resistance.

APPROVALS

Most Cinch connectors have UL recognition and CSA approval; however, the specific approvals are listed on the individual catalog pages.

CONTACTS

Cinch connector contacts are generally offered in Gold Flash or 30µin. gold plating for commercial product, and 50µin. gold plating for M24308 Series Military D-subminiature connectors.

Cinch connectors utilize economical stamped and formed contacts and/or screw machine contacts for enhanced performance. Standard density connectors utilize size 20 contacts.

METAL SHELLS

Commercial-grade steel shells are usually available in zinc plating with yellow or clear chromate finish or tin plating.

Tin-plated plugs have grounding indents.

Military grade M24308 Series connector shells are generally steel cadmium plating and yellow chromate finish.

Insulator materials are glass-filled polyester, glass-filled nylon, and diallyl phthalate.

The connectors are usually available in plugs and sockets in 9, 15, 25, 37, and 50 position sizes.

D-SUBMINIATURE CONNECTORS

Introduction

Printed Circuit Board Connectors

Cinch provides connectors in various footprints, contact diameters, and lengths in both vertical and right-angle PC mount styles with dip solder tails.

Cinch PCB connectors have metal shells.

Connectors for Terminating Cable Wire

Wire Wrap connectors are available in two tail lengths for two-wrap and three-wrap terminations. The contact is terminated by wrapping wire around it using a wire wrap gun. This connector is especially useful for prototyping since the wire can be unwrapped and rewrapped if necessary.

Solder Cup connectors allow reliable long-term termination by soldering the wire directly into the connector contact. Cinch Solder Cups accommodate up to 20 AWG wire.

Crimp and Poke connectors allow the wire to be terminated more economically than wire wrap or solder cup styles. Contacts are crimped and inserted into the connector. In our D*U Series, the contact is crimped around the conductor wire. Crimp and Poke connectors can be selectively loaded to save labor and material cost.

Contact Arrangements

Standard Density Plug Inserts

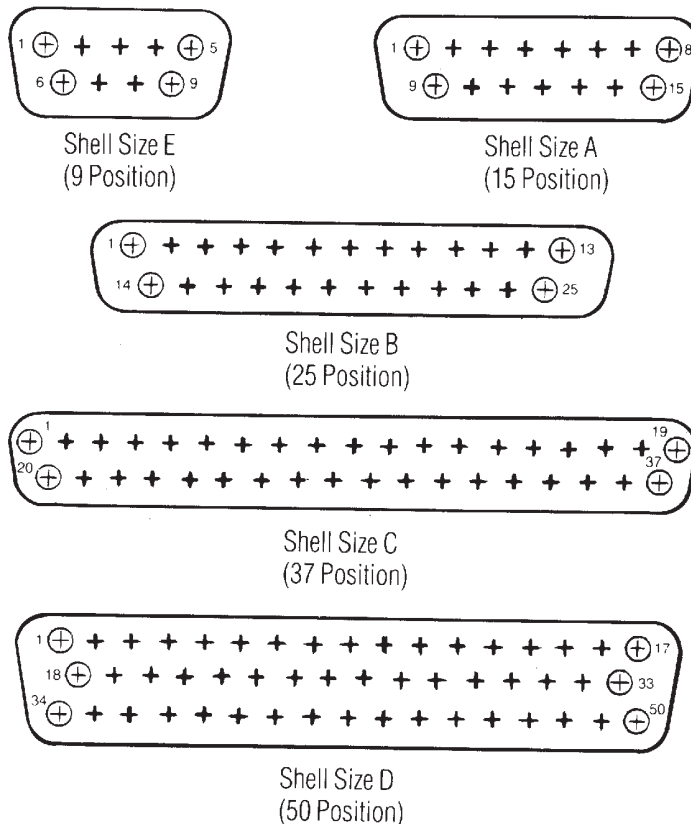

Introduction - Shells and Mounts

Panel Mounting Specifications

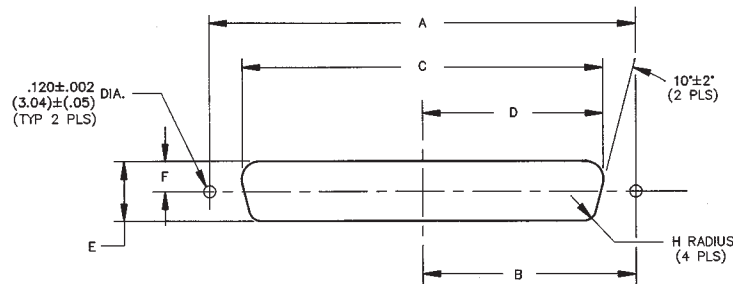

Dimensions

| Mounting Method | | Positions | | A | | B | | C | | D | | E | | F | | H | |
|-----------------|------------------|-----------|-------|------|-------|------|-------|------|-------|------|-------|------|------|------|------|----|----|
| Shell Size | Front/Rear Panel | in | mm | in | mm | in | mm | in | mm | in | mm | in | mm | in | mm | in | mm |
| E | 9 Front | 0.98 | 24.89 | 0.49 | 12.45 | 0.87 | 22.10 | 0.44 | 11.18 | 0.42 | 10.67 | 0.26 | 6.60 | 0.08 | 2.03 | | |
| | 9 Rear | 0.98 | 24.89 | 0.49 | 12.45 | 0.81 | 20.57 | 0.40 | 10.16 | 0.45 | 11.43 | 0.23 | 5.84 | 0.13 | 3.30 | | |
| A | 15 Front | 1.31 | 33.27 | 0.66 | 16.76 | 1.10 | 27.94 | 0.60 | 15.24 | 0.42 | 10.67 | 0.26 | 6.60 | 0.08 | 2.03 | | |
| | 15 Rear | 1.31 | 33.27 | 0.66 | 16.76 | 1.13 | 28.70 | 0.57 | 14.48 | 0.45 | 11.43 | 0.23 | 5.84 | 0.13 | 3.30 | | |
| B | 25 Front | 1.85 | 46.99 | 0.93 | 23.62 | 1.74 | 44.20 | 0.87 | 22.10 | 0.42 | 10.67 | 0.26 | 6.60 | 0.08 | 2.03 | | |
| | 25 Rear | 1.85 | 46.99 | 0.93 | 23.62 | 1.67 | 42.42 | 0.84 | 21.34 | 0.45 | 11.43 | 0.23 | 5.84 | 0.13 | 3.30 | | |
| C | 37 Front | 2.50 | 63.50 | 1.25 | 31.75 | 2.39 | 60.71 | 1.20 | 30.48 | 0.42 | 10.67 | 0.26 | 6.60 | 0.08 | 2.03 | | |
| | 37 Rear | 2.50 | 63.50 | 1.25 | 31.75 | 2.33 | 59.18 | 1.16 | 29.46 | 0.45 | 11.43 | 0.23 | 5.84 | 0.13 | 3.30 | | |
| D | 50 Front | 2.41 | 61.21 | 1.20 | 30.48 | 2.30 | 58.42 | 1.15 | 29.21 | 0.62 | 15.75 | 0.31 | 6.60 | 0.08 | 2.03 | | |
| | 50 Rear | 2.41 | 61.21 | 1.20 | 30.48 | 2.22 | 56.39 | 1.11 | 28.19 | 0.56 | 14.22 | 0.28 | 5.84 | 0.13 | 3.30 | | |

Panel mounting hardware

Aids in alignment of plug and receptacle

Float Bushing

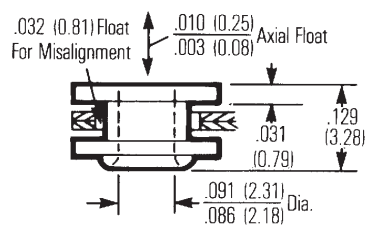

Rear panel mounting

4-40 Clinch Nut

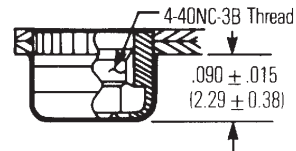

Rear panel mounting

D-SUBMINIATURE CONNECTORS

Introduction - Shells and Mounts

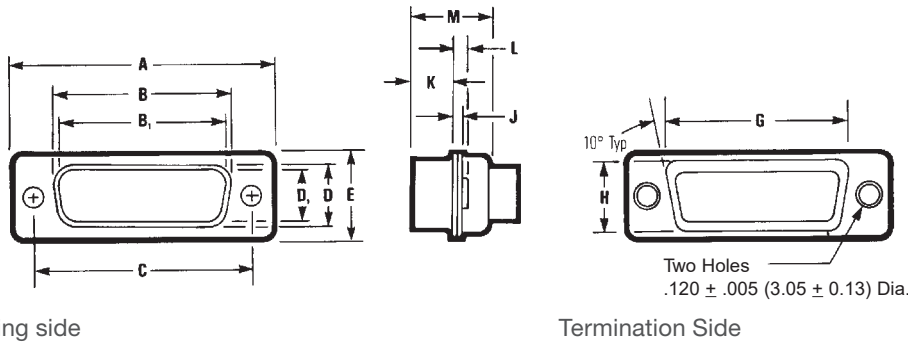

| Shell Size | Positions | Connector Type | A ± .015" (0.38mm) | | B ± .010" (0.25mm) | | B ₁ ± .005" (0.13mm) | | C ± .005" (0.13mm) | | D ± .010" (0.25mm) | | D ₁ ± .010" (0.25mm) | | E ± .010" (0.25mm) | |
|------------|-----------|----------------|--------------------|-------|--------------------|-------|---------------------------------|-------|--------------------|-------|--------------------|-------|---------------------------------|-------|--------------------|-------|
| | | | in | mm | in | mm | in | mm | in | mm | in | mm | in | mm | in | mm |
| E | 9 | Plug | 1.213 | 30.81 | -- | -- | .666 | 16.90 | 0.984 | 24.99 | -- | -- | .329 | 8.40 | .494 | 12.55 |
| | | Socket | 1.213 | 30.81 | .640 | 16.26 | -- | -- | 0.984 | 24.99 | .308 | 7.82 | -- | -- | .494 | 12.55 |
| A | 15 | Plug | 1.541 | 39.14 | -- | -- | .994 | 25.30 | 1.312 | 33.32 | -- | -- | .329 | 8.40 | .494 | 12.55 |
| | | Socket | 1.541 | 39.14 | .968 | 24.59 | -- | -- | 1.312 | 33.32 | .308 | 7.82 | -- | -- | .494 | 12.55 |
| B | 25 | Plug | 2.088 | 53.04 | -- | -- | 1.534 | 39.00 | 1.852 | 47.04 | -- | -- | .329 | 8.40 | .494 | 12.55 |
| | | Socket | 2.088 | 53.04 | 1.508 | 38.30 | -- | -- | 1.852 | 47.04 | .308 | 7.82 | -- | -- | .494 | 12.55 |
| C | 37 | Plug | 2.729 | 69.32 | -- | -- | 2.182 | 55.40 | 2.500 | 63.50 | -- | -- | .329 | 8.40 | .494 | 12.55 |
| | | Socket | 2.729 | 69.32 | 2.156 | 54.76 | -- | -- | 2.500 | 63.50 | .308 | 7.82 | -- | -- | .494 | 12.55 |
| D | 50 | Plug | 2.635 | 66.93 | -- | -- | 2.079 | 52.80 | 2.406 | 61.11 | -- | -- | .436 | 11.07 | .605 | 15.37 |
| | | Socket | 2.635 | 66.93 | 2.062 | 52.34 | -- | -- | 2.406 | 61.11 | .420 | 10.67 | -- | -- | .605 | 15.37 |

| Shell Size | Positions | Connector Type | G ± .010" (0.25mm) | | H ± .010" (0.25mm) | | J ± .010" (0.25mm) | | K ± .005" (0.25mm) | | L ± .010" (0.25mm) | | M ± .010" (0.25mm) | |
|------------|-----------|----------------|--------------------|-------|--------------------|-------|--------------------|------|--------------------|------|--------------------|------|--------------------|-------|
| | | | in | mm | in | mm | in | mm | in | mm | in | mm | in | mm |
| E | 9 | Plug | .759 | 19.28 | .422 | 10.72 | 0.30 | 0.76 | .236 | 5.99 | 0.45 | 1.14 | .422 | 10.72 |
| | | Socket | .759 | 19.28 | .422 | 10.72 | 0.30 | 0.76 | .243 | 6.17 | 0.45 | 1.14 | .429 | 10.92 |
| A | 15 | Plug | 1.083 | 27.51 | .422 | 10.72 | 0.30 | 0.76 | .236 | 5.99 | .045 | 1.14 | .422 | 10.72 |
| | | Socket | 1.083 | 27.51 | .422 | 10.72 | 0.30 | 0.76 | .236 | 6.17 | .045 | 1.14 | .429 | 10.92 |
| B | 25 | Plug | 1.625 | 41.27 | .422 | 10.72 | 0.39 | 0.99 | .231 | 5.87 | .060 | 1.52 | .426 | 10.82 |
| | | Socket | 1.625 | 41.27 | .422 | 10.72 | 0.30 | 0.76 | .243 | 6.17 | .045 | 1.14 | .429 | 10.92 |
| C | 37 | Plug | 2.272 | 57.71 | .422 | 10.72 | 0.39 | 0.99 | .231 | 5.87 | .060 | 1.52 | .426 | 10.82 |
| | | Socket | 2.272 | 57.71 | .422 | 10.72 | 0.30 | 0.76 | .243 | 6.17 | .045 | 1.14 | .429 | 10.92 |
| D | 50 | Plug | 2.178 | 55.32 | .534 | 13.56 | .039 | 0.99 | .231 | 5.87 | .060 | 1.52 | .426 | 10.82 |
| | | Socket | 2.178 | 55.32 | .534 | 13.56 | .030 | 0.76 | .243 | 6.17 | .045 | 1.14 | .429 | 10.92 |

Introduction - Printed Circuit Board Layout Hole Dimensions

Standard Density D-Subminiature Mounting Dimensions Board Layouts Footprints (Component side shown)

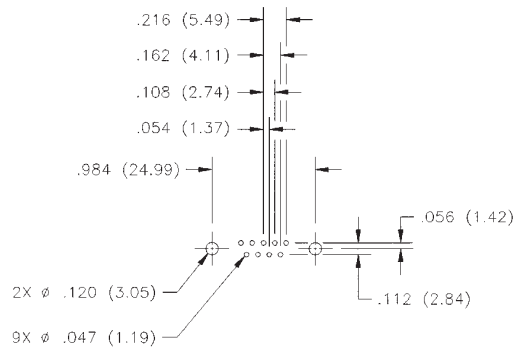

9 Position
Shell Size E

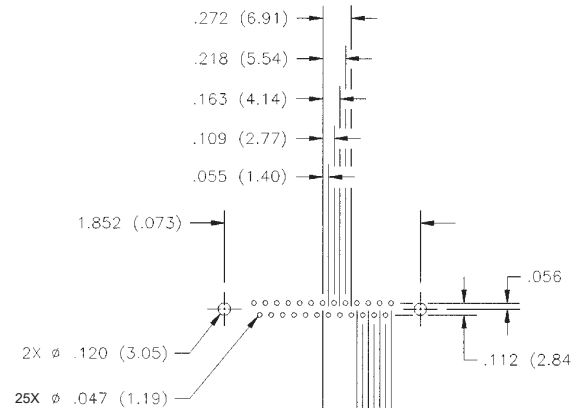

25 Position
Shell Size B

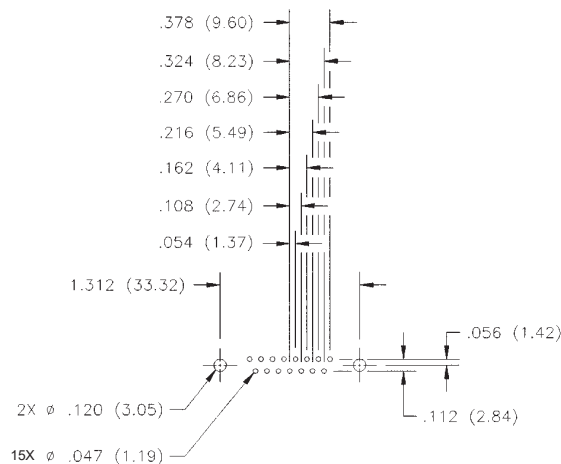

15 Position
Shell Size A

PC Board Lead Hole Size

| Terminal in | Dia. mm | Hole Dia. | |
|----------------|------------|-----------|------|
| | | in | mm |
| .040 | 1.02 | .055 | 1.40 |
| .030 | 0.76 | .045 | 1.14 |
| .024-.025 | 0.61-0.64 | .039 | 0.99 |

The footprints on this page are standard for all metal shell D-subminiature connectors.

On all right-angle D-subminiature connectors, the short row of contacts is positioned closest to the edge of the board.

D-SUBMINIATURE CONNECTORS

Introduction - Printed Circuit Board Layout Hole Dimensions

Standard Density D-Subminiature Mounting Dimensions Board Layouts Footprints (Component side shown)

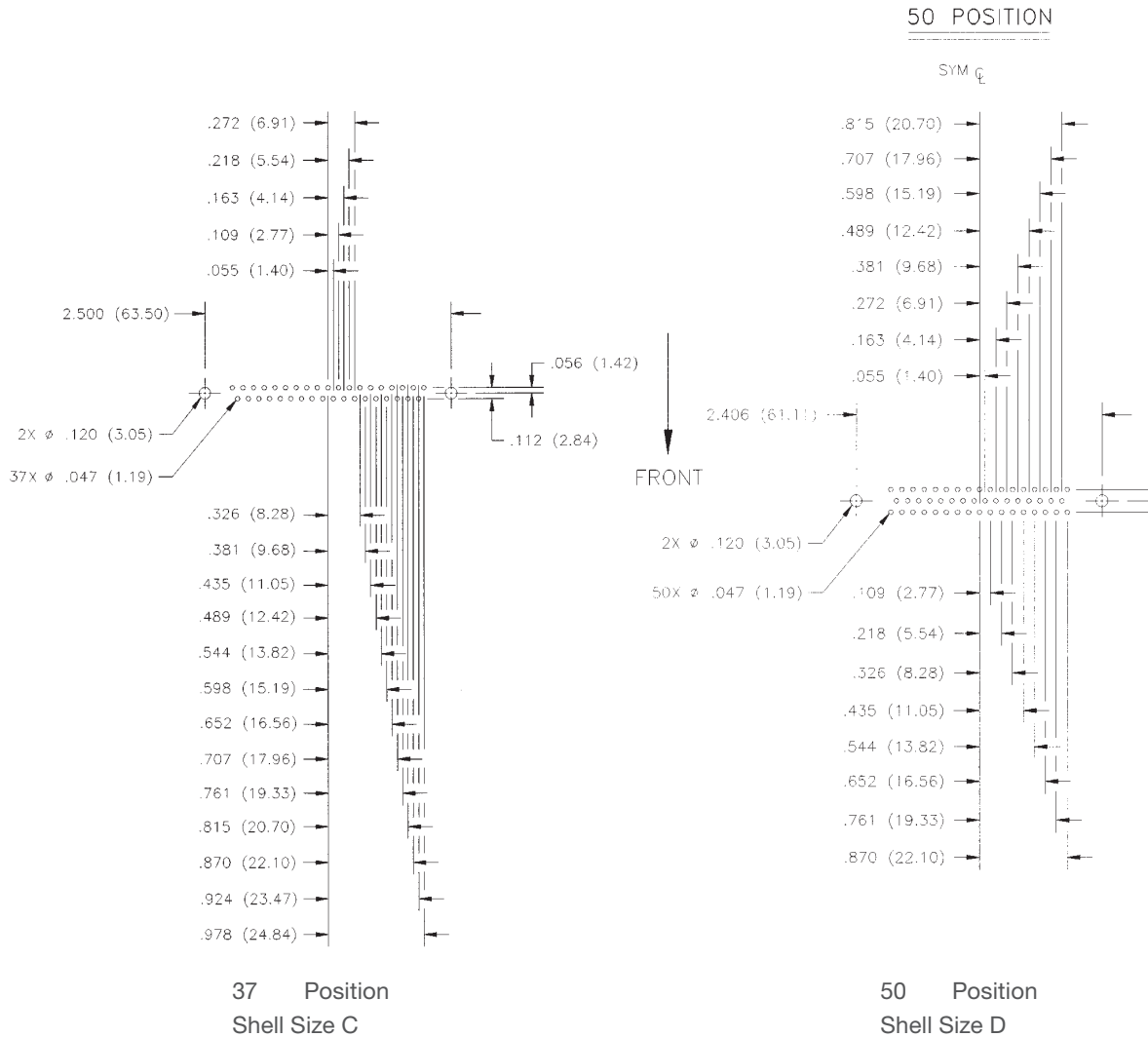

PC Board Lead Hole Size

| Terminal in | Dia. | | Hole Dia. | |
|-------------|-----------|------|-----------|----|
| | mm | in | mm | in |
| .040 | 1.02 | .055 | 1.40 | |
| .030 | 0.76 | .045 | 1.14 | |
| .024-.025 | 0.61-0.64 | .039 | 0.99 | |

The footprints on this page are standard for all metal shell D-subminiature connectors.

On all right-angle D-subminiature connectors, the short row of contacts is positioned closest to the edge of the board.

D-Subminiature Metal Shell Crimp And Poke

Features

- Offered in 9, 15, 25, 37, and 50 position plugs and sockets
- Available with gold flash or 30µin. gold plating.
- Offered with .120 mounting holes, optional 4-40 clinch nuts, or dual float bushings
- Approvals:
- UL Recognized - Files E170218 (UL1977) and E130965 (UL1863).
- CSA Approved - File LR31996.
- See pages 5-6 for standard dimensions, contact arrangements, and panel mounting specifications.

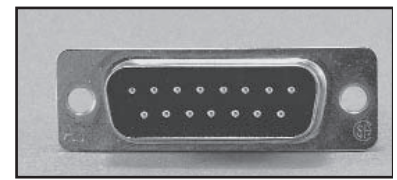
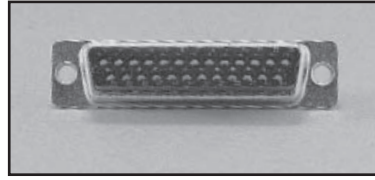
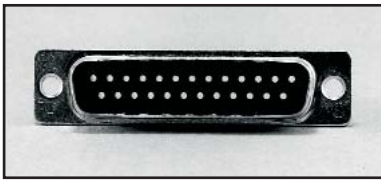

Material Specifications

| | |
|---------------------------|---|
| Insulator Material | Glass-filled nylon (black), UL 94 V-O rated |
| Connector Shell | Steel with zinc plating and yellow chromate finish or clear for RoHS or tin plating (grounding indents on plug) |
| 4-40 Clinch Nut | Steel with cadmium plating and yellow chromate finish |
| Dual Float Bushing | Stainless steel, passivated |

Environmental Specifications

| | |
|------------------------------|---|
| Operating Temperature | -65°C to +105°C |
| Shock | 50G peak per MIL-STD-202, Method 213, Condition G |
| Vibration | 12 cycles in three perpendicular directions @ 10-2000Hz, per MIL-STD-202, Method 204, Condition D |
| Moisture Resistance | 90-95% relative humidity @ 40°C for 96 hours per MIL-STD-202, Method 103 |

Electrical Specifications

| | |
|------------------------------|--|
| Withstanding Voltage | Minimum 1000V RMS @ sea level |
| Current Rating | 5 Amps |
| Contact Resistance | 2.7 milliohms maximum |
| Insulation Resistance | 5000 megohms minimum (initial); 1000 megohms (minimum) after environmental testing |

Mechanical Specifications

| | |
|--|-------------------------------|
| Individual Contact Insertion and Separation Force | 0.7 oz. minimum/12oz. maximum |
| Durability | 500 mating cycles |

D-Subminiature Metal Shell Crimp And Poke D*U Series

Machined contacts supplied loose with connector or can be ordered separately. Use with 20-24 AWG wire.

Materials

| | |
|-------------------------|--|
| Contact Material | Plug - Brass (stamped) or copper alloy (machined). Socket - Phosphor bronze (stamped) copper alloy (machined). |
| Contact Plating | Machined Plugs and Sockets: Golf flash or 30µin. gold. All over nickel |

Termination Tooling

Contact Insertion/Extraction:

- #CIET-20-HDB. See page 51.

Loose Contact Crimp Tool:

- Machined Contact - #M22520/2-01. See page 51.
- For Positioner as required - EP-580. See page 51.

D-SUBMINIATURE CONNECTORS

Ordering Information - D*U Crimp and Poke Plugs

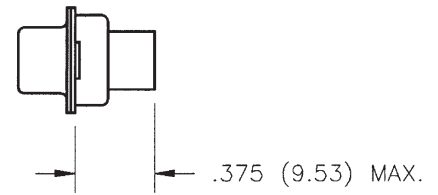

Zinc-Plated Shell with Chromate Finish

| Positions | Yellow Chromate | | | | RoHS Compliant with Clear Chromate | | | |
|-----------|-------------------|------------------|-------------------|------------------|------------------------------------|------------------|-------------------|------------------|
| | Mounting Holes | | 4-40 Clinch Nuts | | Mounting Holes | | 4-40 Clinch Nuts | |
| | Contacts Included | Without Contacts | Contacts Included | Without Contacts | Contacts Included | Without Contacts | Contacts Included | Without Contacts |
| 9 | DEU-9P | DEU-9P-FO | DEUE-9P | DEUE-9P-FO | DEUH-9P | DEUH-9P-FO | DEUEH-9P | DEUEH-9P-FO |
| 15 | DAU-15P | DAU-15P-FO | DAUE-15P | DAUE-15-P-FO | DAUH-15P | DAUH-15P-FO | DAUEH-15P | DAUEH-15P-FO |
| 25 | DBU-25P | DBU-25P-FO | DBUE-25P | DBUE-25P-FO | DBUH-25P | DBUH-25P-FO | DBUEH-25P | DBUEH-25P-FO |
| 37 | DCU-37P | DCU-37P-FO | DCUE-37P | DCUE-37P-FO | DCUH-37P | DCUH-37P-FO | DCUEH-37P | DCUEH-37P-FO |
| 50 | DDU-50P | DDU-50P-FO | DDUE-50P | DDUE-50P-FO | DDUH-50P | DDUH-50P-FO | DDUEH-50P | DDUEH-50P-FO |

Tin-Plated Shell with Grounding Indents

| Positions | Mounting Holes | | 4-40 Clinch Nuts | |
|-----------|-------------------|------------------|-------------------|------------------|
| | Contacts Included | Without Contacts | Contacts Included | Without Contacts |
| 9 | DEU-9PTI | DEU-9PTI-FO | DEUE-9-PTI | DEUE-9PTI-FO |
| 15 | DAU-15PTI | DAU-15PTI-FO | DAUE-15-PTI | DAUE-15PTI-FO |
| 25 | DBU-25PTI | DBU-25PTI-FO | DBUE-25-PTI | DBUE-25PTI-FO |
| 37 | DCU-37PTI | DCU-37PTI-FO | DCUE-37-PTI | DCUE-37PTI-FO |
| 50 | DDU-50PTI | DDU-50PTI-FO | DDUE-50-PTI | DDUE-50PTI-FO |

D*U Crimp and Poke Sockets

| Positions | Yellow Chromate | | | | RoHS Compliant | | | |
|-----------|-------------------|------------------|-------------------|------------------|-------------------|------------------|-------------------|------------------|
| | Mounting Holes | | 4-40 Clinch Nuts | | Mounting Holes | | 4-40 Clinch Nuts | |
| | Contacts Included | Without Contacts | Contacts Included | Without Contacts | Contacts Included | Without Contacts | Contacts Included | Without Contacts |
| 9 | DEU-9S | DEU-9S-FO | DEUE-9S | DEUE-9S-FO | DEUH-9S | DEUH-9S-FO | DEUEH-9S | DEUEH-9S-FO |
| 15 | DAU-15S | DAU-15S-FO | DAUE-15S | DAUE-15S-FO | DAUH-15S | DAUH-15S-FO | DAUEH-15S | DAUEH-15S-FO |
| 25 | DBU-25S | DBU-25S-FO | DBUE-25S | DBUE-25S-FO | DBUH-25S | DBUH-25S-FO | DBUEH-25S | DBUEH-25S-FO |
| 37 | DCU-37S | DCU-37S-FO | DCUE-37S | DCUE-37S-FO | DCUH-37S | DCUH-37S-FO | DCUEH-37S | DCUEH-37S-FO |
| 50 | DDU-50S | DDU-50S-FO | DDUE-50S | DDUE-50S-FO | DDUH-50S | DDUH-50S-FO | DDUEH-50S | DDUEH-50S-FO |

Tin-Plated Shell

| Positions | Mounting Holes | | 4-40 Clinch Nuts | |
|-----------|-------------------|------------------|-------------------|------------------|
| | Contacts Included | Without Contacts | Contacts Included | Without Contacts |
| 9 | DEU-9ST | DEU-9ST-FO | DEUE-9ST | DEUE-9ST-FO |
| 15 | DAU-15ST | DAU-15ST-FO | DAUE-15ST | DAUE-15ST-FO |
| 25 | DBU-25ST | DBU-25ST-FO | DBUE-25ST | DBUE-25ST-FO |
| 37 | DCU-37ST | DCU-37ST-FO | DCUE-37ST | DCUE-37ST-FO |
| 50 | DDU-50ST | DDU-50ST-FO | DDUE-50ST | DDUE-50ST-FO |

D-SUBMINIATURE CONNECTORS

D-Subminiature Metal Shell Crimp And Poke Contacts D*U Series

Machined Contacts • 20-24 AWG Wire

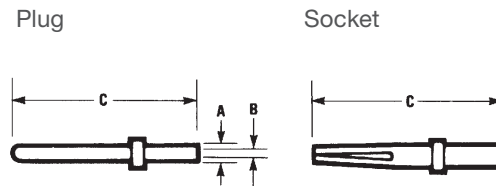

Dimensions

| Description | Wire AWG | A | | B | | C Max. | |
|-------------|-------------|------|------|------|------|--------|-------|
| | | in | mm | in | mm | in | mm |
| Pin | #20, 22, 24 | .066 | 1.67 | .045 | 1.14 | .537 | 13.64 |
| Socket | #20, 22, 24 | .066 | 1.67 | .045 | 1.14 | .523 | 13.28 |

Ordering Information

D*U Series Loose-Piece Machined Contacts

| | Gold Flash | 30µin. Gold |
|--------|--------------|--------------|
| Pin | 030-1952-000 | 030-1952-030 |
| Socket | 030-1953-000 | 030-1953-030 |

D-Subminiature All Plastic Idc T* Series

Features

- Offered in 9, 15, 25, and 37 position plugs and sockets.
- IDC (insulation displacement) terminations for discrete wire.
- Offered with .120 mounting holes.
- Approvals:
 - UL Recognized - Files E170218 (UL1977) and E130965 (UL1863).
 - CSA Approved - File LR31996.
- See pages 5-6 for standard dimensions, contact arrangements, and panel mounting specifications.

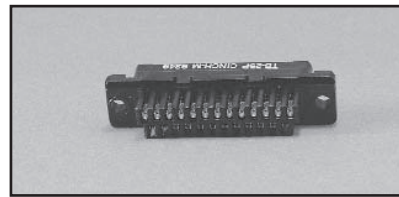
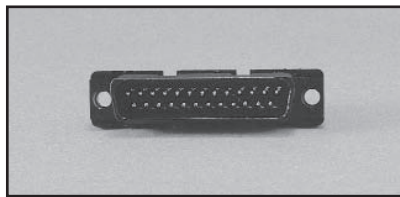

Material Specifications

| | |
|---------------------------|--|
| Insulator Material | Glass-filled polyester (black), UL 94 V-O rated |
| Contact Material | Phosphor bronze (stamped) |
| Contact Plating | Gold flash or 30µin. gold in mating area and gold flash on the remainder. All over nickel. |

Environmental Specifications

| | |
|------------------------------|---|
| Operating Temperature | -65°C to +125°C |
| Shock | 50G peak per MIL-STD-202, Method 213, Condition G |
| Vibration | 12 cycles in three perpendicular directions @ 10-2000Hz, per MIL-STD-202, Method 204, Condition D |
| Moisture Resistance | 90-95% relative humidity @ 40°C for 96 hours per MIL-STD-202, Method 103 |

Electrical Specifications

| | |
|------------------------------|--|
| Withstanding Voltage | Minimum 1000V RMS @ sea level |
| Current Rating | 3 Amps |
| Contact Resistance | 2.7 milliohms maximum |
| Insulation Resistance | 5000 megohms minimum (initial); 1000 megohms (minimum) after environmental testing |

Mechanical Specifications

| | |
|--|-------------------------------|
| Individual Contact Insertion and Separation Force | 0.7 oz. minimum/12oz. maximum |
| Durability | 500 mating cycles |

D-SUBMINIATURE CONNECTORS

D-Subminiature Metal Shell IDC For Discrete Cable Wire T* Series

Optional strain relief covers for connectors when backshell is not required.

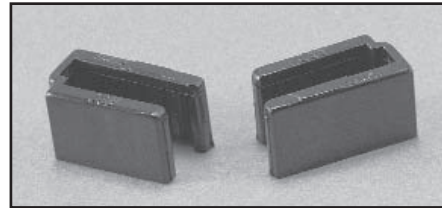
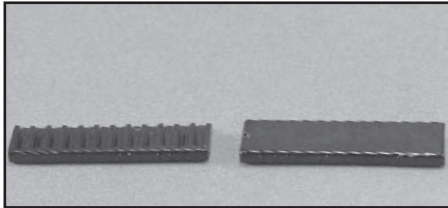

Ordering Information

| Positions | Catalog No. |
|-----------|-------------|
| 9 | SSD-WC9 |
| 15 | SSD-WC15 |
| 25 | SSD-WC25 |
| 37 | SSD-WC37 |

- One-piece cover for 9 contact size. Order one per connector. Two-piece cover for other sizes. Order two per connector.
- Cover fits both plug and socket.

D-Subminiature All-Plastic IDC For Discrete Cable Wire T* Series

- For use only with SDH Series Gray Backshell on page 41.
- Offered in 9, 15, 25, and 37 position plugs and sockets.
- Connector will accommodate 24-28 AWG wire.
- Offered with plain flanges with .120 mounting holes.
- Uni-Clinch D Single-Wire Hand Insertion Tool #SD-UC: See page 50 or 51.
- Super D Manual Stay Band Tool #SD-MSBT: See page 50 or 51.

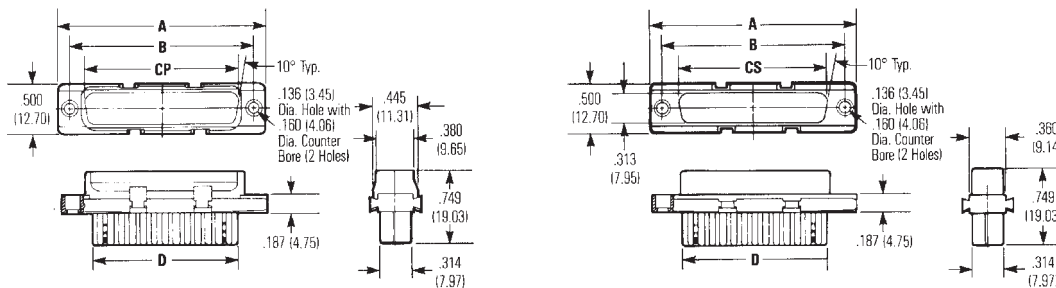

Dimensions

| Positions | A | | A | | B | | CP | | CS | | D | |
|-----------|-------|-------|-------|-------|-------|-------|-------|-------|-------|-------|-------|-------|
| | in | mm | in | mm | in | mm | in | mm | in | mm | in | mm |
| 9 | 1.209 | 30.71 | 1.309 | 33.25 | .984 | 24.99 | .668 | 16.96 | .642 | 16.31 | .592 | 15.04 |
| 15 | 1.536 | 39.01 | 1.636 | 41.55 | 1.312 | 33.32 | .995 | 25.28 | .970 | 24.64 | .918 | 23.31 |
| 25 | 2.079 | 52.81 | 2.179 | 55.35 | 1.852 | 47.04 | 1.535 | 38.99 | 1.512 | 38.40 | 1.462 | 37.13 |
| 37 | 2.724 | 69.19 | 2.824 | 71.73 | 2.500 | 63.50 | 2.183 | 55.45 | 2.158 | 54.81 | 2.114 | 53.70 |

Ordering Information

IDC All-Plastic Plugs Plain Flange

| Positions | RoHS Compliant Mounting Holes | |
|-----------|----------------------------------|------------|
| | Gold Flash | Gold Flash |
| 9 | TE-9P | TEH9P |
| 15 | TA-15P | TAH15P |
| 25 | TB-25P | |

IDC All-Plastic Sockets Plain Flange

| Positions | RoHS Compliant Mounting Holes | |
|-----------|----------------------------------|------------|
| | Gold Flash | Gold Flash |
| 9 | TE-9S | TEH9S |
| 15 | TA-15S | TAH15S |
| 25 | TB-25S | |

D-SUBMINIATURE CONNECTORS

D-Subminiature Metal Shell Solder Cup, Vertical PCB Mount, and Wire Wrap Basic D Series

Features

- Offered in Wire Wrap and Solder Cup styles for wire termination and vertical style for PCB mount.
- Offered with .120 mounting holes, 4-40 clinch nuts, and dual float bushings.
- Offered in 9, 15, 25, 37, and 50 position plugs and sockets.
- Gold flash contacts.
- Approvals:
 - UL Recognized - Files E170218 (UL1977) and E130965 (UL1863).
 - CSA Approved - File LR31996.
- See pages 5-6 for standard dimensions, contact arrangements, and panel mounting specifications.

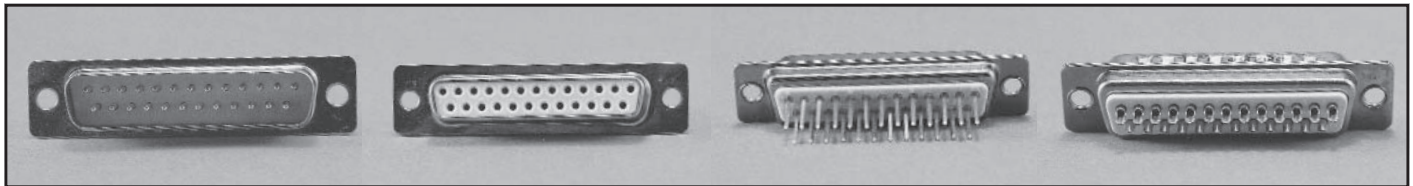

Material Specifications

| | |
|---------------------------|--|
| Insulator Material | Glass-filled polyester (white), UL 94 V-O rated |
| Connector Shell | Steel with zinc plating and yellow chromate finish, RoHS clear chromate or tin plating (grounding indents on plug) |
| 4-40 Clinch Nut | Steel with cadmium plating and yellow chromate finish |
| Dual Float Bushing | Stainless Steel, passivated |

Environmental Specifications

| | |
|------------------------------|---|
| Operating Temperature | -65°C to +125°C |
| Shock | 50G peak per MIL-STD-202, Method 213, Condition G |
| Vibration | 12 cycles in three perpendicular directions @ 10-2000Hz, per MIL-STD-202, Method 204, Condition D |
| Moisture Resistance | 90-95% relative humidity @ 40°C for 96 hours per MIL-STD-202, Method 103 |

Electrical Specifications

| | |
|------------------------------|--|
| Withstanding Voltage | Minimum 1250V RMS @ sea level |
| Current Rating | 5 Amps |
| Contact Resistance | 2.7 milliohms maximum |
| Insulation Resistance | 5000 megohms maximum (initial); 1000 megohms (minimum) after environmental testing |

Mechanical Specifications

| | |
|--|-------------------------------|
| Individual Contact Insertion and Separation Force | 0.7 oz. minimum/12oz. maximum |
| Durability | 500 mating cycles |

D-Subminiature Metal Shell Solder Cup Basic D Series

- Stamped contacts.
- Will accommodate up to 20 AWG wire.

Material Specifications

| | |
|-------------------------|--|
| Contact Material | Copper Alloy |
| Contact Plating | Stamped contacts with gold flash in mating area, gold flash on remainder. All over nickel. |

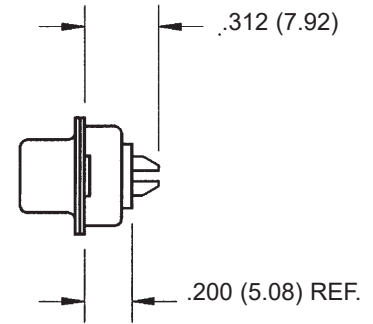

Ordering Information Solder Cup Plugs

Zinc-Plated Shell with Chromate Finish
Stamped Contact with Gold Flash in Solder Cup

| Positions | Yellow Chromate | | RoHS Compliant with Clear Chromate | |
|-----------|-----------------|------------|------------------------------------|------------------|
| | Mounting | Holes | Mounting Holes | 4-40 Clinch Nuts |
| | Gold Flash | Gold Flash | Gold Flash | Gold Flash |
| 9 | DE-9P | DEE-9P | DEH-9P | DEEH-9P |
| 15 | DA-15P | DAE-15P | DAH-15P | DAEH-15P |
| 25 | DB-25P | DBE-25P | DBH-25P | DBEH-25P |
| 37 | DC-37P | DCE-37P | DCH-37P | DCEH-37P |
| 50 | DD-50P | DDE-50P | DDH-50P | DDEH-50P |

Tin-Plated Shell with Ground Indents
Stamped Contact with Gold Flash in Solder Cup

| Positions | Mounting Holes | 4-40 Clinch Nuts | Dual Float Bushings |
|-----------|----------------|------------------|---------------------|
| | Gold Flash | Gold Flash | Gold Flash |
| 9 | DE-9PTI | DEE-9PTI | DEY-9PTI |
| 15 | DA-15PTI | DAE-15PTI | DAY-15PTI |
| 25 | DB-25PTI | DBE-25PTI | DBY-25PTI |
| 37 | DC-37PTI | DCE-37PTI | DCY-37PTI |
| 50 | DD-50PTI | DDE-50PTI | DDY-50PTI |

D-SUBMINIATURE CONNECTORS

D-Subminiature Metal Shell Solder Cup Basic D Series

Ordering Information Solder Cup Sockets

Zinc-Plated Shell with Chromate Finish Stamped Contact with Gold Flash in Solder Cup

| Positions | Yellow Chromate | | | RoHS Compliant with Clear Chromate | | |
|-----------|-----------------|-------------|------|------------------------------------|-------------|------|
| | Mounting Holes | 4-40 Clinch | Nuts | Mounting Holes | 4-40 Clinch | Nuts |
| | Gold Flash | Gold Flash | | Gold Flash | Gold Flash | |
| 9 | DE-9S | DEE-9S | | DEH-9S | DEEH-9S | |
| 15 | DA-15S | DAE-15S | | DAH-15S | DAEH-15S | |
| 25 | DB-25S | DBE-25S | | DBH-25S | DBEH-25S | |
| 37 | DC-37S | DCE-37S | | DCH-37S | DCEH-37S | |
| 50 | DD-50S | DDE-50S | | DDH-50S | DDEH-50S | |

Tin-Plated Shell Stamped Contact with Gold Flash in Solder Cup

| Positions | Mounting Holes | 4-40 Clinch | Nuts |
|-----------|----------------|-------------|------|
| | Gold Flash | Gold Flash | |
| 9 | DE-9ST | DEE-9ST | |
| 15 | DA-15ST | DAE-15ST | |
| 25 | DB-25ST | DBE-25ST | |
| 37 | DC-37ST | DCE-37ST | |
| 50 | DD-50ST | DDE-50ST | |

D-Subminiature Metal Shell Vertical Dip Solder

PCB Basic D Series

- .040" contact diameter.
- Short rear insulator provides low profile on PCB.
- Offered with .120 mounting holes, dual float bushings, or optional 4-40 clinch nuts.

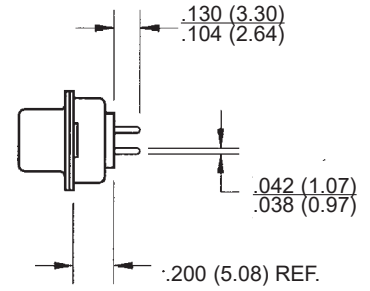

Material Specifications

| | |
|-------------------------|---|
| Contact Material | Socket - Phosphor bronze (machined). Plug - Brass (machined). |
| Contact Plating | Gold flash or 30µin. gold. All over nickel. |

Ordering Information

Vertical PCB Plugs

| Positions | Zinc-Plated Shell with Yellow Chromate Finish | | Tin-Plated Shell with Grounding Indents | |
|-----------|---|------------------|---|------------------|
| | Mounting Holes | 4-40 Clinch Nuts | Mounting Holes | 4-40 Clinch Nuts |
| | Gold Flash | Gold Flash | Gold Flash | Gold Flash |
| 9 | DE-9PV | DEE-9PV | DE-9PVTI | DEE-9PVTI |
| 15 | DA-15PV | DAE-15PV | DA-15PVTI | DAE-15PVTI |
| 25 | DB-25PV | DBE-25PV | DB-25PVTI | DBE-25PVTI |
| 37 | DC-37PV | DCE-37PV | DC-37PVTI | DCE-37PVTI |
| 50 | DD-50PV | DDE-50PV | DD-50PVTI | DDE-50PVTI |

Vertical PCB Sockets

| Positions | Zinc-Plated Shell with Yellow Chromate Finish | | Tin-Plated Shell | |
|-----------|---|------------------|------------------|------------------|
| | Mounting Holes | 4-40 Clinch Nuts | Mounting Holes | 4-40 Clinch Nuts |
| | Gold Flash | Gold Flash | Gold Flash | Gold Flash |
| 9 | DE-9SV | DEE-9SV | DE-9SVT | DEE-9SVT |
| 15 | DA-15SV | DAE-15SV | DA-15SVT | DAE-15SVT |
| 25 | DB-25SV | DBE-25SV | DB-25SVT | DBE-25SVT |
| 37 | DC-37SV | DCE-37SV | DC-37SVT | DCE-37SVT |
| 50 | DD-50SV | DDE-50SV | DD-50SVT | DDE-50SVT |

D-SUBMINIATURE CONNECTORS

D-Subminiature Metal Shell Wire Wrap Basic D Series

- Reliable wire wrap termination.
- Two contact lengths: .375" or .585".
- .025" square contact tails.

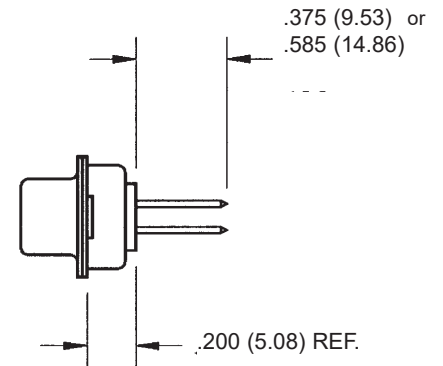

Material Specifications

| | |
|-------------------------|------------------------------|
| Contact Material | Copper alloy (machined). |
| Contact Plating | Gold flash. All over nickel. |

Ordering Information Wire Wrap Plugs .375" Tail Length Zinc-Plated Shell with Chromate Finish

| Positions | Yellow Chromate | | RoHS Compliant with Clear Chromate | |
|-----------|-----------------|------------------|------------------------------------|------------------|
| | Mounting Holes | 4-40 Clinch Nuts | Mounting Holes | 4-40 Clinch Nuts |
| | Gold Flash | Gold Flash | Gold Flash | Gold Flash |
| 9 | DE-9P-F179 | DEE-9P-F179 | DEH-9P-F179 | DEEH-9P-F179 |
| 15 | DA-15P-F179 | DAE-15P-F179 | DAH-15P-F179 | DAEH-15P-F179 |
| 25 | DB-25P-F179 | DBE-25P-F179 | DBH-25P-F179 | DBEH-25P-F179 |
| 37 | DC-37P-F179 | DCE-37P-F179 | DCH-37P-F179 | DCEH-37P-F179 |
| 50 | DD-50P-F179 | DDE-50P-F179 | DDH-50P-F179 | DDEH-50P-F179 |

Tin-Plated Shell with Grounding Indents

| Positions | Mounting Holes | 4-40 Clinch Nuts |
|-----------|----------------|------------------|
| | Gold Flash | Gold Flash |
| 9 | DE-9PTI-F179 | DEE-9PTI-F179 |
| 15 | DA-15PTI-F179 | DAE-15PTI-F179 |
| 25 | DB-25PTI-F179 | DBE-25PTI-F179 |
| 37 | DC-37PTI-F179 | DCE-37PTI-F179 |
| 50 | DD-50PTI-F179 | DDE-50PTI-F179 |

D-Subminiature Metal Shell Wire Wrap Basic D Series

Ordering Information Wire Wrap Plugs .585" Tail Length

Zinc-Plated Shell with Chromate Finish

| Positions | Yellow Chromate | | RoHS Compliant with Clear Chromate | |
|-----------|-----------------|------------------|------------------------------------|------------------|
| | Mounting Holes | 4-40 Clinch Nuts | Mounting Holes | 4-40 Clinch Nuts |
| | Gold Flash | Gold Flash | Gold Flash | Gold Flash |
| 9 | DE-9P-F179C | DEE-9P-F179C | DEH-9P-F179C | DEEH-9P-F179C |
| 15 | DA-15P-F179C | DAE-15P-F179C | DAH-15P-F179C | DAEH-15P-F179C |
| 25 | DB-25P-F179C | DBE-25P-F179C | DBH-25P-F179C | DBEH-25P-F179C |
| 37 | DC-37P-F179C | DCE-37P-F179C | DCH-37P-F179C | DCEH-37P-F179C |
| 50 | DD-50P-F179C | DDE-50P-F179C | DDH-50P-F179C | DDEH-50P-F179C |

Tin-Plated Shell with Grounding Indents

| Positions | Mounting Holes | 4-40 Clinch Nuts |
|-----------|----------------|------------------|
| | Gold Flash | Gold Flash |
| 9 | DE-9PTI-F179C | DEE-9PTI-F179C |
| 15 | DA-15PTI-F179C | DAE-15PTI-F179C |
| 25 | DB-25PTI-F179C | DBE-25PTI-F179C |
| 37 | DC-37PTI-F179C | DCE-37PTI-F179C |
| 50 | DD-50PTI-F179C | DDE-50PTI-F179C |

D-SUBMINIATURE CONNECTORS

D-Subminiature Metal Shell Wire Wrap Basic D Series

Ordering Information

Wire Wrap Sockets .375" Tail Length

Zinc-Plated Shell with Yellow Chromate Finish

| Positions | Yellow Chromate | | RoHS Compliant with Clear Chromate | |
|-----------|-----------------|------------------|------------------------------------|------------------|
| | Mounting Holes | 4-40 Clinch Nuts | Mounting Holes | 4-40 Clinch Nuts |
| | Gold Flash | Gold Flash | Gold Flash | Gold Flash |
| 9 | DE-9S-F179 | DEE-9S-F179 | DEH-9S-F179 | DEEH-9S-F179 |
| 15 | DA-15S-F179 | DAE-15S-F179 | DAH-15S-F179 | DAEH-15S-F179 |
| 25 | DB-25S-F179 | DBE-25S-F179 | DBH-25S-F179 | DBEH-25S-F179 |
| 37 | DC-37S-F179 | DCE-37S-F179 | DCH-37S-F179 | DCEH-37S-F179 |
| 50 | DD-50S-F179 | DDE-50S-F179 | DDH-50S-F179 | DDEH-50S-F179 |

Tin-Plated Shell

| Positions | Mounting Holes | 4-40 Clinch Nuts |
|-----------|----------------|------------------|
| | Gold Flash | Gold Flash |
| 9 | DE-9ST-F179 | DEE-9ST-F179 |
| 15 | DA-15ST-F179 | DAE-15ST-F179 |
| 25 | DB-25ST-F179 | DBE-25ST-F179 |
| 37 | DC-37ST-F179 | DCE-37ST-F179 |
| 50 | DD-50ST-F179 | DDE-50ST-F179 |

Wire Wrap Sockets .585" Tail Length

Zinc-Plated Shell with Chromate Finish

| Positions | Yellow Chromate | | RoHS Compliant with Clear Chromate | |
|-----------|-----------------|------------------|------------------------------------|------------------|
| | Mounting Holes | 4-40 Clinch Nuts | Mounting Holes | 4-40 Clinch Nuts |
| | Gold Flash | Gold Flash | Gold Flash | Gold Flash |
| 9 | DE-9S-F179C | DEE-9S-F179C | DEH-9S-F179C | DEEH-9S-F179C |
| 15 | DA-15S-F179C | DAE-15S-F179C | DAH-15S-F179C | DAEH-15S-F179C |
| 25 | DB-25S-F179C | DBE-25S-F179C | DBH-25S-F179C | DBEH-25S-F179C |
| 37 | DC-37S-F179C | DCE-37S-F179C | DCH-37S-F179C | DCEH-37S-F179C |
| 50 | DD-50S-F179C | DDE-50S-F179C | DDH-50S-F179C | DDEH-50S-F179C |

Tin Plated Shell

| Positions | Mounting Holes | 4-40 Clinch Nuts |
|-----------|----------------|------------------|
| | Gold Flash | Gold Flash |
| 9 | DE-9ST-F179C | DEE-9ST-F179C |
| 15 | DA-15ST-F179C | DAE-15ST-F179C |
| 25 | DB-25ST-F179C | DBE-25ST-F179C |
| 37 | DC-37ST-F179C | DCE-37ST-F179C |
| 50 | DD-50ST-F179C | DDE-50ST-F179C |

D-Subminiature Metal Shell Solder Cup

Series 1 - High Reliability

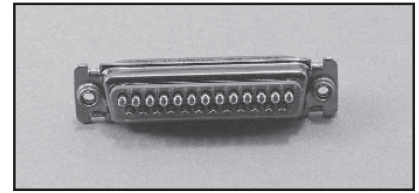

Features

- Solder cup version for wire termination.
- Commercial version of M24308 military connectors with tin-plated or zinc-plated shell and 30µin. gold plating.
- Monoblock green diallyl phthalate insulator for improved electrical performance.
- Machined contacts for precision performance.
- Offered in 9, 15, 25, 37, and 50 position plugs and sockets.
- Offered with .120 mounting holes, 4-40 clinch nuts, or dual float bushings.
- Approvals:
- UL Recognized - Files E170218 (UL1977) and E130965 (UL1863).
- CSA Approved - File LR31996.
- See pages 5-6 for standard dimensions, contact arrangements, and panel mounting specifications.

Material Specifications

| | |
|---------------------------|--|
| Insulator Material | Glass-filled diallyl phthalate (green), UL 94 V-O rated |
| Connector Shell | Steel with zinc plating and yellow chromate finish, RoHS clear chromate or tin plating (grounding indents on plug) |
| Contact Material | Plug - Brass (machined), Socket - Phosphor bronze (machined) |
| Contact Plating | 30µin gold over nickel |
| 4-40 Clinch Nut | Steel with cadmium plating and yellow chromate finish |
| Dual Float Bushing | Stainless Steel, passivated |

Environmental Specifications

| | |
|------------------------------|---|
| Operating Temperature | -65°C to +125°C |
| Shock | 50G peak per MIL-STD-202, Method 213, Condition G |
| Vibration | 12 cycles in three perpendicular directions @ 10-2000Hz, per MIL-STD-202, Method 204, Condition D |
| Moisture Resistance | 90-95% relative humidity @ 40°C for 96 hours per MIL-STD-202, Method 103 |

Electrical Specifications

| | |
|------------------------------|--|
| Withstanding Voltage | Minimum 1250V RMS @ sea level |
| Current Rating | 5 Amps |
| Contact Resistance | 2.7 milliohms maximum |
| Insulation Resistance | 5000 megohms maximum (initial); 1000 megohms (minimum) after environmental testing |

Mechanical Specifications

| | |
|--|-------------------------------|
| Individual Contact Insertion and Separation Force | 0.7 oz. minimum/12oz. maximum |
| Durability | 500 mating cycles |

D-SUBMINIATURE CONNECTORS

D-Subminiature Metal Shell Solder Cup

Series 1 - High Reliability

- Will accommodate up to 20 AWG wire.

Ordering Information Solder Cup Plugs

Zinc-Plated Shell with Chromate Finish

| Positions | Yellow Chromate | | | RoHS Compliant with Clear Chromate | | |
|-----------|----------------------------|----------------------------|------|------------------------------------|----------------------------|------|
| | Mounting Holes | 4-40 Clinch | Nuts | Mounting Holes | 4-40 Clinch | Nuts |
| | 30μ" (microinches) of Gold | 30μ" (microinches) of Gold | | 30μ" (microinches) of Gold | 30μ" (microinches) of Gold | |
| 9 | DEM-9P | DEME-9P | | DEMH-9P | DEMEH-9P | |
| 15 | DAM-15P | DAME-15P | | DAMH-15P | DAMEH-15P | |
| 25 | DBM-25P | DBME-25P | | DBMH-25P | DBMEH-25P | |
| 37 | DCM-37P | DCME-37P | | DCMH-37P | DCMEH-37P | |
| 50 | DDM-50P | DDME-50P | | DDMH-50P | DDMEH-50P | |

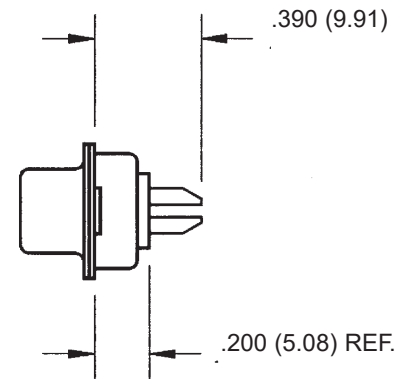

Solder Cup Sockets

Zinc-Plated Shell with Chromate Finish

| Positions | Yellow Chromate | | | RoHS Compliant with Clear Chromate | | |
|-----------|----------------------------|----------------------------|------|------------------------------------|----------------------------|------|
| | Mounting Holes | 4-40 Clinch | Nuts | Mounting Holes | 4-40 Clinch | Nuts |
| | 30μ" (microinches) of Gold | 30μ" (microinches) of Gold | | 30μ" (microinches) of Gold | 30μ" (microinches) of Gold | |
| 9 | DEM-9S | DEME-9S | | DEMH-9S | DEMEH-9S | |
| 15 | DAM-15S | DAME-15S | | DAMH-15S | DAMEH-15S | |
| 25 | DBM-25S | DBME-25S | | DBMH-25S | DBMEH-25S | |
| 37 | DCM-37S | DCME-37S | | DCMH-37S | DCMEH-37S | |
| 50 | DDM-50S | DDME-50S | | DDMH-50S | DDMEH-50S | |

D-Subminiature Metal Shell Crimp And Poke

Series 3 - High Reliability

Features

- High-reliability in a commercial grade connector.
- Monoblock diallyl phthalate insulator for improved electrical performance.
- Offered in 9, 15, 25, 37, and 50 position plugs and sockets.
- Offered with .120 mounting holes and 4-40 clinch nuts.
- Commercial version of M24308 Military connectors with tin-plated or zinc-plated shell and 30µin. gold contact plating.
- Screw Machine Crimp and Poke contacts available as follows:
- Note that all contacts are packed loose.
- Plating options: 30µin. gold.
- Can be included with the connector or purchased separately (FO part numbers).
- See pages 5-6 for standard dimensions, contact arrangements, and panel mounting specifications.

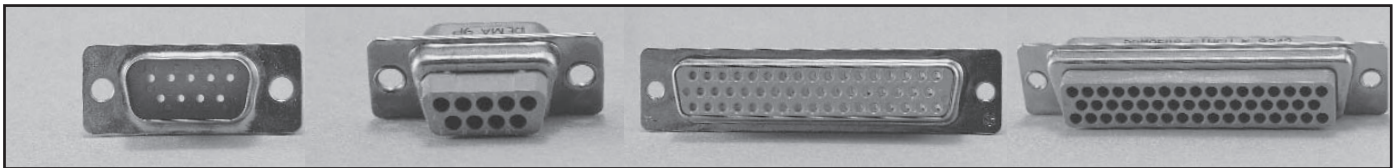

Material Specifications

| | |
|---------------------------|--|
| Insulator Material | Glass fiber-filled diallyl phthalate (green), UL 94 V-O |
| Connector Shell | Steel with zinc plating and yellow chromate finish, clear chromate or tin plated |
| Contact Material | Plug - Brass (machined), Socket - Phosphor bronze (machined) |
| Contact Plating | 30µin gold over nickel |
| 4-40 Clinch Nut | Steel with cadmium plating and yellow chromate finish |
| Dual Float Bushing | Stainless Steel, passivated |

Environmental Specifications

| | |
|------------------------------|---|
| Operating Temperature | -65°C to +125°C |
| Shock | 50G peak per MIL-STD-202, Method 213, Condition G |
| Vibration | 12 cycles in three perpendicular directions @ 10-2000Hz, per MIL-STD-202, Method 204, Condition D |
| Moisture Resistance | 90-95% relative humidity @ 40°C for 96 hours per MIL-STD-202, Method 103 |

Electrical Specifications

| | |
|------------------------------|--|
| Withstanding Voltage | Minimum 1250V RMS @ sea level |
| Current Rating | 5 Amps |
| Contact Resistance | 2.7 milliohms maximum |
| Insulation Resistance | 5000 megohms maximum (initial); 1000 megohms (minimum) after environmental testing |

Mechanical Specifications

| | |
|--|-------------------------------|
| Individual Contact Insertion and Separation Force | 0.7 oz. minimum/12oz. maximum |
| Durability | 500 mating cycles |

D-Subminiature Metal Shell Crimp and Poke

Series 3 - High Reliability

Termination Tooling

- Contact Insertion/Extraction Tool: #CIET-20-HD (Military #M81969/39-01). See p51.
- Crimp Contact Hand Tool: Military #M22520/2-01. See p51. Contact Positioner required.
- Positioner for machine contacts for Hand Tool #M22520/2-01 (locates contact in the correct position): #M22520/2-08. See p51

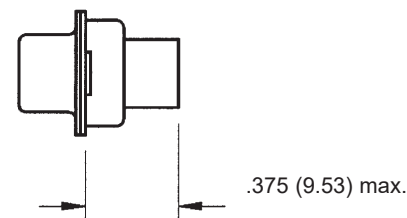

Ordering Information Crimp and Poke - Plugs

Zinc-Plated Shell with Chromate Finish

| Positions | Yellow Chromate | | | | RoHS Compliant with Clear Chromate | |
|-----------|----------------------|------------------|----------------------|------------------|------------------------------------|------------------|
| | Mounting Holes | | 4-40 Clinch Nuts | | Mounting Holes | 4-40 Clinch Nuts |
| | 50µin. Gold Contacts | Without Contacts | 50µin. Gold Contacts | Without Contacts | 50µin. Gold | Without Contacts |
| 9 | DEMA-9P | DEMA-9P-FO | DEMAE-9P | DEMAE-9P-FO | DEMAH-9P | DEMAEH-9P-FO |
| 15 | DAMA-15P | DAMA-15P-FO | DAMAE-15P | DAMAE-15P-FO | DAMAH-15P | DAMAEH-15P-FO |
| 25 | DBMA-25P | DBMA-25P-FO | DBMAE-25P | DBMAE-25P-FO | DBMAH-25P | DBMAEH-25P-FO |
| 37 | DCMA-37P | DCMA-37P-FO | DCMAE-37P | DCMAE-37P-FO | DCMAH-37P | DCMAEH-37P-FO |
| 50 | DDMA-50P | DDMA-50P-FO | DDMAE-50P | DDMAE-50P-FO | DDMAH-50P | DDMAEH-50P-FO |

Tin-Plated Shells with Grounding Indents

| Positions | Mounting Holes | | | 4-40 Clinch Nuts | | |
|-----------|----------------------|------------------|----------|----------------------|------------------|----------|
| | 50µin. Gold Contacts | Without Contacts | Contacts | 50µin. Gold Contacts | Without Contacts | Contacts |
| 9 | DEMA-9PTI | DEMA-9PTI-FO | | DEMAE-9PTI | DEMAE-9PTI-FO | |
| 15 | DAMA-15PTI | DAMA-15PTI-FO | | DAMAE-15PTI | DAMAE-15PTI-FO | |
| 25 | DBMA-25PTI | DBMA-25PTI-FO | | DBMAE-25PTI | DBMAE-25PTI-FO | |
| 37 | DCMA-37PTI | DCMA-37PTI-FO | | DCMAE-37PTI | DCMAE-37PTI-FO | |
| 50 | DDMA-50PTI | DDMA-50PTI-FO | | DDMAE-50PTI | DDMAE-50PTI-FO | |

D-Subminiature Metal Shell Crimp And Poke

Series 3 - High Reliability

Ordering Information Crimp and Poke - Sockets Zinc-Plated Shell with Chromate Finish

| Positions | Yellow Chromate | | | | RoHS Compliant with Clear Chromate | |
|-----------|----------------------|------------------|----------------------|------------------|------------------------------------|------------------|
| | Mounting Holes | | 4-40 Clinch Nuts | | Mounting Holes | 4-40 Clinch Nuts |
| | 50µin. Gold Contacts | Without Contacts | 50µin. Gold Contacts | Without Contacts | 50µin. Gold | Without Contacts |
| 9 | DEMA-9S | DEMA-9S-FO | DEMAE-9S | DEMAE-9S-FO | DEMAH-9S | DEMAEH-9S-FO |
| 15 | DAMA-15S | DAMA-15S-FO | DAMAE-15S | DAMAE-15S-FO | DAMAH-15S | DAMAEH-15S-FO |
| 25 | DBMA-25S | DBMA-25S-FO | DBMAE-25S | DBMAE-25S-FO | DBMAH-25S | DBMAEH-25S-FO |
| 37 | DCMA-37S | DCMA-37S-FO | DCMAE-37S | DCMAE-37S-FO | DCMAH-37S | DCMAEH-37S-FO |
| 50 | DDMA-50S | DDMA-50S-FO | DDMAE-50S | DDMAE-50S-FO | DDMAH-50S | DDMAEH-50S-FO |

Tin-Plated Shell

| Positions | Mounting Holes | | 4-40 Clinch Nuts | |
|-----------|----------------------|------------------|----------------------|------------------|
| | 50µin. Gold Contacts | Without Contacts | 50µin. Gold Contacts | Without Contacts |
| 9 | DEMA-9ST | DEMA-9ST-FO | DEMAE-9ST | DEMAE-9ST-FO |
| 15 | DAMA-15ST | DAMA-15ST-FO | DAMAE-15ST | DAMAE-15ST-FO |
| 25 | DBMA-25ST | DBMA-25ST-FO | DBMAE-25ST | DBMAE-25ST-FO |
| 37 | DCMA-37ST | DCMA-37ST-FO | DCMAE-37ST | DCMAE-37ST-FO |
| 50 | DDMA-50ST | DDMA-50ST-FO | DDMAE-50ST | DDMAE-50ST-FO |

Crimp and Poke Machined Contacts

- Will accommodate 20, 22, and 24 AWG wire.

Ordering Information Contacts

| Description | |
|-------------|---------------|
| Pin | M39029/64-369 |
| Socket | M39029/63-368 |

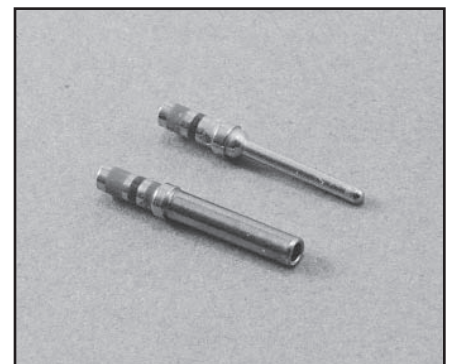

D-SUBMINIATURE CONNECTORS

D-Subminiature Metal Shell MIL-C-24308 M24308 Series

Features

- Meets all MIL-C-24308 Class G specifications.
- Offered in Crimp and Poke and Solder Cup and PCB vertical and right-angle.
- Offered in 9, 15, 25, 37, and 50 position plugs and sockets except right-angle (9 to 37 positions).
- Monoblock green diallyl phthalate insulator for improved electrical performance.
- See pages 4-6 for standard dimensions, contact arrangements, and panel mounting specifications.

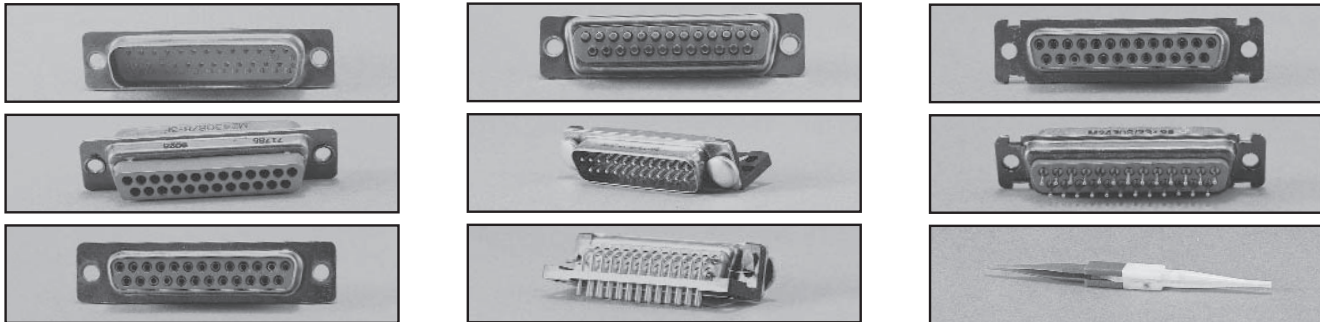

Material Specifications

| | |
|---------------------------|--|
| Insulator Material | Glass-filled diallyl phthalate (green), per MIL-M-14, Type SDG-F |
| Connector Shell | Steel with cadmium plating and yellow chromate finish |
| Contact Material | Plug - Brass (machined), Socket - Phosphor bronze (machined) |
| Contact Plating | 50µin gold over copper or nickel |
| 4-40 Clinch Nut | Steel with cadmium plating and yellow chromate finish |
| Dual Float Bushing | Stainless Steel, passivated or non-magnetic brass |

Environmental Specifications

| | |
|------------------------------|---|
| Operating Temperature | -65°C to +125°C |
| Shock | 50G peak per MIL-STD-202, Method 213, Condition G |
| Vibration | 12 cycles in three perpendicular directions @ 10-2000Hz, per MIL-STD-202, Method 204, Condition D |
| Moisture Resistance | 90-95% relative humidity @ 40°C for 96 hours per MIL-STD-202, Method 103 |

Electrical Specifications

| | |
|------------------------------|--|
| Withstanding Voltage | Minimum 1250V RMS @ sea level |
| Current Rating | 5 Amps |
| Contact Resistance | 2.7 milliohms maximum |
| Insulation Resistance | 5000 megohms maximum (initial); 1000 megohms (minimum) after environmental testing |

Mechanical Specifications

| | |
|--|-------------------------------|
| Individual Contact Insertion and Separation Force | 0.7 oz. minimum/12oz. maximum |
| Durability | 500 mating cycles |

D-Subminiature Metal Shell MIL-C-24308

Crimp And Poke M24308 Series

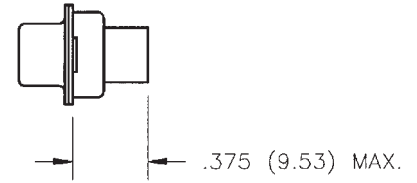

- Available with .120 mounting holes, float bushings, or dual float bushings.
- Order with contacts included or separately.
- Order with contact Insertion/Extraction Tool included or order tool #CIET-20-HD separately. See page 51.

Ordering Information Crimp and Poke Plugs Steel Shell

Contacts Included. Insertion/Extraction Tool Not Included

| Positions | Mounting Holes | Float Bushings | Dual Float Bushings |
|-----------|----------------|----------------|---------------------|
| 9 | M24308/4-1F | M24308/4-302F | M24308/4-435F |
| 15 | M24308/4-2F | M24308/4-303F | M24308/4-436F |
| 25 | M24308/4-3F | M24308/4-304F | M24308/4-437F |
| 37 | M24308/4-4F | M24308/4-305F | M24308/4-438F |
| 50 | M24308/4-5F | M24308/4-306F | M24308/4-439F |

Contacts Included. Insertion/Extraction Tool Included

| Positions | Mounting Holes | Float Bushings | Dual Float Bushings |
|-----------|----------------|----------------|---------------------|
| 9 | M24308/4-6F | M24308/4-313F | M24308/4-446F |
| 15 | M24308/4-7F | M24308/4-314F | M24308/4-447F |
| 25 | M24308/4-8F | M24308/4-315F | M24308/4-448F |
| 37 | M24308/4-9F | M24308/4-316F | M24308/4-449F |
| 50 | M24308/4-10F | M24308/4-317F | M24308/4-450F |

Contacts Not Included. Insertion/Extraction Tool Not Included

| Positions | Mounting Holes | Float Bushings | Dual Float Bushings |
|-----------|----------------|----------------|---------------------|
| 9 | M24308/4-259F | M24308/4-324F | M24308/4-457F |
| 15 | M24308/4-260F | M24308/4-325F | M24308/4-458F |
| 25 | M24308/4-261F | M24308/4-326F | M24308/4-459F |
| 37 | M24308/4-262F | M24308/4-327F | M24308/4-460F |
| 50 | M24308/4-263F | M24308/4-328F | M24308/4-461F |

D-SUBMINIATURE CONNECTORS

D-Subminiature Metal Shell MIL-C-24308

Crimp And Poke M24308 Series

Ordering Information Crimp and Poke Sockets
Steel Shell

Contacts Included. Insertion/Extraction Tool Not Included.

| Positions | Mounting Holes | Float Bushings | Dual Float Bushings |
|-----------|----------------|----------------|---------------------|
| 9 | M24308/2-1F | M24308/2-23F | M24308/2-342F |
| 15 | M24308/2-2F | M24308/2-24F | M24308/2-343F |
| 25 | M24308/2-3F | M24308/2-25F | M24308/2-344F |
| 37 | M24308/2-4F | M24308/2-26F | M24308/2-345F |
| 50 | M24308/2-5F | M24308/2-27F | M24308/2-346F |

Contacts Included. Insertion/Extraction Tool Included.

| Positions | Mounting Holes | Float Bushings | Dual Float Bushings |
|-----------|----------------|----------------|---------------------|
| 9 | M24308/2-6F | M24308/2-34F | M24308/2-353F |
| 15 | M24308/2-7F | M24308/2-35F | M24308/2-354F |
| 25 | M24308/2-8F | M24308/2-36F | M24308/2-355F |
| 37 | M24308/2-9F | M24308/2-37F | M24308/2-356F |
| 50 | M24308/2-10F | M24308/2-38F | M24308/2-357F |

Contacts Not Included. Insertion/Extraction Tool Not Included.

| Positions | Mounting Holes | Float Bushings | Dual Float Bushings |
|-----------|----------------|----------------|---------------------|
| 9 | M24308/2-281F | M24308/2-292F | M24308/2-482F |
| 15 | M24308/2-282F | M24308/2-293F | M24308/2-483F |
| 25 | M24308/2-283F | M24308/2-294F | M24308/2-484F |
| 37 | M24308/2-284F | M24308/2-295F | M24308/2-485F |
| 50 | M24308/2-285F | M24308/2-296F | M24308/2-486F |

D-Subminiature Metal Shell MIL-C-24308

Crimp And Poke M24308 Series

Ordering Information Tooling

- Contact Insertion/Extraction Tool: #CIET-20-HD (Military #M81969/39-01). See page 51.
- Wire termination hand tool: #M22520/2-01. See page 51.
- Positioner for machine contacts for hand tool #M22520/2-08 (locates contact in the correct position). See page 51.

Ordering Information Crimp and Poke Contacts

- Will accommodate 20, 22, and 24 AWG wire.

| | |
|--------------------|---------------|
| Description | |
| Pin | M39029/64-369 |
| Socket | M39029/63-368 |

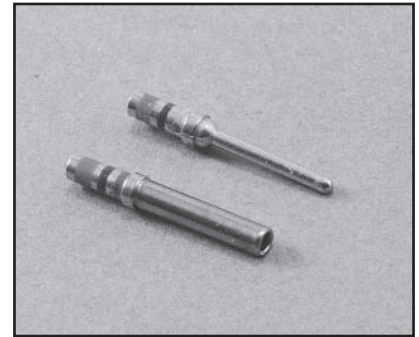

D-Subminiature Metal Shell MIL-C-24308

Solder Cup M24308 Series

- Available with .120" mounting holes, float bushings, or dual float bushings.
- Will accommodate up to 20 AWG wire.

Ordering Information

Solder Cup Plugs - Steel Shell

| Positions | Mounting Holes | Float Bushings | Dual Float Bushings |
|-----------|----------------|----------------|---------------------|
| 9 | M24308/3-1F | M24308/2-12F | M24308/2-17F |
| 15 | M24308/3-2F | M24308/2-13F | M24308/2-18F |
| 25 | M24308/3-3F | M24308/2-14F | M24308/2-19F |
| 37 | M24308/3-4F | M24308/2-15F | M24308/2-20F |
| 50 | M24308/3-5F | M24308/2-16F | M24308/2-21F |

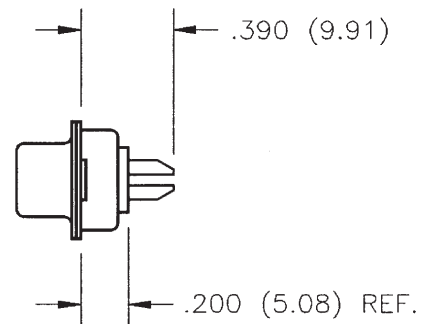

Solder Cup Sockets - Steel Shell

| Positions | Mounting Holes | Float Bushings | Dual Float Bushings |
|-----------|----------------|----------------|---------------------|
| 9 | M24308/1-1F | M24308/1-12F | M24308/1-23F |
| 15 | M24308/1-2F | M24308/1-13F | M24308/1-24F |
| 25 | M24308/1-3F | M24308/1-14F | M24308/1-25F |
| 37 | M24308/1-4F | M24308/1-15F | M24308/1-26F |
| 50 | M24308/1-5F | M24308/1-16F | M24308/1-27F |

D-Subminiature Metal Shell MIL-C-24308 PCB M24308 Series

Ordering Information

- .283" footprint requires minimal PCB space.
- Available with three contact tail lengths (.127" and .183") with .030" contact diameter.
- Offered with .120" mounting holes.
- Mounting bracket: Black nylon. Can be removed if necessary.

Right-Angle

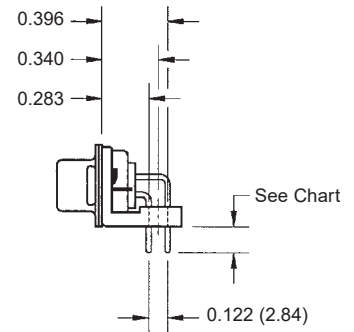

Ordering Information

Right-Angle PCB Plugs (Sockets not available)

Steel Shell

| Positions | .127 Tail Length | .030 Contact Diameter | .183 Tail Length | .030 Contact Diameter |
|-----------|------------------|-----------------------|------------------|-----------------------|
| 9 | | M24308/24-25F | | M24308/24-49F |
| 15 | | M24308/24-26F | | M24308/24-50F |
| 25 | | M24308/24-27F | | M24308/24-51F |
| 37 | | M24308/24-28F | | M24308/24-52F |

Vertical Connector

- Available with two contact tail lengths (.158" and .183") with contact diameter .030".
- Offered with .120" mounting holes.

Vertical

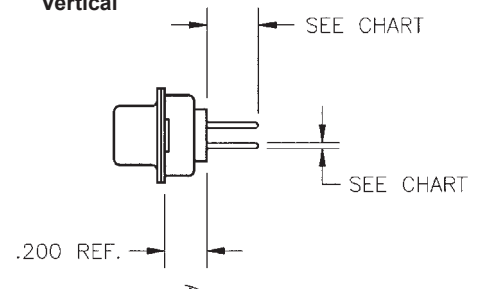

Ordering Information

Vertical PCB Plugs Steel Shell

| Positions | .158 Tail Length | .030 Contact Diameter | .183 Tail Length | .030 Contact Diameter |
|-----------|------------------|-----------------------|------------------|-----------------------|
| 9 | | M24308/24-1F | | M24308/24-7F |
| 15 | | M24308/24-2F | | M24308/24-8F |
| 25 | | M24308/24-3F | | M24308/24-9F |
| 37 | | M24308/24-4F | | M24308/24-10F |
| 50 | | M24308/24-5F | | M24308/24-11F |

Vertical PCB Sockets Steel Shell

| Positions | .158 Tail Length | .030 Contact Diameter | .183 Tail Length | .030 Contact Diameter |
|-----------|------------------|-----------------------|------------------|-----------------------|
| 9 | | M24308/23-1F | | M24308/23-7F |
| 15 | | M24308/23-2F | | M24308/23-8F |
| 25 | | M24308/23-3F | | M24308/23-9F |
| 37 | | M24308/23-4F | | M24308/23-10F |
| 50 | | M24308/23-5F | | M24308/23-11F |

D-Subminiature Backshells / Junction Shells / Hoods Accessories

Features

Cinch backshells are offered in a variety of styles, each having a specific strength.

- Backshells have two-piece construction and are frequently used where appearance is a major factor. RFI/EMI shielding capability is also an option:
 - Plastic Backshells: No shielding.
 - Metallized Plastic: Economical method of shielding.
 - Diecast Backshells: Maximum shielding.
- Cinch SDH Series backshells utilize Cinch's Latch-N-Lock™ system with quick release disconnect. Just squeeze the latch levers to release the connector. Also available with standard 4-40 mounting hardware.
- Junction Shells come in a variety of sizes and shapes including right-angle and low profile. They are generally of one-piece construction with an adjustable clamp, but there is no shielding.
- Hoods have an improved appearance versus junction shells but no shielding. They are all-plastic and come in right-angle or straight configurations.
- Hardware, in the form of adjustable grommets or strain relief clamps and 4-40 screws, is generally supplied with the product; however, a variety of optional hardware is also available in the accessories section of this catalog.

D-Subminiature Backshells - Two-Piece D*H Series

Features

- Standard two-piece construction available in plastic, metallized plastic, or diecast zinc versions with 180° straight cable entry.
- Fits standard metal shell D-subminiature plugs and sockets as well as HTD Series 1.5 D-subs.
- Ethernet hoods are available in diecast 15 position versions only with both 90° and 180° cable entry.
- Included in all backshells:
- Hardware: 4-40 screws, hex nuts, 4-40 screw mounting bracket.
- Grommets: To accommodate most cable sizes. Grommets also function as strain reliefs.
- Backshells are individually bagged.
- Note that slide locks may not be used with these backshells.
- Optional thumbscrew for backshell must be ordered separately if required.

Material Specifications

| | |
|--|---|
| 4-40 screws, hex nuts, mounting bracket | Steel with zinc plating and clear chromate coating |
| Standard Backshells | Plastic Backshells: ABS (black), hardware - steel with zinc plating, grommets - polyphenylene, (black). Metallized Plastic Backshells: ABS with nickel over copper plating, hardware - steel with zinc plating, grommets - PVC (black). Diecast Backshells: Diecast zinc, grommets - PVC (black). |
| Ethernet Backshells | Diecast zinc, grommets - PVC (black) |

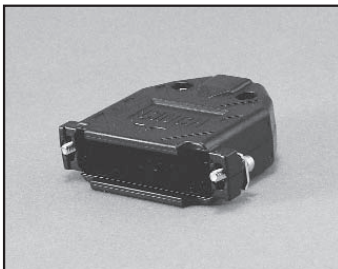

Plastic

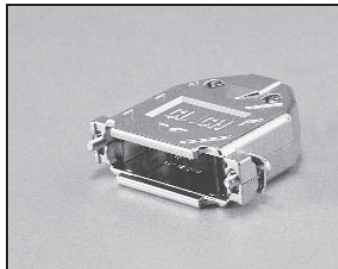

Metallized

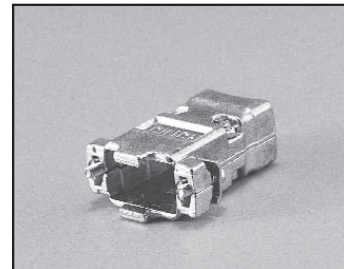

Diecast

D-SUBMINIATURE CONNECTORS

D-Subminiature Backshells - Two-Piece D*H Series

Straight (180°) Standard Backshells
 Plastic and Metallized Plastic Backshells

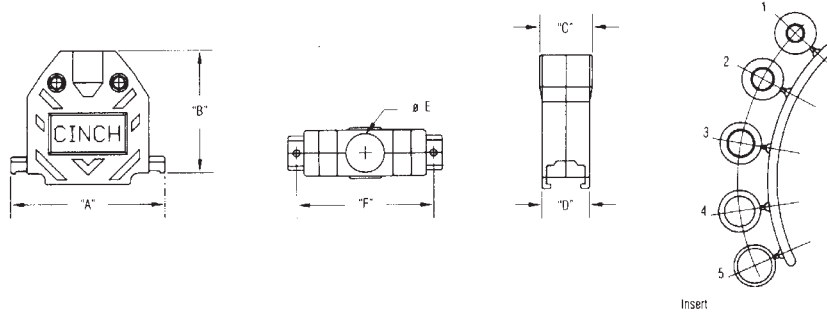

Dimensions

| Shell Size | A | | B | | C | | D | | E | | F | |
|------------|-------|-------|-------|-------|-------|-------|-------|-------|-------|-------|-------|-------|
| | in | mm | in | mm | in | mm | in | mm | in | mm | in | mm |
| E | 1.225 | 31.12 | 1.547 | 39.29 | 0.640 | 16.26 | 0.645 | 16.38 | 0.400 | 10.16 | 0.984 | 24.99 |
| A | 1.540 | 39.12 | 1.516 | 38.51 | 0.640 | 16.26 | 0.645 | 16.38 | 0.400 | 10.16 | 1.312 | 33.32 |
| B | 2.090 | 53.09 | 1.655 | 42.04 | 0.710 | 18.03 | 0.645 | 16.38 | 0.522 | 13.26 | 1.857 | 47.17 |
| C | 2.730 | 69.34 | 1.830 | 46.48 | 0.906 | 23.01 | 0.645 | 16.38 | 0.725 | 18.42 | 2.500 | 63.50 |
| D | 2.645 | 67.18 | 1.855 | 41.12 | 0.940 | 23.88 | 0.750 | 19.05 | 0.725 | 18.42 | 2.406 | 61.11 |

D-Subminiature Backshells - Two-Piece D*H Series

EMI/RFI Shielded Diecast Backshells

9 and 15 Position

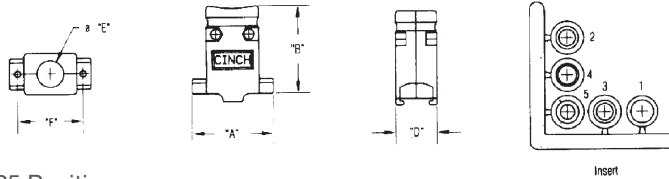

25 Position

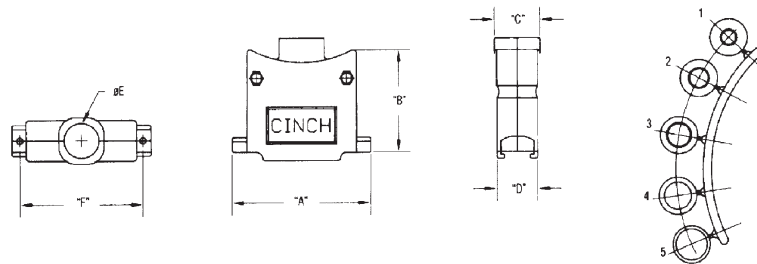

37 and 50 Position

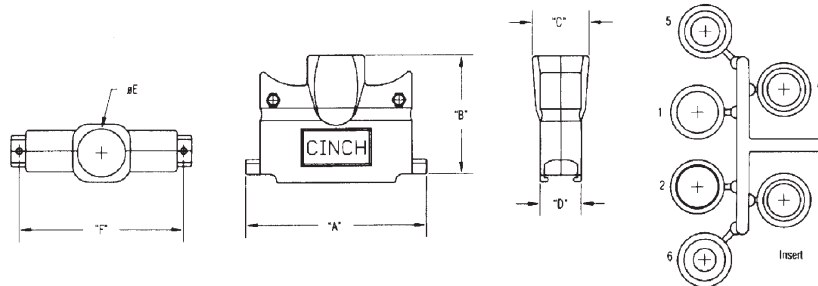

Dimensions

| Shell Size | A | | B | | C | | D | | E | | F | |
|------------|-------|-------|-------|-------|-------|-------|-------|-------|-------|-------|-------|-------|
| | in | mm | in | mm | in | mm | in | mm | in | mm | in | mm |
| E | 1.225 | 31.12 | 1.465 | 37.21 | 0.620 | 15.75 | 0.620 | 15.75 | 0.400 | 10.16 | 0.984 | 24.99 |
| A | 1.540 | 39.12 | 1.600 | 40.64 | 0.620 | 15.75 | 0.620 | 15.75 | 0.400 | 10.16 | 1.312 | 33.32 |
| B | 2.090 | 53.09 | 1.570 | 39.88 | 0.690 | 17.53 | 0.620 | 15.75 | 0.525 | 13.34 | 1.857 | 47.17 |
| C | 2.730 | 69.34 | 1.810 | 45.97 | 0.862 | 21.89 | 0.620 | 15.75 | 0.725 | 18.42 | 2.500 | 63.50 |
| D | 2.624 | 66.65 | 1.800 | 45.72 | 0.862 | 21.89 | 0.730 | 18.54 | 0.725 | 18.42 | 2.406 | 61.11 |

Ordering Information

D*H Two-Piece Backshells

| Shell Size | Fits Standard Density | Cable Entry Style | RoHS Compliant Plastic | Cable Dia. (in) | RoHS Compliant Metallized Plastic | Cable Dia. (in) | Diecast Metal | Cable Dia. (in) |
|------------|-----------------------|-------------------|------------------------|-----------------|-----------------------------------|-----------------|---------------|-----------------|
| E | 9 | Straight (180°) | DPH-E-003 | .210-.320 | DCH-E-003 | .210-.350 | DMH-E-003 | .210-.320 |
| A | 15 | Straight (180°) | | .210-.320 | DCH-A-003 | .210-.350 | DMH-A-003 | .210-.320 |
| B | 25 | Straight (180°) | DPH-B-003 | .230-.450 | DCH-B-003 | .230-.450 | | .230-.450 |
| C | 37 | Straight (180°) | | .350-.650 | DCH-C-003 | .350-.640 | | .350-.650 |

D-Subminiature Backshells - Super D SDH Series

Features

- The Cinch Super D Interconnection System is a simple, fast, economical, and reliable way for mating connectors from cable to cable or cable to panel.
- Snap-on Super D plastic hoods captivate connectors providing positive, self-latching, audible mating with reliable retention and Latch-N-Lock quick release disconnect.
- Snap-on Super-D plastic hoods are also available with filler ends to utilize 4-40 mounting hardware.
- Super D hoods are available:
 - Straight (180°) or Right-Angle (90°) cable entry.
 - Sizes: 9, 15, 25, and 37.
 - Sizes 15, 25, and 37 are available in standard or large cable openings.
- Black SDH backshells accommodate any standard metal shell IDC, solder cup, or crimp and poke D-subminiature connector.
- Gray SDH backshells accommodate the Cinch All-Plastic IDC T-Series connector on page 15.
- Each Super-D plastic hood includes a stay band to strain relief the cable wire. Stay band tool SD-MSBT is required.

Material Specifications

| | |
|-----------------------------------|--|
| Hood | Modified phenylene oxide - black for metal shell connectors or gray for all-plastic IDC connectors |
| Latch Block | Diecast zinc |
| Screws for Latching Blocks | Steel with nickel plating |
| Stay Band | Steel with zinc plating and clear chromate finish |

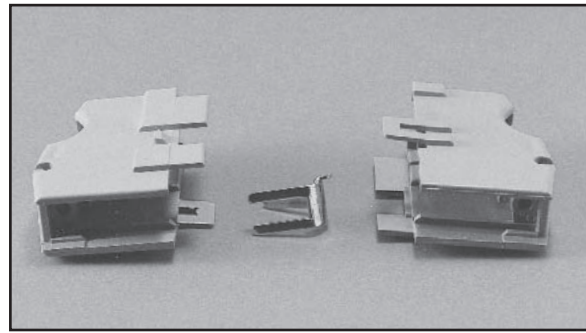
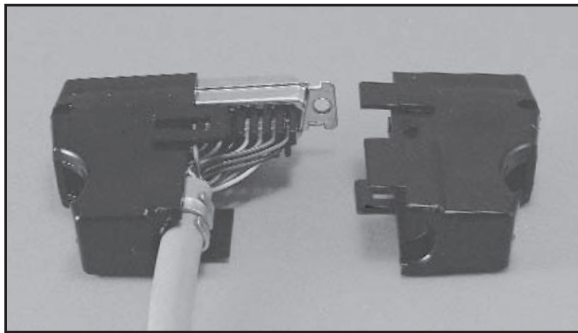

D-Subminiature Backshells - For Use With Metal Shell Connectors SDH Series

Straight (180°) Cable Entry Black Backshells for Metal Shell Connectors

Adapter Hood with Filler Ends

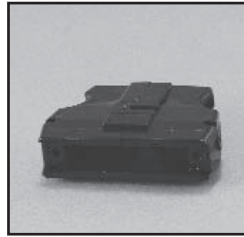
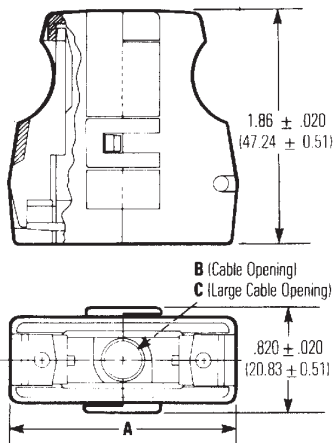

Adapter Hood with Latches

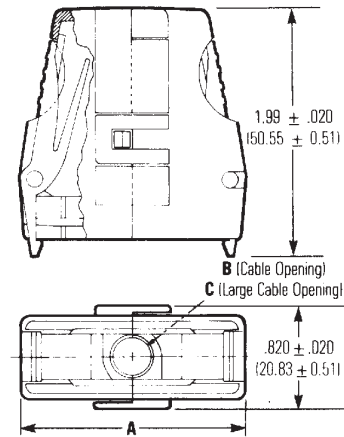

Right-Angle (90°) Cable Entry Black Backshells for Metal Shell Connectors

Right-Angle Adapter Hood

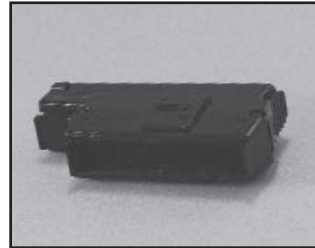
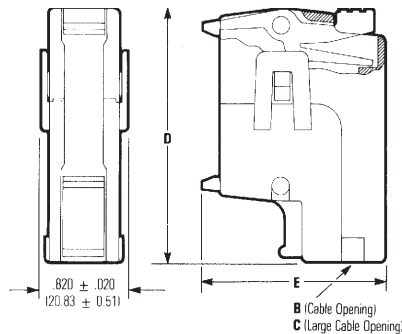

Dimensions

| Positions | A ± .020" (.58mm) | | B ± .020" (.58mm) | | C ± .020" (.58mm) | | D ± .020" (.58mm) | | E ± .020" (.58mm) | |
|-----------|-------------------|-------|-------------------|------|-------------------|-------|-------------------|-------|-------------------|-------|
| | in | mm | in | mm | in | mm | in | mm | in | mm |
| 9 | 1.47 | 37.34 | .31 | 7.87 | - | - | 1.94 | 49.21 | 1.25 | 31.75 |
| 15 | 1.80 | 45.72 | .31 | 7.87 | .41 | 10.41 | 2.25 | 57.15 | 1.34 | 34.13 |
| 25 | 2.35 | 59.69 | .33 | 8.40 | .47 | 11.94 | 2.94 | 74.61 | 1.50 | 38.10 |
| 37 | 2.99 | 75.95 | .37 | 9.40 | .50 | 12.70 | 3.59 | 91.28 | 1.53 | 38.89 |

D-SUBMINIATURE CONNECTORS

D-Subminiature Backshells - For Use With Metal Shell Connectors SDH Series

Ordering Information

Straight (180°) Cable Entry Black Backshells for Metal Shell Connectors

| Positions | (RoHS) Latches Standard Cable Opening |
|-----------|--|
| 9 | SDHH-9BL |
| 15 | SDHH-15BL |
| 25 | SDHH-25BL |

Latching Blocks for Super D Adapter System

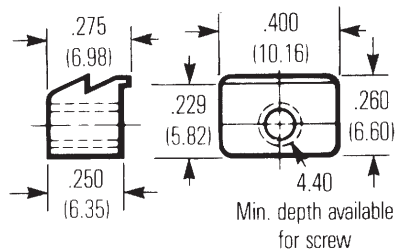

Ordering Information

| Description | For Panel Thickness | Qty per pack | Qty Required Per SDH Hood | Catalog Number |
|--|---------------------|--------------|---------------------------|----------------|
| Latching Block | N/A | 1 each | 2 each | SD-LB |
| Latching Block with SEM Screws | Up to .060" | 2 each | 2 each | SD-LB-060 |
| Removable Mounting Screws for Adapter Hood | N/A | 1 each | 2 each | 4-40UNC2AX3/4 |
| Latching Block with SEM Screws | .060" to .080" | 2 each | 2 each | SD-LB-060-080 |
| Latching Block with SEM Screws | .080" to .125" | 2 each | 2 each | SD-LB-125 |

D-Subminiature Backshells - Gray With All-Plastic Connectors SDH Series

Fits only T Series All-Plastic IDC connector on page 14.

Straight (180°) Cable Entry Gray Backshells for All-Plastic Connectors

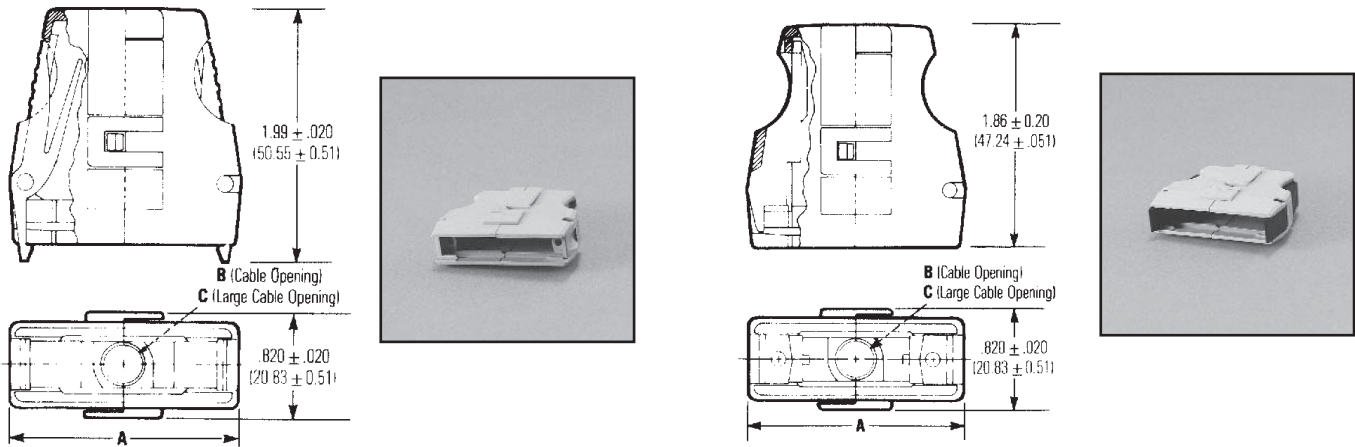

Dimensions

| Positions | A ± .020" (.58mm) | | B ± .020" (.58mm) | | C ± .020" (.58mm) | |
|-----------|-------------------|-------|-------------------|------|-------------------|-------|
| | in | mm | in | mm | in | mm |
| 9 | 1.47 | 37.34 | .31 | 7.87 | - | - |
| 15 | 1.80 | 45.72 | .31 | 7.87 | .41 | 10.41 |
| 25 | 2.35 | 59.69 | .33 | 8.40 | .47 | 11.94 |
| 37 | 2.99 | 75.95 | .37 | 9.40 | .50 | 12.70 |

Ordering Information

Straight (180°) Cable Entry Gray Backshells for All-Plastic Connectors

| Positions | Latches | Filler Ends | Filler Ends w/4-40 Screws |
|-----------|------------------------|------------------------|---------------------------|
| | Standard Cable Opening | Standard Cable Opening | Large Cable Opening |
| 9 | SDH-9GL | SDH-9GF | N/A |
| 15 | SDH-15GL | SDH-15GF | SDH-15GFLCS |
| 25 | SDH-25GL | SDH-25GF | SDH-25GFLCS |
| 37 | SDH-37GL | SDH-37GF | SDH-37GFLCS |

D-SUBMINIATURE CONNECTORS

D-Subminiature Backshells - Gray Use With All-Plastic Connectors SDH Series

Right-Angle (90°) Cable Entry Gray Backshells for All-Plastic Connectors

Fits only IDC connector on pages 14-39.

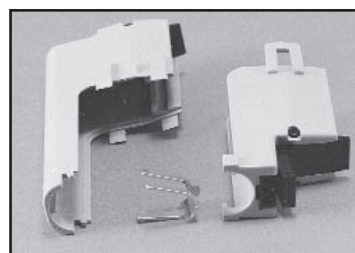
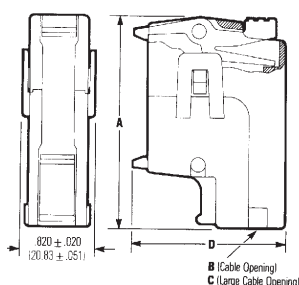

Dimensions

| Positions | A ± .020" (.58mm) | | B ± .020" (.58mm) | | C ± .020" (.58mm) | | D ± .020" (.58mm) | |
|-----------|-------------------|-------|-------------------|------|-------------------|-------|-------------------|-------|
| | in | mm | in | mm | in | mm | in | mm |
| 9 | 1.94 | 49.21 | .31 | 7.87 | - | - | 1.25 | 31.75 |
| 15 | 2.25 | 57.15 | .31 | 7.87 | .41 | 10.41 | 1.34 | 34.13 |
| 25 | 2.94 | 74.61 | .33 | 8.40 | .47 | 11.94 | 1.50 | 38.10 |
| 37 | 3.59 | 91.28 | .37 | 9.40 | .50 | 12.70 | 1.53 | 38.89 |

Ordering Information

Right Angle (90°) Cable Entry Gray Backshells for All-Plastic Connectors

| Positions | Latches |
|-----------|------------------------|
| | Standard Cable Opening |
| 9 | SDH-9RGL |
| 15 | SDH-15RGL |
| 25 | SDH-25RGL |
| 37 | SDH-37RGL |

Ordering Information

Accessories for Gray Backshells

| Positions | Optional Strain Reliefs* | Additional Stay Bands** |
|-----------|--------------------------|-------------------------|
| 9 | SD-WC9 | SD-9-15-SB |
| 15 | SD-WC15 | SD-9-15-SB |
| 25 | SD-WC25 | SD-25-37-SB |
| 37 | SD-WC37 | SD-25-37-SB |

* Two each required per backshell.

** Stay band tool #SD-MSBT required.

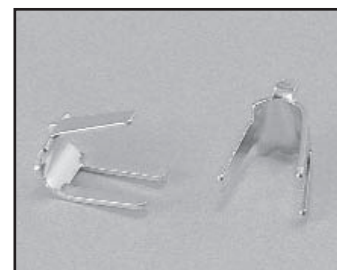
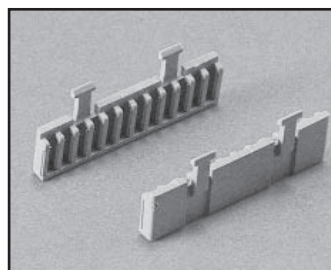

Screw for screwlocking connector assembly -(2 each required): 4-40UNC2ZX3/4.

D-Subminiature Junction Shells

Material Specifications

| | |
|-----------------------|---|
| Shell Material | Zinc-plated low carbon steel with yellow chromate finish or clear chromate finish |
| Clamp | Zinc-plated steel with yellow chromate finish |
| Screw | Zinc-plated steel with yellow chromate finish |
| Stop Nut | Zinc-plated brass with yellow chromate finish |

Round Clamp

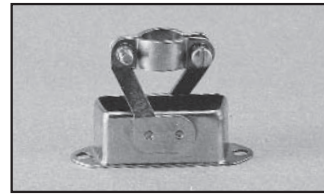
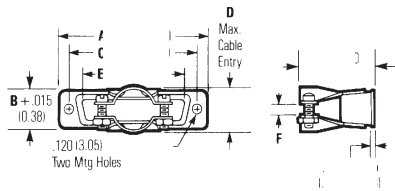

| Shell Size | Positions | A | | B | | C | | D | | E | | F | | G | |
|------------|-----------|-------|-------|------|-------|-------|-------|------|-------|-------|-------|------|------|-------|-------|
| | | in | mm | in | mm | in | mm | in | mm | in | mm | in | mm | in | mm |
| A | 15 | 1.531 | 38.89 | .500 | 12.70 | 1.312 | 33.32 | .406 | 10.31 | .984 | 23.72 | .125 | 3.18 | 1.031 | 26.19 |
| B | 25 | 2.078 | 52.78 | .500 | 12.70 | 1.852 | 47.04 | .593 | 15.06 | 1.515 | 38.48 | .187 | 4.75 | 1.062 | 26.97 |

Right-Angle Clamp

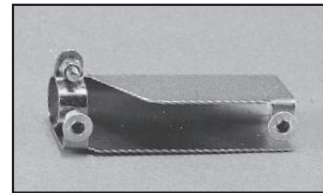
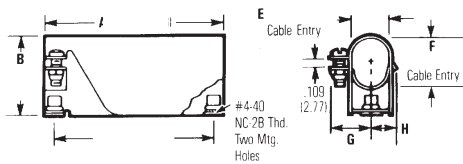

| Shell Size | Positions | A | | B | | C | | E | | F | | G | | H | |
|------------|-----------|-------|-------|-------|-------|-------|-------|------|-------|------|-------|------|-------|------|------|
| | | in | mm | in | mm | in | mm | in | mm | in | mm | in | mm | in | mm |
| E | 9 | 1.203 | 30.56 | 0.718 | 18.24 | .984 | 24.99 | .437 | 11.10 | .437 | 11.10 | .468 | 11.89 | .281 | 7.14 |
| A | 15 | 1.531 | 38.89 | 0.718 | 18.24 | 1.312 | 33.32 | .437 | 11.10 | .437 | 11.10 | .468 | 11.89 | .281 | 7.14 |
| B | 25 | 2.078 | 52.78 | 0.968 | 24.59 | 1.852 | 47.04 | .437 | 11.10 | .625 | 15.88 | .468 | 11.89 | .281 | 7.14 |
| C | 37 | 2.718 | 69.04 | 1.187 | 30.15 | 2.500 | 63.50 | .437 | 11.10 | .812 | 20.62 | .468 | 11.89 | .281 | 7.14 |
| D | 50 | 2.625 | 66.68 | 1.250 | 31.75 | 2.406 | 61.11 | .562 | 14.27 | .906 | 23.01 | .531 | 13.49 | .343 | 8.71 |

D-SUBMINIATURE CONNECTORS

D-Subminiature Junction Shells

Deep Straight Clamp

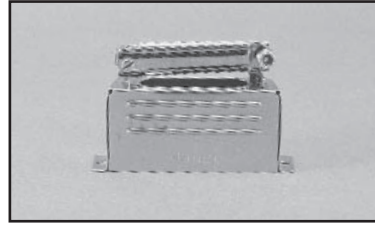
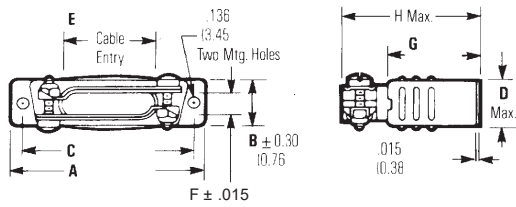

| Shell Size | Positions | A | | B | | C | | D | | E | | F | | G | | H | |
|------------|-----------|-------|-------|------|-------|-------|-------|------|-------|-------|-------|------|-------|-------|-------|-------|-------|
| | | in | mm | in | mm | in | mm | in | mm | in | mm | in | mm | in | mm | in | mm |
| E | 9 | 1.203 | 30.56 | .484 | 12.29 | .984 | 24.99 | .578 | 14.68 | .375 | 9.53 | .375 | 9.53 | .750 | 19.05 | 1.219 | 30.96 |
| A | 15 | 1.531 | 38.89 | .484 | 12.29 | 1.312 | 33.32 | .578 | 14.68 | .713 | 18.11 | .312 | 7.92 | .750 | 19.05 | 1.250 | 31.75 |
| B | 25 | 2.078 | 52.78 | .484 | 12.29 | 1.852 | 47.04 | .578 | 14.68 | 1.000 | 25.40 | .312 | 7.92 | 1.000 | 25.40 | 1.531 | 38.89 |
| C | 37 | 2.718 | 69.04 | .484 | 12.29 | 2.500 | 63.50 | .578 | 14.68 | 1.375 | 34.93 | .312 | 7.92 | 1.000 | 25.40 | 1.531 | 38.89 |
| D | 50 | 2.625 | 66.68 | .593 | 15.06 | 2.406 | 61.11 | .687 | 17.45 | 1.406 | 35.71 | .406 | 10.31 | 1.125 | 28.58 | 1.656 | 42.06 |

Switching Shell

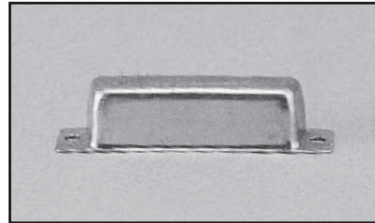
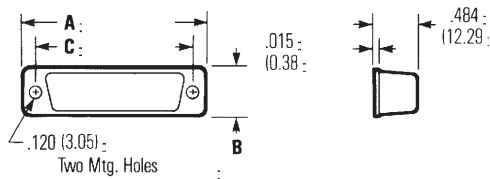

| Shell Size | Positions | A | | B | | C | |
|------------|-----------|-------|-------|------|-------|-------|-------|
| | | in | mm | in | mm | in | mm |
| A | 15 | 1.531 | 38.89 | .500 | 12.70 | 1.312 | 33.32 |
| B | 25 | 2.078 | 52.78 | .500 | 12.70 | 1.852 | 47.04 |
| C | 37 | 2.718 | 69.04 | .500 | 12.70 | 2.500 | 63.50 |
| D | 50 | 2.625 | 66.68 | .609 | 15.47 | 2.406 | 61.11 |

Ordering Information

Junction Shells - Metal

| Shell Size | Fits Standard Density | Yellow Chromate | | | | RoHS Clear Chromate | |
|------------|-----------------------|-----------------|-------------------|---------------------|-----------------|---------------------|---------------------|
| | | Round Clamp | Right-Angle Clamp | Deep Straight Clamp | Switching Shell | Right-Angle Clamp | Deep Straight Clamp |
| E | 9 | N/A | DE-19977-5 | DE-24857 | N/A | DE-19977-30 | DE-24657-30 |
| A | 15 | DA-20961 | DA-19977-1 | DA-24658 | DA-19678-6 | DA-19977-31 | DA-24658-31 |
| B | 25 | DB-20962 | DB-19977-2 | DB-24659 | DB-19678-7 | DB-19977-32 | DB-24659-32 |
| C | 37 | N/A | DC-19977-3 | DC-24660 | | | DC-24660-33 |
| D | 50 | N/A | DD-19977-4 | | | | |

D-Subminiature Plastic Hoods

All-Plastic Straight (180°) Hood

Shell Material: Nylon (gray).

#4-40 Screws: Steel with nickel plating.

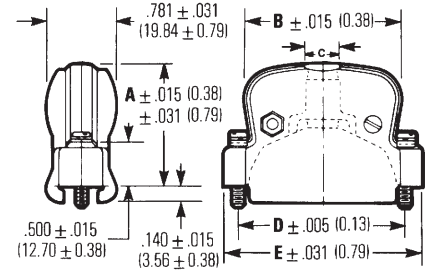
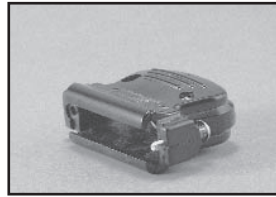

| Shell Size | Positions | A | | B | | C | | D | | E | | F | | G | |
|------------|-----------|-------|-------|-------|-------|-------|-------|------|-------|------|-------|------|-------|------|------|
| | | in | mm | in | mm | in | mm | in | mm | in | mm | in | mm | in | mm |
| E | 9 | 1.218 | 30.94 | 1.000 | 25.40 | .984 | 23.72 | .500 | 12.70 | .562 | 14.27 | .281 | 7.14 | .218 | 7.14 |
| A | 15 | 1.546 | 38.27 | 1.000 | 25.40 | 1.312 | 33.32 | .500 | 12.70 | .562 | 14.27 | .360 | 9.14 | .360 | 9.14 |
| B | 25 | 2.093 | 53.16 | 1.250 | 31.75 | 1.852 | 47.04 | .500 | 12.70 | .562 | 14.27 | .493 | 12.52 | .360 | 9.14 |

Ordering Information

Plastic Hoods

| Shell Size | Standard Density | Straight Hood |
|------------|------------------|---------------|
| E | 9 | DE-51218-1 |
| A | 15 | DA-51210-1 |
| B | 25 | |
| C | 37 | N/A |
| D | 50 | N/A |
| A | 15 | |

D-SUBMINIATURE CONNECTORS

D-Subminiature Accessories

Dust Caps

- For use with all Cinch D-subminiature connectors.
- Used to protect connector contacts when connector is not mated.
- Made of polyethylene (black).

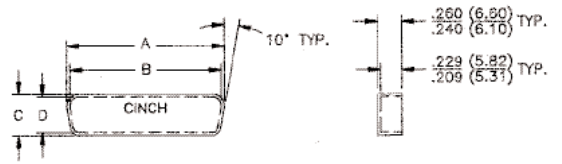

Ordering Information

| Fits Shell Size | Fits Standard Density | Catalog No. | Description | A | | B | | C | | D | |
|-----------------|-----------------------|-------------|-------------|-------|-------|-------|-------|------|-------|------|-------|
| | | | | in | mm | in | mm | in | mm | in | mm |
| E | 9 | DE-59-20 | Socket | .694 | 17.63 | .627 | 15.93 | .362 | 9.19 | .295 | 7.49 |
| E | 9 | DE-60-20 | Plug | .749 | 19.02 | .682 | 17.32 | .412 | 10.46 | .345 | 8.76 |
| A | 15 | DA-59-20 | Socket | 1.022 | 25.95 | .955 | 24.25 | .362 | 9.19 | .295 | 7.49 |
| A | 15 | DA-60-60 | Plug | 1.077 | 27.36 | 1.010 | 25.65 | .412 | 10.46 | .345 | 8.76 |
| B | 25 | DB-59-20 | Socket | 1.562 | 39.67 | 1.495 | 37.97 | .362 | 9.19 | .295 | 7.49 |
| B | 25 | DB-60-20 | Plug | 1.635 | 41.52 | 1.568 | 39.83 | .430 | 10.92 | .365 | 9.22 |
| C | 37 | DC-59-20 | Socket | 2.210 | 56.13 | 2.143 | 54.43 | .362 | 9.19 | .295 | 7.49 |
| C | 37 | DC-60-20 | Plug | 2.283 | 57.99 | 2.216 | 56.29 | .430 | 10.92 | .363 | 9.22 |
| D | 50 | DD-59-20 | Socket | 2.116 | 53.75 | 2.049 | 52.04 | .474 | 12.04 | .407 | 10.34 |
| D | 50 | DD-60-20 | Plug | 2.179 | 55.35 | 2.112 | 53.64 | .536 | 13.61 | .469 | 11.91 |

D-Subminiature Accessories

Slide Lock Assemblies

- A slide lock assembly is a metal bracket offered with hardware necessary to mount into the standard connector mounting holes. It consists of the lock retainer plate, two screws, two washers, and two nuts. Two lock posts are required to fit into the mounting holes of the mating connector. These must be ordered separately.
- Compatible with all Cinch Backshells, Hoods, and Junction Shells except D*H Series, SDH Series, and phenolic hood.
- Compatible with all Cinch metal shell D-subminiature connectors.

Material Specifications

| | |
|--|--|
| Slide Lock Plate | Stainless steel, passivated. |
| Slide Lock Hex Nut, Washer #4-40 Screw | Steel with zinc plating and yellow chromate finish |
| Lockpost, Washer, Lockwasher, and Hex Nut | Steel with zinc plating and yellow chromate finish |

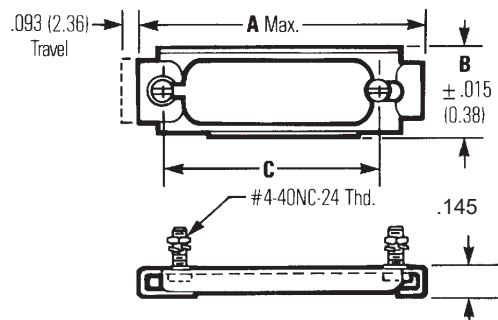
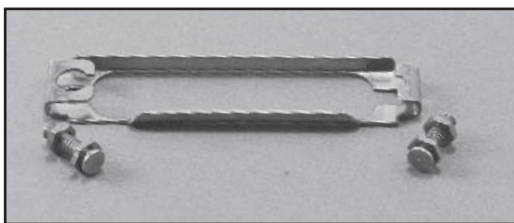

Consists of Lock Retainer and two lock posts (order separately).
NOTE: Not compatible with D*H Series or SDH Series backshells.

Ordering Information

| Fits Shell Size | Fits Standard Density | Lock Retainer | A | | B | | C | |
|-----------------|-----------------------|---------------|-------|-------|------|-------|-------|-------|
| | | | in | mm | in | mm | in | mm |
| E | 9 | DE-51224-1 | 1.442 | 36.63 | .500 | 12.70 | 0.984 | 24.99 |
| A | 15 | DA-51220-1 | 1.770 | 44.96 | .500 | 12.70 | 1.312 | 33.27 |
| B | 25 | DB-51221-1 | 2.293 | 58.24 | .500 | 12.70 | 1.852 | 47.04 |
| C | 37 | DC-51222-1 | 2.958 | 75.13 | .500 | 12.70 | 2.500 | 63.50 |
| D | 50 | DD-51223-1 | 2.847 | 72.31 | .609 | 15.47 | 2.406 | 62.48 |

Lock Post: #D53018. Two (2) required with each Slide Lock Assembly.

D-Subminiature Hardware Accessories

Screwlocks

- Screwlocks are designed to retain the same size mated connectors together or to secure the connector to a rack/panel. Screwlocks may be used on plugs or sockets.
- Female screwlocks consist of one #4-40 screw with a #4-40 hole in the top, two flat washers to accommodate different panel thicknesses, one lockwasher, and one #4-40 nut. Military female screwlocks include three flat washers.
- Male screwlocks consist of one #4-40 slotted screw and a spring tension clip. Different sizes accommodate the various connector flange sizes and types of backshells or hoods (if applicable).
- Two screwlocks are required per connector.
- Military screwlocks meet all requirements of MIL-C-24308.

Material Specifications

Commercial Screwlock Assemblies

Male Screwlock Assembly

Clip and screw are steel with zinc plating and yellow chromate finish – RoHS has clear chromate finish

Female Screwlock Assembly

Washers (2), lockwashers, hex nuts, and nuts are steel with zinc plating and yellow chromate finish - RoHS has clear chromate finish

M24308 Military Screwlock Assemblies

Male Screwlock Assembly

Clip and screw are steel with cadmium plating and yellow chromate finish

Female Screwlock Assembly

Washers (3), lockwashers, hex nuts, and nuts are steel with cadmium plating and yellow chromate finish

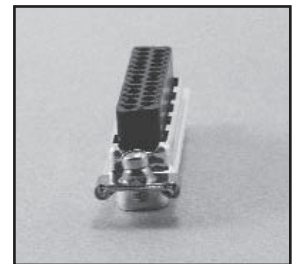
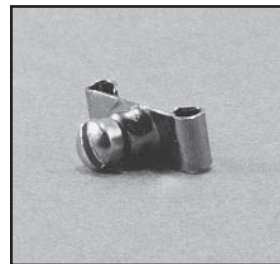
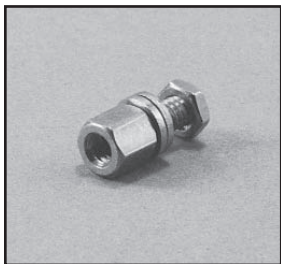

Female Screwlock

Male Screwlock

D-Subminiature Accessories

Screwlock assemblies will not fit D*H or SDH Series backshells.

Male Screwlocks

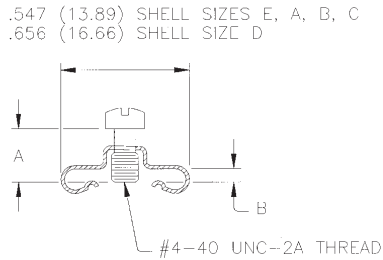

Female Screwlocks

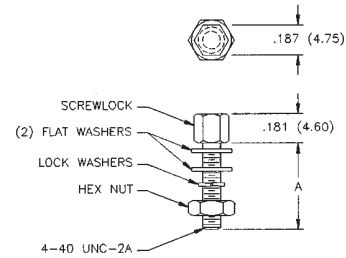

Ordering Information - Male Screwlocks

| Shell Size Positions | A | | B | | E | A | B | C | D | RoHS |
|-----------------------------|--------------|------|-------|------|-----|-----|------|------|------|------|
| | in | mm | in | mm | 9 | 15 | 25 | 37 | 50 | |
| Commercial: | | | | | | | | | | |
| D20419-46 | 0.250 | 6.35 | 0.048 | 1.22 | S* | S* | P/S* | P/S* | | X |
| D20419-40 | 0.250 | 6.35 | 0.033 | 0.84 | P/S | P/S | S | S | | X |
| D20419-0 | 0.250 | 6.35 | 0.033 | 0.84 | P/S | P/S | S | S | | |
| D20419-16 | 0.250 | 6.35 | 0.048 | 1.22 | S* | S* | P/S* | P/S* | | |
| D20419-21 | 0.281 | 7.14 | 0.059 | 1.50 | | P* | P* | | | |
| D20420-0 | 0.250 | 6.35 | 0.033 | 0.84 | | | | | S | |
| D20420-12 | 0.281 | 7.14 | 0.048 | 1.22 | | | | | P/S* | |
| D20420-42 | 0.281 | 7.14 | 0.048 | 1.22 | | | | | P/S* | X |
| Military MIL-C-24308 | | | | | | | | | | |
| M24308/25-9F | Per MIL spec | | | | P/S | P/S | P/S | P/S | | |
| M24308/25-10F | Per MIL spec | | | | | | | | P/S | |

NOTE: P=Plug, S=Socket
* Indicates use with junction shell

Ordering Information - Female Screwlocks

| Shell Size Positions | A | | E | A | B | C | D | RoHS |
|-----------------------------|--------------|-------|-----|-----|-----|-----|-----|------|
| | in | mm | 9 | 15 | 25 | 37 | 50 | |
| Commercial: | | | | | | | | |
| D20418-42 | 0.312 | 7.92 | P/S | P/S | P/S | P/S | P/S | X |
| D20418-39 | 0.628 | 15.95 | P/S | P/S | P/S | P/S | P/S | X |
| Military MIL-C-24308 | | | | | | | | |
| M24308/26-1F | Per MIL spec | | P/S | P/S | P/S | P/S | P/S | |
| M24308/26-2F | Per MIL spec | | P/S | P/S | P/S | P/S | P/S | |

NOTE: P=Plug, S=Socket

D-Subminiature IDC Termination Tools

Super D™ Manual Stay Band Tool

Designed for applying the steel stay band/strain relief to the cable before termination of wires to the connector, the manual Stay Band Tool applies both stay band sizes to the full range of cable sizes.

Part No. SD-MSBT

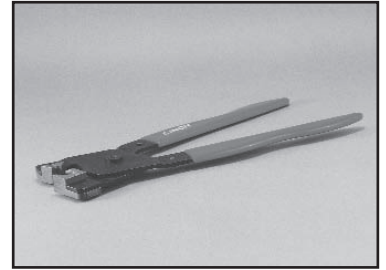

Manual Tool

Uni-Clinch™ D Single-Wire Hand Insertion Tool

Designed to insert one 22-26 AWG wire at a time, Uni-Cinch D is used as a field repair tool by field service engineers.

Part No.: SD-UC

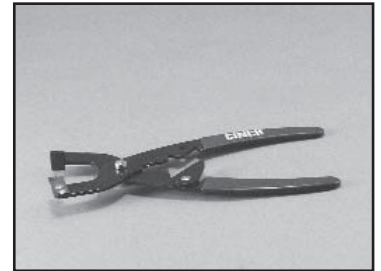

Uni-Clinch Hand Insertion Tool

NOTE: All termination tools on this page are used in conjunction with T* Series D-subminiature connectors.

D-Subminiature Crimp and Poke Termination Tools

Metal Shell High-Reliability Crimp and Poke Termination Tool

Hand crimping tool for high-reliability machined D*U, Series 3, and M24308 Crimp and Poke contacts.

M22520/2-01

NOTE: Positioner required with crimping tool

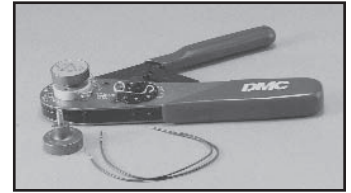

M22520/2-01

Positioner --

A device when attached to a crimping tool that locates the contact in the correct position.

Positioner for machined contacts

D*U Series Positioner

Part No.: 599-11-11-580

Catalog No.: EP-580

Series 3 and M24308 Connector Positioner

Part No.: 598-98-97-618

Catalog No.: M22520/2-08

Metal Shell Military Crimp and Poke Insertion/Extraction Tool

For inserting or extracting machined D*U, Series 3, or M24308 Crimp and Poke contacts.

Part No.: CIET-20-HD

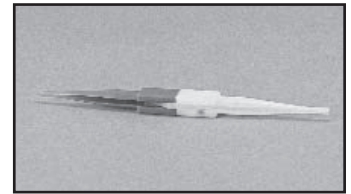

CIET-20-HD

Military Extraction Tip Only

For extracting high-reliability machined D*U, Series 3, or M24308 Crimp and Poke contacts.

Part No.: CET-20-11

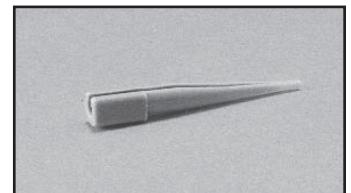

CET-20-11



About Cinch Connectivity Solutions

In operation since 1917, Cinch supplies high quality, high performance connectors and cables globally to the Aerospace, Military/Defense, Commercial Transportation, Oil & Gas, High End Computer, and other markets. We provide custom solutions with our creative, hands on engineering and end to end approach.

Our diverse product offerings include: connectors, enclosures and cable assemblies utilizing multiple contact technologies including copper and fiber optics. Our product engineering and development activities employ cutting edge technologies for design and modeling, and our various technologies and expertise enable us to deliver custom solutions and products for our strategic partnerships.

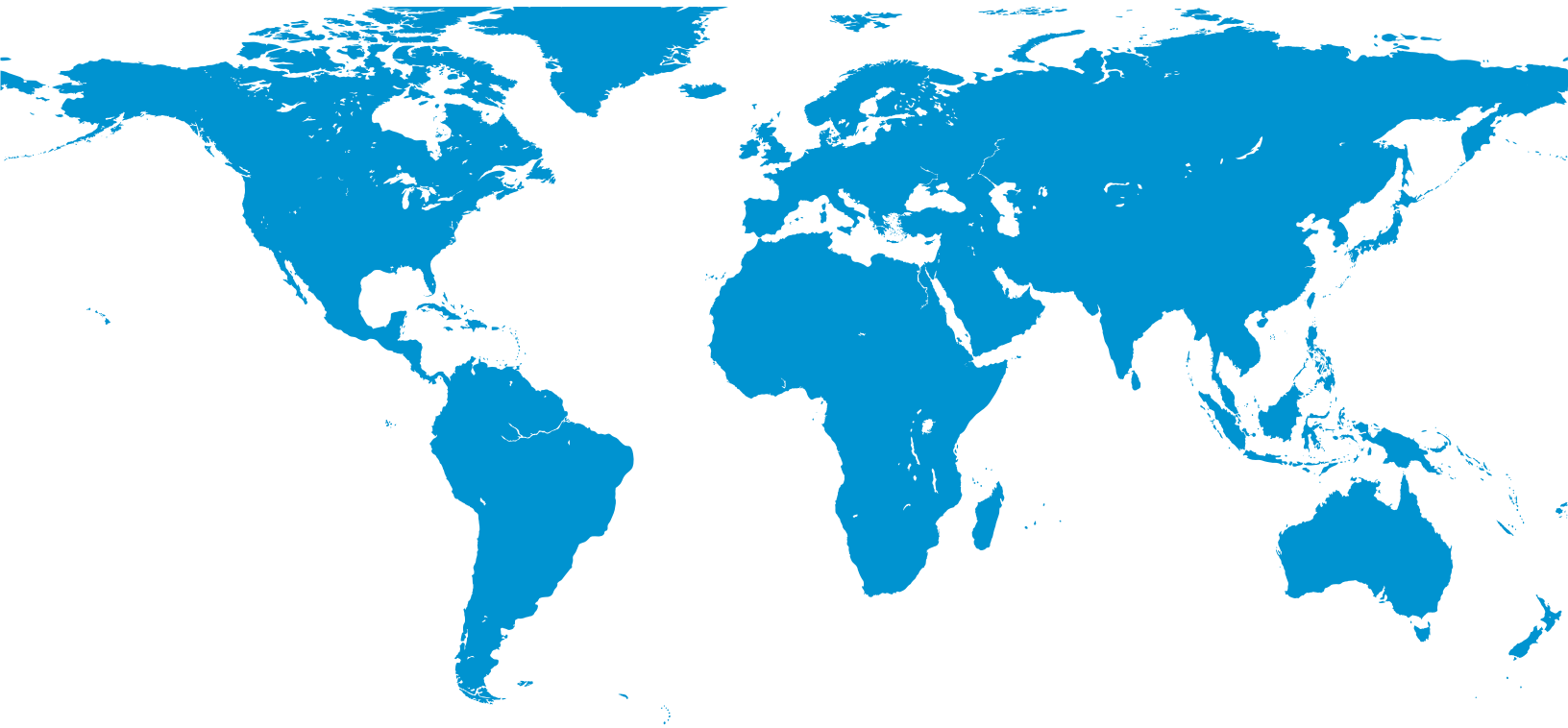

For more information, please contact us:

North America

+1 507.833.8822
ccsorders@us.cinch.com

Asia-Pacific

+86 21 5442 7668
ccs.asia.sales@as.cinch.com

Europe, Middle East

+44 (0) 1245 342060
CinchConnectivity@eu.cinch.com

belfuse.com/cinch

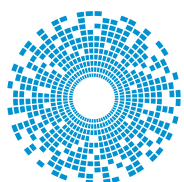

cinch
CONNECTIVITY SOLUTIONS

a bel group

Mouser Electronics

Authorized Distributor

Click to View Pricing, Inventory, Delivery & Lifecycle Information:

Cinch Connectivity Solutions:

[DCM37S](#) [DCM37P](#) [DBM25P](#) [DBM25S](#) [DAM15P](#) [DAM15S](#) [DEM9S](#) [DEM9P](#) [DCMA37S](#) [DBMA25P](#) [DAMA15P](#)
[DAMA15S](#) [DEMA9S](#) [DDMA50S](#) [DDMA50P](#) [DCMA37P](#) [DEMA9P](#) [DBMAM25S](#) [DDMM50P](#) [DEMM9S](#) [DEMAM9P](#)
[DEMA9STFO](#) [DBM25PTI](#) [DAM15ST](#) [DCMA37PFO](#) [DAMAM15P](#) [DCMAM37P](#) [DDM50P](#) [DBMF25P](#) [DBMA25PTI](#)
[DCMA37PTI](#) [DBMAM25P](#) [DCMAM37S](#) [DBMA25S](#) [DBME25PTI](#) [DBMA25ST](#) [DAMAM15S](#) [DEMA9PTI](#) [DAMM15P](#)
[DEM9SA156](#) [DEMM9P](#) [DAMA15SFO](#) [DEMAM9S](#) [DDMAM50P](#) [DBMA25PFO](#)