

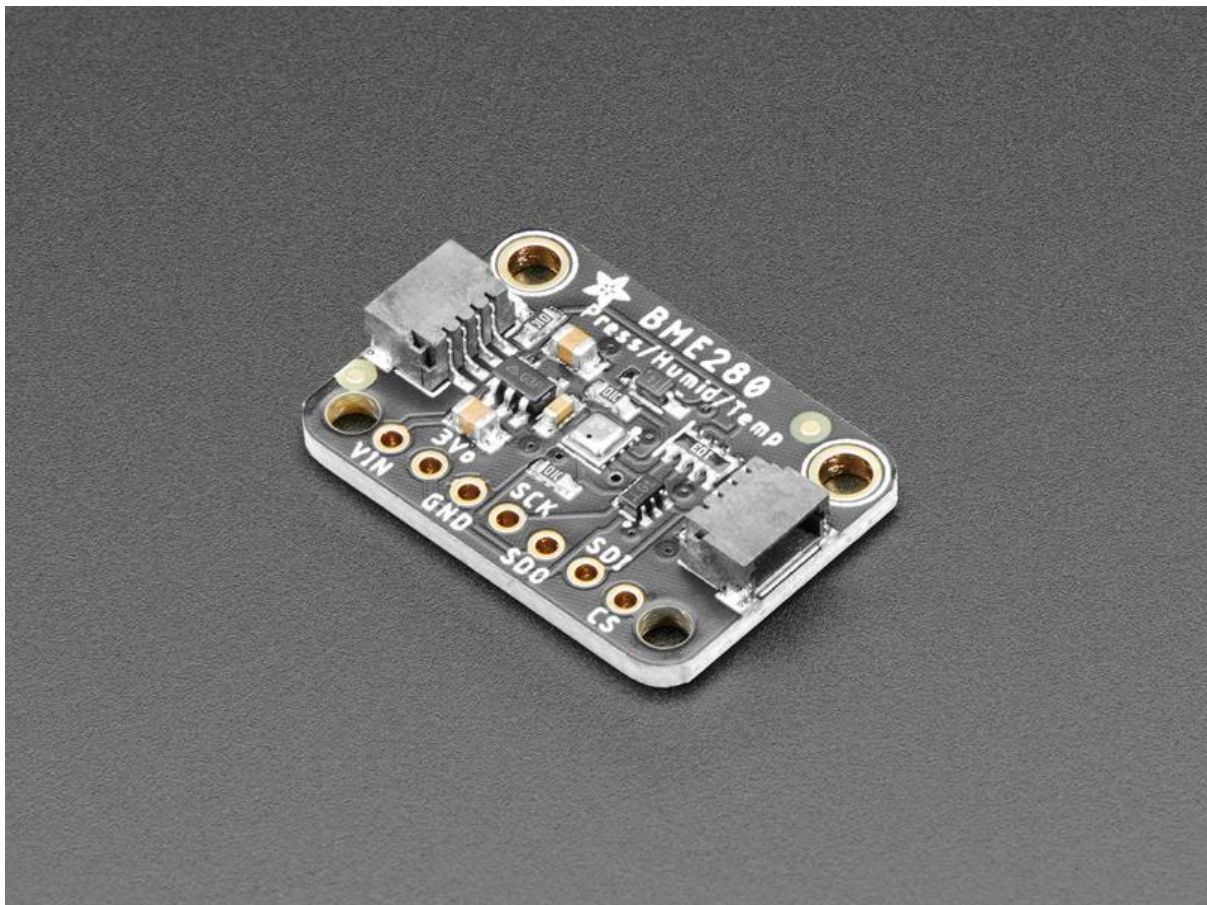

Adafruit BME280 Humidity + Barometric Pressure + Temperature Sensor Breakout

Created by lady ada



<https://learn.adafruit.com/adafruit-bme280-humidity-barometric-pressure-temperature-sensor-breakout>

Last updated on 2021-11-15 06:30:51 PM EST

Table of Contents

Overview	3
Pinouts	6
• Power Pins:	6
• SPI Logic pins:	7
• I2C Logic pins:	7
Assembly	7
• Prepare the header strip:	8
• Add the breakout board:	8
• And Solder!	9
Arduino Test	9
• I2C Wiring	10
• SPI Wiring	11
• Install Adafruit_BME280 library	11
• Load Demo	12
• Library Reference	14
Python & CircuitPython Test	16
• CircuitPython Microcontroller Wiring	16
• Python Computer Wiring	18
• CircuitPython Installation of BME280 Library	20
• Python Installation of BME280 Library	21
• CircuitPython & Python Usage	21
• Full Example Code	23
Python Docs	23
F.A.Q.	23
Downloads	24
• Documents	24
• Alternative Driver (Python)	24
• Schematic and Fab Print for STEMMA QT Version	25
• Schematic and Fab Print for Original Version	25

Overview

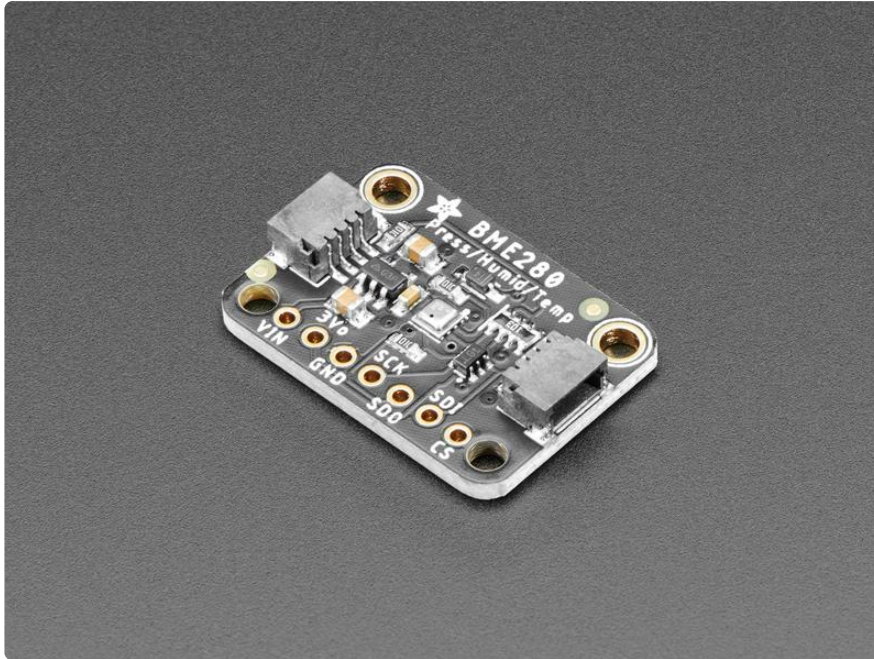

Bosch has stepped up their game with their new BME280 sensor, an environmental sensor with temperature, barometric pressure and humidity! This sensor is great for all sorts of weather/environmental sensing and can even be used in both I2C and SPI!

This precision sensor from Bosch is the best low-cost sensing solution for measuring humidity with $\pm 3\%$ accuracy, barometric pressure with ± 1 hPa absolute accuracy, and temperature with $\pm 1.0^\circ\text{C}$ accuracy. Because pressure changes with altitude, and the pressure measurements are so good, you can also use it as an altimeter with ± 1 meter accuracy!

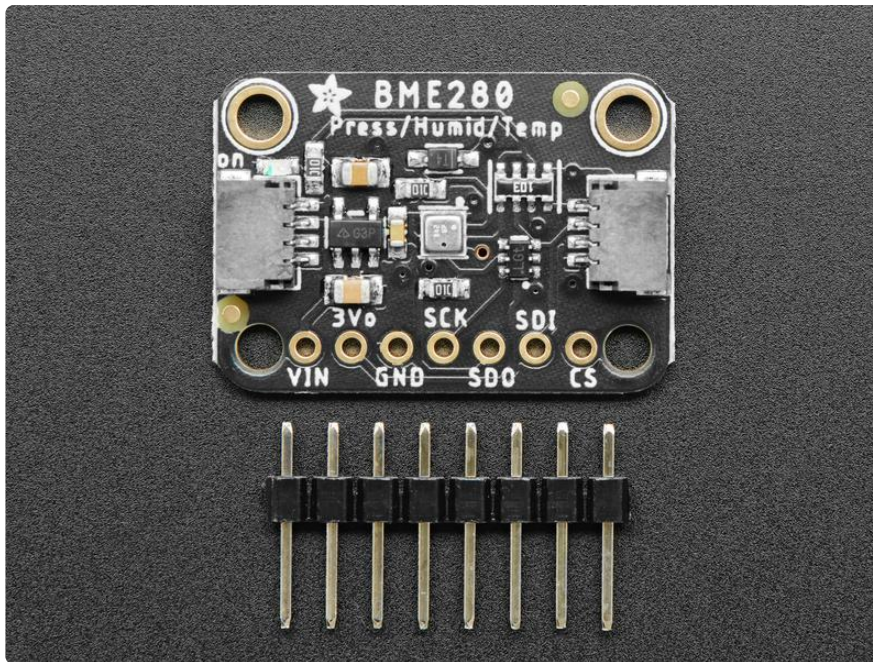

The BME280 is the next-generation of sensors from Bosch, and is the upgrade to the BMP085/BMP180/BMP183 - with a low altitude noise of 0.25m and the same fast conversion time. It has the same specifications, but can use either I2C or SPI. For simple easy wiring, go with I2C. If you want to connect a bunch of sensors without worrying about I2C address collisions, go with SPI.

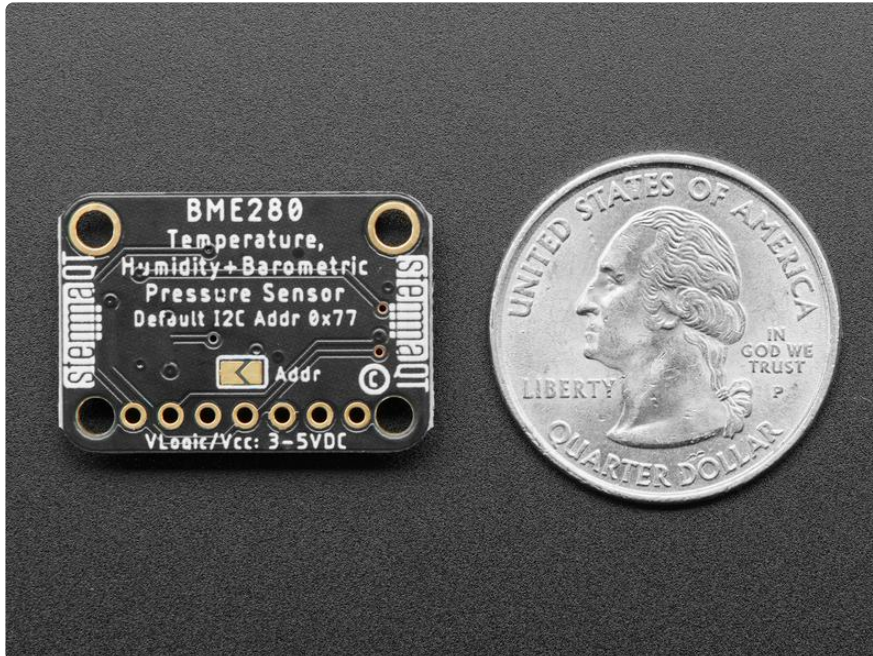

Nice sensor right? So we made it easy for you to get right into your next project. The surface-mount sensor is soldered onto a PCB and comes with a 3.3V regulator and level shifting so you can use it with a 3V or 5V logic microcontroller without worry.

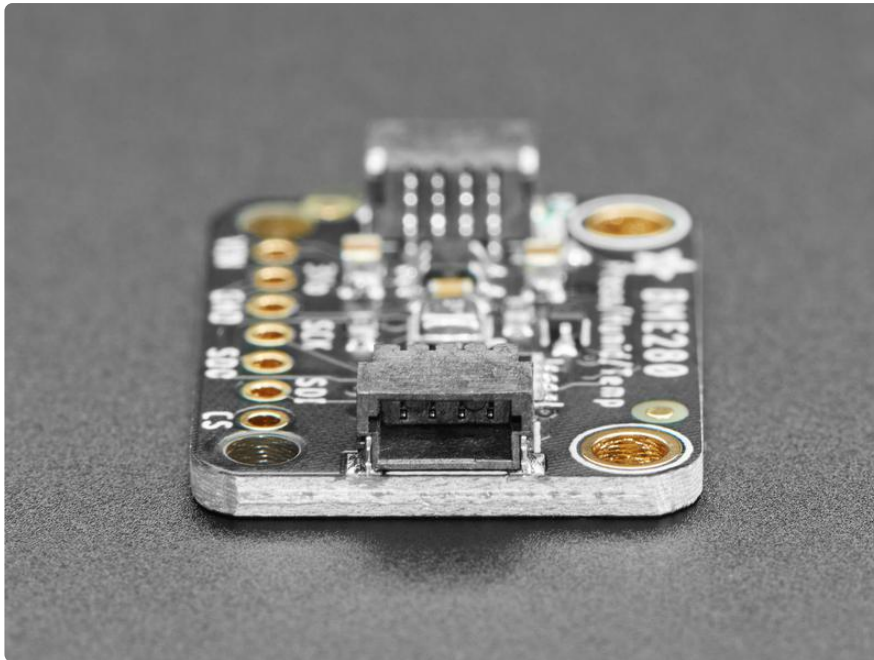

The breakout is made in the [STEMMA QT form factor \(https://adafru.it/LBQ\)](https://adafru.it/LBQ), making them easy to interface with. The [STEMMA QT connectors \(https://adafru.it/JqB\)](https://adafru.it/JqB) on either side are compatible with the [SparkFun Qwiic \(https://adafru.it/Fpw\)](https://adafru.it/Fpw) I2C connectors. This allows you to make solderless connections between your development board and the BME280 or to chain it with a wide range of other sensors and accessories using a [compatible cable \(https://adafru.it/JnB\)](https://adafru.it/JnB).

There are two versions of this board - the STEMMA QT version shown above, and the original header-only version shown below. Code works the same on both!

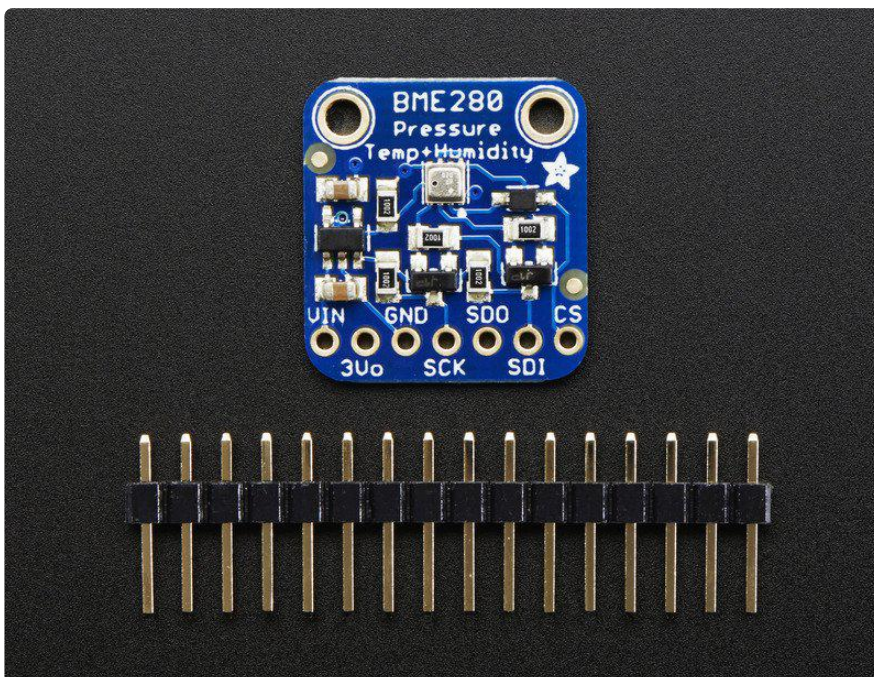

Pinouts

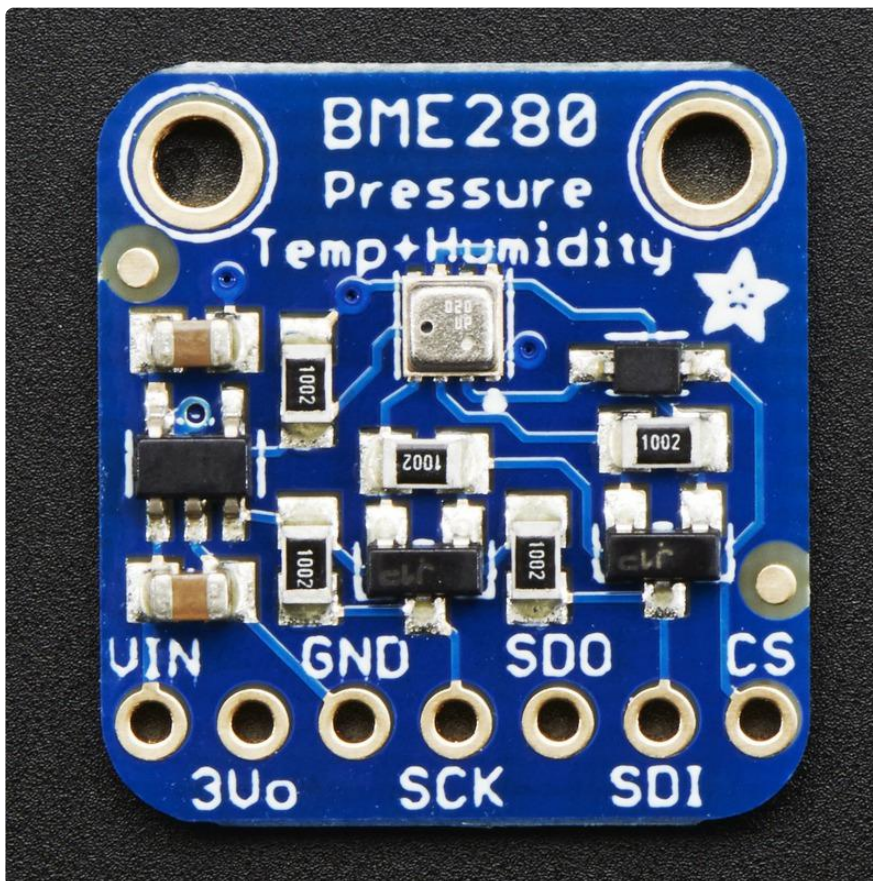
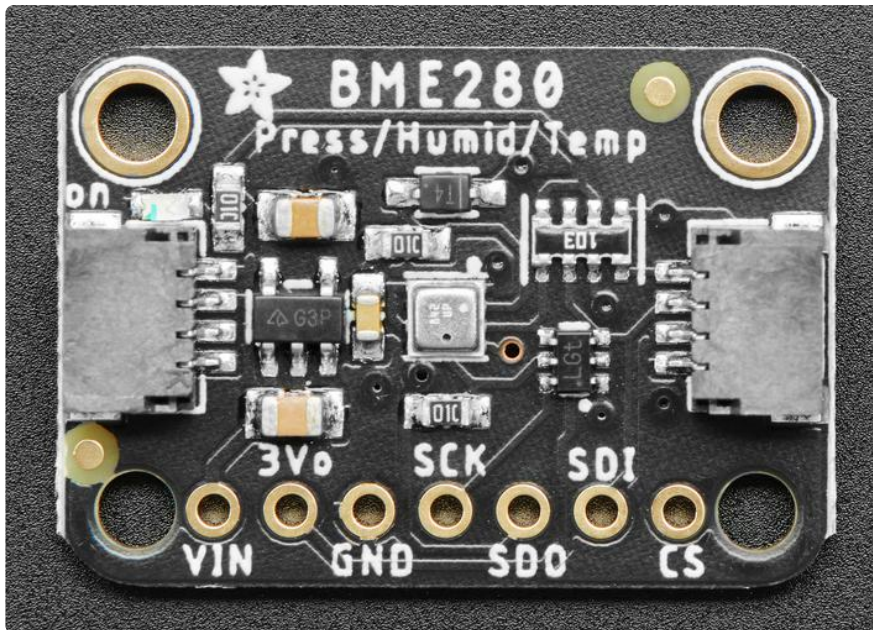

Power Pins:

- Vin - this is the power pin. Since the sensor chip uses 3 VDC, we have included a voltage regulator on board that will take 3-5VDC and safely convert it down.

To power the board, give it the same power as the logic level of your microcontroller - e.g. for a 5V micro like Arduino, use 5V

- 3Vo - this is the 3.3V output from the voltage regulator, you can grab up to 100mA from this if you like
- GND - common ground for power and logic

SPI Logic pins:

All pins going into the breakout have level shifting circuitry to make them 3-5V logic level safe. Use whatever logic level is on Vin!

- SCK - This is the SPI Clock pin, its an input to the chip
- SDO - this is the Serial Data Out / Microcontroller In Sensor Out pin, for data sent from the BMP183 to your processor
- SDI - this is the Serial Data In / Microcontroller Out Sensor In pin, for data sent from your processor to the BME280
- CS - this is the Chip Select pin, drop it low to start an SPI transaction. Its an input to the chip

If you want to connect multiple BME280's to one microcontroller, have them share the SDI, SDO and SCK pins. Then assign each one a unique CS pin.

I2C Logic pins:

- SCK - this is also the I2C clock pin, connect to your microcontrollers I2C clock line.
- SDI - this is also the I2C data pin, connect to your microcontrollers I2C data line.
- [STEMMA QT \(https://adafru.it/Ft4\)](https://adafru.it/Ft4) - These connectors allow you to connectors to dev boards with STEMMA QT connectors or to other things with [various associated accessories \(https://adafru.it/Ft6\)](https://adafru.it/Ft6)

Leave the other pins disconnected

Assembly

Your board may look a little different - the assembly process is the same!

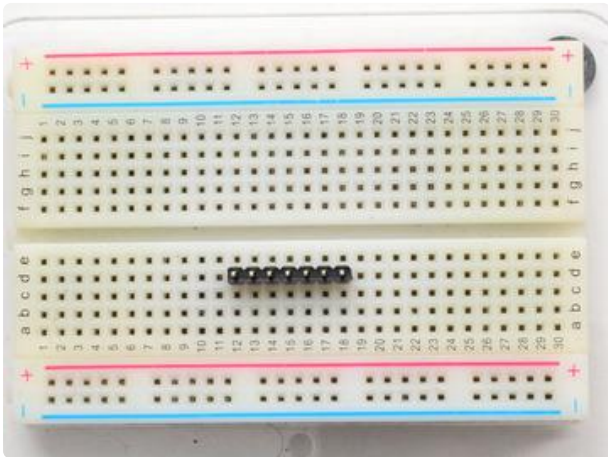
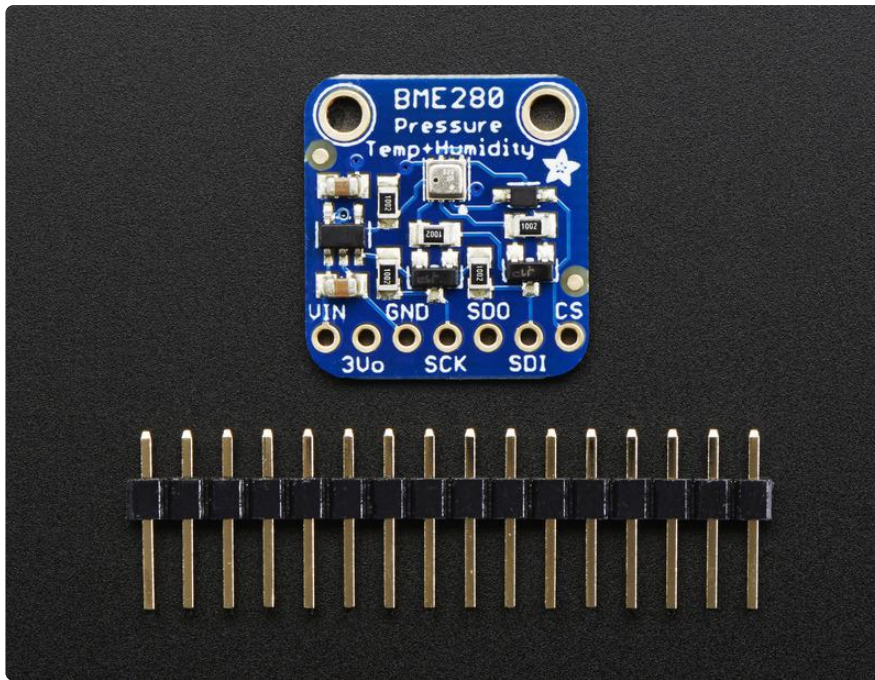

Prepare the header strip:
Cut the strip to length if necessary. It will be easier to solder if you insert it into a breadboard - long pins down

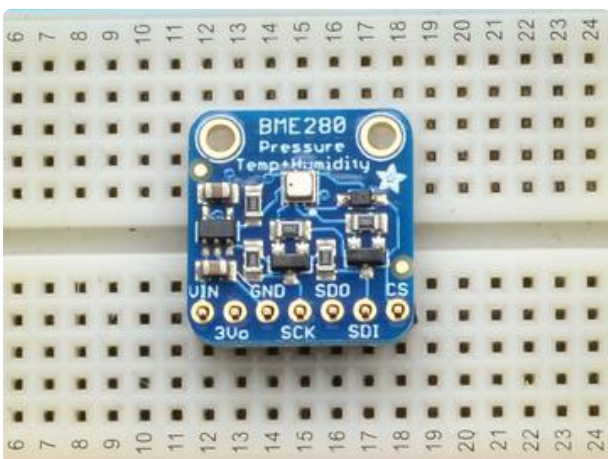

Add the breakout board:
Place the breakout board over the pins so that the short pins poke through the breakout pads

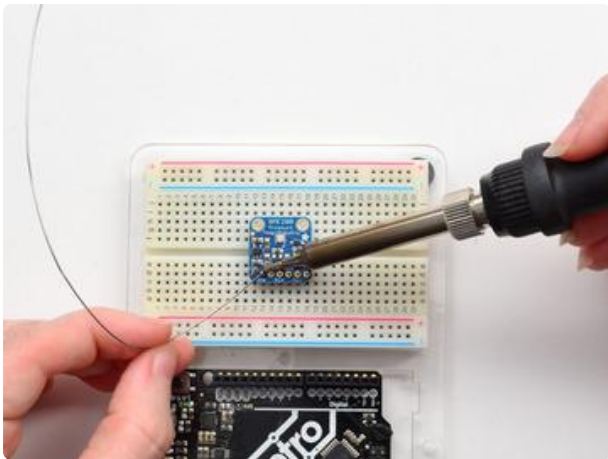

And Solder!

Be sure to solder all pins for reliable electrical contact.

(For tips on soldering, be sure to check out our [Guide to Excellent Soldering](https://adafru.it/aTk) (<https://adafru.it/aTk>)).

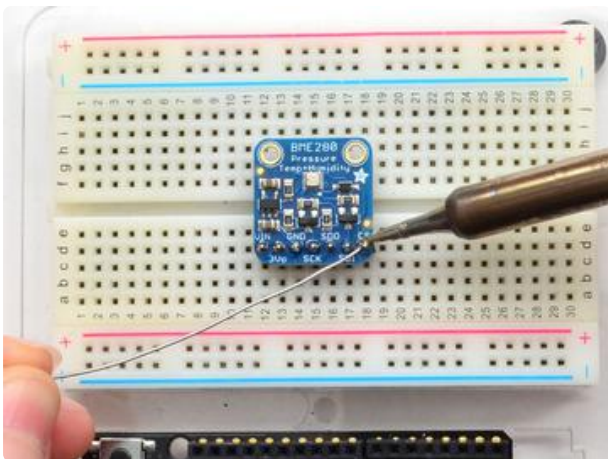

You're done! Check your solder joints visually and continue onto the next steps

Arduino Test

You can easily wire this breakout to any microcontroller, we'll be using an Arduino. For another kind of microcontroller, as long as you have 4 available pins it is possible to 'bit-bang SPI' or you can use two I2C pins, but usually those pins are fixed in hardware. Just check out the library, then port the code.

I2C Wiring

Use this wiring if you want to connect via I2C interface

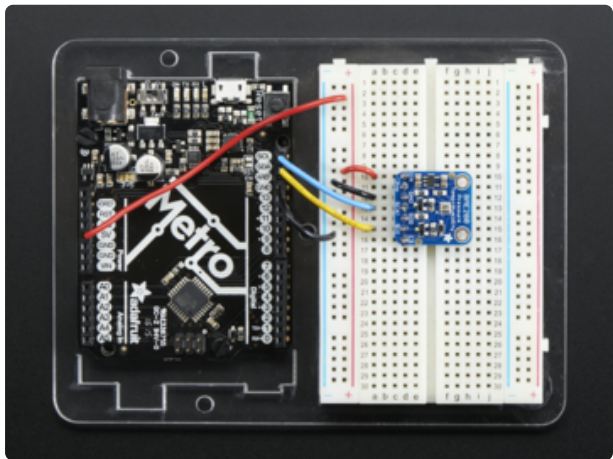
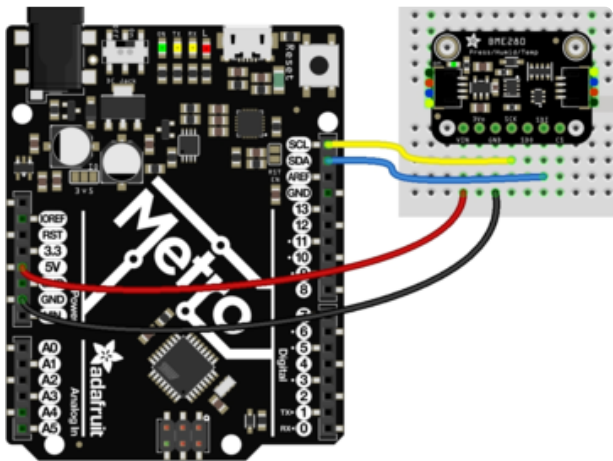
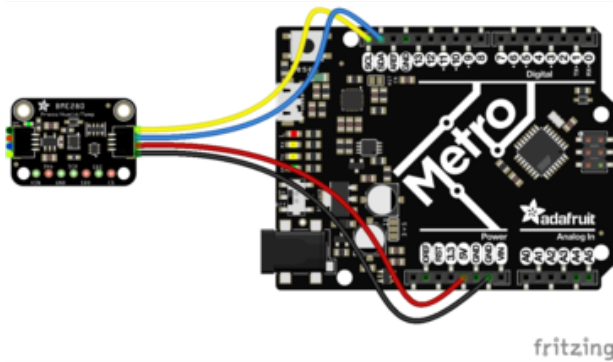

- Connect Vin to the power supply, 3-5V is fine. Use the same voltage that the microcontroller logic is based off of. For most Arduinos, that is 5V
- Connect GND to common power/ data ground
- Connect the SCK pin to the I2C clock SCL pin on your Arduino. On an UNO & '328 based Arduino, this is also known as A5, on a Mega it is also known as digital 21 and on a Leonardo/Micro, digital 3
- Connect the SDI pin to the I2C data SDA pin on your Arduino. On an UNO & '328 based Arduino, this is also known as A4, on a Mega it is also known as digital 20 and on a Leonardo/Micro, digital 2

By default, the i2c address is 0x77. If you add a jumper from SDO to GND, the address will change to 0x76.

In you are having intermittent issues with I2C on the original non-STEMMA version of the board, try also jumpering CS to Vin.

SPI Wiring

Since this is a SPI-capable sensor, we can use hardware or 'software' SPI. To make wiring identical on all Arduinos, we'll begin with 'software' SPI. The following pins should be used:

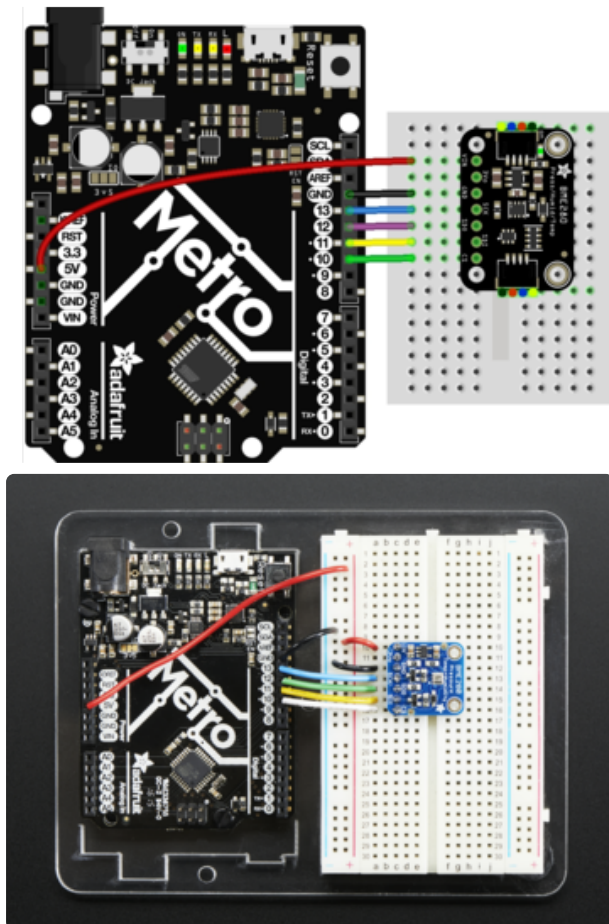

- Connect Vin to the power supply, 3V or 5V is fine. Use the same voltage that the microcontroller logic is based off of. For most Arduinos, that is 5V
- Connect GND to common power/ data ground
- Connect the SCK pin to Digital #13 but any pin can be used later
- Connect the SDO pin to Digital #12 but any pin can be used later
- Connect the SDI pin to Digital #11 but any pin can be used later
- Connect the CS pin Digital #10 but any pin can be used later

Later on, once we get it working, we can adjust the library to use hardware SPI if you desire, or change the pins to other

Install Adafruit_BME280 library

To begin reading sensor data, you will need to [install the Adafruit_BME280 library \(code on our github repository\) \(https://adafru.it/ffZ\)](https://adafru.it/ffZ). It is available from the Arduino library manager so we recommend using that.

From the IDE open up the library manager...

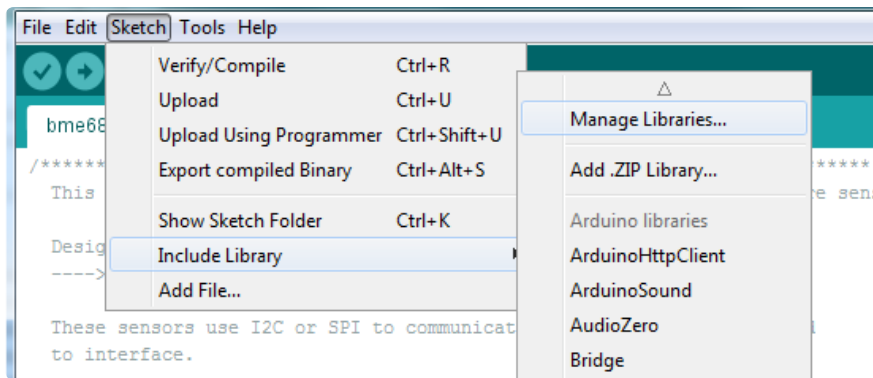

And type in adafruit bme280 to locate the library. Click Install

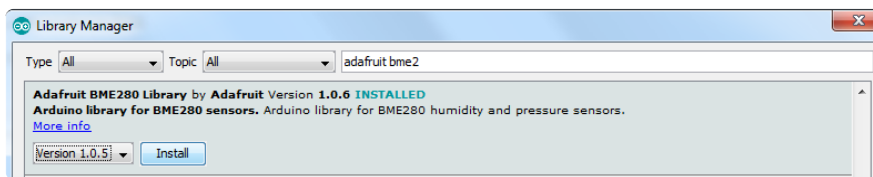

Also add the Adafruit Unified Sensor library

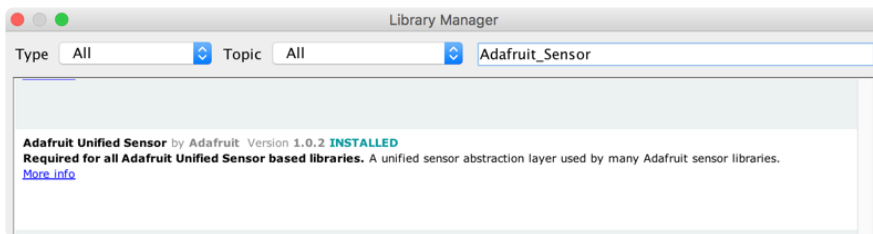

We also have a great tutorial on Arduino library installation at:

<http://learn.adafruit.com/adafruit-all-about-arduino-libraries-install-use> (<https://adafru.it/aYM>)

Load Demo

Open up File->Examples->Adafruit_BME280->bmp280test and upload to your Arduino wired up to the sensor

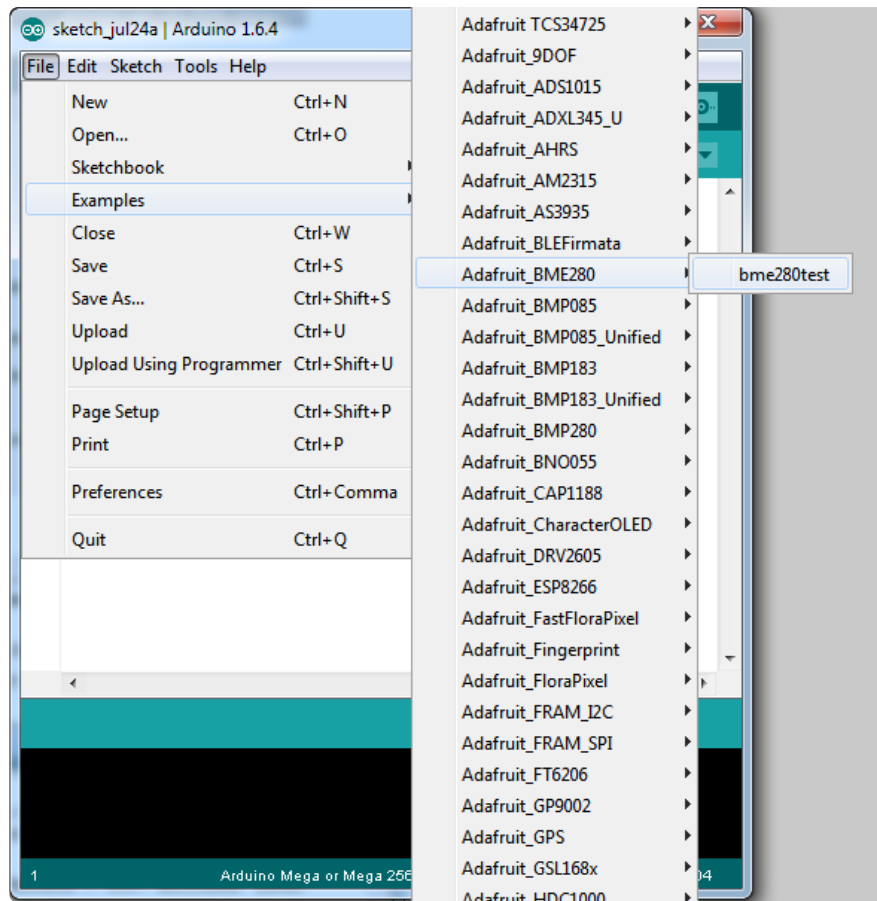

Depending on whether you are using I2C or SPI, change the pin names and comment or uncomment the following lines.

```
#define BME_SCK 13
#define BME_MISO 12
#define BME_MOSI 11
#define BME_CS 10

Adafruit_BME280 bme; // I2C
//Adafruit_BME280 bme(BME_CS); // hardware SPI
//Adafruit_BME280 bme(BME_CS, BME_MOSI, BME_MISO, BME_SCK);
```

Once uploaded to your Arduino, open up the serial console at 9600 baud speed to see data being printed out

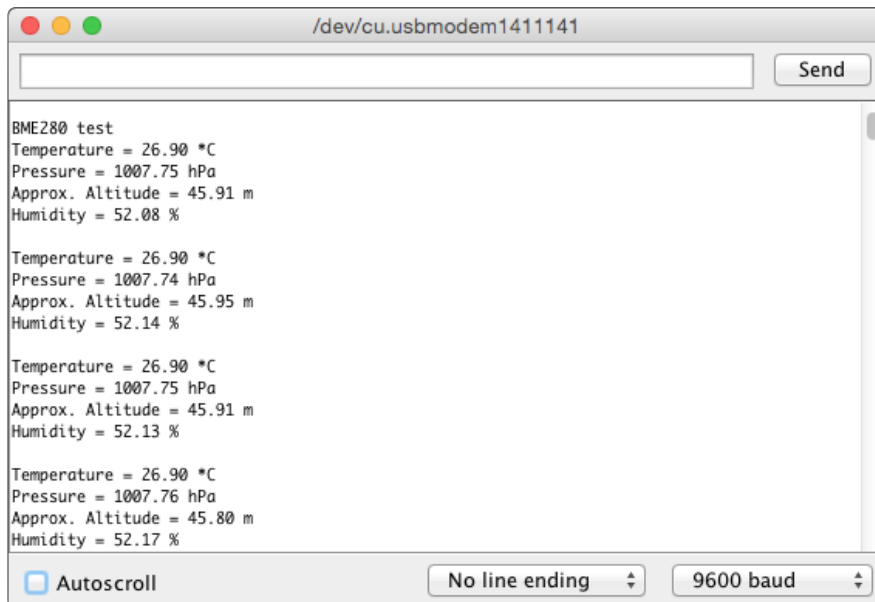

Temperature is calculated in degrees C, you can convert this to F by using the classic $F = C * 9/5 + 32$ equation.

Pressure is returned in the SI units of Pascals. 100 Pascals = 1 hPa = 1 millibar. Often times barometric pressure is reported in millibar or inches-mercury. For future reference 1 pascal = 0.000295333727 inches of mercury, or 1 inch Hg = 3386.39 Pascal. So if you take the pascal value of say 100734 and divide by 3386.39 you'll get 29.72 inches-Hg.

You can also calculate Altitude. However, you can only really do a good accurate job of calculating altitude if you know the hPa pressure at sea level for your location and day! The sensor is quite precise but if you do not have the data updated for the current day then it can be difficult to get more accurate than 10 meters.

Library Reference

You can start out by creating a BME280 object with either software SPI (where all four pins can be any I/O) using

```
Adafruit_BME280 bme(BME_CS, BME_MOSI, BME_MISO, BME_SCK);
```

Or you can use hardware SPI. With hardware SPI you must use the hardware SPI pins for your Arduino - and each arduino type has different pins! [Check the SPI reference to see what pins to use. \(https://adafru.it/d5h\)](https://adafru.it/d5h)

In this case, you can use any CS pin, but the other three pins are fixed

```
Adafruit_BME280 bme(BME_CS); // hardware SPI
```

or I2C using the default I2C bus, no pins are assigned

```
Adafruit_BME280 bme; // I2C
```

Once started, you can initialize the sensor with

```
if (!bme.begin()) {  
  Serial.println("Could not find a valid BME280 sensor, check wiring!");  
  while (1);  
}
```

`begin()` will return `True` if the sensor was found, and `False` if not. If you get a `False` value back, check your wiring!

Reading humidity, temperature and pressure is easy, just call:

```
bme.readTemperature()  
bme.readPressure()  
bme.readHumidity()
```

Temperature is always a floating point, in Centigrade. Pressure is a 32 bit integer with the pressure in Pascals. You may need to convert to a different value to match it with your weather report. Humidity is in % Relative Humidity

It's also possible to turn the BME280 into an altimeter. If you know the pressure at sea level, the library can calculate the current barometric pressure into altitude

```
bmp.readAltitude(seaLevelPressure)
```

However, you can only really do a good accurate job of calculating altitude if you know the hPa pressure at sea level for your location and day! The sensor is quite precise but if you do not have the data updated for the current day then it can be difficult to get more accurate than 10 meters.

Pass in the current sea level pressure in hPa - so the value will be somewhere around ~1000. You can also test with the generic 1013.25 value.

Python & CircuitPython Test

It's easy to use the BME280 sensor with Python or CircuitPython and the [Adafruit CircuitPython BME280 \(https://adafru.it/BfX\)](https://adafru.it/BfX) module. This module allows you to easily write Python code that reads the humidity, temperature, pressure, and more from the sensor.

You can use this sensor with any CircuitPython microcontroller board or with a computer that has GPIO and Python [thanks to Adafruit_Blinka, our CircuitPython-for-Python compatibility library \(https://adafru.it/BSN\)](https://adafru.it/BSN).

CircuitPython Microcontroller Wiring

First wire up a BME280 to your board exactly as shown on the previous pages for Arduino. You can use either I2C or SPI wiring, although it's recommended to use I2C for simplicity. Here's an example of wiring a Feather M0 to the sensor with I2C:

- Board 3V to sensor VIN
- Board GND to sensor GND
- Board SCL to sensor SCK
- Board SDA to sensor SDI

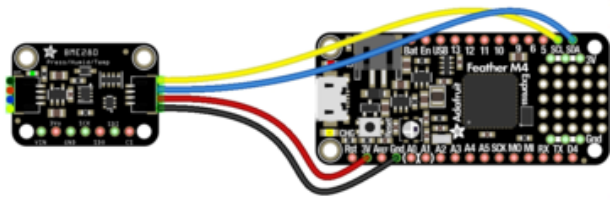

fritzing

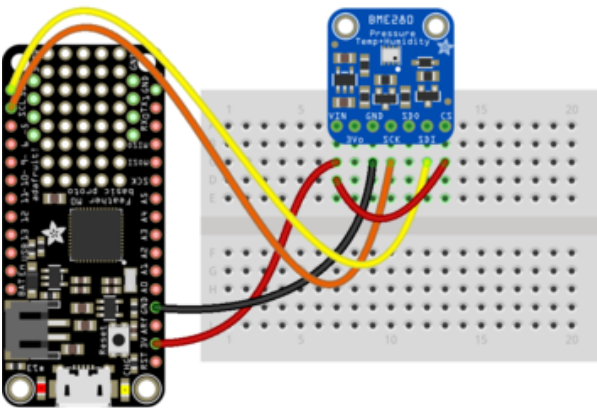
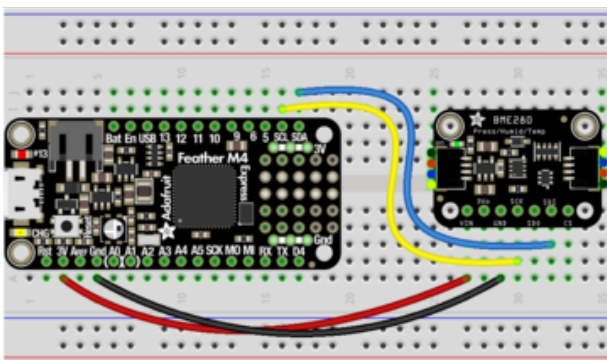

fritzing

And an example of a Feather M0 wired with hardware SPI:

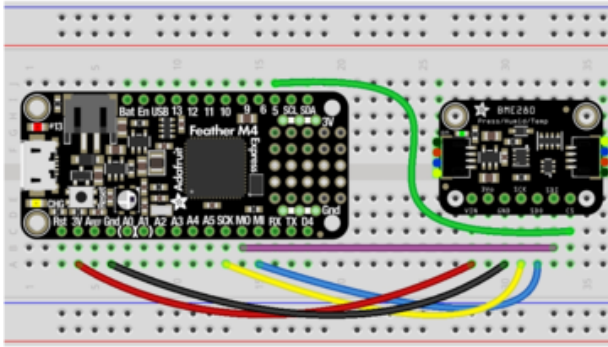

- Board 3V to sensor VIN
- Board GND to sensor GND
- Board SCK to sensor SCK
- Board MOSI to sensor SDI
- Board MISO to sensor SDO
- Board D5 to sensor CS (or use any other free digital I/O pin)

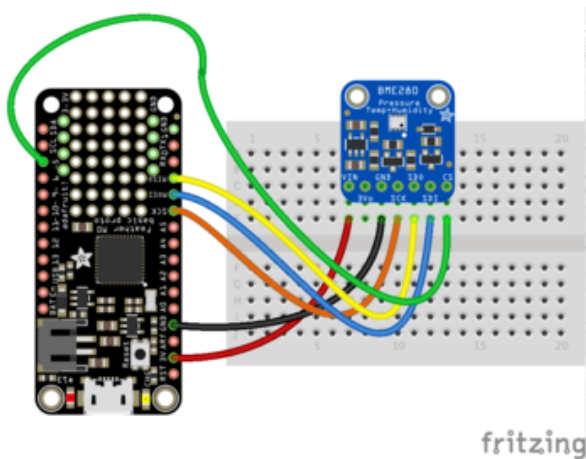

Python Computer Wiring

Since there's dozens of Linux computers/boards you can use we will show wiring for Raspberry Pi. For other platforms, [please visit the guide for CircuitPython on Linux to see whether your platform is supported \(https://adafru.it/BSN\)](https://adafru.it/BSN).

Here's the Raspberry Pi wired with I2C:

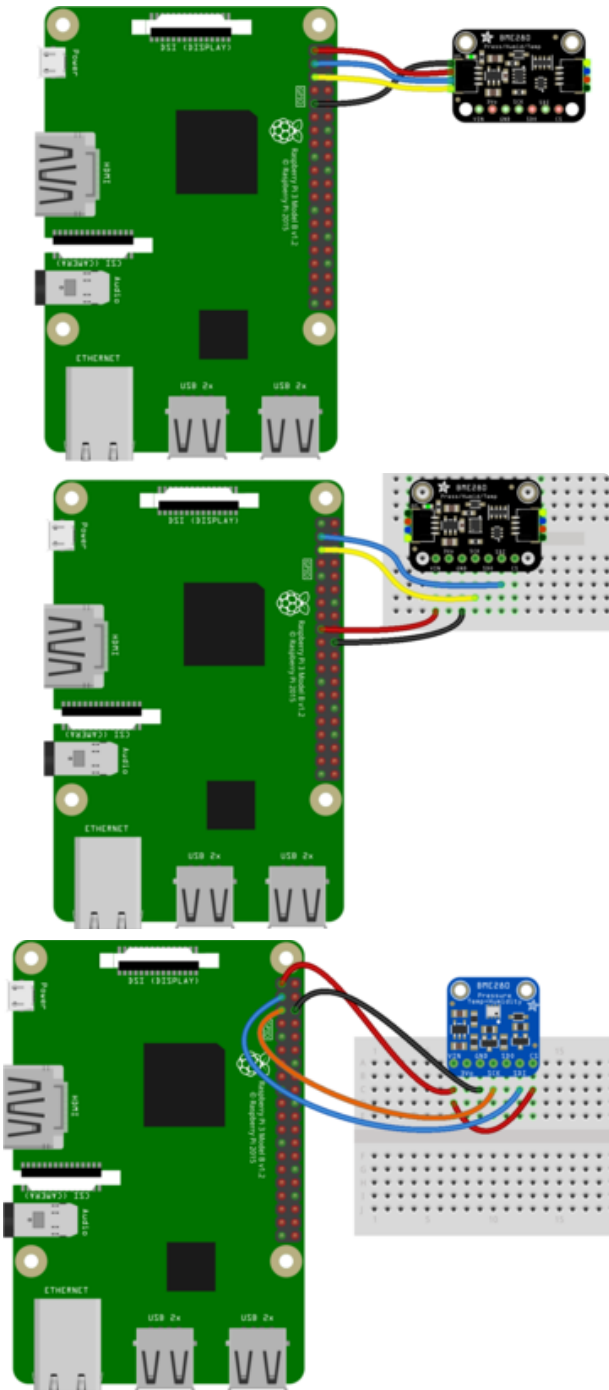

- Pi 3V3 to sensor VIN
- Pi GND to sensor GND
- Pi SCL to sensor SCK
- Pi SDA to sensor SDI

And an example on the Raspberry Pi 3 Model B wired with SPI:

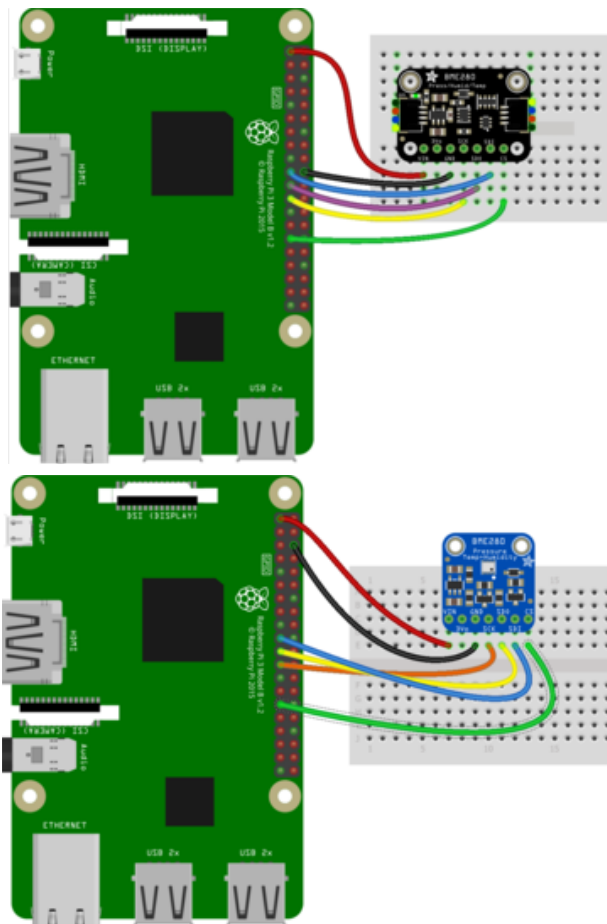

- Pi 3V3 to sensor VIN
- Pi GND to sensor GND
- Pi MOSI to sensor SDI
- Pi MISO to sensor SDO
- Pi SCLK to sensor SCK
- Pi #5 to sensor CS (or use any other free GPIO pin)

CircuitPython Installation of BME280 Library

You'll need to install the [Adafruit CircuitPython BME280 \(https://adafru.it/BfX\)](https://adafru.it/BfX) library on your CircuitPython board.

First make sure you are running the [latest version of Adafruit CircuitPython \(https://adafru.it/Amd\)](https://adafru.it/Amd) for your board.

Next you'll need to install the necessary libraries to use the hardware--carefully follow the steps to find and install these libraries from [Adafruit's CircuitPython library bundle \(https://adafru.it/uap\)](https://adafru.it/uap). Our CircuitPython starter guide has [a great page on how to install the library bundle \(https://adafru.it/ABU\)](https://adafru.it/ABU).

Before continuing make sure your board's lib folder or root filesystem has the adafruit_bme280, and adafruit_bus_device folders copied over. Both of these are folders with library files in them. Make sure to copy the whole folder for both into your lib folder!

Next [connect to the board's serial REPL \(https://adafru.it/Awz\)](https://adafru.it/Awz) so you are at the CircuitPython >>> prompt.

Python Installation of BME280 Library

You'll need to install the Adafruit_Blinka library that provides the CircuitPython support in Python. This may also require enabling I2C on your platform and verifying you are running Python 3. [Since each platform is a little different, and Linux changes often, please visit the CircuitPython on Linux guide to get your computer ready \(https://adafru.it/BSN\)](https://adafru.it/BSN)!

Once that's done, from your command line run the following command:

- `sudo pip3 install adafruit-circuitpython-bme280`

If your default Python is version 3 you may need to run 'pip' instead. Just make sure you aren't trying to use CircuitPython on Python 2.x, it isn't supported!

CircuitPython & Python Usage

To demonstrate the usage of the sensor we'll initialize it and read the temperature, humidity, and more from the board's Python REPL.

If you're using an I2C connection run the following code to import the necessary modules and initialize the I2C connection with the sensor:

```
import board
from adafruit_bme280 import basic as adafruit_bme280
i2c = board.I2C() # uses board.SCL and board.SDA
bme280 = adafruit_bme280.Adafruit_BME280_I2C(i2c)
```

Or if you're using a SPI connection run this code instead to setup the SPI connection and sensor:

```
import board
import digitalio
from adafruit_bme280 import basic as adafruit_bme280
spi = board.SPI()
cs = digitalio.DigitalInOut(board.D5)
bme280 = adafruit_bme280.Adafruit_BME280_SPI(spi, cs)
```

Now you're ready to read values from the sensor using any of these properties:

- temperature - The sensor temperature in degrees Celsius.
- humidity - The percent humidity as a value from 0 to 100%.
- pressure - The pressure in hPa.
- altitude - The altitude in meters.

For example to print temperature, humidity, and pressure:

```
print("\nTemperature: %0.1f C" % bme280.temperature)
print("Humidity: %0.1f %" % bme280.humidity)
print("Pressure: %0.1f hPa" % bme280.pressure)
```

```
>>> print("Temperature: %0.1f C" % bme280.temperature)
Temperature: 22.0 C
>>> print("Humidity: %0.1f %" % bme280.humidity)
Humidity: 35.9 %
>>> print("Pressure: %0.1f hPa" % bme280.pressure)
Pressure: 1007.7 hPa
>>>
```

For altitude you'll want to set the pressure at sea level for your location to get the most accurate measure (remember these sensors can only infer altitude based on pressure and need a set calibration point). Look at your local weather report for a pressure at sea level reading and set the `sea_level_pressure` property:

```
bme280.sea_level_pressure = 1013.4
```

Then read the altitude property for a more accurate altitude reading (but remember this altitude will fluctuate based on atmospheric pressure changes!):

```
print("Altitude = %0.2f meters" % bme280.altitude)
```

```
>>> bme280.sea_level_pressure = 1013.25
>>> print("Altitude = %0.2f meters" % bme280.altitude)
Altitude = 47.14 meters
```

You can use the BME280 temperature and humidity to calculate the dew point using the [Magnus formula \(https://adafru.it/C7u\)](https://adafru.it/C7u)! For this example, you'll need to `import` an additional library: `math`. Run the following code:

```
import math
b = 17.62
c = 243.12
gamma = (b * bme280.temperature / (c + bme280.temperature)) +
math.log(bme280.humidity / 100.0)
dewpoint = (c * gamma) / (b - gamma)
print(dewpoint)
```

That's all there is to using the BME280 sensor with CircuitPython!

Full Example Code

```
# SPDX-FileCopyrightText: 2021 ladyada for Adafruit Industries
# SPDX-License-Identifier: MIT

import time
import board
from adafruit_bme280 import basic as adafruit_bme280

# Create sensor object, using the board's default I2C bus.
i2c = board.I2C() # uses board.SCL and board.SDA
bme280 = adafruit_bme280.Adafruit_BME280_I2C(i2c)

# OR create sensor object, using the board's default SPI bus.
# spi = board.SPI()
# bme_cs = digitalio.DigitalInOut(board.D10)
# bme280 = adafruit_bme280.Adafruit_BME280_SPI(spi, bme_cs)

# change this to match the location's pressure (hPa) at sea level
bme280.sea_level_pressure = 1013.25

while True:
    print("\nTemperature: %0.1f C" % bme280.temperature)
    print("Humidity: %0.1f %" % bme280.relative_humidity)
    print("Pressure: %0.1f hPa" % bme280.pressure)
    print("Altitude = %0.2f meters" % bme280.altitude)
    time.sleep(2)
```

Python Docs

[Python Docs \(https://adafru.it/BK2\)](https://adafru.it/BK2)

F.A.Q.

How come the altitude calculation is wrong? Is my sensor broken?

No, your sensor is likely just fine. The altitude calculation depends on knowing the barometric pressure at sea level

If you do not set the correct sea level pressure for your location FOR THE CURRENT DAY it will not be able to calculate the altitude accurately

Barometric pressure at sea level changes daily based on the weather!

If I have long delays between reads, the first data read seems wrong?

The BMx280 'saves' the last reading in memory for you to query. Just read twice in a row and toss out the first reading!

Downloads

Documents

- [Datasheet for the BME280 sensor used in this breakout \(https://adafru.it/fG0\)](https://adafru.it/fG0)
- [Arduino BME280 Driver \(https://adafru.it/fFZ\)](https://adafru.it/fFZ)
- [Fritzing object in the Adafruit Fritzing Library \(https://adafru.it/aP3\)](https://adafru.it/aP3)
- [EagleCAD PCB files on GitHub \(original, non QT version\) \(https://adafru.it/rCW\)](https://adafru.it/rCW)
- [EagleCAD PCB files for QT version, which is the same exact PCB as the BMP280 \(https://adafru.it/rDq\)\(sensors are pin/size compatible\)](https://adafru.it/rDq)
- [K&R Smith calibration notes \(https://adafru.it/BfU\)](https://adafru.it/BfU)

Alternative Driver (Python)

If you are using this breakout with a Raspberry Pi or Pi2, you can also look at the [Adafruit_Python_BME280 \(https://adafru.it/fX4\)](https://adafru.it/fX4) driver.

This alternative driver uses I2C to communicate with the BME280, so connect SCL on the Pi to SCK on the BME, and SDA to SDI, along with power (3.3V to VIN) and GND.

Schematic and Fab Print for STEMMMA QT Version

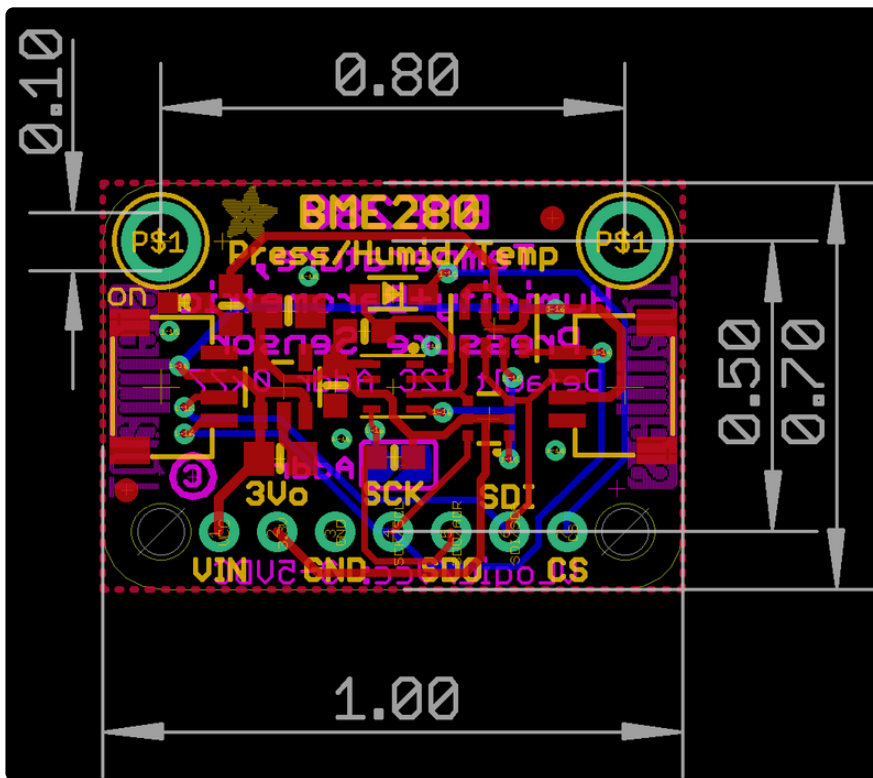
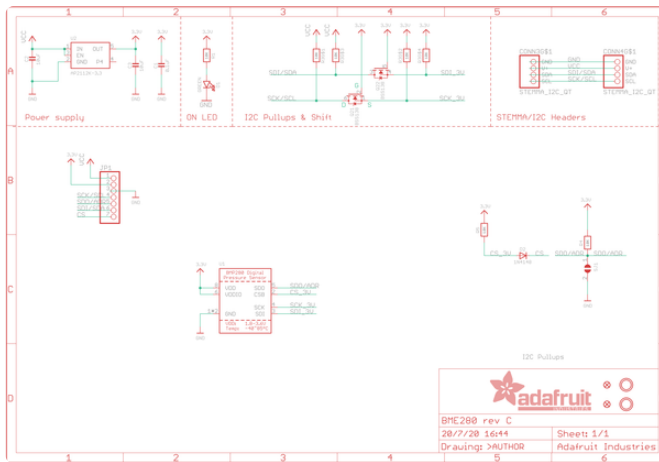

Schematic and Fab Print for Original Version

[Click to enlarge](#)

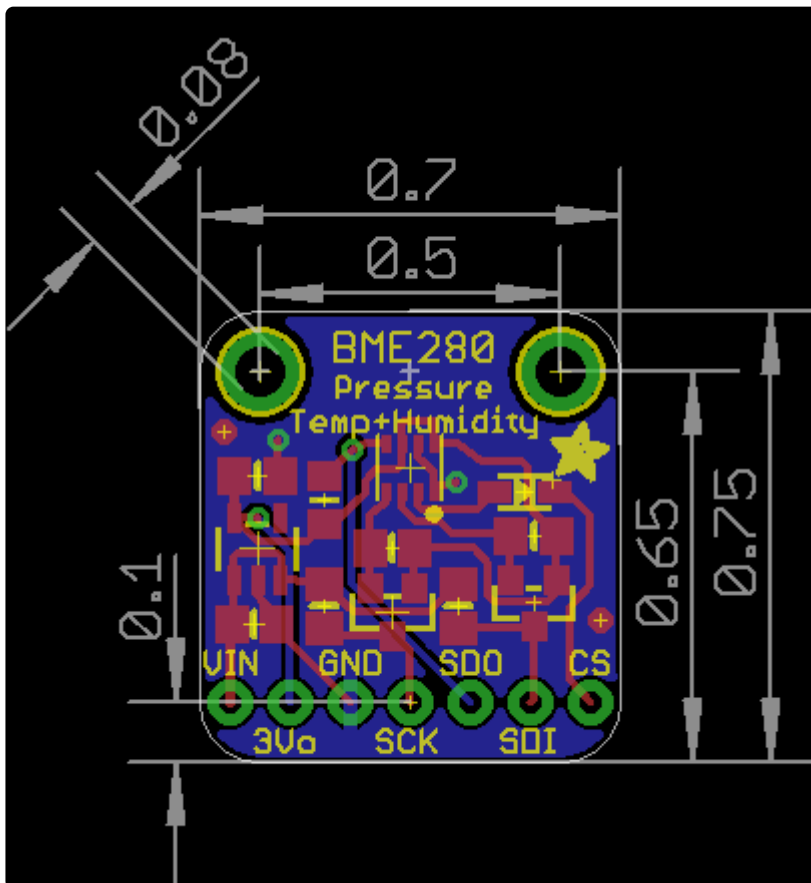
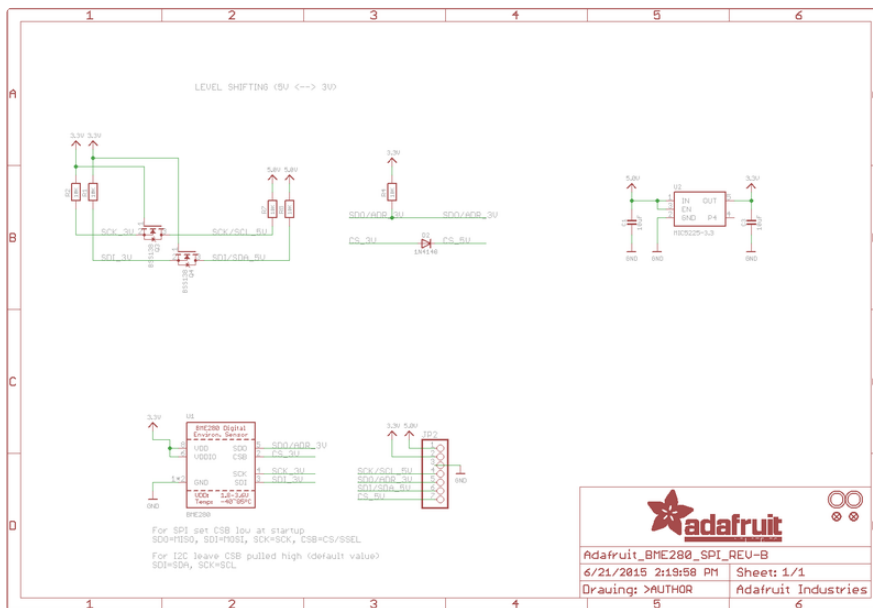

Mouser Electronics

Authorized Distributor

Click to View Pricing, Inventory, Delivery & Lifecycle Information:

[Adafruit:](#)

[2652](#)