

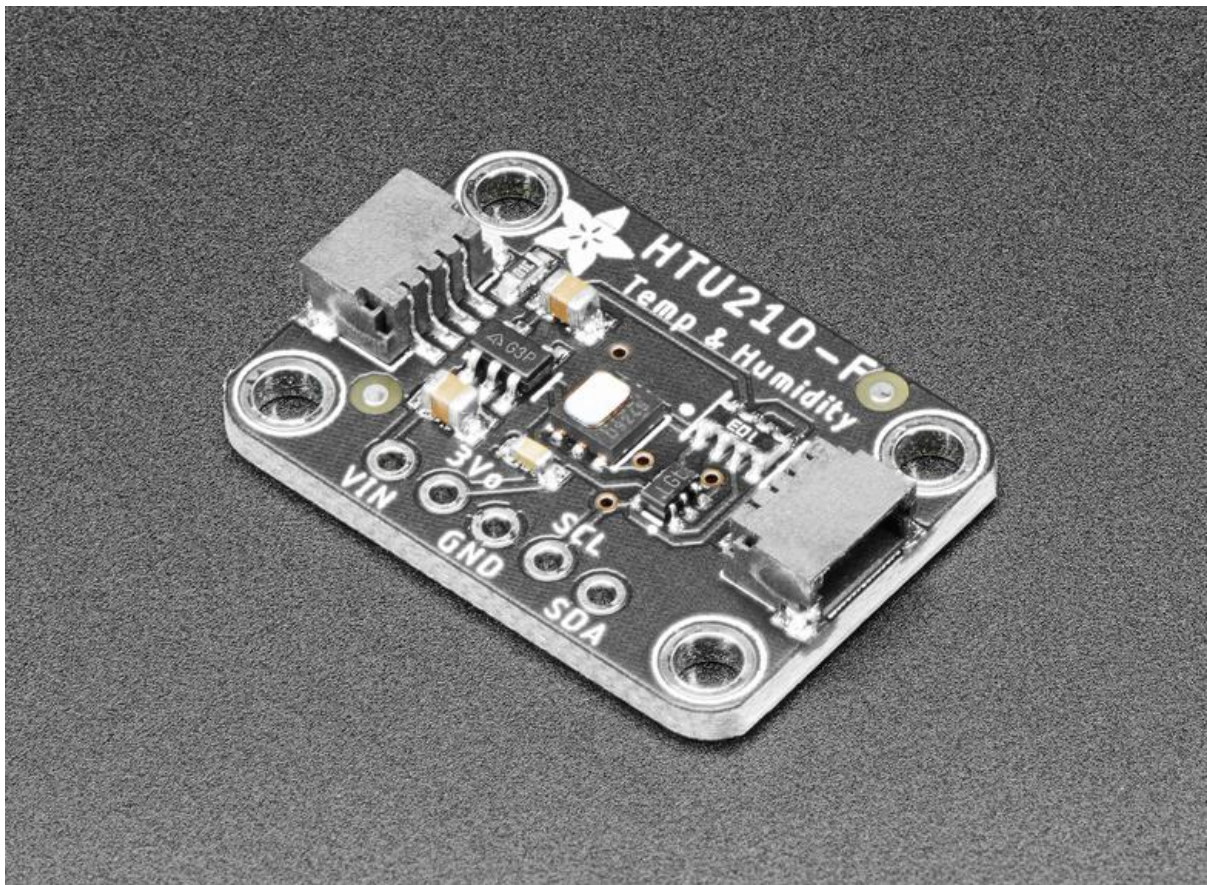

# Adafruit HTU21D-F Temperature & Humidity Sensor

Created by lady ada



<https://learn.adafruit.com/adafruit-htu21d-f-temperature-humidity-sensor>

Last updated on 2021-11-15 06:13:47 PM EST

# Table of Contents

Overview	3
Pinouts	5
• Power Pins:	6
• I2C Logic pins:	7
Assembly	7
• Prepare the header strip:	7
• Add the breakout board:	8
• And Solder!	8
Wiring & Test	9
• Download Adafruit_HTU21DF	10
• Load Demo	11
• Library Reference	12
Python & CircuitPython	13
• CircuitPython MicroController Wiring	13
• Python Computer Wiring	14
• CircuitPython Installation of HTU21D Library	15
• Python Installation of HTU21D Library	16
• CircuitPython & Python Usage	16
• Full Example Code	17
Python Docs	18
Downloads	18
• Files & Datasheets	18
• Schematic and Fab Print for STEMMA QT Version	18
• Schematic and Fab Print for Original Version	19

---

# Overview

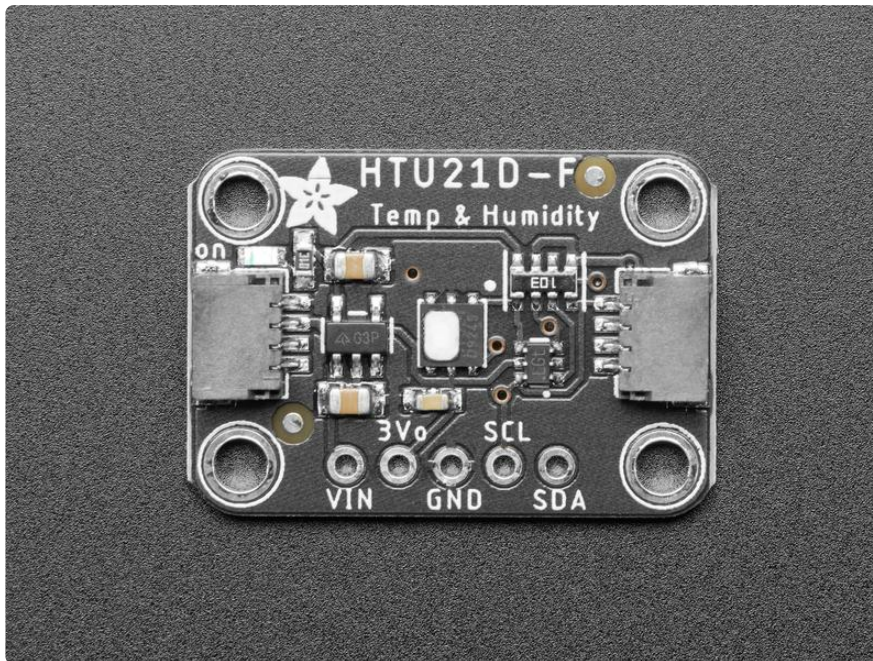

It's summer and you're sweating and your hair's all frizzy and all you really want to know is why the weatherman said this morning that today's relative humidity would max out at a perfectly reasonable 52% when it feels more like 77%. Enter the HTU21D-F Temperature + Humidity Sensor - the best way to prove the weatherman wrong!

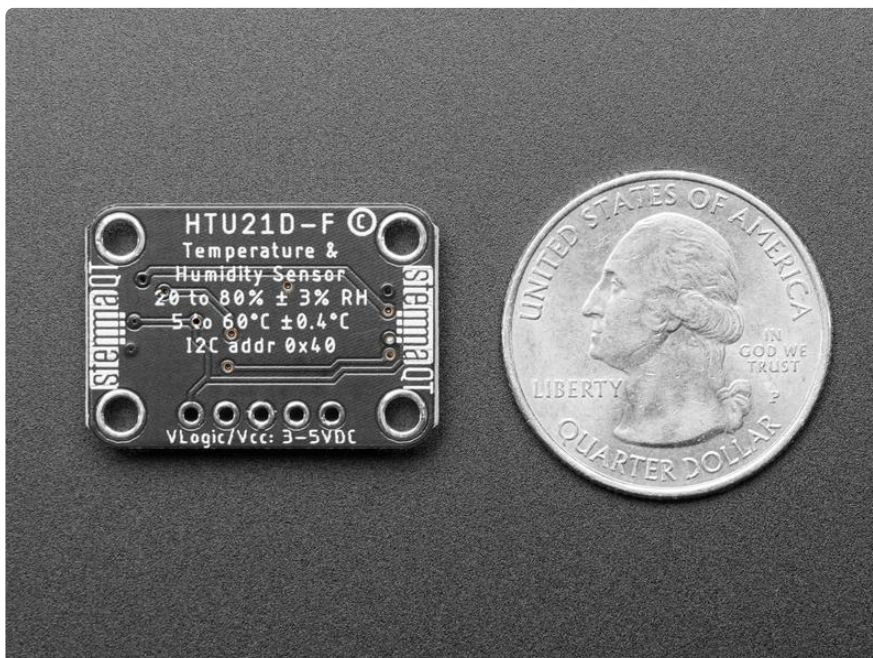

This I2C digital humidity sensor is an accurate and intelligent alternative to the much simpler [Humidity and Temperature Sensor - SHT15 Breakout](http://adafru.it/1638) (<http://adafru.it/1638>) It has a typical accuracy of  $\pm 2\%$  with an operating range that's optimized from 5% to 95% RH. Operation outside this range is still possible - just the accuracy might drop a

bit. The temperature output has an accuracy of  $\pm 1^{\circ}\text{C}$  from  $-30^{\circ}\text{C}$  to  $90^{\circ}\text{C}$ . If you're looking to measure temperature more accurately, we recommend the [MCP9808 High Accuracy I2C Temperature Sensor Breakout Board](http://adafru.it/1782). (<http://adafru.it/1782>)

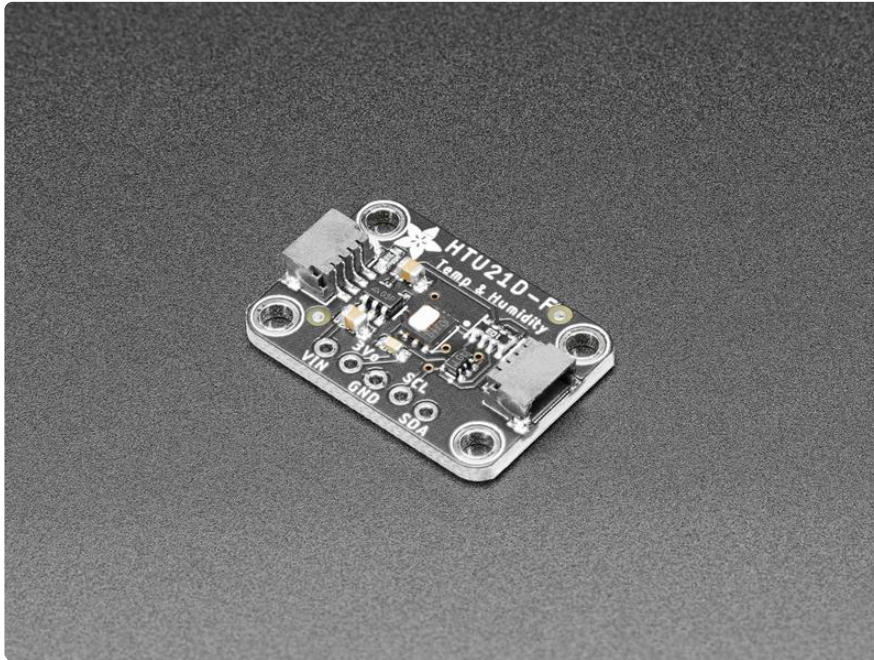

Such a lovely chip - so we spun up a breakout board that includes the Filtered version (the white bit of plastic which is a PTFE filter to keep the sensor clean), a 3.3V regulator and I2C level shifting circuitry. This lets you use it safely with any kind of microcontroller with 3.3V-5V power or logic.

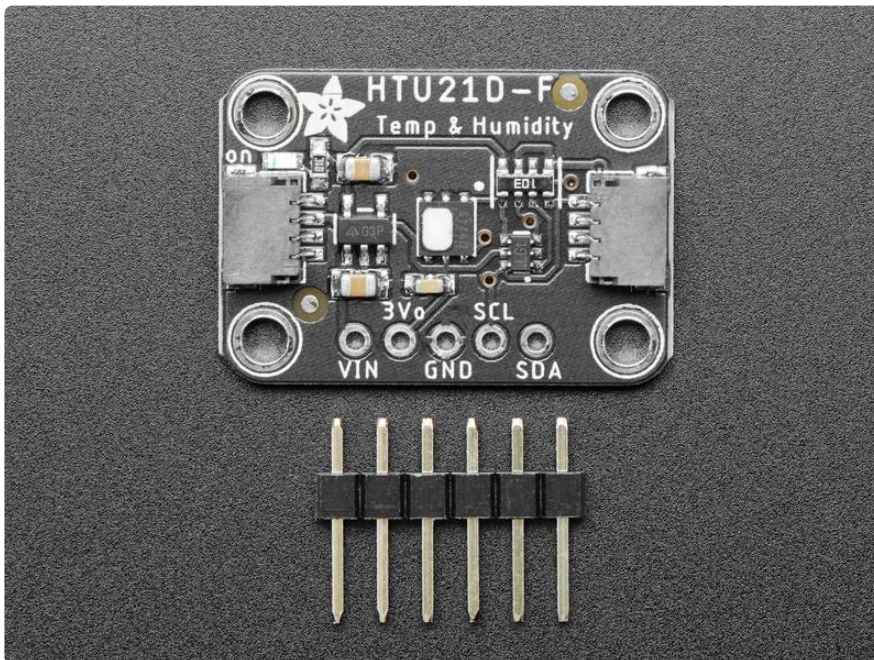

To get you going fast, we spun up a custom made PCB in the [STEMMA QT form factor](https://adafru.it/LBQ) (<https://adafru.it/LBQ>), making them easy to interface with. The [STEMMA QT](#)

[connectors \(https://adafru.it/JqB\)](https://adafru.it/JqB) on either side are compatible with the [SparkFun Qwiic \(https://adafru.it/Fpw\)](https://adafru.it/Fpw) I2C connectors. This allows you to make solderless connections between your development board and the HTU21Ds or to chain them with a wide range of other sensors and accessories using a [compatible cable \(https://adafru.it/JnB\)](https://adafru.it/JnB). [QT Cable is not included, but we have a variety in the shop \(https://adafru.it/JnB\)](https://adafru.it/JnB).

Each order comes with one fully assembled and tested PCB breakout and a small piece of header. You'll need to solder the header onto the PCB but it's fairly easy and takes only a few minutes even for a beginner.

There are two versions of this board - the STEMMA QT version shown above, and the original header-only version shown below. Code works the same on both!

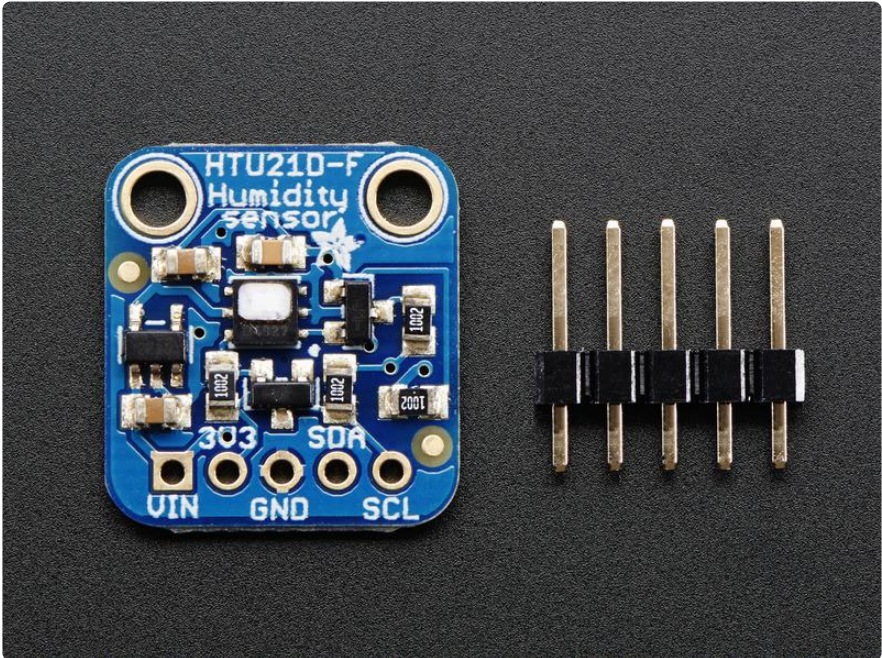

## Pinouts

The HTU21D-F is a I2C sensor. That means it uses the two I2C data/clock wires available on most microcontrollers, and can share those pins with other sensors as long as they don't have an address collision. For future reference, the I2C address is 0x40 and you can't change it!

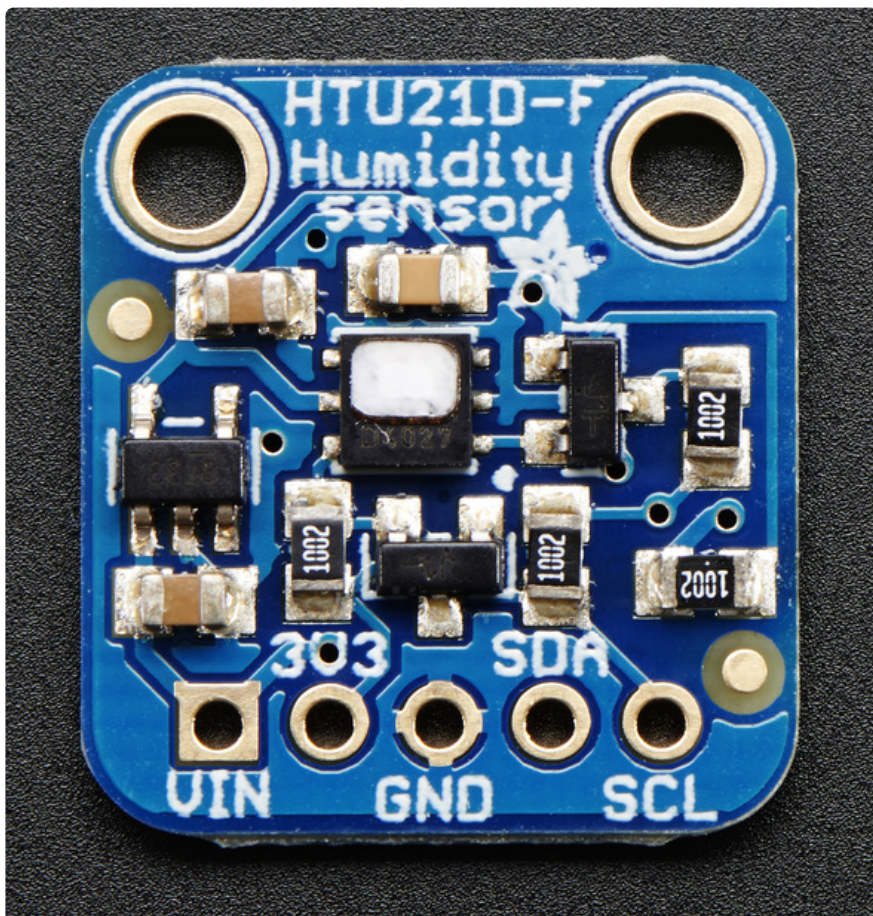
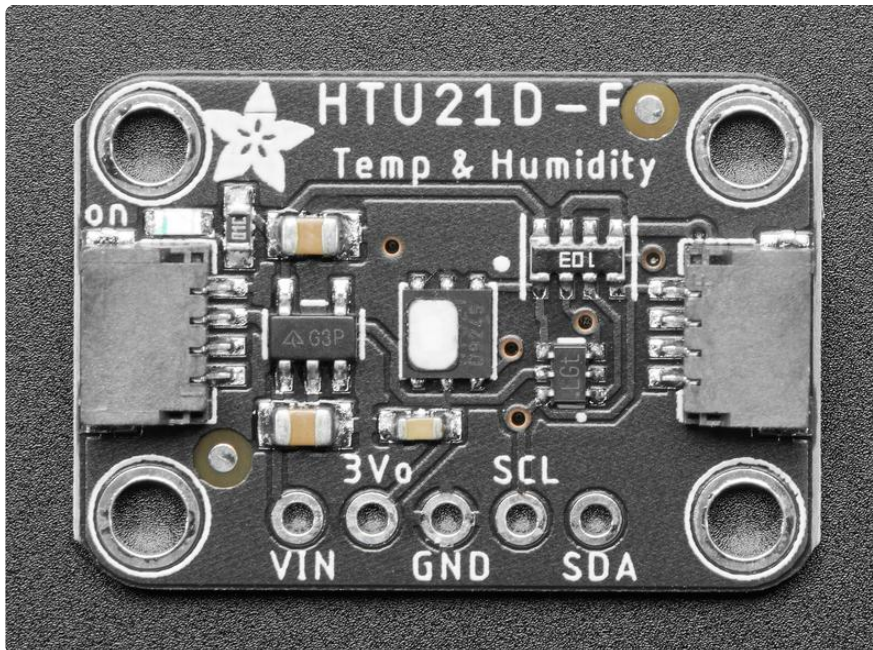

## Power Pins:

- Vin - this is the power pin. Since the chip uses 3 VDC, we have included a voltage regulator on board that will take 3-5VDC and safely convert it down. To power the board, give it the same power as the logic level of your microcontroller - e.g. for a 5V micro like Arduino, use 5V

- 3Vo (3v3 on original version) - this is the 3.3V output from the voltage regulator, you can grab up to 100mA from this if you like
- GND - common ground for power and logic

## I2C Logic pins:

- SCL - I2C clock pin, connect to your microcontrollers I2C clock line.
- SDA - I2C data pin, connect to your microcontrollers I2C data line.
- [STEMMA QT \(https://adafru.it/Ft4\)](https://adafru.it/Ft4) - These connectors allow you to connect to development boards with STEMMA QT connectors, or to other things, with [various associated accessories \(https://adafru.it/Ft6\)](https://adafru.it/Ft6).

---

## Assembly

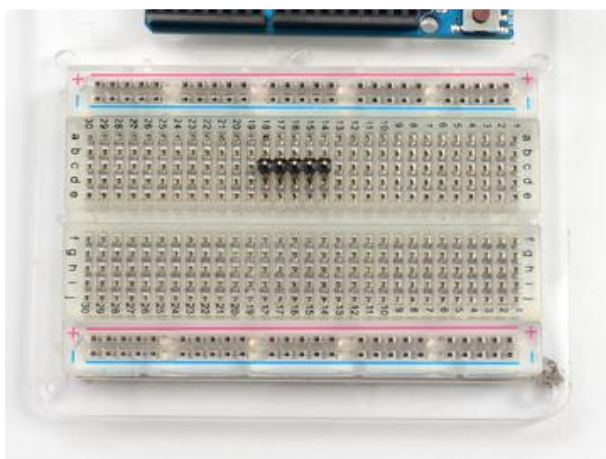
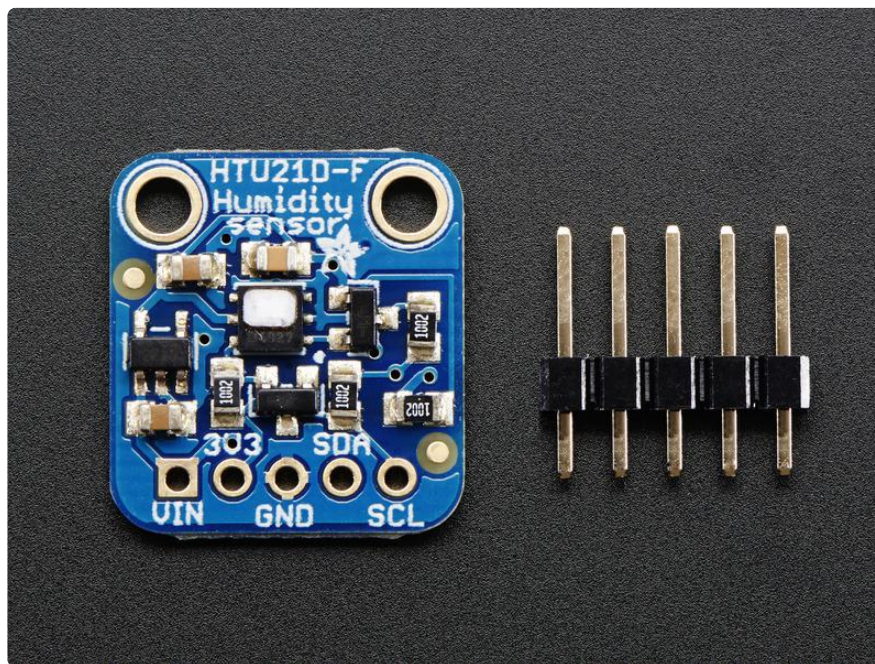

### Prepare the header strip:

Cut the strip to length if necessary. It will be easier to solder if you insert it into a breadboard - long pins down

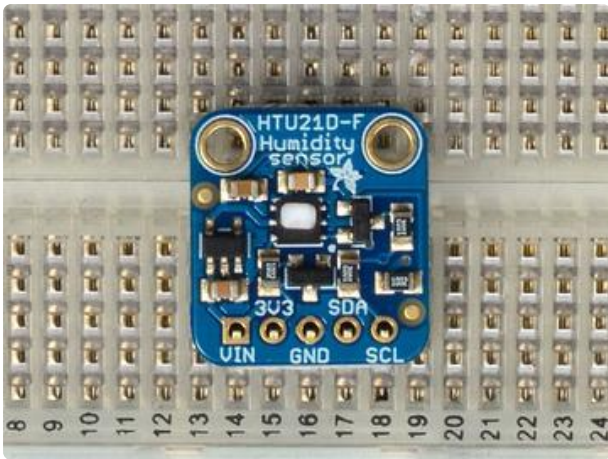

## Add the breakout board:

Place the breakout board over the pins so that the short pins poke through the breakout pads

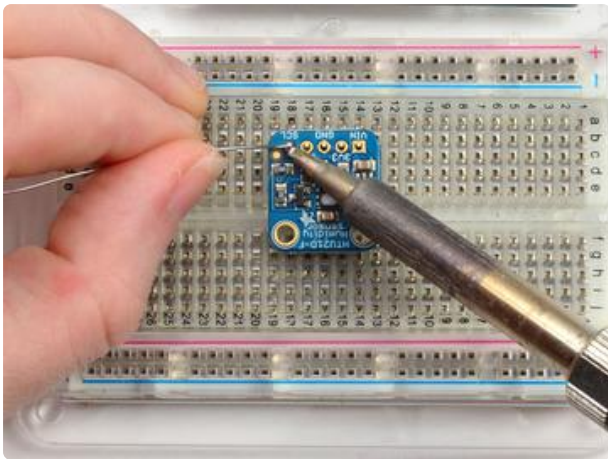

## And Solder!

Be sure to solder all pins for reliable electrical contact.

(For tips on soldering, be sure to check out our [Guide to Excellent Soldering](https://adafruit.it/aTk) (<https://adafruit.it/aTk>)).

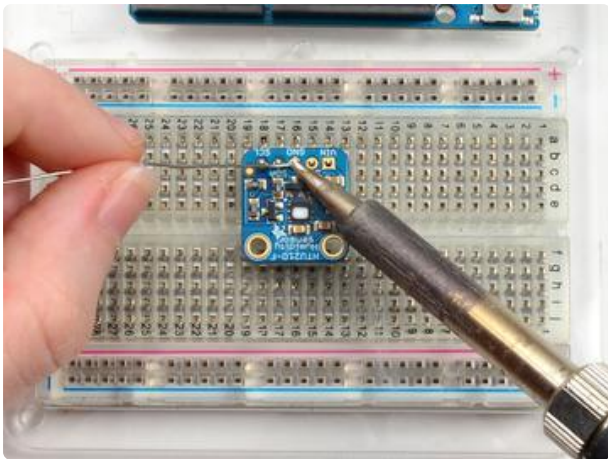





You're done! Check your solder joints visually and continue onto the next steps

---

## Wiring & Test

You can easily wire this breakout to any microcontroller, we'll be using an Arduino. For another kind of microcontroller, just make sure it has I2C, then port the code - its pretty simple stuff!

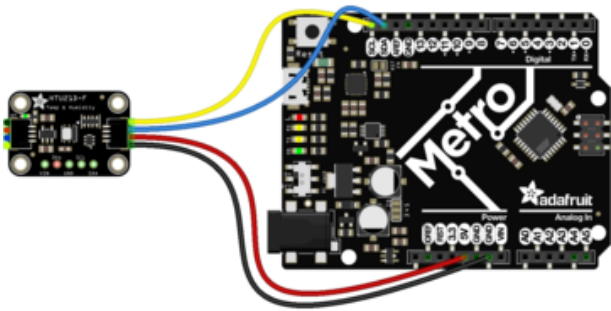

fritzing

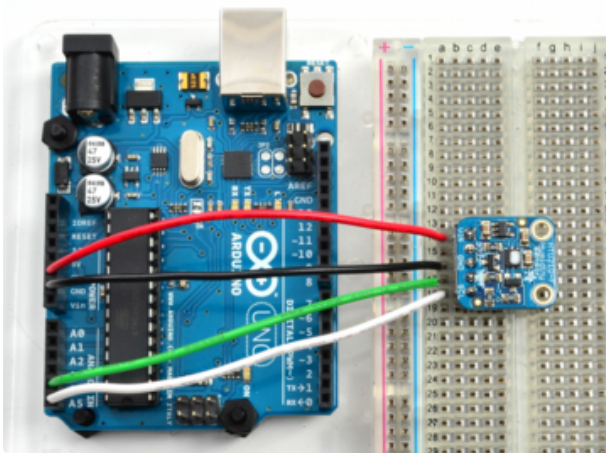
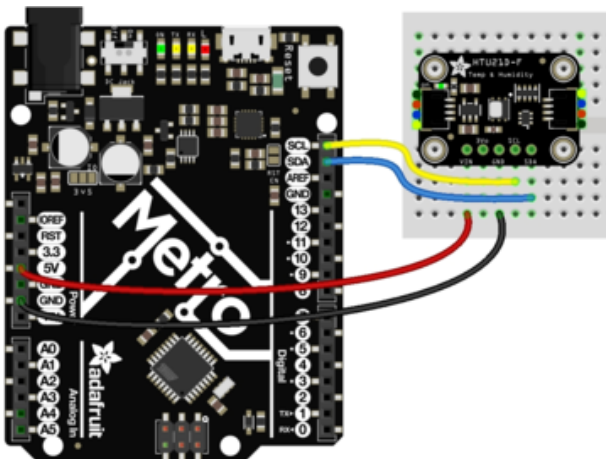

- Connect Vin to the power supply, 3-5V is fine. (red wire on STEMMA QT version) Use the same voltage that the microcontroller logic is based off of. For most Arduinos, that is 5V
- Connect GND to common power/ data ground (black wire on STEMMA QT version)
- Connect the SCL pin to the I2C clock SCL pin on your Arduino. (yellow wire on STEMMA QT version) On an UNO & '328 based Arduino, this is also known as A5, on a Mega it is also known as digital 21 and on a Leonardo/Micro, digital 3
- Connect the SDA pin to the I2C data SDA pin on your Arduino. (blue wire on STEMMA QT version) On an UNO & '328 based Arduino, this is also known as A4, on a Mega it is also known as digital 20 and on a Leonardo/Micro, digital 2

The HTU21D-F has a default I2C address of 0x40 and cannot be changed!

## Download Adafruit\_HTU21DF

To begin reading sensor data, you will need to download the Adafruit HTU21DF library from the Arduino library manager.

Open up the Arduino library manager:

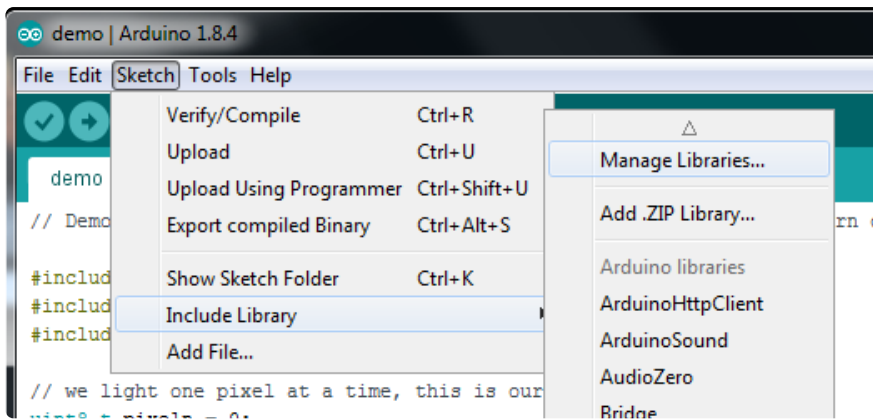

Search for the Adafruit HTU21DF library and install it



We also have a great tutorial on Arduino library installation at:

<http://learn.adafruit.com/adafruit-all-about-arduino-libraries-install-use> (<https://adafru.it/aYM>)

## Load Demo

Open up File->Examples->Adafruit\_HTU21DF->HTU21DFtest and upload to your Arduino wired up to the sensor

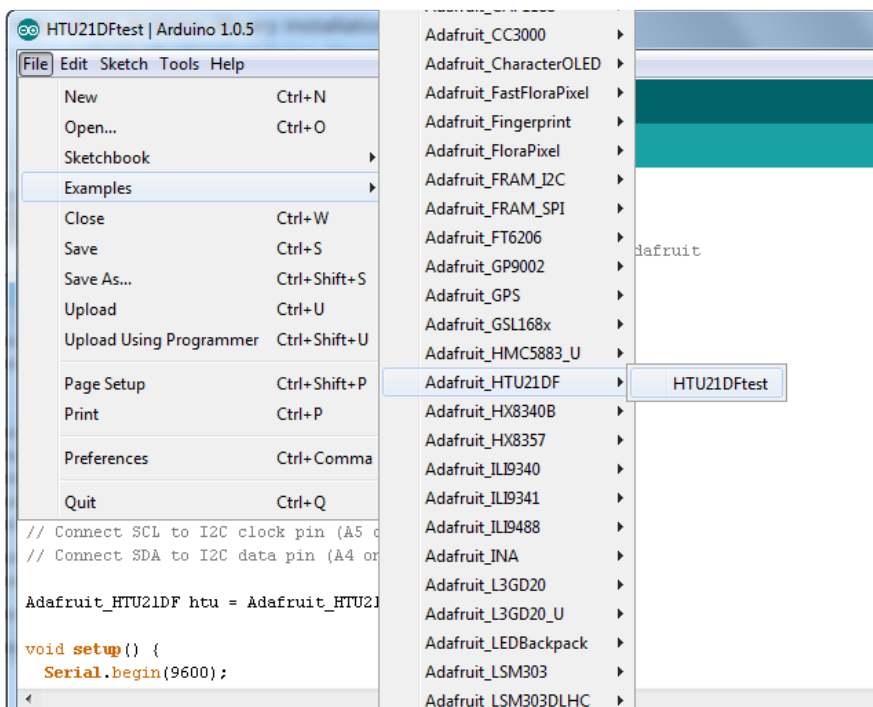

That's it! Now open up the serial terminal window at 9600 speed to begin the test.

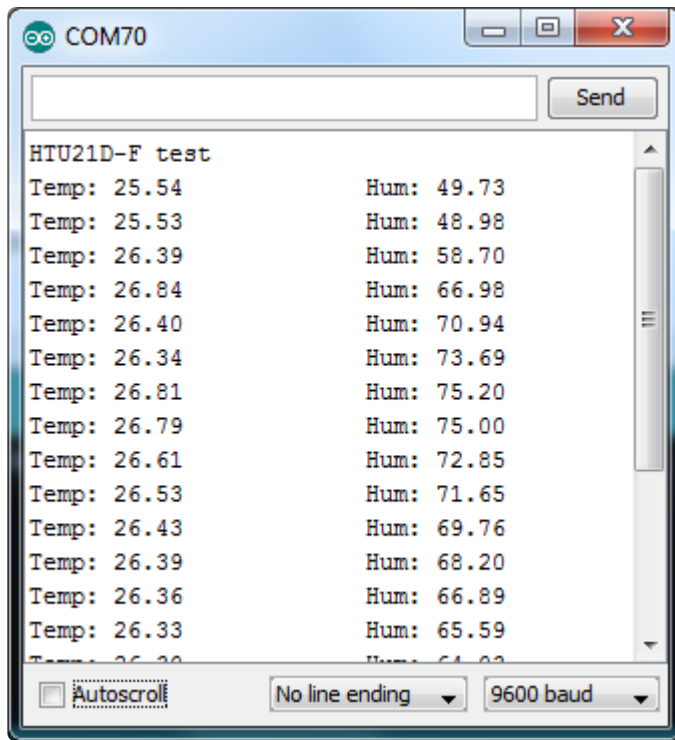

You can try breathing on the sensor to increase the humidity. The sensor reacts very fast!

## Library Reference

The library we have is simple and easy to use

You can create the `Adafruit_HTU21DF` object with:

```
Adafruit_HTU21DF htu = Adafruit_HTU21DF()
```

There are no pins to set since you must use the I2C bus!

Then initialize the sensor with:

```
htu.begin()
```

this function returns `True` if the sensor was found and responded correctly and `False` if it was not found

Once initialized, you can query the temperature in °C with

```
htu.readTemperature()
```

Which will return floating point (decimal + fractional) temperature. You can convert to Fahrenheit by multiplying by 1.8 and adding 32 as you have learned in grade school!

Reading the humidity is equally simple. Call

```
htu.readHumidity()
```

to read the humidity also as a floating point value between 0 and 100 (this reads % humidity)

---

## Python & CircuitPython

It's easy to use the HTU21D-F sensor with Python or CircuitPython and the [Adafruit CircuitPython HTU21D \(https://adafru.it/CDn\)](https://adafru.it/CDn) module. This module allows you to easily write Python code that reads the humidity and temperature from the sensor.

You can use this sensor with any CircuitPython microcontroller board or with a computer that has GPIO and Python [thanks to Adafruit\\_Blinka, our CircuitPython-for-Python compatibility library \(https://adafru.it/BSN\)](https://adafru.it/BSN).

## CircuitPython MicroController Wiring

First wire up a HTU21D-F to your board exactly as shown on the previous pages for Arduino. Here's an example of wiring a Feather M0 Express to the sensor with I2C:

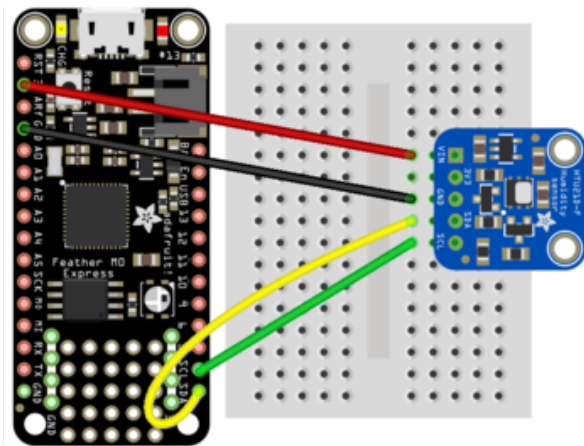

- Board 3V3 to sensor VIN (red wire on STEMMA QT version)
- Board GND to sensor GND (black wire on STEMMA QT version)
- Board SCL to sensor SCL (yellow wire on STEMMA QT version)
- Board SDA to sensor SDA (blue wire on STEMMA QT version)

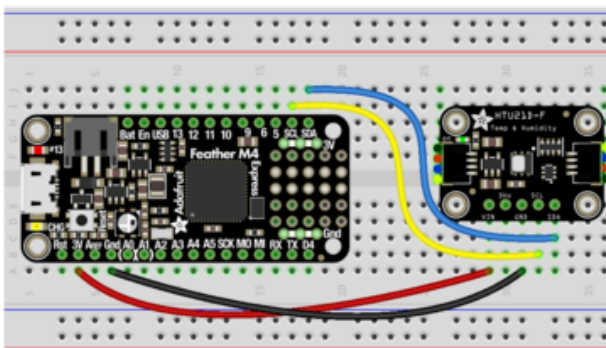
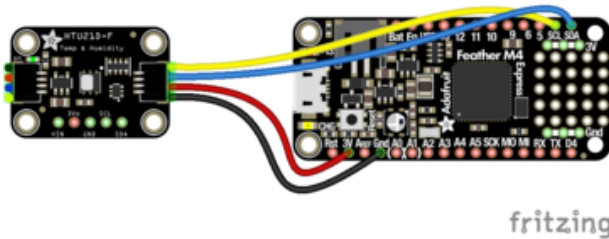

## Python Computer Wiring

Since there's dozens of Linux computers/boards you can use we will show wiring for Raspberry Pi. For other platforms, [please visit the guide for CircuitPython on Linux to see whether your platform is supported \(https://adafruit.it/BSN\)](https://adafruit.it/BSN).

Here's the Raspberry Pi wired with I2C:

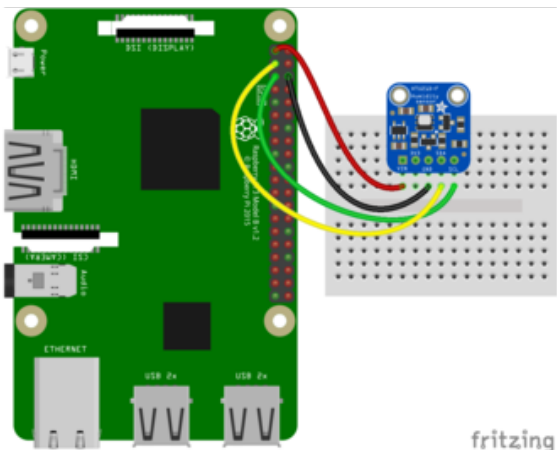

- Pi GND to sensor GND (black wire on STEMMA QT version)
- Pi 3V3 to sensor VIN (red wire on STEMMA QT version)
- Pi SDA to sensor SDA (blue wire on STEMMA QT version)
- Pi SCL to sensor SCL (yellow wire on STEMMA QT version)

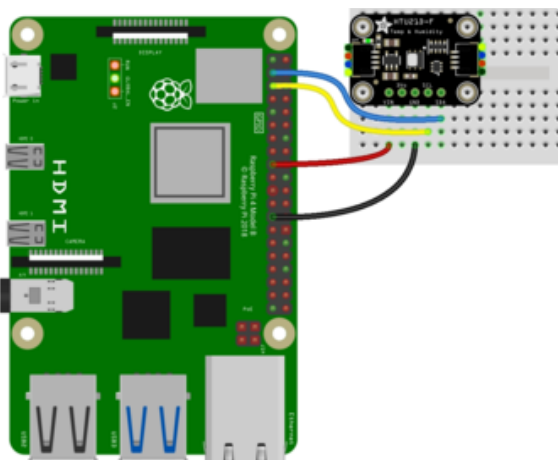
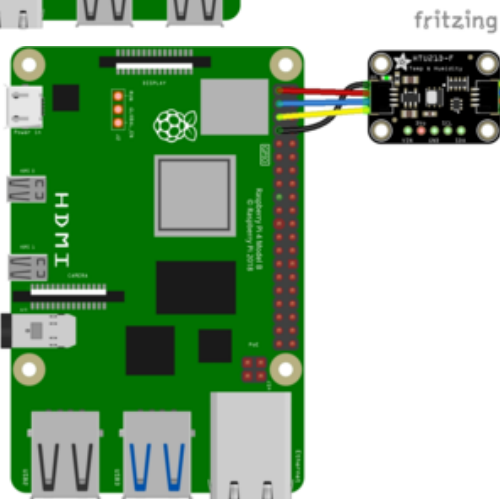

## CircuitPython Installation of HTU21D Library

You'll need to install the [Adafruit CircuitPython HTU21D \(https://adafru.it/CDn\)](https://adafru.it/CDn) library on your CircuitPython board.

First make sure you are running the [latest version of Adafruit CircuitPython \(https://adafru.it/Amd\)](https://adafru.it/Amd) for your board.

Next you'll need to install the necessary libraries to use the hardware--carefully follow the steps to find and install these libraries from [Adafruit's CircuitPython library bundle \(https://adafru.it/uap\)](https://adafru.it/uap). Our CircuitPython starter guide has [a great page on how to install the library bundle \(https://adafru.it/ABU\)](https://adafru.it/ABU).

For non-express boards like the Trinket M0 or Gemma M0, you'll need to manually install the necessary libraries from the bundle:

- adafruit\_htu21d.mpy
- adafruit\_bus\_device

Before continuing make sure your board's lib folder or root filesystem has the adafruit\_htu21d.mpy, and adafruit\_bus\_device files and folders copied over.

Next [connect to the board's serial REPL \(https://adafru.it/Awz\)](https://adafru.it/Awz) so you are at the CircuitPython >>> prompt.

## Python Installation of HTU21D Library

You'll need to install the Adafruit\_Blinka library that provides the CircuitPython support in Python. This may also require enabling I2C on your platform and verifying you are running Python 3. [Since each platform is a little different, and Linux changes often, please visit the CircuitPython on Linux guide to get your computer ready \(https://adafru.it/BSN\)](https://adafru.it/BSN)!

Once that's done, from your command line run the following command:

- `sudo pip3 install adafruit-circuitpython-htu21d`

If your default Python is version 3 you may need to run 'pip' instead. Just make sure you aren't trying to use CircuitPython on Python 2.x, it isn't supported!

## CircuitPython & Python Usage

To demonstrate the usage of the sensor we'll initialize it and read the humidity and temperature values from the board's Python REPL.



Run the following code to import the necessary modules and initialize the I2C connection with the sensor:

```
import time
import board
import busio
from adafruit_htu21d import HTU21D

# Create library object using our Bus I2C port
i2c = busio.I2C(board.SCL, board.SDA)
sensor = HTU21D(i2c)
```

Now you're ready to read values from the sensor using any of these properties:

- `temperature` - the temperature in degrees Celsius.
- `relative_humidity` - the relative humidity in percent.

For example to print temperature:

```
print("\nTemperature: %0.1f C" % sensor.temperature)
```

```
Python 3.5.3 (default, Jan 19 2017, 14:11:04)
[GCC 6.3.0 20170124] on linux
Type "help", "copyright", "credits" or "license" for more information.
>>> import time
>>> import board
>>> import busio
>>> from adafruit_htu21d import HTU21D
>>>
>>> # Create library object using our Bus I2C port
.. i2c = busio.I2C(board.SCL, board.SDA)
>>> sensor = HTU21D(i2c)
>>> print("\nTemperature: %0.1f C" % sensor.temperature)

Temperature: 17.0 C
>>> □
```

That's all there is to using the HTU21D-F sensor with CircuitPython!

## Full Example Code

```
# SPDX-FileCopyrightText: 2021 ladyada for Adafruit Industries
# SPDX-License-Identifier: MIT

import time
import board
from adafruit_htu21d import HTU21D

# Create sensor object, communicating over the board's default I2C bus
i2c = board.I2C() # uses board.SCL and board.SDA
sensor = HTU21D(i2c)
```

```

while True:
    print("\nTemperature: %0.1f C" % sensor.temperature)
    print("Humidity: %0.1f %" % sensor.relative_humidity)
    time.sleep(2)

```

# Python Docs

[Python Docs \(https://adafru.it/CDF\)](https://adafru.it/CDF)

# Downloads

# Files & Datasheets

- [Datasheet for the HTU21D-F \(https://adafru.it/dKR\)](https://adafru.it/dKR) (the -F part is for the PTFE Filter, which is the white insert on top of the sensor)
- [Fritzing object in Adafruit Fritzing library \(https://adafru.it/aP3\)](https://adafru.it/aP3)
- [EagleCAD PCB files in GitHub \(https://adafru.it/r5F\)](https://adafru.it/r5F)
- [K&R Smith calibration notes \(https://adafru.it/BfU\)](https://adafru.it/BfU)

# Schematic and Fab Print for STEMMA QT Version

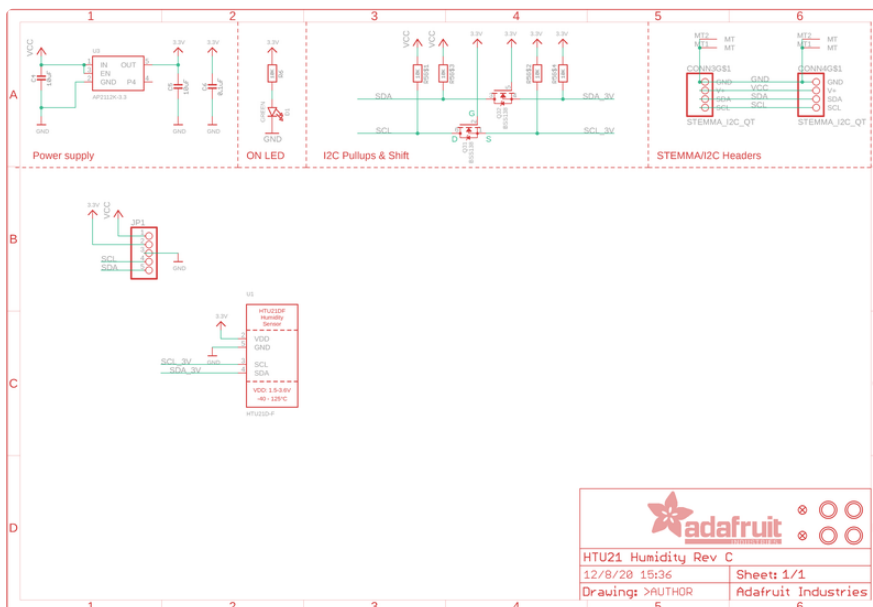

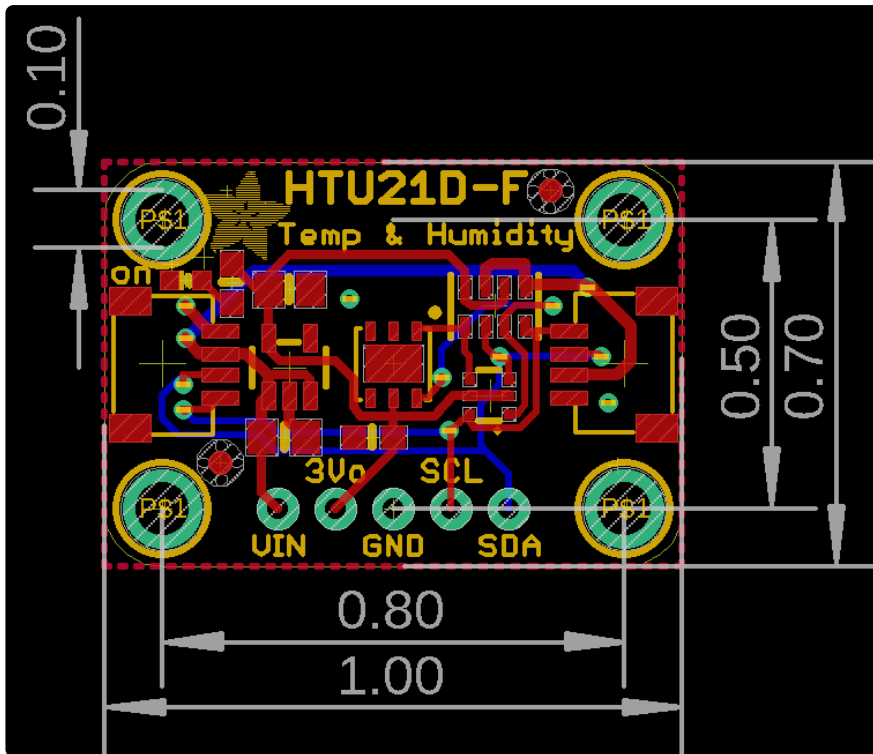

## Schematic and Fab Print for Original Version

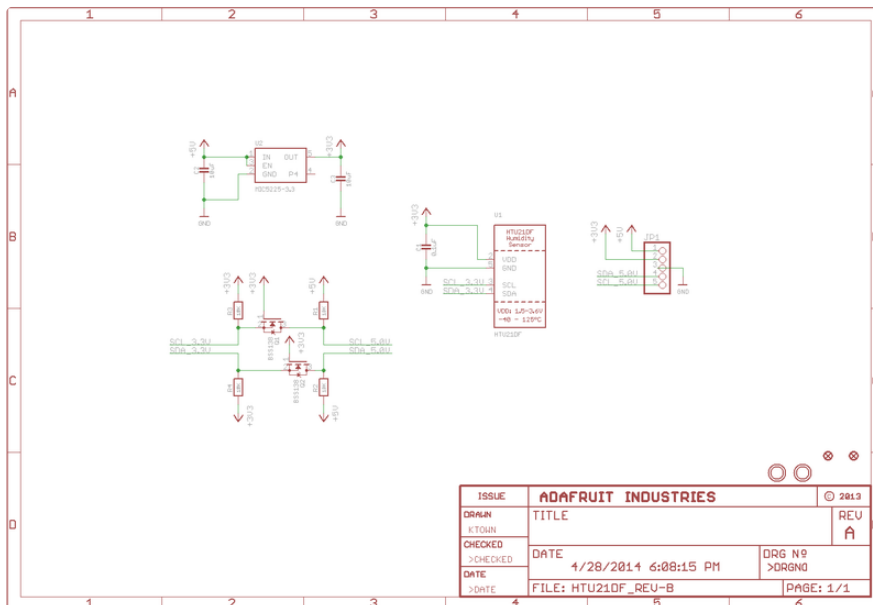

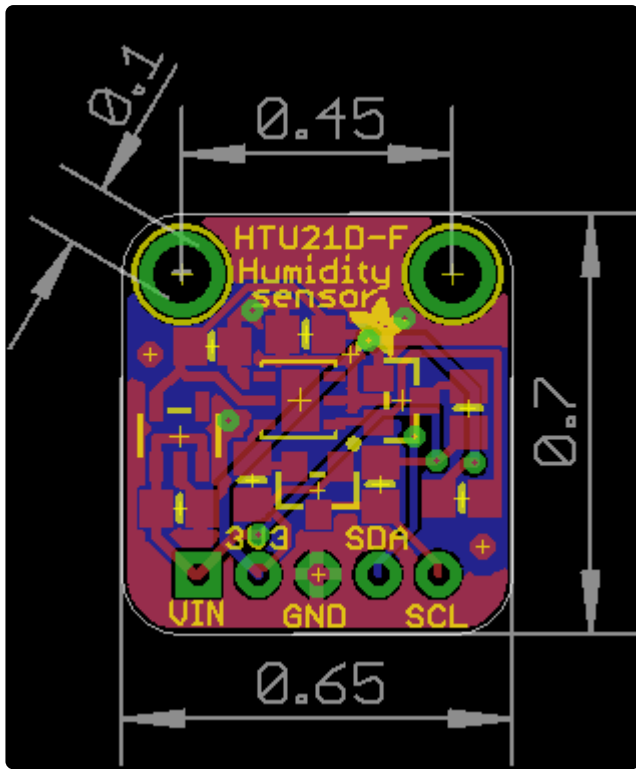

# Mouser Electronics

Authorized Distributor

Click to View Pricing, Inventory, Delivery & Lifecycle Information:

[Adafruit:](#)

[1899](#)