

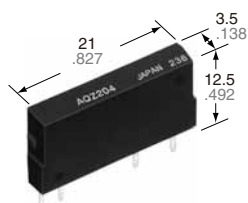

Slim type with high capacity up to 4A DC load type also available

**PhotoMOS®
Power 1 Form A
(AQZ100, 200)**



(Height includes standoff)

mm inch

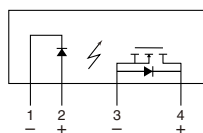

DC type

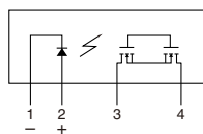

AC/DC type

RoHS compliant

FEATURES

- 1. Slim SIL4-pin package**
(W) 3.5 × (D) 21.0 × (H) 12.5 mm
(W) .138 × (D) .827 × (H) .492 inch
The compact size of the 4-pin SIL package allows high density mounting.
- 2. Extremely low on-resistance**
- 3. Control low-level signal**
Power PhotoMOS feature extremely low closed-circuit offset voltage to enable control of low-level analog signals without distortion.
- 4. Low-level off state leakage current of max. 10 μA**
- 5. High I/O isolation voltage of 2,500 V**
- 6. Eliminates the need for a counter electromotive protection diode in the drive circuit on the input side**
- 7. Eliminates the need for a power supply to drive the power MOSFET**
- 8. No restriction on mounting direction**
- 9. Low thermoelectromotive force**
- 10. Neither noise nor arc at contact**
- 11. Sockets are also available**
(PA1a-PS, PA1a-PS-H)
- 12. Can be installed on the RT-3 relay terminal (Power PhotoMOS type)**

TYPICAL APPLICATIONS

- Traffic signals
- Measuring instruments
- Industrial machines

TYPES

1. DC type

	Output rating*		Package	Part No.	Packing quantity	
	Load voltage	Load current			Inner carton	Outer carton
DC only	60 V	4.0 A	SIL4-pin	AQZ102	25 pcs.	500 pcs.
	100 V	2.6 A		AQZ105		
	200 V	1.3 A		AQZ107		
	400 V	0.7 A		AQZ104		

* Load voltage and current of DC type: DC

2. AC/DC type

	Output rating*		Package	Part No.	Packing quantity	
	Load voltage	Load current			Inner carton	Outer carton
AC/DC dual use	60 V	3.0 A	SIL4-pin	AQZ202	25 pcs.	500 pcs.
	100 V	2.0 A		AQZ205		
	200 V	1.0 A		AQZ207		
	400 V	0.5 A		AQZ204		

* Load voltage and current of AC/DC type: Peak AC/DC.

RATING

1. DC type

1) Absolute maximum ratings (Ambient temperature: 25°C 77°F)

Item		Symbol	AQZ102	AQZ105	AQZ107	AQZ104	Remarks
Input	LED forward current	I_F	50 mA				
	LED reverse voltage	V_R	5 V				
	Peak forward current	I_{FP}	1 A				f = 100 Hz, Duty factor = 0.1%
	Power dissipation	P_{in}	75 mW				
Output	Load voltage (DC)	V_L	60 V	100 V	200 V	400 V	
	Continuous load current (DC)	I_L	4.0 A	2.6 A	1.3 A	0.7 A	
	Peak load current	I_{peak}	9.0 A	6.0 A	3.0 A	1.5 A	100 ms (1 shot), $V_L = DC$
	Power dissipation	P_{out}	1.35 W				
Total power dissipation		P_T	1.35 W				
I/O isolation voltage		V_{iso}	2,500 V AC				
Temperature limits	Operating	T_{opr}	-40°C to +85°C -40°F to +185°F				Non-condensing at low temperatures
	Storage	T_{stg}	-40°C to +100°C -40°F to +212°F				

2) Electrical characteristics (Ambient temperature: 25°C 77°F)

Item			Symbol	AQZ102	AQZ105	AQZ107	AQZ104	Condition
Input	LED operate current	Typical	I_{Fon}	1.0 mA				$I_L = 100 mA$ $V_L = 10 V$
		Maximum		3.0 mA				
	LED turn off current	Minimum	I_{Foff}	0.4 mA				$I_L = 100 mA$ $V_L = 10 V$
		Typical		0.9 mA				
LED dropout voltage	Typical	V_F	1.25 V (1.16 V at $I_F = 10 mA$)				$I_F = 50 mA$	
	Maximum		1.5 V					
Output	On resistance	Typical	R_{on}	0.05 Ω	0.081 Ω	0.34 Ω	1.06 Ω	$I_F = 10 mA$ $I_L = Max.$ Within 1 s on time
		Maximum		0.09 Ω	0.17 Ω	0.55 Ω	1.6 Ω	
	Off state leakage current	Maximum	I_{Leak}	10 μA				$I_F = 0 mA$ $V_L = Max.$
Transfer characteristics	Turn on time*	Typical	T_{on}	1.66 ms	1.89 ms	0.83 ms	1.01 ms	$I_F = 10 mA$ $I_L = 100 mA$ $V_L = 10 V$
		Maximum		5.0 ms				
		Typical		3.79 ms	4.50 ms	1.75 ms	2.34 ms	$I_F = 5 mA$ $I_L = 100 mA$ $V_L = 10 V$
		Maximum		10.0 ms				
	Turn off time*	Typical	T_{off}	0.15 ms	0.19 ms	0.08 ms	0.08 ms	$I_F = 5 mA$ or 10 mA $I_L = 100 mA$ $V_L = 10 V$
		Maximum		3.0 ms				
	I/O capacitance	Typical	C_{iso}	0.8 pF				f = 1 MHz $V_B = 0 V$
		Maximum		1.5 pF				
Initial I/O isolation resistance	Minimum	R_{iso}	1,000 MΩ				500 V DC	
Maximum operating speed	Maximum	—	0.5 times/s				$I_F = 10 mA$ Duty factor = 50% $I_L \times V_L = 200 (VA)$	
Vibration resistance	Minimum	—	10 to 55 Hz at double amplitude of 3 mm				2 hours for 3 axes	
Shock resistance	Minimum	—	4,900 m/s ² {500 G} 1 ms				3 times for 3 axes	

2. AC/DC type

1) Absolute maximum ratings (Ambient temperature: 25°C 77°F)

Item		Symbol	AQZ202	AQZ205	AQZ207	AQZ204	Remarks
Input	LED forward current	I_F	50 mA				
	LED reverse voltage	V_R	5 V				
	Peak forward current	I_{FP}	1 A				$f = 100 \text{ Hz}$, Duty factor = 0.1%
	Power dissipation	P_{in}	75 mW				
Output	Load voltage (Peak AC)	V_L	60 V	100 V	200 V	400 V	
	Continuous load current	I_L	3.0 A	2.0 A	1.0 A	0.5 A	Peak AC, DC
	Peak load current	I_{peak}	9.0 A	6.0 A	3.0 A	1.5 A	100 ms (1 shot), $V_L = \text{DC}$
	Power dissipation	P_{out}	1.6 W				
Total power dissipation		P_T	1.6 W				
I/O isolation voltage		V_{iso}	2,500 V AC				
Temperature limits	Operating	T_{opr}	-40°C to +85°C -40°F to +185°F				Non-condensing at low temperatures
	Storage	T_{stg}	-40°C to +100°C -40°F to +212°F				

2) Electrical characteristics (Ambient temperature: 25°C 77°F)

Item			Symbol	AQZ202	AQZ205	AQZ207	AQZ204	Condition
Input	LED operate current	Typical	I_{Fon}	1.0 mA				$I_L = 100 \text{ mA}$ $V_L = 10 \text{ V}$
		Maximum		3.0 mA				
	LED turn off current	Minimum	I_{Foff}	0.4 mA				$I_L = 100 \text{ mA}$ $V_L = 10 \text{ V}$
		Typical		0.9 mA				
	LED dropout voltage	Typical	V_F	1.25 V (1.16 V at $I_F = 10 \text{ mA}$)				$I_F = 50 \text{ mA}$
		Maximum		1.5 V				
Output	On resistance	Typical	R_{on}	0.11 Ω	0.23 Ω	0.7 Ω	2.1 Ω	$I_F = 10 \text{ mA}$ $I_L = \text{Max.}$ Within 1 s on time
		Maximum		0.18 Ω	0.34 Ω	1.1 Ω	3.2 Ω	
	Off state leakage current	Maximum	I_{Leak}	10 μA				$I_F = 0 \text{ mA}$ $V_L = \text{Max.}$
	Transfer characteristics	Turn on time*	Typical	T_{on}	2.46 ms	2.40 ms	1.12 ms	1.65 ms
Maximum			5.0 ms					
Typical			5.64 ms		5.65 ms	2.57 ms	3.88 ms	
Maximum			10.0 ms					
Turn off time*		Typical	T_{off}	0.22 ms	0.21 ms	0.10 ms	0.08 ms	$I_F = 5 \text{ mA or } 10 \text{ mA}$ $I_L = 100 \text{ mA}$ $V_L = 10 \text{ V}$
		Maximum		3.0 ms				
I/O capacitance		Typical	C_{iso}	0.8 pF				$f = 1 \text{ MHz}$ $V_B = 0 \text{ V}$
		Maximum		1.5 pF				
Initial I/O isolation resistance	Minimum	R_{iso}	1,000 M Ω				500 V DC	
Maximum operating speed	Maximum	—	0.5 cps				$I_F = 10 \text{ mA}$ Duty factor = 50% $I_L = \text{Max.}$, $V_L = \text{Max.}$	
Vibration resistance	Minimum	—	10 to 55 Hz at double amplitude of 3 mm				2 hours for 3 axes	
Shock resistance	Minimum	—	4,900 m/s ² {500 G} 1 ms				3 times for 3 axes	

*Turn on/off time

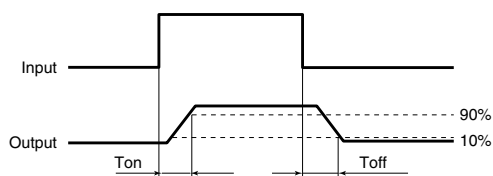

RECOMMENDED OPERATING CONDITIONS

Please obey the following conditions to ensure proper device operation and resetting.

Item	Symbol	Recommended value	Unit
Input LED current	I_F	5 to 10	mA

■ These products are not designed for automotive use.

If you are considering to use these products for automotive applications, please contact your local Panasonic Corporation technical representative.

REFERENCE DATA

1.-(1) Load current vs. ambient temperature characteristics (DC type)

Allowable ambient temperature: -40°C to +85°C
-40°F to +185°F

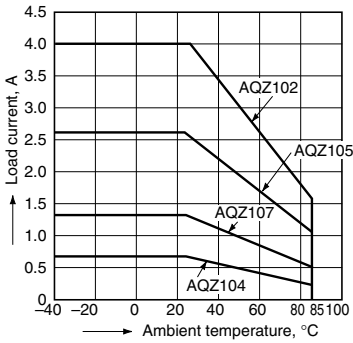

1.-(2) Load current vs. ambient temperature characteristics (AC/DC type)

Allowable ambient temperature: -40°C to +85°C
-40°F to +185°F

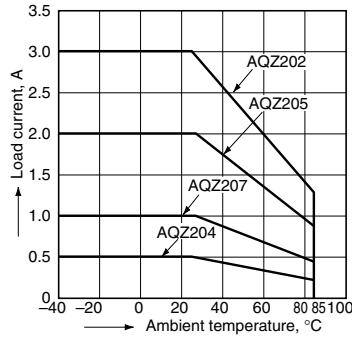

2. Load current vs. ambient temperature characteristics in adjacent mounting

I_L : Load current;
 I_L (max.): Maximum continuous load current

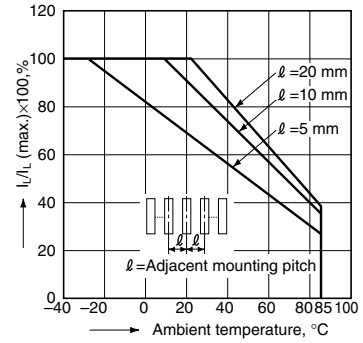

3.-(1) On resistance vs. ambient temperature characteristics (DC type)

LED current: 10 mA;
Continuous load current: 1.6 A (DC) (AQZ102),
1.04 A (DC) (AQZ105)

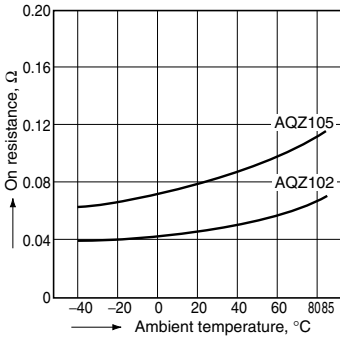

3.-(2) On resistance vs. ambient temperature characteristics (DC type)

LED current: 10 mA;
Continuous load current: 0.52 A (DC) (AQZ107),
0.28 A (DC) (AQZ104)

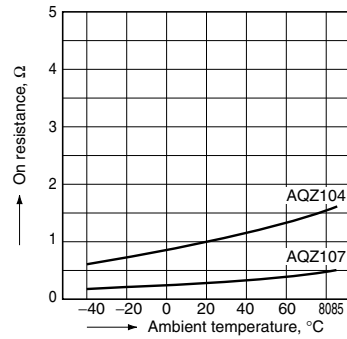

3.-(3) On resistance vs. ambient temperature characteristics (AC/DC type)

LED current: 10 mA;
Continuous load current: 1.2 A (DC) (AQZ202),
0.8 A (DC) (AQZ205)

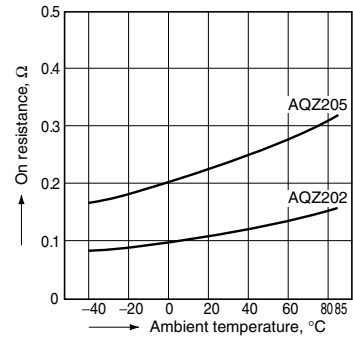

3.-(4) On resistance vs. ambient temperature characteristics (AC/DC type)

LED current: 10 mA;
Continuous load current: 0.4 A (DC) (AQZ207),
0.2 A (DC) (AQZ204)

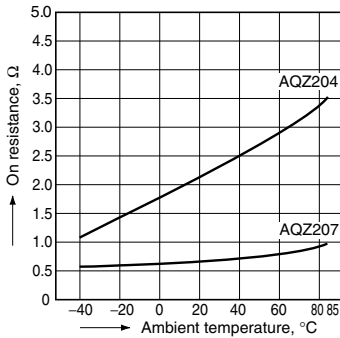

4.-(1) Turn on time vs. ambient temperature characteristics (DC type)

LED current: 10 mA;
Load voltage: 10 V (DC);
Continuous load current: 100 mA (DC)

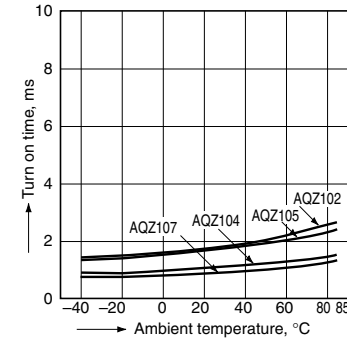

4.-(2) Turn on time vs. ambient temperature characteristics (AC/DC type)

LED current: 10 mA;
Load voltage: 10 V (DC);
Continuous load current: 100 mA (DC)

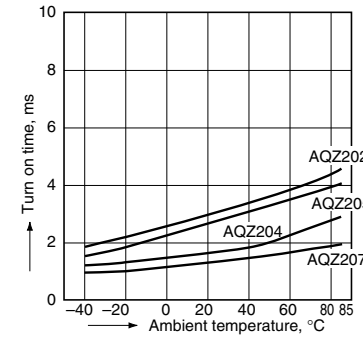

5.-(1) Turn off time vs. ambient temperature characteristics (DC type)

LED current: 10 mA;
Load voltage: 10 V (DC);
Continuous load current: 100 mA (DC)

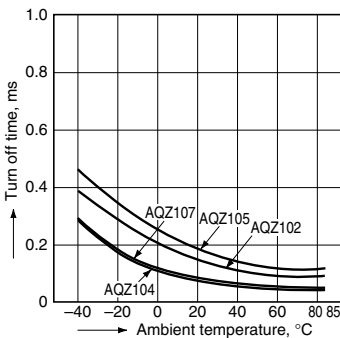

5.-(2) Turn off time vs. ambient temperature characteristics (AC/DC type)

LED current: 10 mA;
Load voltage: 10 V (DC);
Continuous load current: 100 mA (DC)

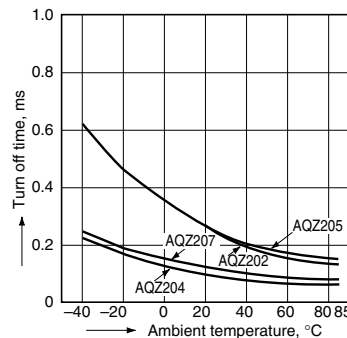

6.-(1) LED operate vs. ambient temperature characteristics (DC type)

Load voltage: 10 V (DC);
Continuous load current: 100 mA (DC)

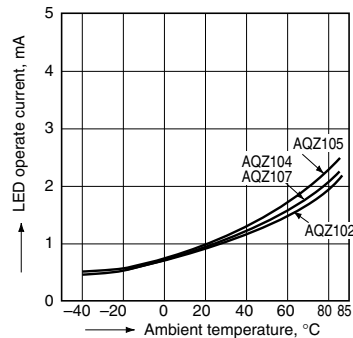

6.-(2) LED operate vs. ambient temperature characteristics (AC/DC type)

Load voltage: 10 V (DC);
Continuous load current: 100 mA (DC)

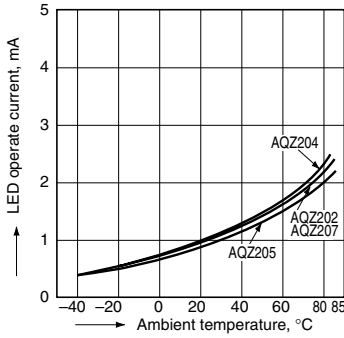

7.-(1) LED turn off current vs. ambient temperature characteristics (DC type)

Load voltage: 10 V (DC);
Continuous load current: 100 mA (DC)

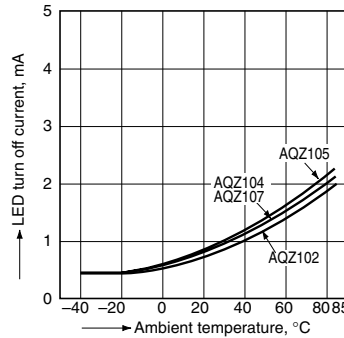

7.-(2) LED turn off current vs. ambient temperature characteristics (AC/DC type)

Load voltage: 10 V (DC);
Continuous load current: 100 mA (DC)

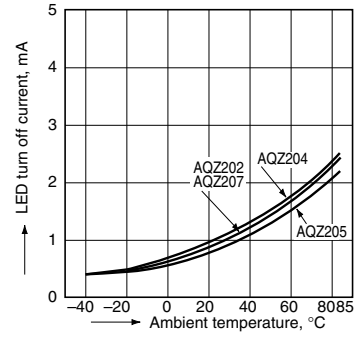

8. LED dropout voltage vs. ambient temperature characteristics

Sample: all types; LED current: 5 to 50 mA

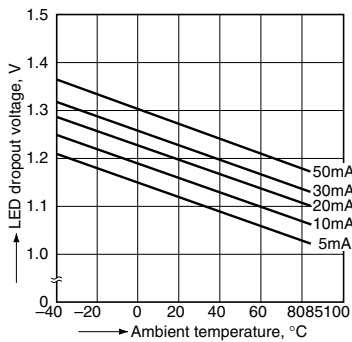

9.-(1) Current vs. voltage characteristics of output at MOS portion (DC type)

Ambient temperature: 25°C 77°F

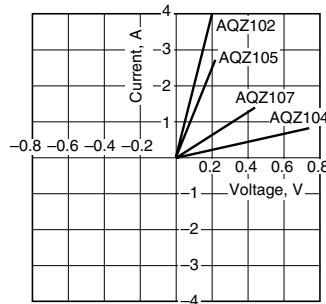

9.-(2) Current vs. voltage characteristics of output at MOS portion (AC/DC type)

Ambient temperature: 25°C 77°F

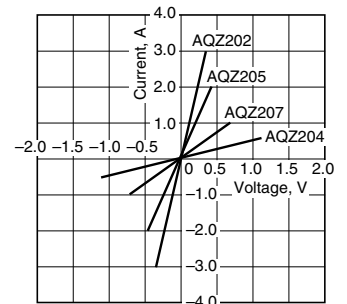

10.-(1) Off state leakage current vs. load voltage characteristics

Ambient temperature: 25°C 77°F

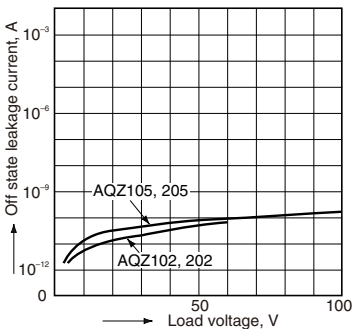

10.-(2) Off state leakage current vs. load voltage characteristics

Ambient temperature: 25°C 77°F

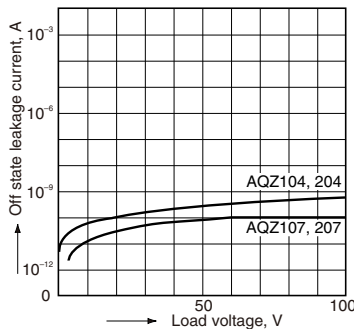

11.-(1) Turn on time vs. LED forward current characteristics (DC type)

Load voltage: 10 V (DC);
Continuous load current: 100 mA (DC);
Ambient temperature: 25°C 77°F

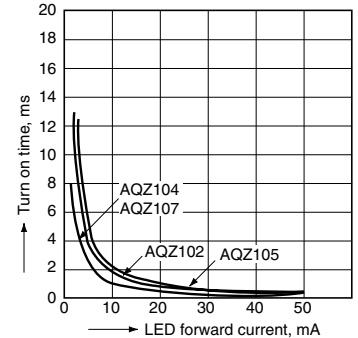

11.-(2) Turn on time vs. LED forward current characteristics (AC/DC type)

Load voltage: 10 V (DC);
Continuous load current: 100 mA (DC);
Ambient temperature: 25°C 77°F

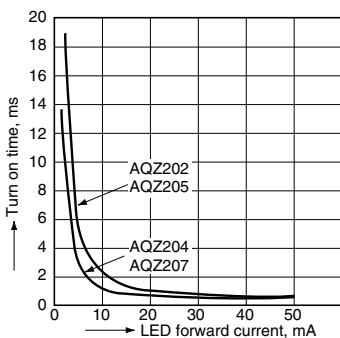

12.-(1) Turn off time vs. LED forward current characteristics (DC type)

Measured portion: between terminals 4 and 6;
Load voltage: 10 V (DC);
Continuous load current: 100 mA (DC);
Ambient temperature: 25°C 77°F

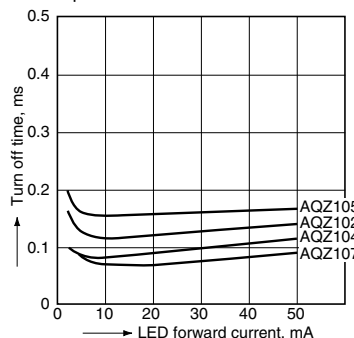

12.-(2) Turn off time vs. LED forward current characteristics (AC/DC type)

Load voltage: 10 V (DC);
Continuous load current: 100 mA (DC);
Ambient temperature: 25°C 77°F

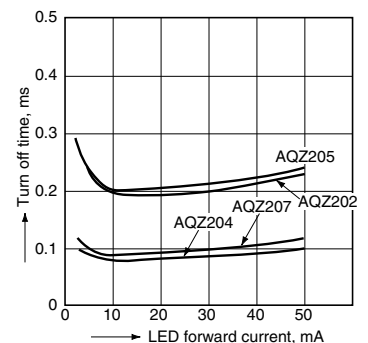

13.-(1) Turn on time vs. load voltage characteristics (DC type)

LED current: 10 mA;
Continuous load current: 100 mA;
Ambient temperature: 25°C 77°F

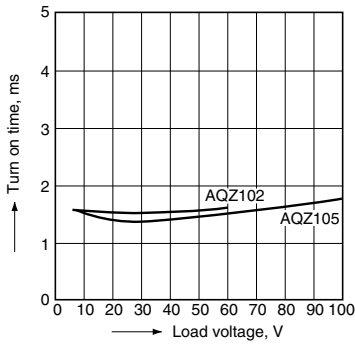

13.-(2) Turn on time vs. load voltage characteristics (DC type)

LED current: 10 mA;
Continuous load current: 100 mA;
Ambient temperature: 25°C 77°F

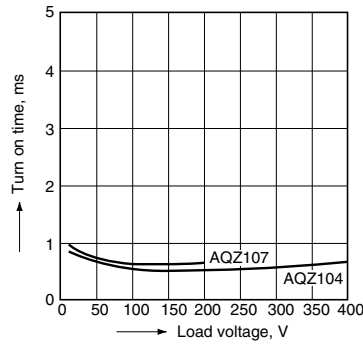

13.-(3) Turn on time vs. load voltage characteristics (AC/DC type)

LED current: 10 mA;
Continuous load current: 100 mA;
Ambient temperature: 25°C 77°F

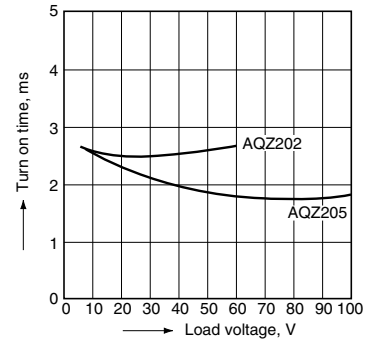

13.-(4) Turn on time vs. load voltage characteristics (AC/DC type)

LED current: 10 mA;
Continuous load current: 100 mA;
Ambient temperature: 25°C 77°F

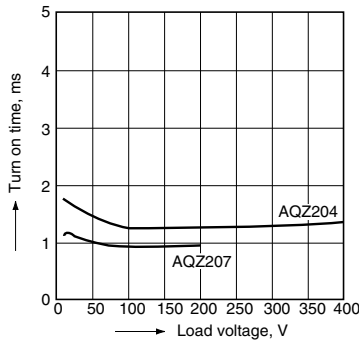

14.-(1) Turn on time vs. load current characteristics (DC type)

LED current: 10 mA;
Load voltage: 10 V (DC);
Ambient temperature: 25°C 77°F

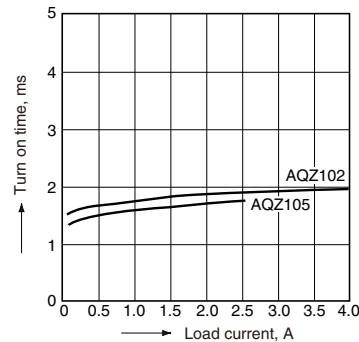

14.-(2) Turn on time vs. load current characteristics (DC type)

LED current: 10 mA;
Load voltage: 10 V (DC);
Ambient temperature: 25°C 77°F

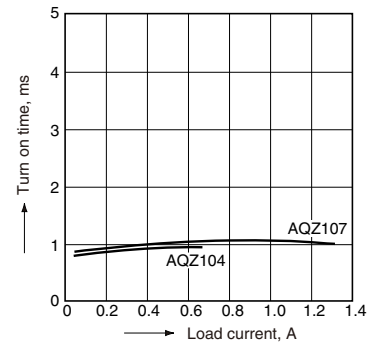

14.-(3) Turn on time vs. load current characteristics (AC/DC type)

LED current: 10 mA;
Load voltage: 10 V (DC);
Ambient temperature: 25°C 77°F

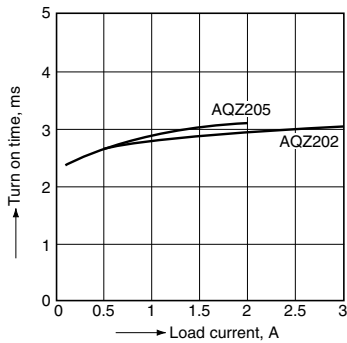

14.-(4) Turn on time vs. load current characteristics (AC/DC type)

LED current: 10 mA;
Load voltage: 10 V (DC);
Ambient temperature: 25°C 77°F

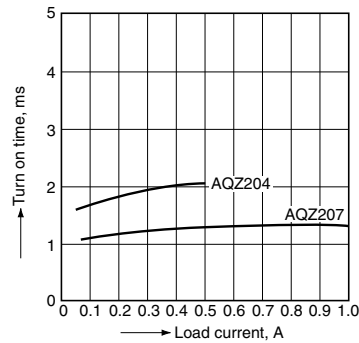

15.-(1) Turn off time vs. load voltage characteristics (DC type)

LED current: 10 mA;
Continuous load current: 100 mA;
Ambient temperature: 25°C 77°F

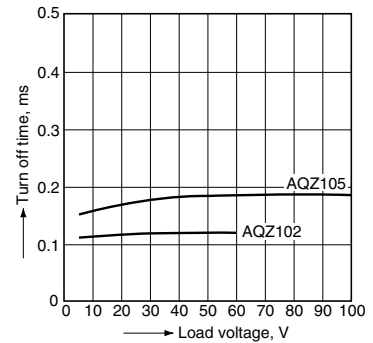

15.-(2) Turn off time vs. load voltage characteristics (DC type)

LED current: 10 mA;
Continuous load current: 100 mA;
Ambient temperature: 25°C 77°F

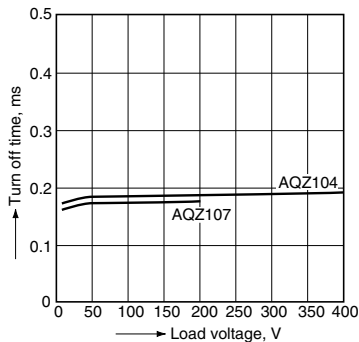

15.-(3) Turn off time vs. load voltage characteristics (AC/DC type)

LED current: 10 mA;
Continuous load current: 100 mA;
Ambient temperature: 25°C 77°F

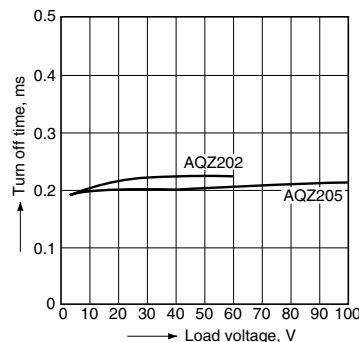

15.-(4) Turn off time vs. load voltage characteristics (AC/DC type)

LED current: 10 mA;
Continuous load current: 100 mA;
Ambient temperature: 25°C 77°F

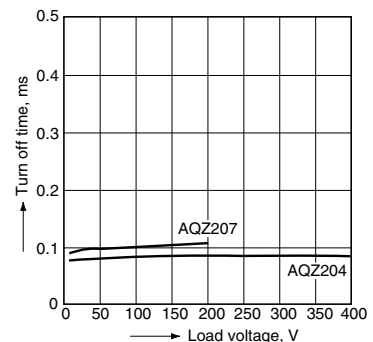

16.-(1) Turn off time vs. load current characteristics (DC type)

LED current: 10 mA;
Load voltage: 10 V (DC);
Ambient temperature: 25°C 77°F

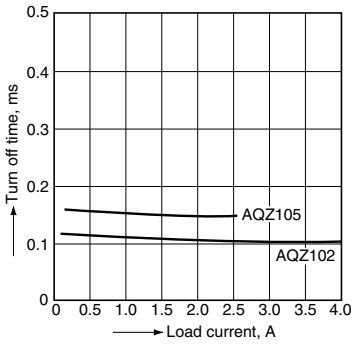

16.-(2) Turn off time vs. load current characteristics (DC type)

LED current: 10 mA;
Load voltage: 10 V (DC);
Ambient temperature: 25°C 77°F

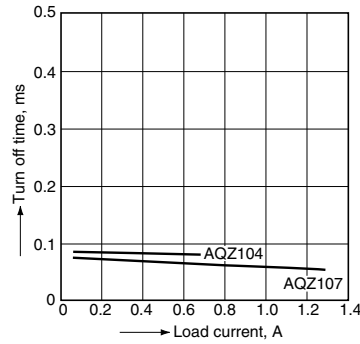

16.-(3) Turn off time vs. load current characteristics (AC/DC type)

LED current: 10 mA;
Load voltage: 10 V (DC);
Ambient temperature: 25°C 77°F

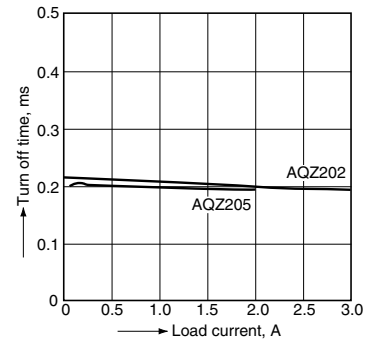

16.-(4) Turn off time vs. load current characteristics (AC/DC type)

LED current: 10 mA;
Load voltage: 10 V (DC);
Ambient temperature: 25°C 77°F

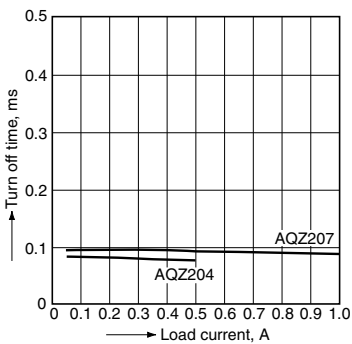

17. Maximum operating frequency vs. load voltage/current characteristics

Sample: All types;
LED current: 10 mA;
Ambient temperature: 25°C 77°F

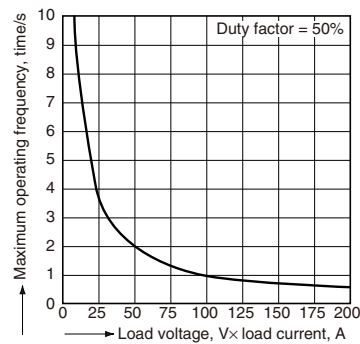

18.-(1) Output capacitance vs. applied voltage characteristics (DC type)

Frequency: 1 MHz;
Ambient temperature: 25°C 77°F

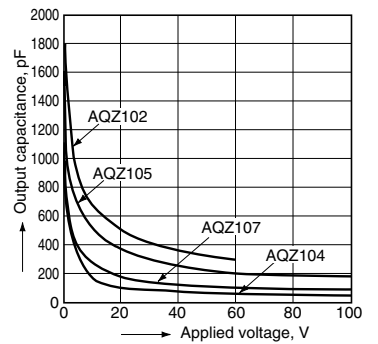

18.-(2) Output capacitance vs. applied voltage characteristics (AC/DC type)

Frequency: 1 MHz;
Ambient temperature: 25°C 77°F

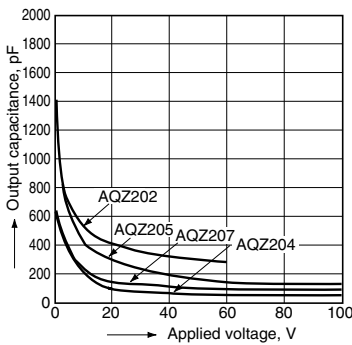

ACCESSORY (mm inch)

Socket

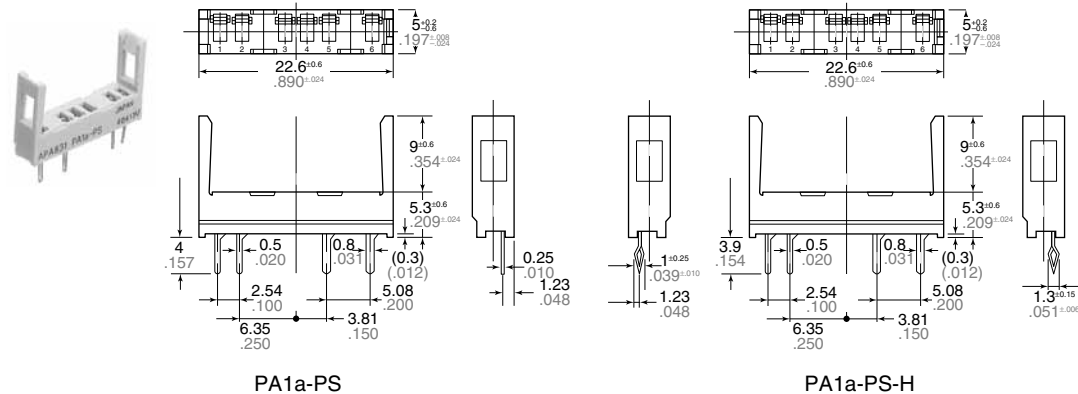

PC board pattern (BOTTOM VIEW) Standard type

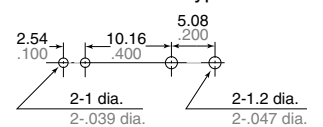

Self clinching type

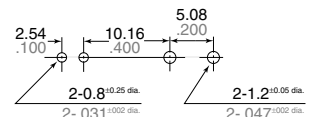

Tolerance: ±0.1 ±0.04