

KEMET Part Number: SC-05-30J
(UALSC0530J0000)

KEMET, SC-J, AC Line Filters, Common Mode, 3000 μ H

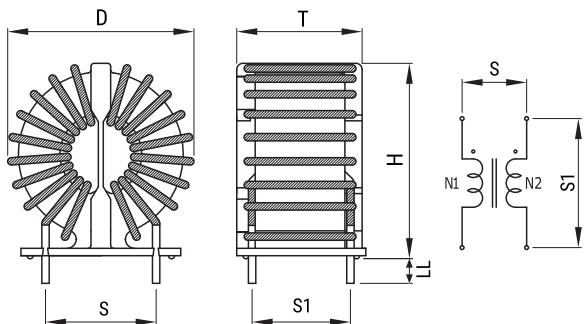

Dimensions	
D	34mm MAX
T	23mm MAX
H	33mm MAX
LL	5mm +/-2mm
S	18mm NOM

Packaging Specifications	
Packaging:	Tray
Packaging Quantity:	200
Weight:	30 g

General Information	
Series:	SC-J
Style:	Through-Hole
RoHS:	Yes
Notes:	Lead Spacing (S/S1) Are For Reference Only.
Miscellaneous:	Temperature Rise Maximum: 55 K

Specifications	
Voltage AC:	250 VAC
Inductance:	3 mH (100 kHz)
Current:	5 A
Temperature Range:	-25/+120°C
DC Resistance:	70 mOhms