

SCM Series

Series-Connected Super Capacitor Modules

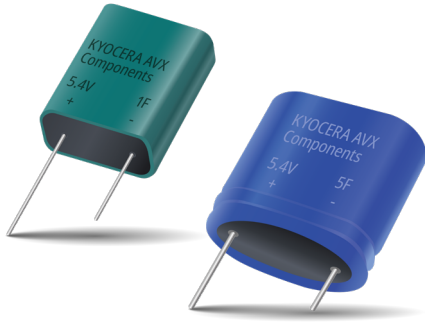

This new series of electrochemical, double-layer, series-connected SuperCapacitor modules offers excellent pulse power handling characteristics based on the combination of very high capacitance and very low ESR. Used by themselves or in conjunction with primary or secondary batteries, they provide extended back up time, longer battery life, and provide instantaneous power pulses as needed. Offers great solutions to hold up, energy harvesting, pulse power applications, and battery replacement.

FEATURES

- High Pulse Power Capability
- Low ESR
- Low Leakage Current
- Plastic, Moisture Resistant Version

APPLICATIONS

- Camera Flash Systems
- Energy Harvesting
- GSM/GPRS Pulse Applications
- UPS/Industrial
- Wireless Alarms
- Remote Metering
- Scanners
- Toys and Games

HOW TO ORDER

SCM	R	14	C	474	P	R	B	A	0
Series SuperCap Module	Diameter Q = 6.3mm R = 8mm / 9.5mm** S = 10mm T = 12.5mm U = 16mm	Case Length Two digits represent case length in mm	Voltage Code C = 5.0V D = 5.4V F = 5.5V G = 7.5V H = 6.0V J = 8.1V L = 9.0V	Capacitance Code 1st two digits represent significant figures 3rd digit represents multiplier (number of zeros to follow)	Tolerance P = +100%/-0% S = +30%/-10%	Package/Lead Format R = Shrink Wrap/Radial S = Plastic/Radial	Package B = Bulk T = Tray*	Balancing A = Unbalanced B = Passive Balanced	Lead Orientation 0 = Straight Leads 1 = Bent Leads*
								*Inquire about availability **Plastic/Radial version	

QUALITY INSPECTION

Parts are tested for life cycle, high temperature load life, temperature characteristics, vibration resistance, and humidity characteristics. See pages 2-5 for more information.

TERMINATION

These SuperCapacitors are compatible with hand soldering and wave soldering processes, so long as appropriate precautions are followed. See 12 for more information.



For RoHS compliant products, please select correct termination style.

5.4V/5.0V Series-Connected SuperCapacitors Modules

Part Number	Diameter (mm)	Length (mm)	Rated Capacitance (F)	Capacitance Tolerance	Rated Voltage (V)	Rated Temperature (°C)	DCL Max @ 72 Hrs (µA)	ESR Max @ 1000 Hz (mΩ)	ESR Max @ DC (mΩ)	Peak Current (A)	Power Density (W/kg)	Max Energy (Wh)	Energy Density (Wh/kg)
Shrink Wrap / Radial Lead													
SCMQ14C474PRBA0	6.3	14	0.47	+100%/-0%	5.0/4.2*	65/85*	3	400	1000	0.80	2143	0.0016	1.17
SCMQ14C474PRTA0	6.3	14	0.47	+100%/-0%	5.0/4.2*	65/85*	3	400	1000	0.80	2143	0.0016	1.17
SCMQ14D474PRBB0	6.3	14	0.47	+100%/-0%	5.4/4.6*	65/85*	6	400	1000	0.86	2499	0.0019	1.36
SCMQ14D474PRTB0	6.3	14	0.47	+100%/-0%	5.4/4.6*	65/85*	6	400	1000	0.86	2499	0.0019	1.36
SCMR14C474PRBA0	8	14	0.47	+100%/-0%	5.0/4.2*	65/85*	5	300	1000	0.80	1429	0.0016	0.78
SCMR14D474PRBB0	8	14	0.47	+100%/-0%	5.4/4.6*	65/85*	6	300	1000	0.86	1666	0.0019	0.91
SCMR18C105PRBA0	8	18	1	+100%/-0%	5.0/4.2*	65/85*	8	200	720	1.45	1667	0.0035	1.39
SCMR18D105PRBB0	8	18	1	+100%/-0%	5.4/4.6*	65/85*	10	200	720	1.57	1944	0.0041	1.62
SCMR22C155PRBA0	8	22	1.5	+100%/-0%	5.0/4.2*	65/85*	10	190	580	2.01	1669	0.0052	1.68
SCMR22D155PRBB0	8	22	1.5	+100%/-0%	5.4/4.6*	65/85*	15	190	580	2.17	1946	0.0061	1.96
SCMS22C255PRBA0	10	22	2.5	+100%/-0%	5.0/4.2*	65/85*	20	140	360	3.29	1852	0.0087	1.93
SCMS22D255PRBB0	10	22	2.5	+100%/-0%	5.4/4.6*	65/85*	25	140	360	3.55	2113	0.0101	2.20
SCMT22C505PRBA0	12.5	22	5	+100%/-0%	5.0/4.2*	65/85*	25	100	150	7.14	2740	0.0174	2.38
SCMT22D505PRBB0	12.5	22	5	+100%/-0%	5.4/4.6*	65/85*	30	100	150	7.71	3069	0.0203	2.66
SCMT32C755SRBA0	12.5	32	7.5	+30%/-10%	5.0/4.2*	65/85*	65	70	160	8.52	1953	0.0260	2.71
SCMT32D755SRBB0	12.5	32	7.5	+30%/-10%	5.4/4.6*	65/85*	70	70	160	9.20	2209	0.0304	3.07

*with appropriate voltage derating operating temperature can be extended to 85°C

OPERATING TEMPERATURE RANGE

-40°C to +65°C @ 5.4V Balanced, 5.0V Unbalanced
 -40°C to +85°C @ 4.6V Balanced, 4.2V Unbalanced

QUALIFICATION TEST SUMMARY

Test	Test Method	Parameter	Limits
Life Cycle	Capacitors are cycled between rated voltage and half-rated voltage under constant current at +25°C for 500,000 cycles	Capacitance ESR Appearance	≤30% of spec value ≤200% of spec value No remarkable defects
High Temperature Load Life	Temperature: +65°C Voltage: Rated Voltage Test Duration: 1,000 hours	Capacitance ESR Appearance	≤30% of spec value ≤200% of spec value No remarkable defects
Storage Temperature Characteristics	Storage Duration: 2 years No Load Temperature: +35°C	Capacitance ESR Appearance	≤30% of spec value ≤200% of spec value No remarkable defects
Vibration Resistance	Amplitude: 1.5mm Frequency: 10 ~ 55Hz Direction: X, Y, Z for 2 hours each	Capacitance ESR Appearance	≤30% of spec value ≤200% of spec value No remarkable defects
Humidity	Voltage: Rated Voltage RH: 90% Temperature: +60°C Test Duration: 1,000 hours	Capacitance ESR Appearance	≤30% of spec value ≤200% of spec value No remarkable defects

Part Number	Diameter (mm)	Length (mm)	Rated Capacitance (F)	Capacitance Tolerance	Rated Voltage (V)	Rated Temperature (°C)	DCL Max @ 72 Hrs (μA)	ESR Max @ 1000 Hz (mΩ)	ESR Max @ DC (mΩ)	Peak Current (A)	Power Density (W/kg)	Max Energy (Wh)	Energy Density (Wh/kg)
Shrink Wrap / Radial Lead													
SCMQ14F474PRBA0	6.3	14	0.47	+100%/-0%	5.5/4.6*	65/85*	6	500	3000	0.54	864	0.0020	1.41
SCMQ14H474PRBB0	6.3	14	0.47	+100%/-0%	6.0/5.0*	65/85*	7	500	3000	0.59	1029	0.0024	1.68
SCMR14F474PRBA0	8	14	0.47	+100%/-0%	5.5/4.6*	65/85*	6	380	1720	0.71	1005	0.0020	0.94
SCMR14H474PRBB0	8	14	0.47	+100%/-0%	6.0/5.0*	65/85*	7	380	1720	0.78	1196	0.0024	1.12
SCMR18F105PRBA0	8	18	1	+100%/-0%	5.5/4.6*	65/85*	9	250	720	1.60	2017	0.0042	1.68
SCMR18H105PRBB0	8	18	1	+100%/-0%	6.0/5.0*	65/85*	11	250	720	1.74	2400	0.0050	2.00
SCMR22F155PRBA0	8	22	1.5	+100%/-0%	5.5/4.6*	65/85*	12	200	560	2.24	2091	0.0063	2.03
SCMR22H155PRBB0	8	22	1.5	+100%/-0%	6.0/5.0*	65/85*	18	200	560	2.45	2488	0.0075	2.42
SCMS22F255PRBA0	10	22	2.5	+100%/-0%	5.5/4.6*	65/85*	24	180	340	3.72	2373	0.0105	2.33
SCMS22H255PRBB0	10	22	2.5	+100%/-0%	6.0/5.0*	65/85*	30	180	340	4.05	2762	0.0125	2.72
SCMS32F505PRBA0	10	32	5	+100%/-0%	5.5/4.6*	65/85*	30	120	150	7.86	3580	0.0210	3.11
SCMS32H505PRBB0	10	32	5	+100%/-0%	6.0/5.0*	65/85*	36	120	150	8.57	4235	0.0250	3.68
SCMT22F505PRBA0	12.5	22	5	+100%/-0%	5.5/4.6*	65/85*	30	120	150	7.86	3176	0.0210	2.76
SCMT32F755SRBA0	12.5	32	7.5	+30%/-10%	5.5/4.6*	65/85*	78	90	120	10.86	3151	0.0315	3.28
SCMT32H755SRBB0	12.5	32	7.5	+30%/-10%	6.0/5.0*	65/85*	84	90	120	11.84	3600	0.0375	3.75
SCMU33F156SRBA0	16	33	15	+30%/-10%	5.5/4.6*	65/85*	85	35	50	23.57	4033	0.0630	3.50
SCMU33F156SRBB0	16	33	15	+30%/-10%	5.5/4.6*	65/85*	90	35	50	23.57	3946	0.0630	3.43
Plastic / Radial Lead													
SCMR14F474PSBA0	9.5	16	0.47	+100%/-0%	5.5/4.6*	65/85*	6	380	1720	0.71	541	0.0020	0.51
SCMR14H474PSBB0	9.5	16	0.47	+100%/-0%	6.0/5.0*	65/85*	7	380	1720	0.78	644	0.0024	0.60
SCMR18F105PSBA0	9.5	20	1	+100%/-0%	5.5/4.6*	65/85*	9	250	720	1.60	1096	0.0042	0.91
SCMR18H105PSBB0	9.5	20	1	+100%/-0%	6.0/5.0*	65/85*	11	250	720	1.74	1304	0.0050	1.09
SCMR22F155PSBA0	9.5	24	1.5	+100%/-0%	5.5/4.6*	65/85*	12	200	560	2.24	1179	0.0063	1.15
SCMR22H155PSBB0	9.5	24	1.5	+100%/-0%	6.0/5.0*	65/85*	18	200	560	2.45	1403	0.0075	1.36

OPERATING TEMPERATURE RANGE

-40°C to +65°C @ 6.0V Balanced, 5.5V Unbalanced
 -40°C to +85°C @ 5.0V Balanced, 4.6V Unbalanced

QUALIFICATION TEST SUMMARY

Test	Test Method	Parameter	Limits
Life Cycle	Capacitors are cycled between rated voltage and half-rated voltage under constant current at +25°C for 500,000 cycles	Capacitance ESR Appearance	≤30% of spec value ≤200% of spec value No remarkable defects
High Temperature Load Life	Temperature: +65°C Voltage: Rated Voltage Test Duration: 1,000 hours	Capacitance ESR Appearance	≤30% of spec value ≤200% of spec value No remarkable defects
Storage Temperature Characteristics	Storage Duration: 2 years No Load Temperature: +35°C	Capacitance ESR Appearance	≤30% of spec value ≤200% of spec value No remarkable defects
Vibration Resistance	Amplitude: 1.5mm Frequency: 10 ~ 55Hz Direction: X, Y, Z for 2 hours each	Capacitance ESR Appearance	≤30% of spec value ≤200% of spec value No remarkable defects
Humidity	Voltage: Rated Voltage RH: 90% Temperature: +60°C Test Duration: 1,000 hours	Capacitance ESR Appearance	≤30% of spec value ≤200% of spec value No remarkable defects

7.5V Series-Connected Super Capacitor Modules

Part Number	Diameter (mm)	Length (mm)	Rated Capacitance (F)	Capacitance Tolerance	Rated Voltage (V)	Rated Temperature (°C)	DCL Max @ 72 Hrs (µA)	ESR Max @ 1000 Hz (mΩ)	ESR Max @ DC (mΩ)	Peak Current (A)	Power Density (W/kg)	Max Energy (Wh)	Energy Density (Wh/kg)
Shrink Wrap / Radial Lead													
SCMR14G334SRBA0	8	14	0.33	+30%/-10%	7.5/6.4*	65/85*	6	450	900	0.95	2419	0.0026	0.83
SCMR14G334SRBB0	8	14	0.33	+30%/-10%	7.5/6.4*	65/85*	7	450	900	0.95	2419	0.0026	0.83
SCMR18G604SRBA0	8	18	0.6	+30%/-10%	7.5/6.4*	65/85*	9	225	450	1.77	3947	0.0047	1.23
SCMR18G604SRBB0	8	18	0.6	+30%/-10%	7.5/6.4*	65/85*	11	225	450	1.77	3846	0.0047	1.20
SCMR22G105SRBA0	8	22	1	+30%/-10%	7.5/6.4*	65/85*	10	180	360	2.76	4076	0.0078	1.70
SCMR22G105SRBB0	8	22	1	+30%/-10%	7.5/6.4*	65/85*	15	180	360	2.76	3989	0.0078	1.66

*with appropriate voltage derating operating temperature can be extended to 85°C

OPERATING TEMPERATURE RANGE

-40°C to +65°C @ 7.5V
 -40°C to +85°C @ 6.4V

QUALIFICATION TEST SUMMARY

Test	Test Method	Parameter	Limits
Life Cycle	Capacitors are cycled between rated voltage and half-rated voltage under constant current at +25°C for 500,000 cycles	Capacitance ESR Appearance	≤30% of spec value ≤200% of spec value No remarkable defects
High Temperature Load Life	Temperature: +65°C Voltage: Rated Voltage Test Duration: 1,000 hours	Capacitance ESR Appearance	≤30% of spec value ≤200% of spec value No remarkable defects
Storage Temperature Characteristics	Storage Duration: 2 years No Load Temperature: +35°C	Capacitance ESR Appearance	≤30% of spec value ≤200% of spec value No remarkable defects
Vibration Resistance	Amplitude: 1.5mm Frequency: 10 ~ 55Hz Direction: X, Y, Z for 2 hours each	Capacitance ESR Appearance	≤30% of spec value ≤200% of spec value No remarkable defects
Humidity	Voltage: Rated Voltage RH: 90% Temperature: +60°C Test Duration: 1,000 hours	Capacitance ESR Appearance	≤30% of spec value ≤200% of spec value No remarkable defects

9.0V/8.1V Series-Connected Super Capacitor Modules

Part Number	Diameter (mm)	Length (mm)	Rated Capacitance (F)	Capacitance Tolerance	Rated Voltage (V)	Rated Temperature (°C)	DCL Max @ 72 Hrs (μA)	ESR Max @ 1000 Hz (mΩ)	ESR Max @ DC (mΩ)	Peak Current (A)	Power Density (W/kg)	Max Energy (Wh)	Energy Density (Wh/kg)
Shrink Wrap / Radial Lead													
SCMR14J334SRBA0	8	14	0.33	+30%/-10%	8.1/6.9*	65/85*	6	500	2850	0.69	897	0.0030	0.98
SCMR14J334SRBB0	8	14	0.33	+30%/-10%	8.1/6.9*	65/85*	7	500	2850	0.69	869	0.0030	0.95
SCMR14L334SRBB0	8	14	0.33	+30%/-10%	9.0/7.6*	65/85*	7	500	2850	0.77	1072	0.0037	1.17
SCMR18J604SRBA0	8	18	0.6	+30%/-10%	8.1/6.9*	65/85*	9	400	1080	1.47	1934	0.0055	1.45
SCMR18J604SRBB0	8	18	0.6	+30%/-10%	8.1/6.9*	65/85*	12	400	1080	1.47	1869	0.0055	1.40
SCMR18L604SRBB0	8	18	0.6	+30%/-10%	9.0/7.6*	65/85*	12	400	1080	1.64	2308	0.0068	1.73
SCMR22J105SRBA0	8	22	1	+30%/-10%	8.1/6.9*	65/85*	12	350	840	2.20	1986	0.0091	1.93
SCMR22J105SRBB0	8	22	1	+30%/-10%	8.1/6.9*	65/85*	15	350	840	2.20	1894	0.0091	1.84
SCMR22L105SRBB0	8	22	1	+30%/-10%	9.0/7.6*	65/85*	18	350	840	2.45	2338	0.0113	2.27
Plastic / Radial Lead													
SCMR14J334SSBA0	9.5	16	0.33	+30%/-10%	8.1/6.9*	65/85*	6	500	2850	0.69	498	0.0030	0.54
SCMR14L334SSBB0	9.5	16	0.33	+30%/-10%	9.0/7.6*	65/85*	7	500	2850	0.77	598	0.0037	0.65
SCMR18J604SSBA0	9.5	20	0.6	+30%/-10%	8.1/6.9*	65/85*	9	400	1080	1.47	1063	0.0055	0.80
SCMR18L604SSBB0	9.5	20	0.6	+30%/-10%	9.0/7.6*	65/85*	12	400	1080	1.64	1286	0.0068	0.96
SCMR22J105SSBA0	9.5	24	1	+30%/-10%	8.1/6.9*	65/85*	12	350	840	2.20	1129	0.0091	1.10
SCMR22L105SSBB0	9.5	24	1	+30%/-10%	9.0/7.6*	65/85*	18	350	840	2.45	1361	0.0113	1.32

OPERATING TEMPERATURE RANGE

-40°C to +65°C @ 9.0V Balanced, 8.1V Unbalanced
 -40°C to +85°C @ 7.6V Balanced, 6.9V Unbalanced

QUALIFICATION TEST SUMMARY

Test	Test Method	Parameter	Limits
Life Cycle	Capacitors are cycled between rated voltage and half-rated voltage under constant current at +25°C for 500,000 cycles	Capacitance ESR Appearance	≤30% of spec value ≤200% of spec value No remarkable defects
High Temperature Load Life	Temperature: +65°C Voltage: Rated Voltage Test Duration: 1,000 hours	Capacitance ESR Appearance	≤30% of spec value ≤200% of spec value No remarkable defects
Storage Temperature Characteristics	Storage Duration: 2 years No Load Temperature: +35°C	Capacitance ESR Appearance	≤30% of spec value ≤200% of spec value No remarkable defects
Vibration Resistance	Amplitude: 1.5mm Frequency: 10 ~ 55Hz Direction: X, Y, Z for 2 hours each	Capacitance ESR Appearance	≤30% of spec value ≤200% of spec value No remarkable defects
Humidity	Voltage: Rated Voltage RH: 90% Temperature: +60°C Test Duration: 1,000 hours	Capacitance ESR Appearance	≤30% of spec value ≤200% of spec value No remarkable defects

QUALITY AND RELIABILITY

CAPACITANCE VS. TEMPERATURE

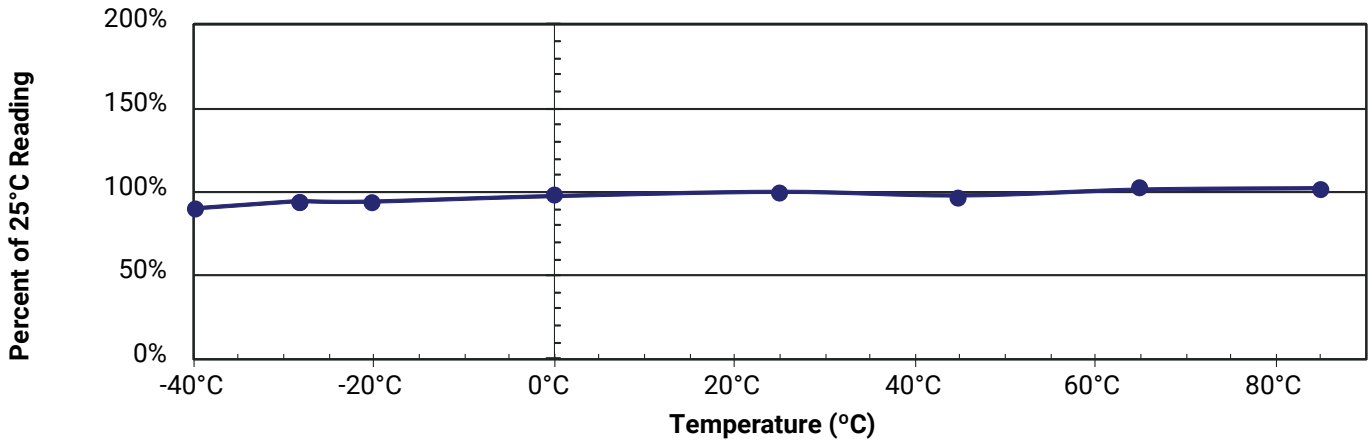

LEAKAGE CURRENT VS. TEMPERATURE

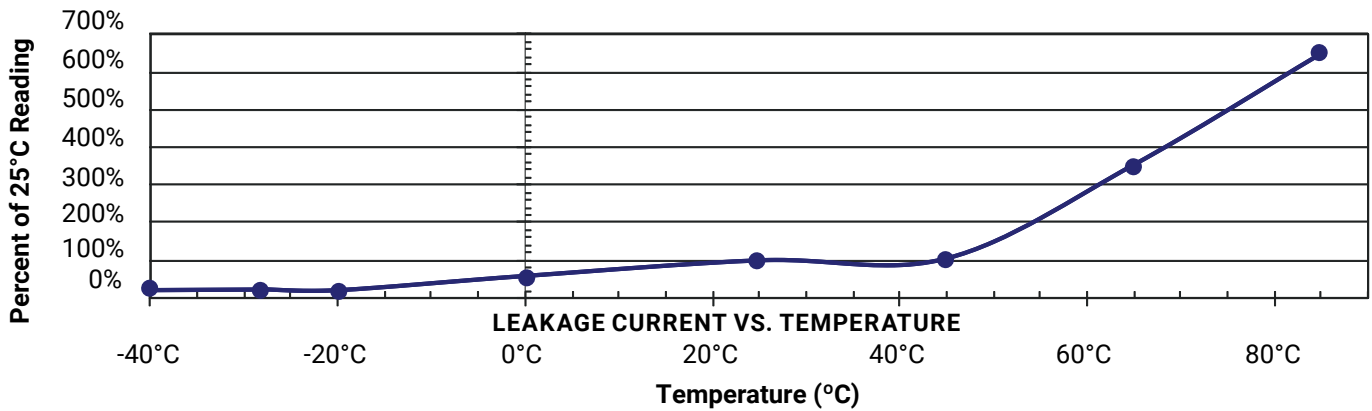

EQUIVALENT SERIES RESISTANCE VS. TEMPERATURE

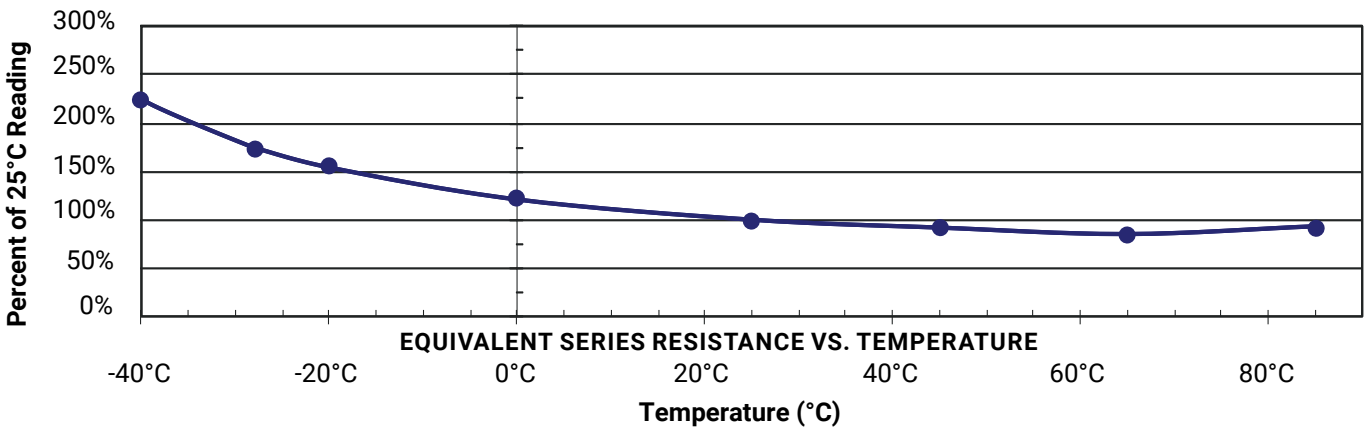

SCM Series

Series-Connected Super Capacitor Modules



MECHANICAL SPECIFICATIONS

5.4V, 6.0V SHRINK WRAP TYPE - STRAIGHT LEADS

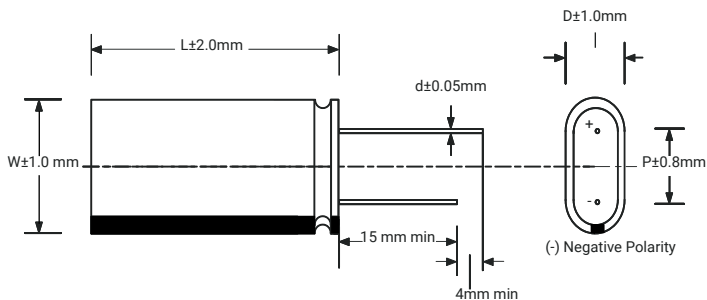

5.4V, 6.0V SHRINK WRAP TYPE - BENT LEADS

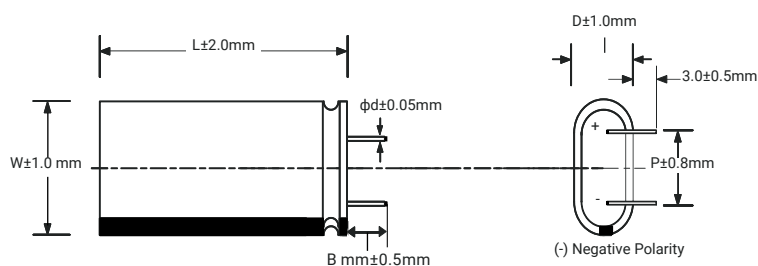

Cap (F)	D (mm)	W (mm)	L (mm)	P (mm)	d (mm)	B (mm)*
0.47	6.3	13.6	14.0	9.0	0.6	2.0
0.47	8.0	16.0	14.0	11.5	0.6	2.0
1	8.0	16.0	18.0	11.5	0.6	2.0
1.5	8.0	16.0	22.0	11.5	0.6	2.0
2.5	10.0	20.0	22.0	15.5	0.6	2.0
5	10.0	20.0	32.0	15.5	0.6	2.0
5	12.5	25.0	22.0	18.0	0.6	2.0
7.5	12.5	25.0	32.0	18.0	0.6	2.0
15	16.0	32.0	33.0	23.7	0.8	2.0

*for version with bent leads

7.5V, 9.0V SHRINK WRAP TYPE - STRAIGHT LEADS

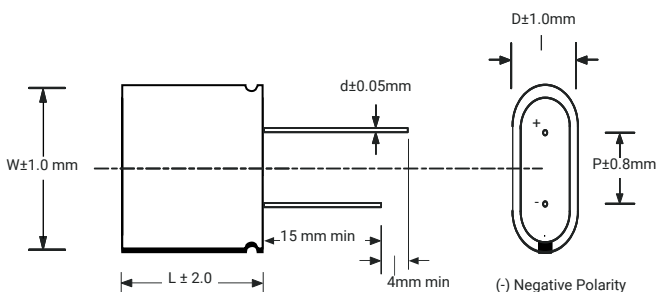

7.5V, 9.0V SHRINK WRAP TYPE - BENT LEADS

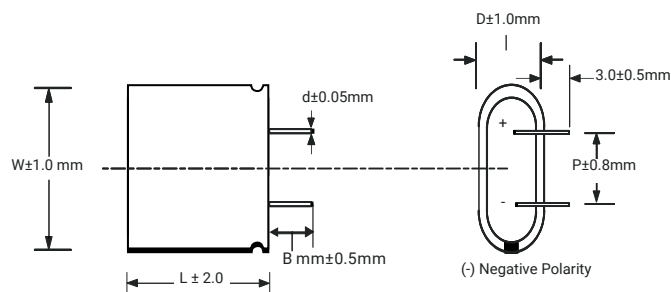

Cap (F)	D (mm)	W (mm)	L (mm)	P (mm)	d (mm)	B (mm)*
0.33	8.0	24.0	14.0	13.5	0.6	2.0
0.6	8.0	24.0	18.0	13.5	0.6	2.0
1	8.0	24.0	22.0	13.5	0.6	2.0

*for version with bent leads

MECHANICAL SPECIFICATIONS

6.0V PLASTIC TYPE - STRAIGHT LEADS

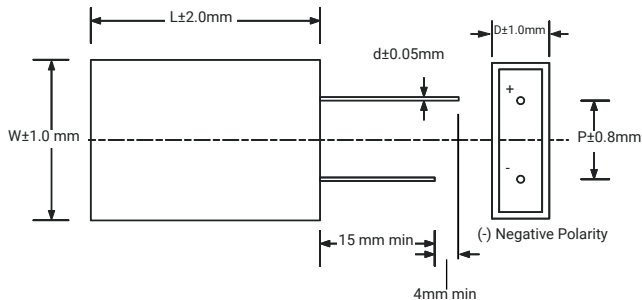

6.0V PLASTIC TYPE - BENT LEADS

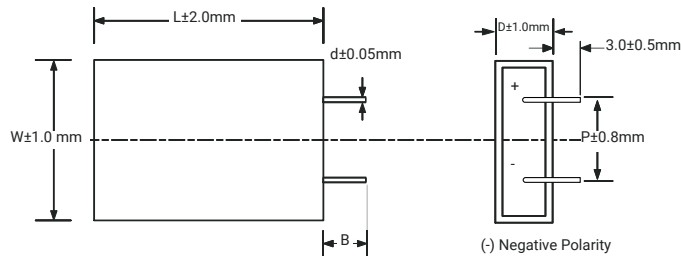

Cap (F)	D (mm)	W (mm)	L (mm)	P (mm)	d (mm)	B (mm)*
0.47	9.5	18.5	16.0	11.5	0.6	2.0
1	9.5	18.5	20.0	11.5	0.6	2.0
1.5	9.5	18.5	24.0	11.5	0.6	2.0

*for version with bent leads

9.0V PLASTIC TYPE - STRAIGHT LEADS

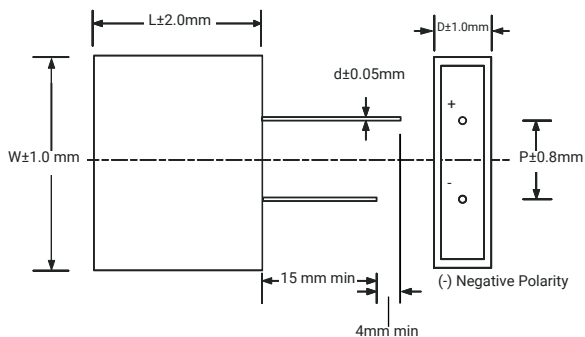

9.0V Plastic Type - Bent Leads

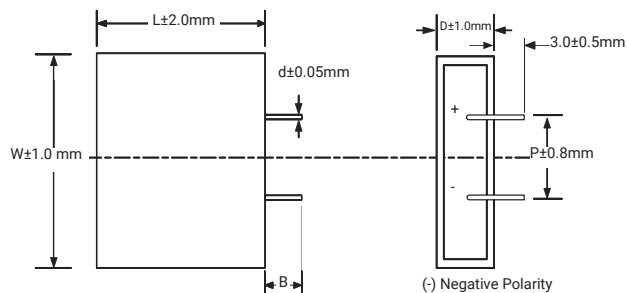

Cap (F)	D (mm)	W (mm)	L (mm)	P (mm)	d (mm)	B (mm)*
0.33	9.5	26.6	16.0	13.5	0.6	2.0
0.6	9.5	26.6	20.0	13.5	0.6	2.0
1	9.5	26.6	24.0	13.5	0.6	2.0

*for version with bent leads

TEST METHODS

IEC CAPACITANCE TEST METHOD

Procedure: Charge module under constant current to rated voltage at room temperature, then hold 10 minutes on charge under constant voltage. After 10 minutes, discharge under constant current (as shown in chart below), recording voltage at V_1 , V_2 , and time intervals at t_1 and t_2 . Use the capacitance formula to determine cap value.

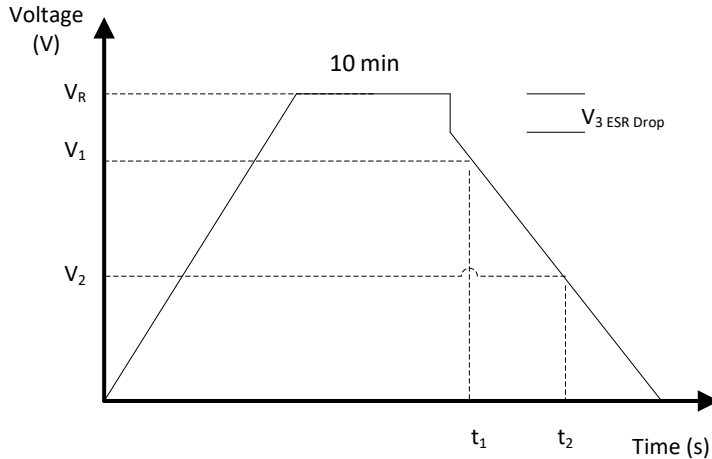

I – Discharge Current, $4 \times C \times V_R$ (mA)

V_R – Rated Voltage (V)

V_1 – Initial Test Voltage, 80% Of V_R (V)

V_2 – Final Test Voltage, 40% Of V_R (V)

t_1 – Initial Test Time (s)

t_2 – Final Test Time (s)

$$C = \frac{I \times (t_2 - t_1)}{V_1 - V_2}$$

DC ESR MEASUREMENT

A six-step ESR_{DC} test method is illustrated to the right and carried out as follows:

- Rest 10 Seconds
- Charge under constant current (I_1) to rated voltage (V_R)
- Rest 5 seconds
- Rest 10 seconds, record V_3 and t_4
- Discharge under constant current (I_2) to half rated voltage, Record I_2 , V_4 , And t_5
- Rest 2 seconds, record V_5 And t_6

Repeat steps 1-6 recording I , V , And t accordingly, finally discharging to below 0.1V under constant current (I_2).

Formulas to calculate:

• Two cycle discharge capacitances: $C_{dch1} = I_2 \times \frac{(t_5 - t_4)}{V_3 - V_4}$; $C_{dch2} = I_2 \times \frac{(t_{11} - t_{10})}{(V_9 - V_{10})}$

• Discharge capacitance: $C_{dch} = \frac{(C_{dch1} + C_{dch2})}{2}$

• Two cycle discharge DC ESR: $ESR_{dch1} = \frac{(V_5 - V_4)}{I_2}$; $ESR_{dch2} = \frac{(V_{11} - V_{10})}{I_2}$

• Discharge DC ESR: $ESR_{dch} = \frac{(ESR_{dch1} + ESR_{dch2})}{2}$

Note: $I_1 = I_2 = 75mA/F$, the rated capacitance in the chart means discharge capacitance, and DC ESR (ESR_{DC}) means discharge DC resistance.

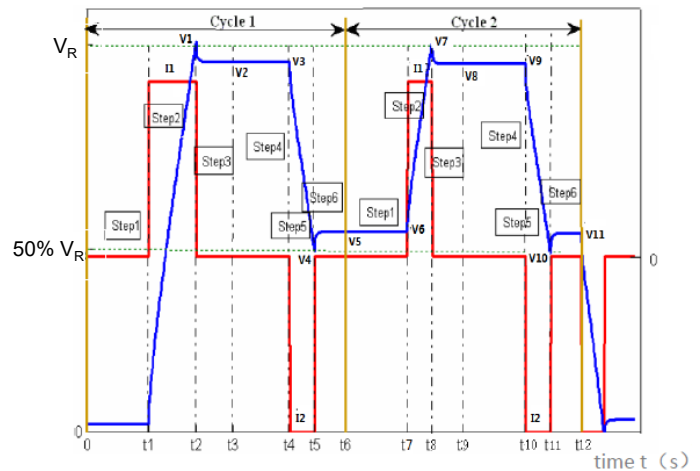

SCM Series

Series-Connected Super Capacitor Modules

TEST METHODS (continued)

MAXIMUM CONTINUOUS CURRENT

- This is the maximum current when temperature rise of the supercapacitor during its operation is less than 15°C

MAXIMUM PEAK CURRENT

- This is the maximum current during 1 second time interval (dt)

WATT DENSITY

- Watt Density = $(0.12 \cdot V^2 / R_{DC}) / \text{mass}$

ENERGY DENSITY

- Energy Density = $(\frac{1}{2} CV^2) / (3600 \cdot \text{mass})$

POLARITY AND REVERSE VOLTAGE

For product consistency and optimum performance, it is recommended that the capacitor be connected with polarity indicated. Reversing polarity could result in permanent damage to the circuit including much higher leakage current for a short duration of time and the life time of the supercapacitors will be reduced.

LIFE TIME AND TEMPERATURE PERFORMANCE

The life of a supercapacitor is impacted by a combination of operating voltage and the operating temperature according to the following Time to Failure equation:

$$t \propto V^n \times e^{\left(\frac{-Q}{kT}\right)}$$

where V is the operating voltage, Q is the activation energy in electron volts (eV), k is the Boltzmann constant in eV, and T is the operating temperature in Kelvin (K). Typical values for the voltage exponent, n, is between 2.5-3.5, and Q is between 1.0-1.2 eV in the normal operating temperature range of -40° to 65°C.

The industry standard for supercapacitor end of life is when the equivalent series resistance, ESR, increases to 200% of the specified value and the capacitance drops by 30% from specified value. Typically a supercapacitor shows an initial “jump” in the ESR value and then levels off. If the supercapacitors are exposed to excessive temperatures the ESR will show a continuous degradation (increase). In the extreme case, if the temperature or voltage are substantially higher than the rated specifications, this could result in the part venting and the product showing a faster degradation of capacitance and ESR, which may be many times the specified value.

SCM Series

Series-Connected Super Capacitor Modules



Expected Lifetime at Various Voltages
SCM Series

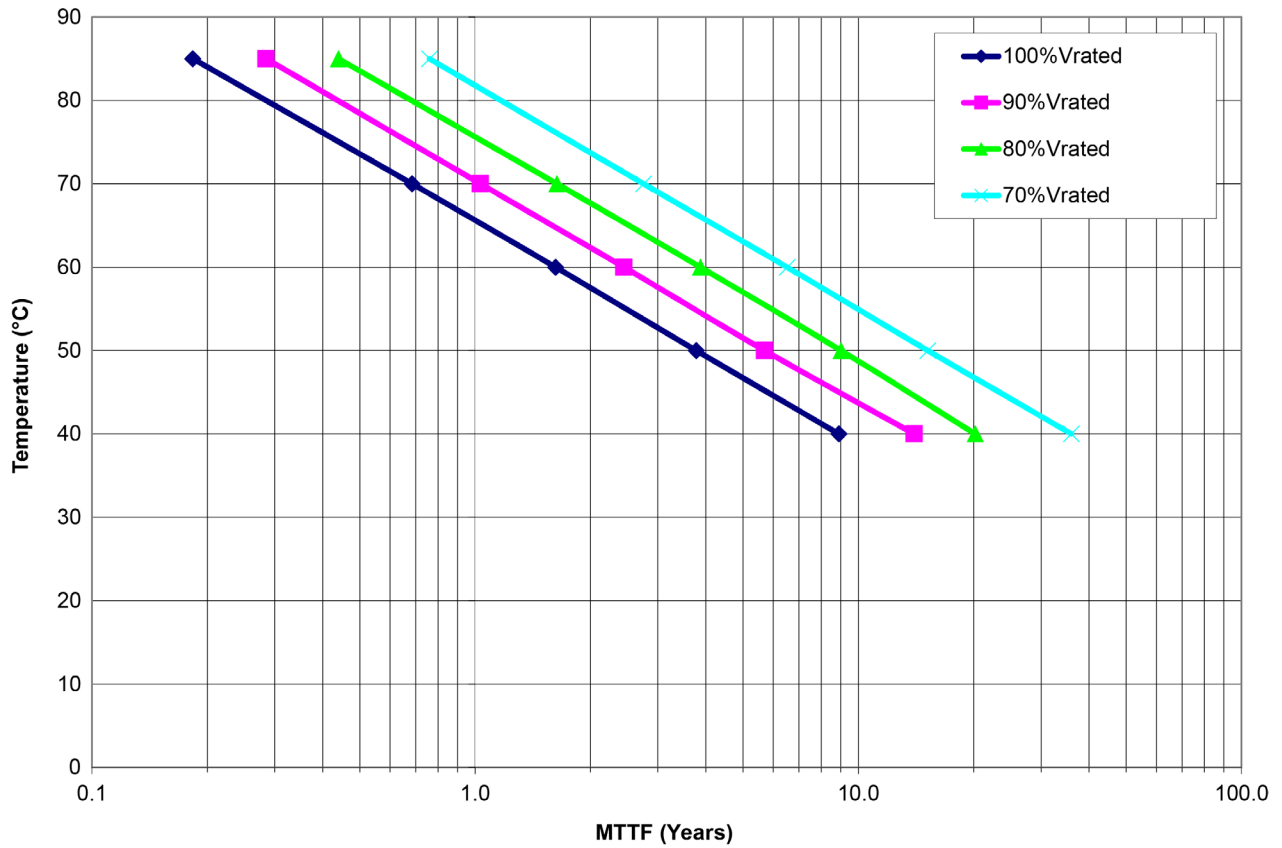

Series-Connected Super Capacitor Modules

SOLDERING RECOMMENDATIONS

When soldering SuperCapacitors to a PCB, the temperature & time that the body of the SuperCapacitor sees during soldering can have a negative effect on performance. We advise following these guidelines:

- Do not immerse the SuperCapacitors in solder. Only the leads should come in contact with the solder.
- Ensure that the body of the SuperCapacitor is never in contact with the molten solder, the PCB or other components during soldering.
- Excessive temperatures or excessive temperature cycling during soldering may cause the safety vent to burst or the case to shrink or crack, potentially damaging the PCB or other components, and significantly reduce the life of the capacitor.

PRECAUTION: For all products with shrink wrap sleeves, washing in any type of cleaning agent is prohibited. During all soldering processes, it's recommended to protect the shrink wrap from any kind of liquid (including but not limited to: water, strong acid, strong alkali, strong oxidizing solutions, and strong solvents) to avoid the risk of damage, cracking, and fading of the outer shrink wrap.

HAND SOLDERING

Keep some distance between the SuperCapacitor body and the tip of the soldering iron; contact between SuperCapacitor body and soldering iron will cause extensive damage to the SuperCapacitor. It is recommended that the soldering iron temperature should be less than 350°C, and contact time should be limited to no more than 4 seconds. Too much exposure to terminal heat during soldering can cause heat to transfer to the body of the SuperCapacitor, potentially damaging the SuperCapacitor.

WAVE SOLDERING

Only use wave soldering on Radial type SuperCapacitors. The PCB should be preheated only from the bottom and for less than 60 seconds, with temperature at, or below, 100°C on the top side of the board for PCBs equal to or greater than 0.8 mm thick.

Solder Temperature (°C)	Suggested Solder Time (s)	Maximum Solder Time (s)
220	7	9
240	7	9
250	5	7
260	3	5

SAFETY RECOMMENDATIONS

WARNINGS

- To avoid short circuit, after usage or test, SuperCapacitor voltage needs to discharge to $\leq 0.1V$
- Do not apply over-voltage, reverse charge, burn or heat higher than 150°C, explosion-proof valve may break open
- Do not press, damage or disassemble the SuperCapacitor, housing could heat to high temperature causing burns
- If you observe overheating or burning smell from the capacitor disconnect power immediately, and do not touch

EMERGENCY APPLICATIONS

If housing is leaking:

- Skin contact: use soap and water thoroughly to wash the area of the skin
- Eye contact: flush with flowing water or saline, and immediately seek medical treatment
- Ingestion: immediately wash with water and seek medical treatment

TRANSPORTATION

Not subjected to US DOT or IATA regulations UN3499, <10Wh, Non-Hazardous Goods International shipping description – “Electronic Products – Capacitor”

REGULATORY

- UL 810A
- RoHS Compliant
- REACH Compliant
- Halogen free according to IEC 61249-2-21: 2003 and IPC/JEDEC-J-STD-709

STORAGE

Capacitors may be stored within the temperature range of -40°C to +70°C with humidity < 60%. Lower storage temperature is preferred as it extends the shelf life of the capacitor. Product over one year and within two years of the date code, we recommend recharging the product at the beginning of use for at least 24 hours.

Optimum storage conditions are as follows:

- 25°C and RH \leq 60% without voltage applied
- Not in direct sunlight
- Not in direct contact with water, salt oil or other chemicals
- Not in direct contact with corrosive materials, acids, alkalis, or toxic gases
- Not in dusty environments
- Not in environments with shock and vibration conditions

Licensed by CAP-XX

Mouser Electronics

Authorized Distributor

Click to View Pricing, Inventory, Delivery & Lifecycle Information:

KYOCERA AVX:

[SCMR22C155MSBA0](#) [SCMR14C474MRBA0](#) [SCMS22C255MRBA0](#) [SCMR14C474MSBA0](#) [SCMT32C755MRBA0](#)
[SCMR22C155MRBA0](#) [SCMR18C105MRBA0](#) [SCMR18C105MSBA0](#) [SCMT22C505MRBA0](#) [SCMQ14C474MRBA0](#)
[SCMR14L334MRBB0](#) [SCMR18L604MRBB0](#) [SCMR14G334MRBA0](#) [SCMQ14F474MRBA0](#) [SCMQ14H474SRBB0](#)
[SCMT32F755MRBA0](#) [SCMR18F105MRBA0](#) [SCMS32H505MRBB0](#) [SCMS22H255MRBB0](#) [SCMR18G604MRBA0](#)
[SCMR14H474MRBB0](#) [SCMR18H105MRBB0](#) [SCMR22F155MRBA0](#) [SCMR22G105MRBA0](#) [SCMR22H155MRBB0](#)
[SCMS22F255MRBA0](#) [SCMT22F505MRBA0](#) [SCMS32F505MRBA0](#) [SCMR22L105MRBB0](#) [SCMR14F474MRBA0](#)
[SCMR18D105MRBB0](#) [SCMR22D155MRBB0](#) [SCMR14D474MRBB0](#) [SCMT22D505MRBB0](#) [SCMT32D755MRBB0](#)
[SCMQ14D474MRBB0](#) [SCMR18D105MSBB0](#) [SCMR14D474MSBB0](#) [SCMR22D155MSBB0](#) [SCMS22D255MRBB0](#)
[SCMR22F155MSBA0](#) [SCMR18F105MSBA0](#) [SCMR14F474MSBA0](#) [SCMR18H105MSBB0](#) [SCMR22H155MSBB0](#)
[SCMR14H474MSBB0](#) [SCMR14J334MSBA0](#) [SCMR18J604MSBA0](#) [SCMR22L105MSBB0](#) [SCMR18L604MSBB0](#)
[SCMR14J334MRBB0](#) [SCMR22J105MRBB0](#) [SCMR22J105MRBA0](#) [SCMR18J604MRBB0](#) [SCMR14J334MRBA0](#)
[SCMR18J604MRBA0](#) [SCMR22J105MSBA0](#) [SCMR14L334MSBB0](#) [SCMS22C255PRBA0](#) [SCMQ14C474PRBA0](#)
[SCMR18D105PRBB0](#) [SCMR18J604SRBB0](#) [SCMR18J604SRBA0](#) [SCMR22G105SRBA0](#) [SCMR14L334SRBB0](#)
[SCMR18C105PRBA0](#) [SCMR18L604SSBB0](#) [SCMS32H505PRBB0](#) [SCMR14L334SSBB0](#) [SCMS32F505PRBA0](#)
[SCMR14H474PSBB0](#) [SCMR18J604SSBA0](#) [SCMR22L105SRBB0](#) [SCMT22F505PRBA0](#) [SCMQ14D474PRBB0](#)
[SCMQ14D474PRTB0](#) [SCMR14H474PRBB0](#) [SCMR18F105PRBA0](#) [SCMQ14C474PRBA0](#) [SCMR14C474PRBA0](#)
[SCMR14J334SRBB0](#) [SCMR14D474PRBB0](#) [SCMR22J105SRBB0](#) [SCMT32D755SRBB0](#) [SCMR14J334SRBA0](#)
[SCMR18L604SRBB0](#) [SCMR22J105SSBA0](#) [SCMT22D505PRBB0](#) [SCMS22F255PRBA0](#) [SCMS22H255PRBB0](#)
[SCMR14F474PSBA0](#) [SCMR18G604SRBA0](#) [SCMR18H105PSBB0](#) [SCMT22C505PRBA0](#) [SCMQ14F474PRBA0](#)
[SCMQ14H474PRBB0](#) [SCMR14J334SSBA0](#) [SCMR22C155PRBA0](#) [SCMR22D155PRBB0](#) [SCMR22J105SRBA0](#)