

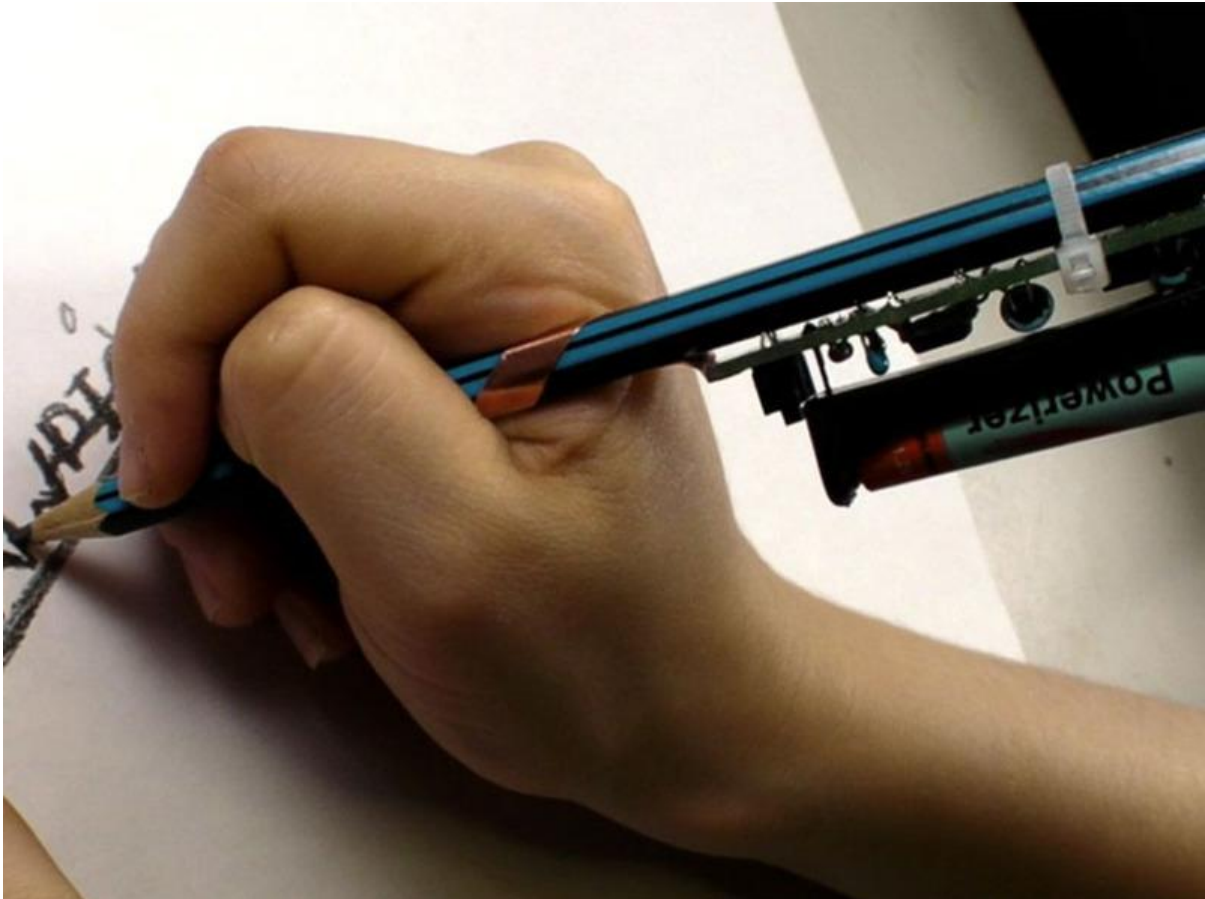

Drawdio

Created by lady ada



<https://learn.adafruit.com/drawdiod>

Last updated on 2021-11-15 05:57:43 PM EST

Table of Contents

Overview	3
• Sketching with Hardware	3
• Drawdio: A pencil that lets you draw with music!	3
• Video!	3
• Credits	3
Design	4
• How does it work?	4
• Power supply	4
• The Oscillator	4
• Amplifier	5
Make it!	6
• Three step plan for success	6
Preparation	6
• Tools	6
Parts list	9
• Bill of Materials for v1.1	9
• Bill of Materials for v1.0	17
Solder it!	25
• Instructions for v1.1	25
• Lets go!	26
Use it!	50
• Ideas for experimentation	50
• How to use!	50
• Choosing a pencil	51
• Attaching to a pencil	51
• Alligator clips	53
• Brushes	54
• Inspirational videos	54
Download	54
• Files for v1.1	54
• Files for v1.0	55

Overview

Sketching with Hardware

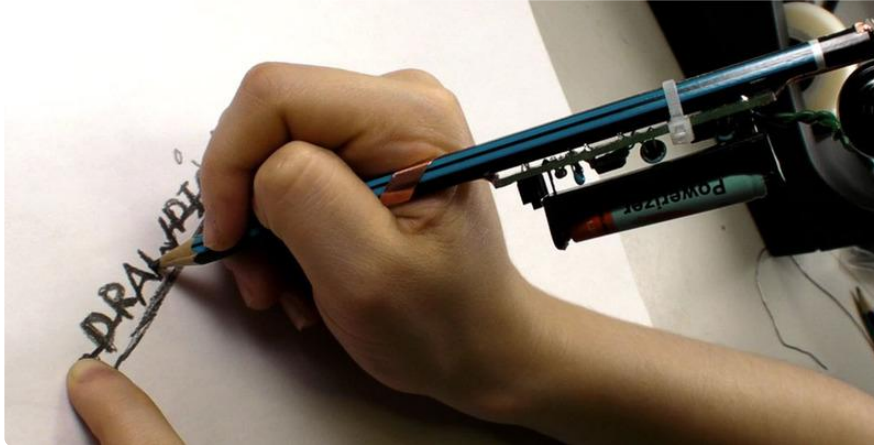

Drawdio: A pencil that lets you draw with music!

When I first saw the [Drawdio \(https://adafru.it/c1G\)](https://adafru.it/c1G) at Maker Faire I knew it would be a great project for beginners: A lot of fun with instant gratification! Essentially, its a very simple musical synthesizer that uses the conductive properties of pencil [graphite \(https://adafru.it/c1H\)](https://adafru.it/c1H) to create different sounds. The result is a fun toy that lets you draw musical instruments on any piece of paper.

- Runs on a single AAA battery for many hours (even 'nearly dead' batteries will work).
- Use any pencil - mechanical or plain. The kit comes with a 2B pencil, the softer the lead the better.
- Ridiculously fun for all ages!

Video!

The best way to see how Drawdio works is to watch a video...

Here are some videos from JJ Silver himself! These videos are of an earlier revision so it looks a little different.

Credits

The Drawdio kit was designed in collaboration with [Jay Silver \(https://adafru.it/c1I\)](https://adafru.it/c1I) & based on his [original design \(https://adafru.it/c1G\)](https://adafru.it/c1G)!

Design

How does it work?

The Drawdio kit is pretty simple compared to most electronic projects.

We will go through it one section at a time, please refer to the schematic.

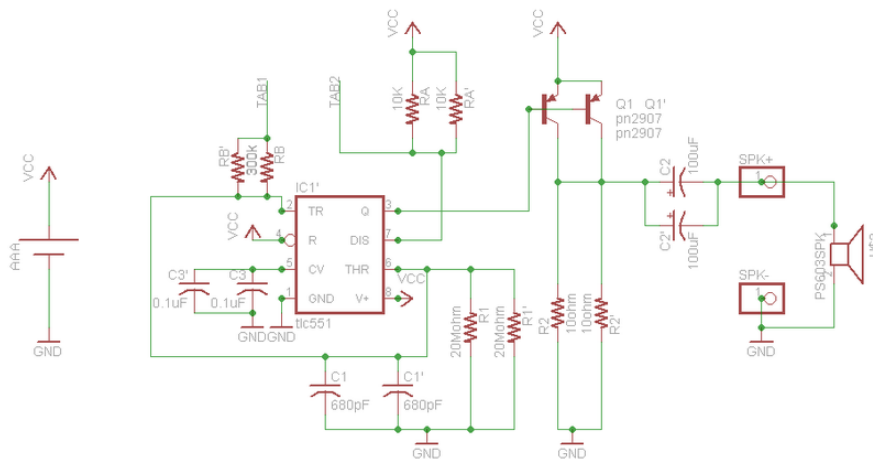

Power supply

The first part to understand is the power supply, which keeps everything running. The power source is a single AAA battery which is held in a plastic container that is soldered to the PCB. There is also a switch S1 which can connect or disconnect the battery from the rest of the circuit. Finally there is a large electrolytic capacitor C4, which is used as a 'bypass capacitor'. This means that it goes across the AAA battery and smooths out any ripples that are caused from power surges (like when the drawdio makes noise!)

The Oscillator

The heart of the kit is a TLC551 chip, which is a low voltage version of the famous [LM 555](https://adafruit.it/c1J) (<https://adafruit.it/c1J>) timer chip. This integrated circuit is specifically designed for creating timers and oscillators. The original LM555 needs at least 5V to run (which is more than 3 1.5 batteries!) so we are using the 551 which can run as low as 1V. It's a little more expensive but makes the whole thing fit on a pencil.

One of the more popular ways that '555s are used is as a 'astable multivibrator' which is another way of saying an oscillator. The frequency of the oscillation is set by 2 resistors and a capacitor. The chip slowly feeds current into the capacitor until it is full and then, likewise, slowly drains it out. The resistors set how fast to fill and drain the capacitor and the size of the capacitor indicates how long it takes before it fills.

This system is pretty much identical to Japanese water fountains, as this video shows:

Except its all with electrons instead of water molecules and capacitor C1 is the 'bucket'. The water fountain oscillates maybe once a minute (1/60 Hz). But electrons are so much faster, a '555 can oscillate at thousands of Hertz, which means it can make audible sound. (Human hearing tends to range from 20Hz to 20000 Hz.)

$$f = 1.44 / (C3 * (RA + 2 * RB))$$

$$C3 = 680 \text{ pF} = 0.00000000068 \text{ F}$$

$$RA = 10000 \text{ ohms}$$

$$RB = 300000 \text{ ohm to } 1000000 \text{ ohm (1 Mohm)}$$

In this case, we use two resistors RA and RB but also have an 'open connection': two tabs at the end of the PCB. If the two tabs are shorted with a piece of wire, then the frequency of the oscillation is 3500 Hz, if instead there is a resistor of 1 Megaohms between the two tabs, the frequency of oscillation is about 1000 Hz. You can use a calculator to do the math yourself using the formula above.

Instead of a 'everyday' resistor between the tabs, however, we use something else - the conductivity of the human body and graphite! The human body has a resistance similar to a 200,000 ohm resistor. Graphite has resistance of about 1 ohm per inch when it's in the form of a pencil lead. When it's spread out on a piece of paper, the resistance goes up a lot, up to a megaohm for a few inches of 'drawn resistor.'

Amplifier

The 551 can create audio-frequency oscillations but it is not powerful enough to play them on a speaker, just like an MP3 player needs an amp to play music on large speakers. That's because the 551 was designed mostly for digital logic, not for low impedance (8 ohm) audio outputs. So we will use a [Class B 'pushpull' amplifier \(https://adafru.it/c1K\)](https://adafru.it/c1K), which uses two separate transistors to amplify the sound.

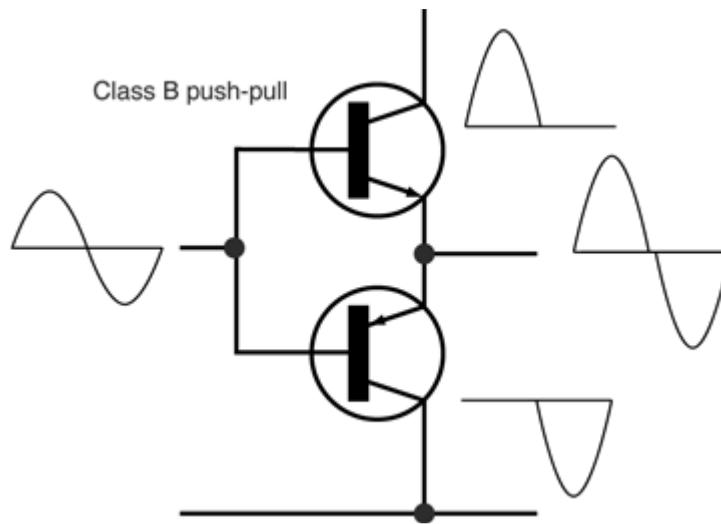

This is pretty much the same thing in your stereo, except your stereo has enormous transistors with gigantic heatsinks so that it can drive large speakers.

Make it!

Three step plan for success

This is a vey easy kit to make, just go through each of these steps to build the kit:

1. [Tools and preparation \(https://adafru.it/c1L\)](https://adafru.it/c1L)
 2. [Check the parts list \(https://adafru.it/c1M\)](https://adafru.it/c1M)
 3. [Assemble it \(https://adafru.it/c1N\)](https://adafru.it/c1N)
-

Preparation

[Learn how to solder with tons of tutorials! \(https://adafru.it/aTk\)](https://adafru.it/aTk)

[Don't forget to learn how to use your multimeter too! \(https://adafru.it/aOy\)](https://adafru.it/aOy)

Tools

There are a few tools that are required for assembly. None of these tools are included. If you don't have them, now would be a good time to borrow or purchase them. They are very very handy whenever assembling/fixing/modifying electronic devices! I provide links to buy them, but of course, you should get them wherever is most convenient/inexpensive. Many of these parts are available in a place like Radio Shack or other (higher quality) DIY electronics stores.



Soldering iron

Any entry level 'all-in-one' soldering iron that you might find at your local hardware store should work. As with most things in life, you get what you pay for.

Upgrading to a higher end soldering iron setup, like the [Hakko FX-888](http://adafru.it/180) that we stock in our store (<http://adafru.it/180>), will make soldering fun and easy.



Do not use a "ColdHeat" soldering iron! They are not suitable for delicate electronics work and can damage the kit (see here (<https://adafru.it/aOo>)).

[Click here to buy our entry level adjustable 30W 110V soldering iron \(http://adafru.it/180\).](http://adafru.it/180)

[Click here to upgrade to a Genuine Hakko FX-888 adjustable temperature soldering iron. \(http://adafru.it/303\)](http://adafru.it/303)

Solder

You will want rosin core, 60/40 solder. Good solder is a good thing. Bad solder leads to bridging and cold solder joints which can be tough to find.



[Click here to buy a spool of leaded solder \(recommended for beginners\) \(http://adafru.it/145\).](http://adafru.it/145)

[Click here to buy a spool of lead-free solder \(http://adafru.it/734\).](http://adafru.it/734)



Multimeter

You will need a good quality basic multimeter that can measure voltage and continuity.

[Click here to buy a basic multimeter. \(http://adafru.it/71\)](http://adafru.it/71)

[Click here to buy a top of the line multimeter. \(http://adafru.it/308\)](http://adafru.it/308)

[Click here to buy a pocket multimeter. \(http://adafru.it/850\)](http://adafru.it/850)



Flush Diagonal Cutters

You will need flush diagonal cutters to trim the wires and leads off of components once you have soldered them in place.

[Click here to buy our favorite cutters \(http://adafru.it/152\).](http://adafru.it/152)





Solder Sucker

Strangely enough, that's the technical term for this desoldering vacuum tool. Useful in cleaning up mistakes, every electrical engineer has one of these on their desk.

[Click here to buy a one \(http://adafru.it/148\)](http://adafru.it/148).

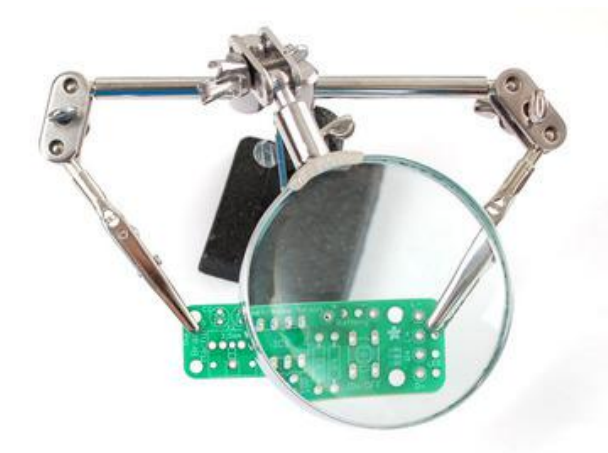

Helping Third Hand With Magnifier

Not absolutely necessary but will make things go much much faster, and it will make soldering much easier.

[Pick one up here \(http://adafru.it/291\)](http://adafru.it/291).

Parts list

Bill of Materials for v1.1

Check to make sure your kit comes with the following parts. Sometimes we make mistakes so double check everything and email support@adafruit.com if you need replacements!

Image	Name	Description	Information	Qty
-------	------	-------------	-------------	-----

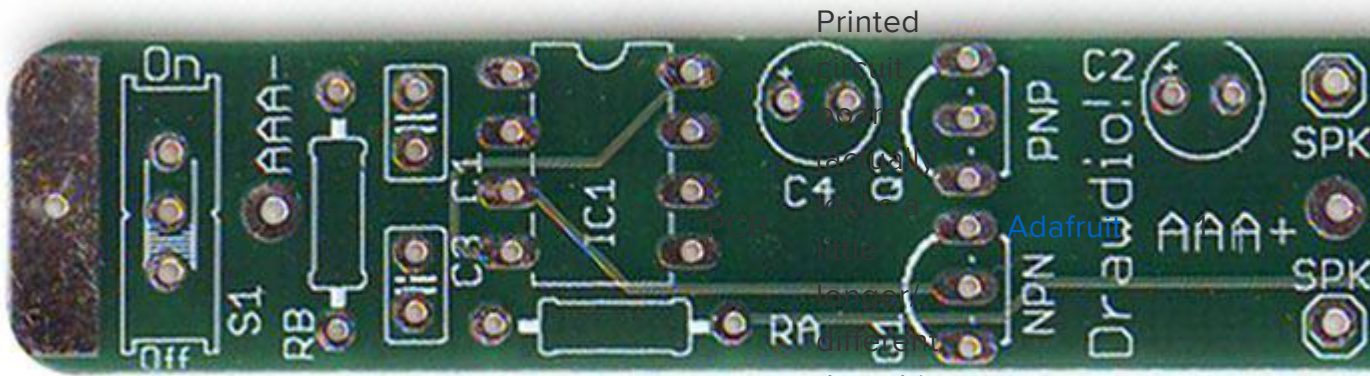

Printed

little longer/different than this one).

Adafruit



IC1

TLC551 or similar low voltage '555 timer chip.

[TLC551](#)

1

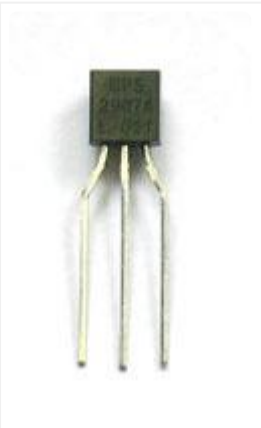

Q1

PNP transistor, EBC pinout

Such as PN2907 or 2N3806



[PN2907](#)

1

	C1 680pF ceramic capacitor	Generic	1
---	-------------------------------------	---------	---

	<p>C3</p> <p>0.1uF ceramic capacitor (104)</p>	<p>Generic</p>	<p>1</p>
--	--	----------------	----------

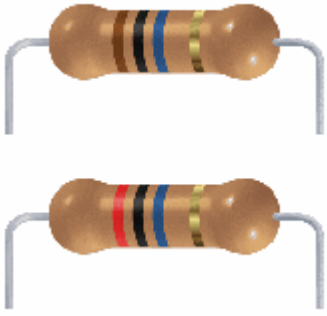
	<p>C2</p> <p>100uF / 6.3V capacitor (or higher)</p>	<p>Generic</p>	<p>1</p>
--	---	----------------	----------

	R1	<p>1/4W 5% 10 MEGAohm resistor</p> <p>Brown, Black, Blue, Gold</p> <p>OR</p> <p>1/4W 5% 20 MEGAohm resistor</p> <p>Red, Black, Blue, Gold</p> <p>If you don't have this part, you may have an older v1.0 kit see below!</p>	Generic	1
	R2	<p>1/4W 5% 10 ohm resistor</p> <p>Brown, Black, Black, Gold</p> <p>If you don't have this part, you may have an older v1.0 kit see below!</p>	Generic	1

	<p>RA</p> <p>1/4W 5% 10K resistor</p> <p>Brown, Black, Orange, Gold</p>	<p>Generic</p>	<p>1</p>
	<p>RB</p> <p>1/4W 5% 300K resistor</p> <p>Orange, Black, Yellow, Gold</p>	<p>Generic</p>	<p>1</p>







Small
8 Ohm
Speaker

Kobitone
PS603

1



Copper foil tape 3M 1181 6"

		Thumbtack	Any stationary store	1
		Pencil	Any stationary store	1
		Zip Tie	Any hardware store	1
		Wire	Any electronics or hardware store	6"

Bill of Materials for v1.0



Check to make sure your kit comes with the following parts. Sometimes we make mistakes so double check everything and email support@adafruit.com if you need replacements!

This is for the very old v1.0 kit, its unlikely you have this one but we will leave this up for historical record!

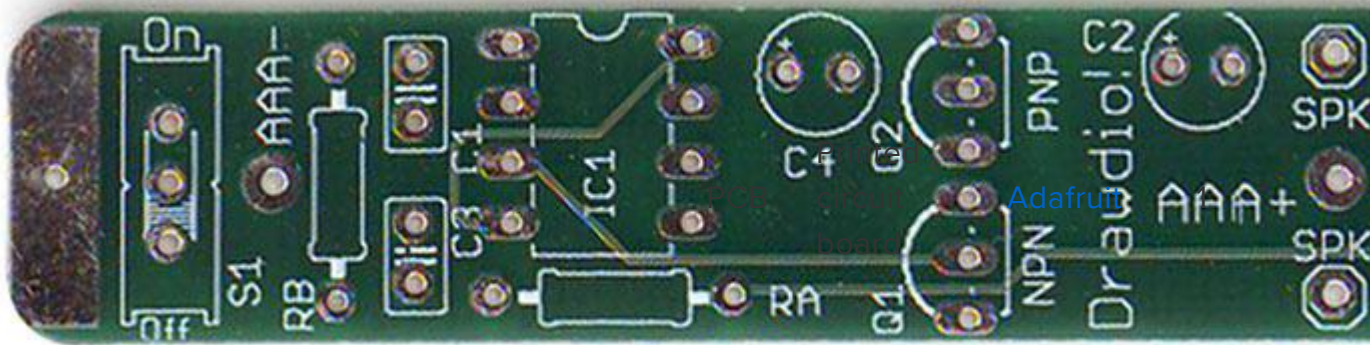
Image	Name	Description	Information	Qty
-------	------	-------------	-------------	-----



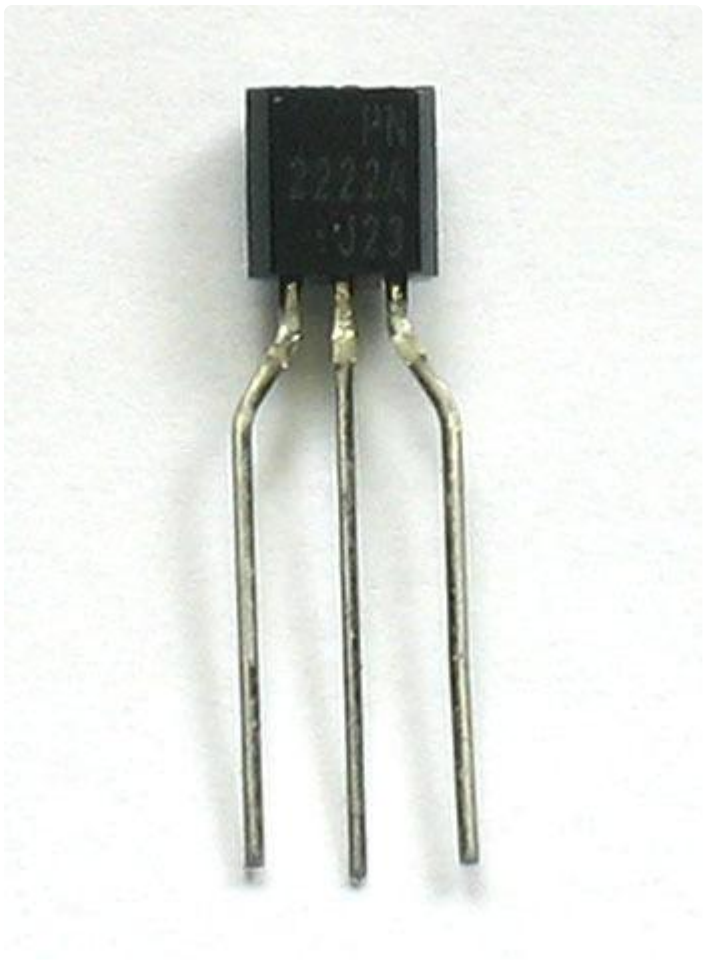

IC1	TLC551 or similar low voltage '555 timer chip	TLC551	1
-----	---	--------	---

	<p>Q1</p>	<p>NPN transistor, EBC pinout</p> <p>Such as PN2222 or 2N3904</p> <p>If you don't have this part, you may have a newer v1.2 kit see above!</p>	<p>PN2222</p>	<p>1</p>
	<p>Q2</p>	<p>PNP transistor, EBC pinout</p> <p>Such as PN2907 or 2N3806</p>	<p>PN2907</p>	<p>1</p>

	C1 680pF ceramic capacitor	Generic	1
---	-------------------------------------	---------	---

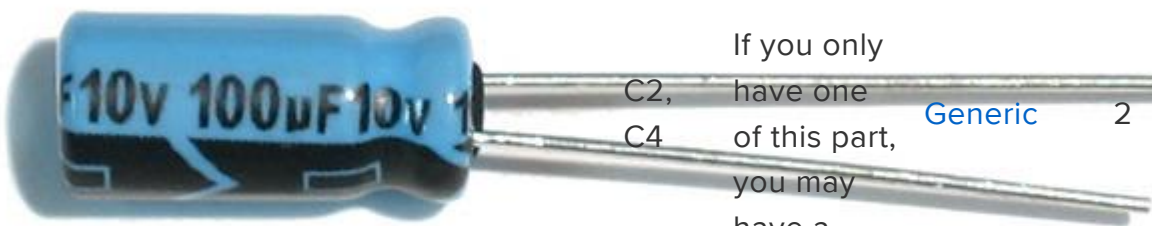
	<p>C3</p> <p>0.1uF ceramic capacitor (104)</p>	<p>Generic</p>	<p>1</p>
--	--	----------------	----------

	<p>100uF / 6.3V capacitor</p> <p>C2, C4</p> <p>If you only have one of this part, you may have a newer v1.2 kit see above!</p>	<p>Generic</p>	<p>2</p>
--	--	----------------	----------

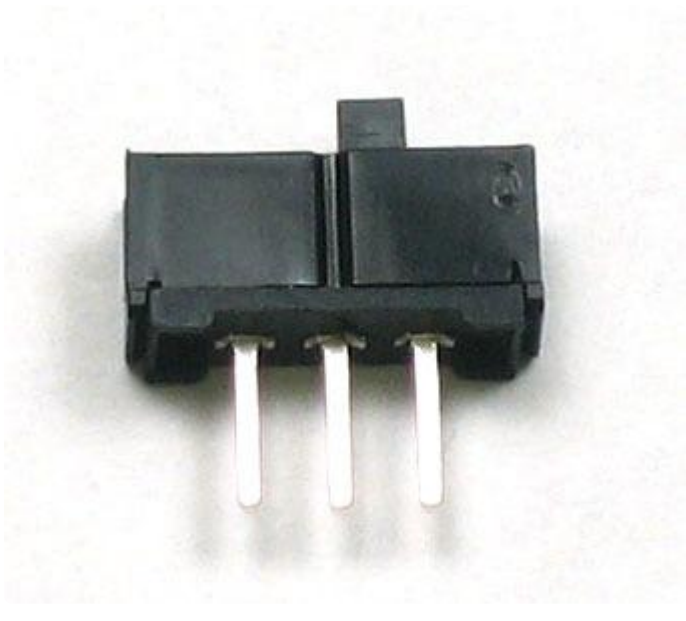
	RA	<p>1/4W 5% 10K resistor</p> <p>Brown, Black, Orange, Gold</p>	<p>Generic</p>	1
	RB	<p>1/4W 5% 300K resistor</p> <p>Orange, Black, Yellow, Gold</p>	<p>Generic</p>	1
	ON/ OFF	<p>Switch</p> <p>If you don't have this part, you may have a newer v1.2 kit see above!</p>	<p>E-Switch EG1218</p>	1



EPD BH412

holder





Small
8mm
Speaker

Kobitone
PS603

1



Copper foil tape 3M 1181 6"

		Thumbtack	Any stationary store	1
		Pencil	Any stationary store	1
		Zip Tie	Any stationary store	1
		Wire	Any electronics or hardware store	6"

Solder it!

Instructions for v1.1

These instructions are for the newer v1.1 kit with a thinner PCB and slightly different components. It makes minor upgrades to the kit which reduce power usage. If the photos don't match up, you probably have a v1.0 kit and [you should follow the instructions here!](https://adafru.it/c1O) (<https://adafru.it/c1O>)

Lets go!

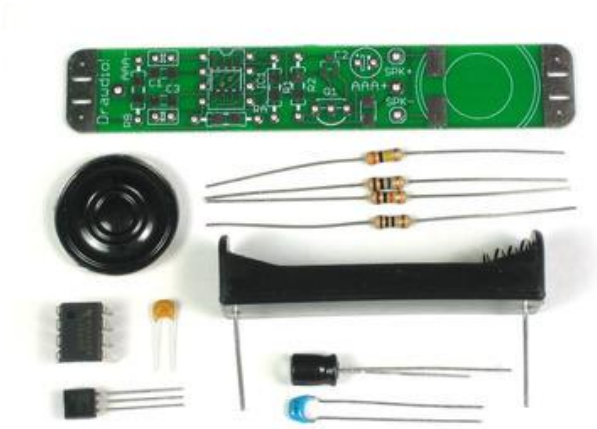

Make sure you have all the parts necessary. [Check the BOM \(https://adafru.it/c1M\)](https://adafru.it/c1M) for a list of everything in the kit.

These instructions are for the newer v1.1 kit with a thinner PCB and slightly different components. It makes minor upgrades to the kit which reduce power usage. If the photos don't match up, you probably have a v1.0 kit and [you should follow the instructions here! \(https://adafru.it/c1O\)](https://adafru.it/c1O)

Get ready by placing the PCB in a vise.

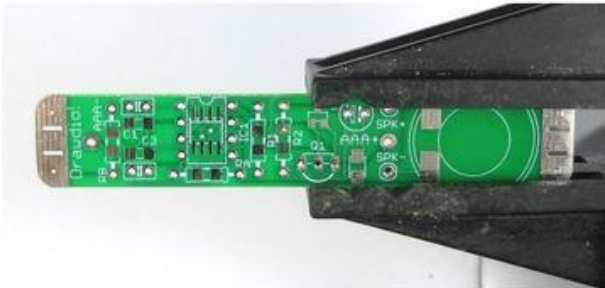

Heat up your soldering iron to 700deg F, clean the tip and make sure your sponge is wet.

Lets go!



First thing we will place is RA, a 10K resistor (brown, black, orange gold).

Bend the resistor into a staple as shown, and slip it in.

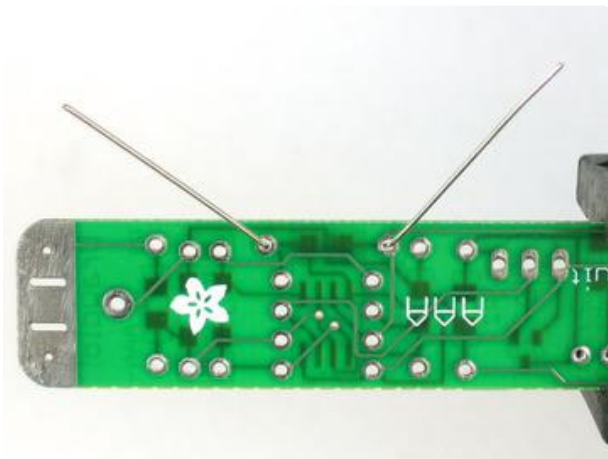
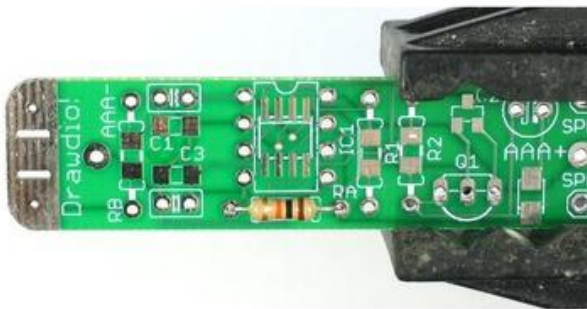

Place the resistor in the location marked RA. Resistors do not have polarity which means you can put it in 'either way' and it will work just fine. Bend the wire legs out so that the resistor sits flat against the PCB.

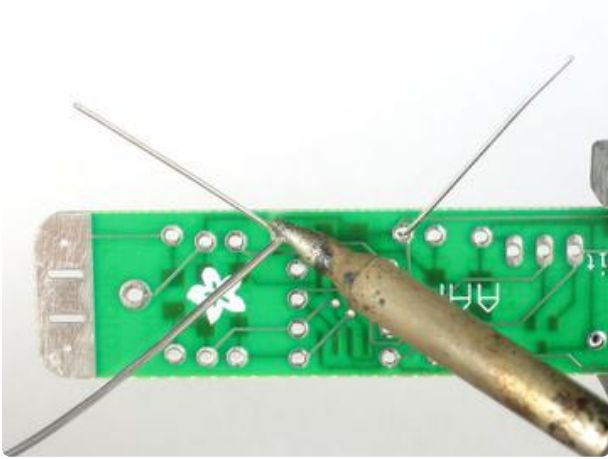

Turn the PCB over. Using your soldering iron tip, press and heat both the pad (the silver ring around the hole) and lead (wire) at the same time for 2 or 3 seconds. Then poke the end of the solder in to create a nice solder joint. Do this for both leads.

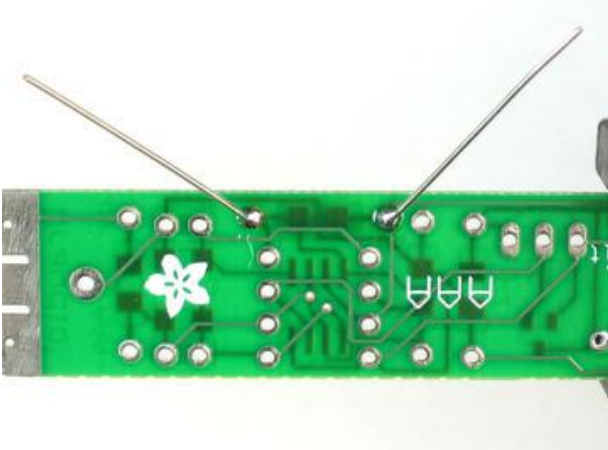
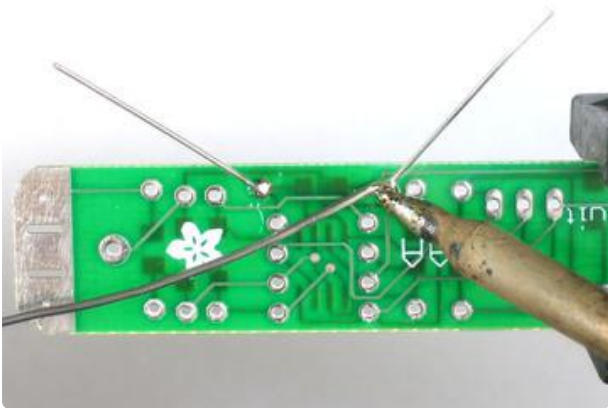

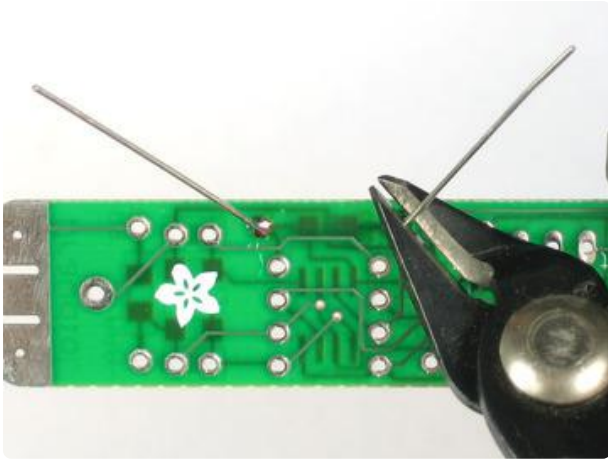

Using your diagonal cutters, cut off the long leads just above the solder joint.

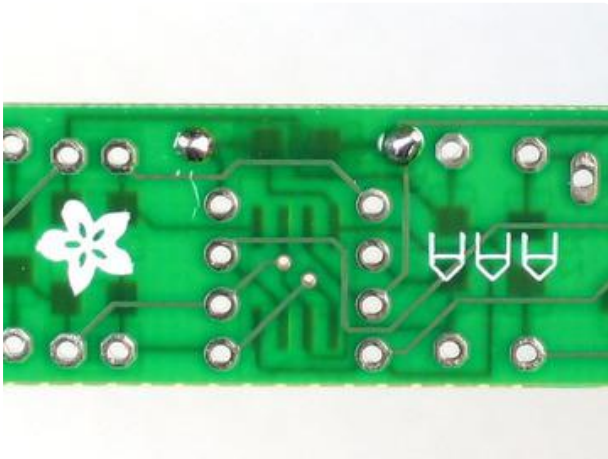

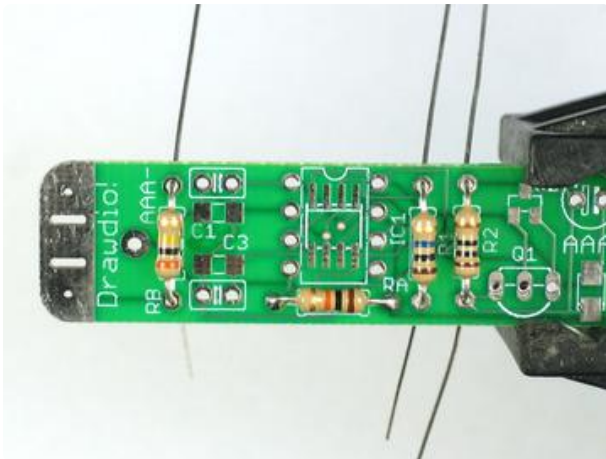

Next are the other 3 resistors.

Start with the resistor RB. This resistor has a different value, 300K. The stripes are Orange, Black, Yellow, Gold. Place that on the left, next to the RB silkscreen.

Then place R1 this is a 10 or 20 megaohm resistor! The stripes are brown, black, blue, gold or red, black, blue, gold. Make sure you do not confuse this with R2 which is a 10 ohm resistor. Look under a bright light to tell which one has a blue stripe and which one has a black stripe. If you're not sure, a multimeter will help measure the resistance.

Finally, place R2 which a 10 ohm resistor. The stripes are brown, black, black, gold. Make sure you do not confuse this with R1 which is a 10 megaohm resistor. Look under a bright light to tell which one has a blue stripe and which one has a black stripe. If you not sure, a multimeter will help measure the resistance.

Check again to make sure you did not confuse R1 and R2. Really, you need to look under a good light and a mistake here will be difficult to determine later!

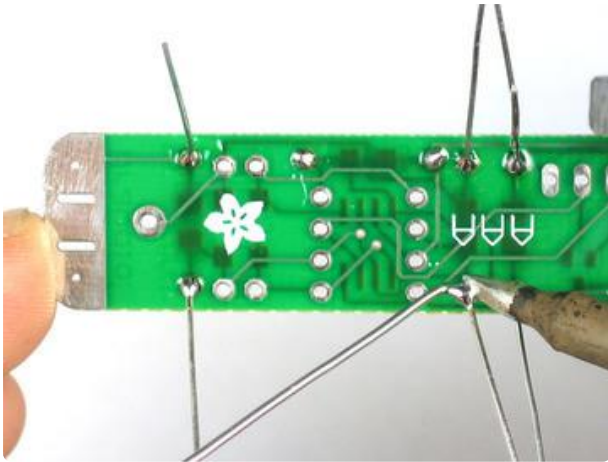

Once you are positive about R1 and R2, solder in these resistors using the same technique you used for the first resistor.

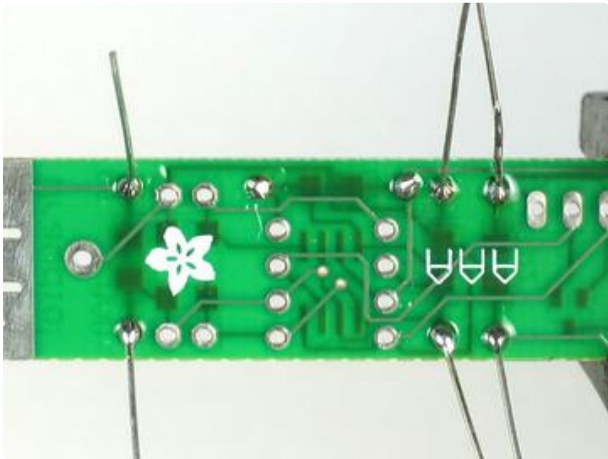

(oops forgot to take a photo here!)

Clip the resistors.

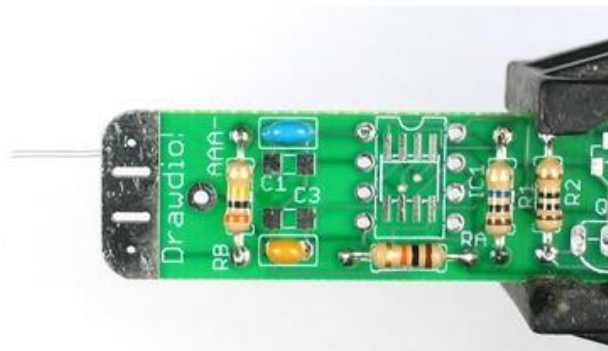

Next are the two ceramic capacitors C1 and C3. Ceramic capacitors also have a nice property that they are symmetric/ non-polarized. That means they can go in 'either way'. The capacitors are different values so make sure to not mix them up.

C3 is a yellow 0.1uF capacitor and has a "104" marking on it. C1 is the blue or orange 680pF capacitor and has a "681" marking on it.

Place the capacitors so that the 2 legs (leads) slide thru the two metal holes in the PCB (pads). The capacitor will sit flat against the PCB.

Solder in the capacitors.

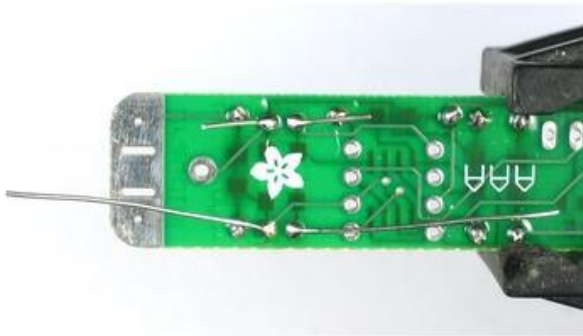
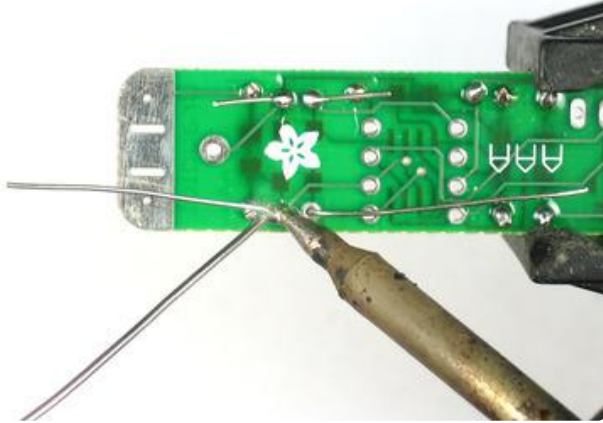

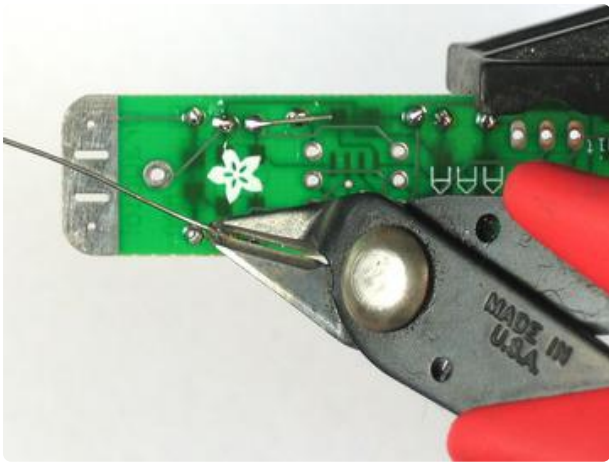

Clip the leads.

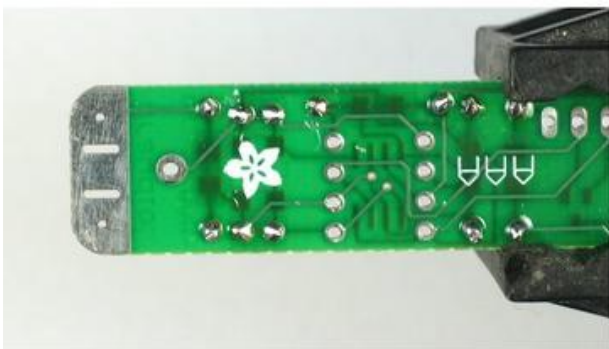

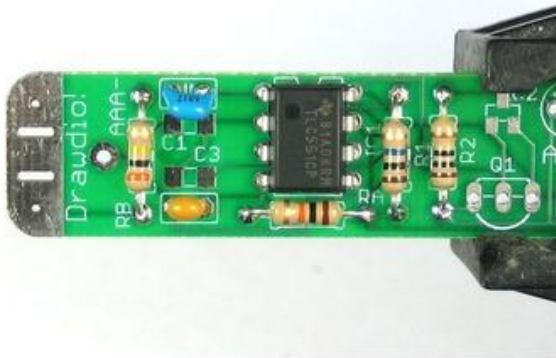

Next is the heart of the kit, a low voltage 555 timer chip. This one is called the TLC555. The important thing to note about the chip is that it is not symmetric. If it is put in wrong it will not work! Its also nearly impossible to fix if the chip goes in wrong so make triple-sure before you solder it in!

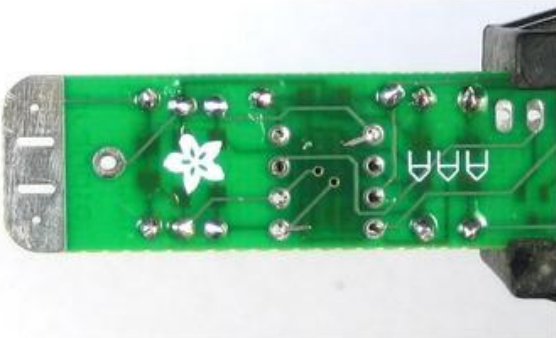

The silkscreen on the PCB has a little notch in the top. That notch indicates where the top of the chip is. If you look on the chip, there is a circle/dot imprinted in it on one end. There's also a TI logo at that side. Make sure the chip is inserted so that the top of the chip lines up with the silkscreen notch. Check the photo to the left if you're not sure.

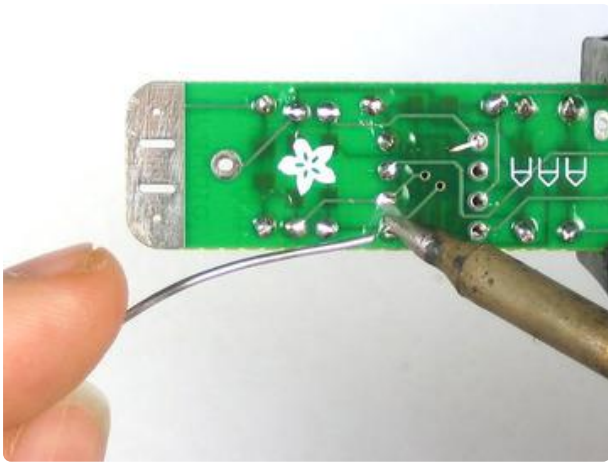

Solder in all 8 pins. You might want to use a piece of tape to hold the chip in place, or use a spare finger if you are dexterous.

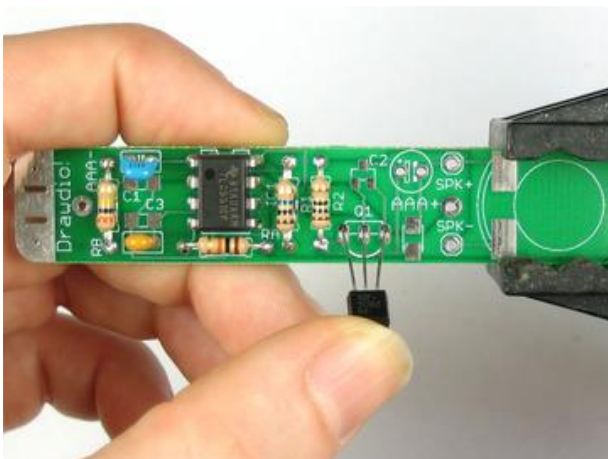
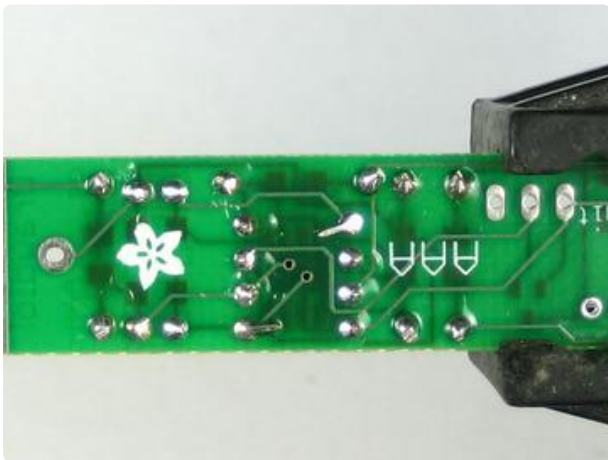
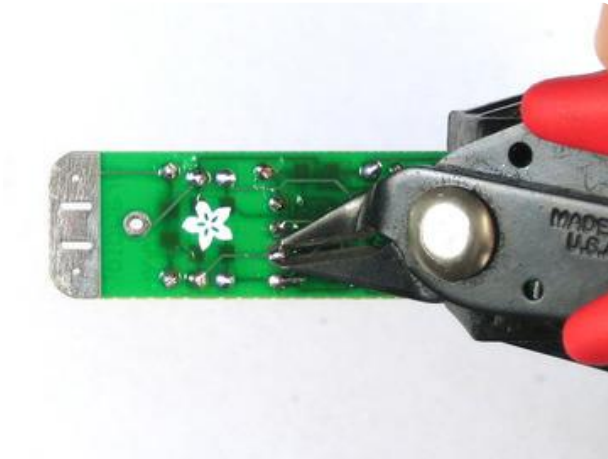

Next is the transistor amplifier Q1 which is PNP type

Make sure the shape of the transistor matches the silkscreen shape as shown.

Now bend over the transistor so its 'face flat' against the PCB.



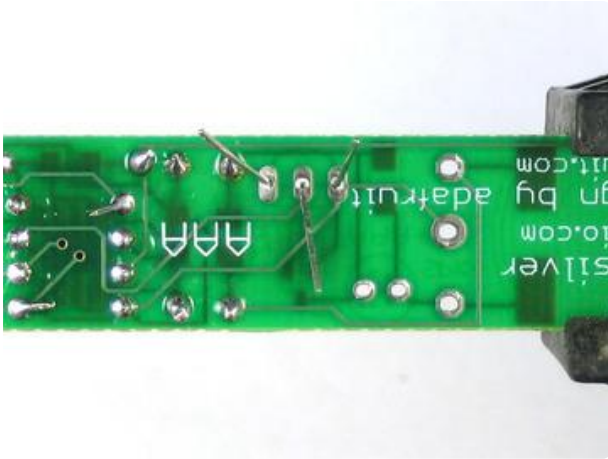

Flip over the PCB and solder it in.

Then clip the leads.

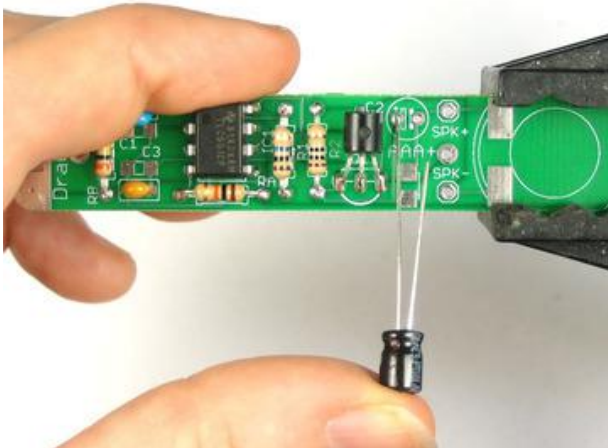
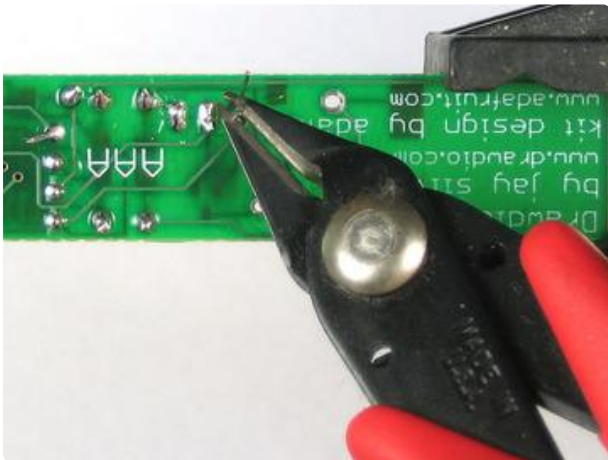
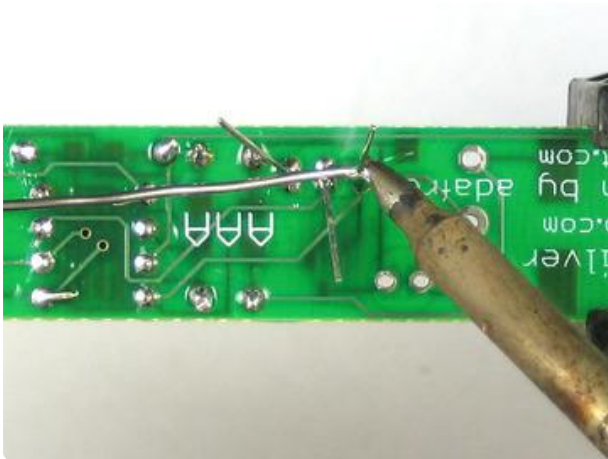

Next is the electrolytic capacitors C2

Electrolytic capacitors are polarized and must be placed correctly or the circuit will not work. The longer lead is the positive (+) one and must go into the pad marked with a + as shown.

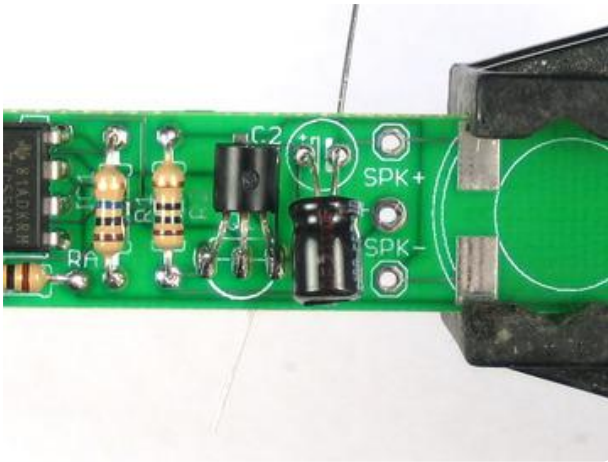

Fold the capacitor down so that it lies flat against the PCB.

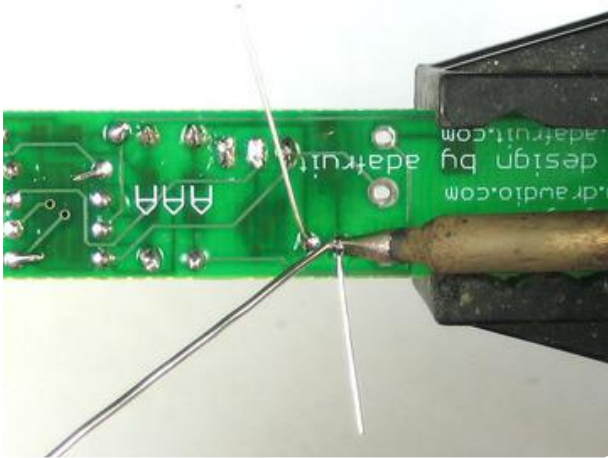

Solder them in, and clip the leads.

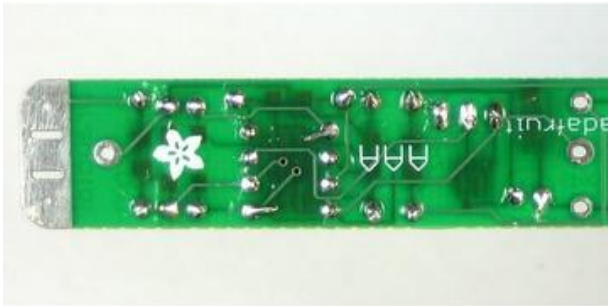

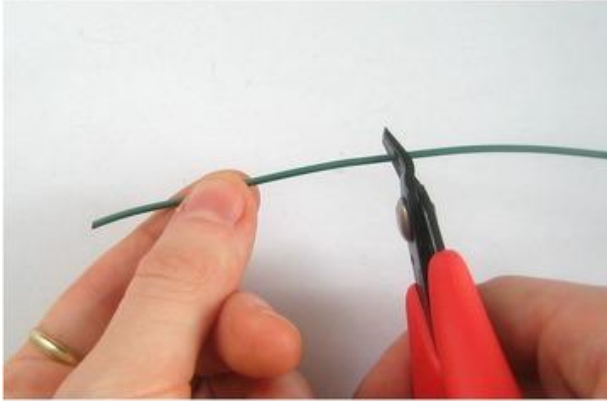

The electronic components are soldered in, next it is time to attach the speaker.

There are two ways to go about it. I will show the easier version first which uses wires to attach the speaker. Then I will show the 'more elegant' but difficult version where the speaker is attached directly to the PCB.

Use the diagonal cutters to clip off 2 2-3" pieces of wires.

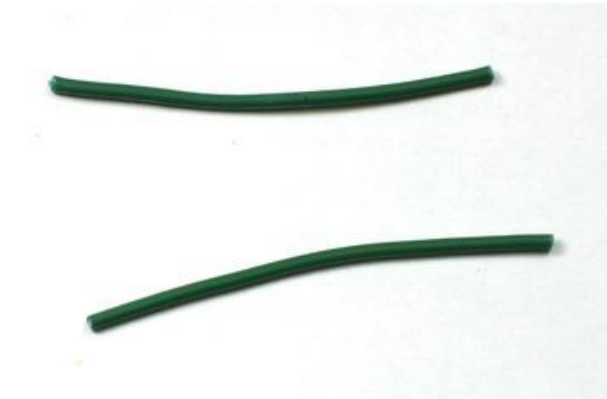

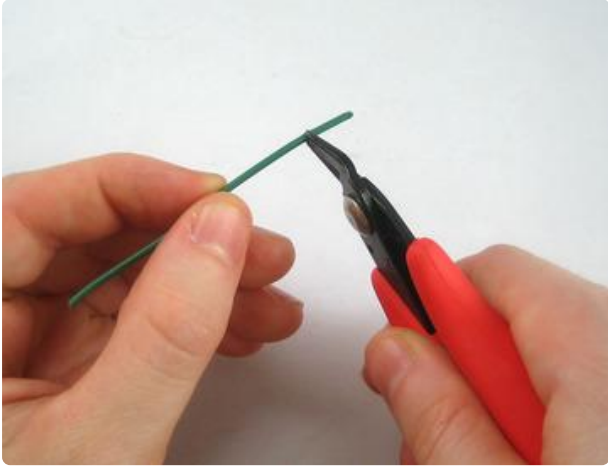

Next, nick the insulation 1/4" from the ends of the wire, and pull it off. If you have 'wire strippers', use them as they are a little easier!

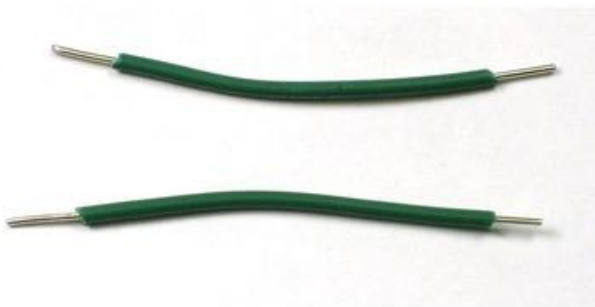
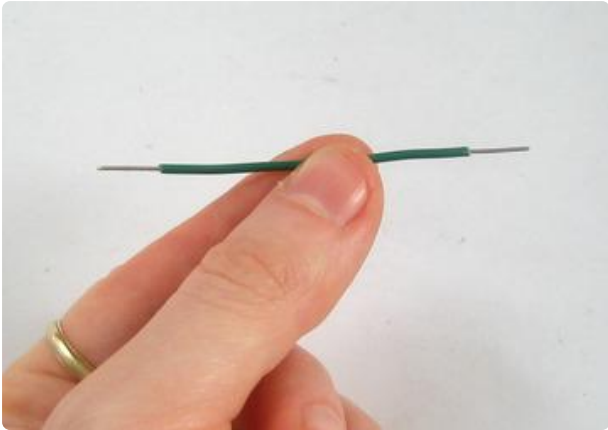
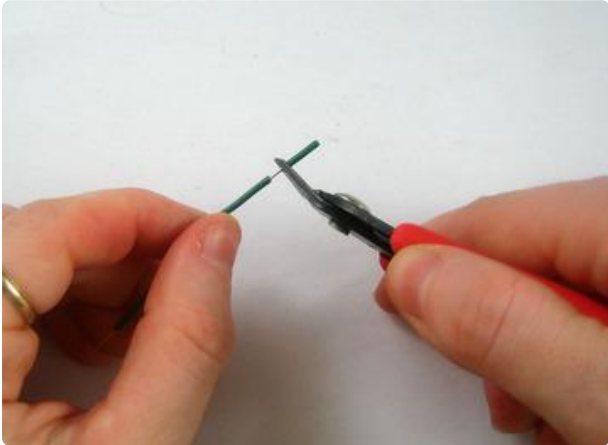

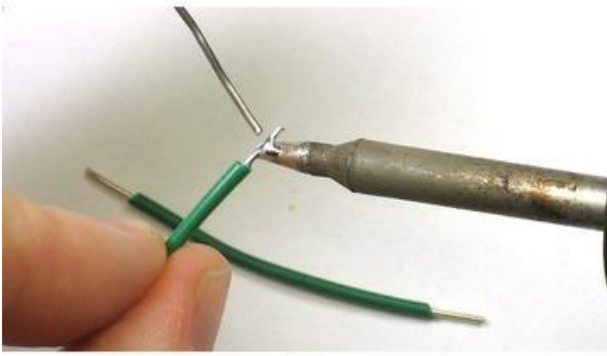

Next, it is a good idea to tin the ends of the wires. Its a little tricky because it requires holding three things. However, if you have a 'third hand tool' or a vise, you can use that to hold the wire while you heat up the stripped end and coat it with a little bit of solder. This will make it easier to connect to the speaker.

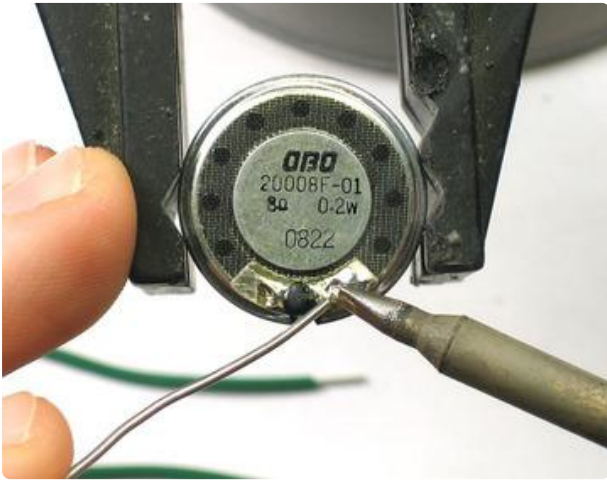

On the opposite side of the speaker there are two solder tabs. Heat them up and add a little more solder. Don't spend too much time on them (more than 3-4 seconds) since the speaker is made of plastic and if it heats up too much it will melt!

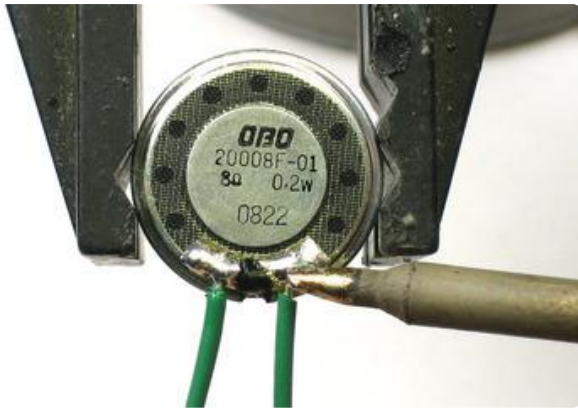

Next, warm up the tabs and slide the tinned ends of wire into the melted solder pool. Then remove the iron and wait a few seconds, the solder pool will cool with the wire in place. Do the same for the other pad.

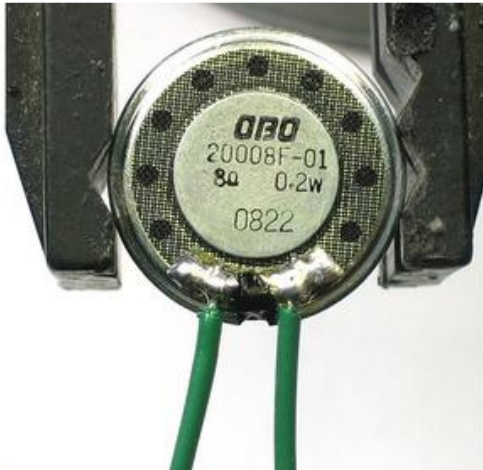

Twist the wires, this will reduce the strain on the solder joints when bending. Put the end of each wire into the two PCB holes marked SPK+ and SPK-. Don't solder into the hole in the middle which is for the battery. The speaker is 'symmetric' so it doesn't matter which wire goes in which hole.

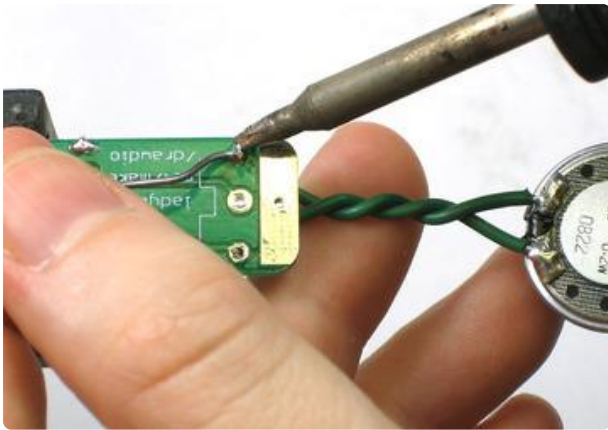

Solder the wires into place.



This is the more challenging way to attach the speaker but is a little more 'elegant' looking.

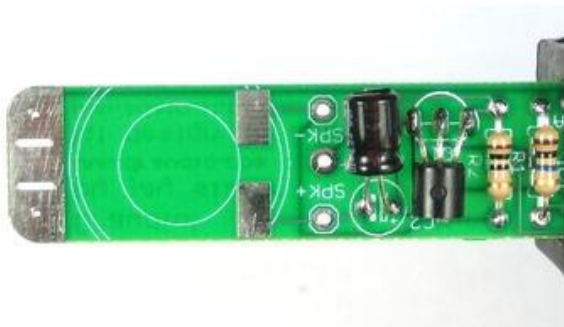

Prepare by finding the two big pads for the speaker.

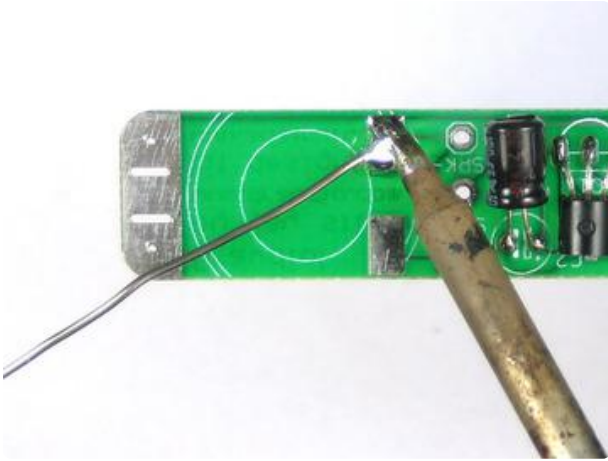

Now melt a lot of solder onto the two pads.

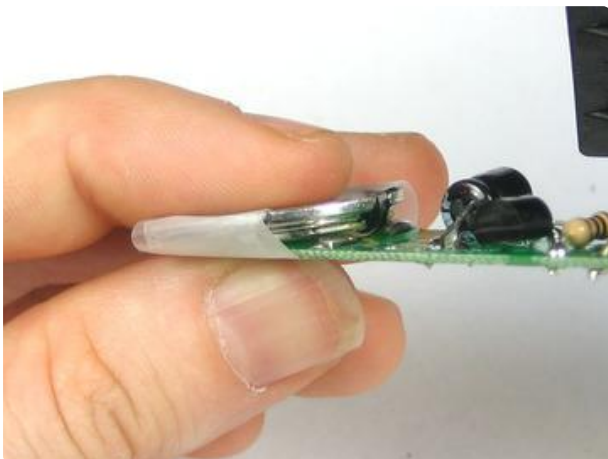
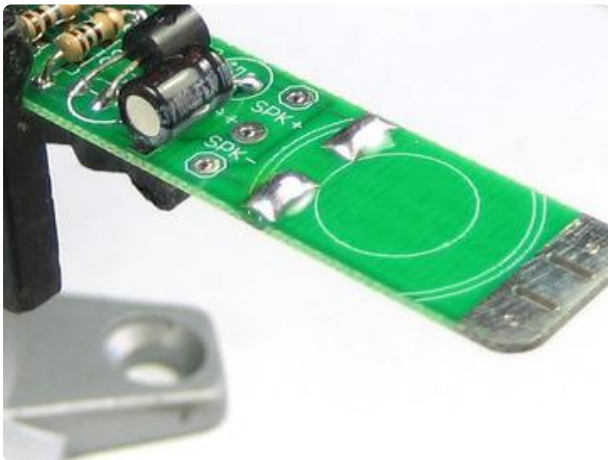
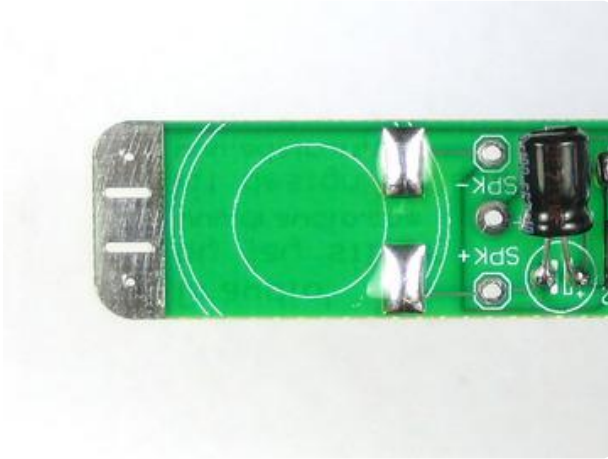

Tape or otherwise hold the speaker tabs against the blobs.

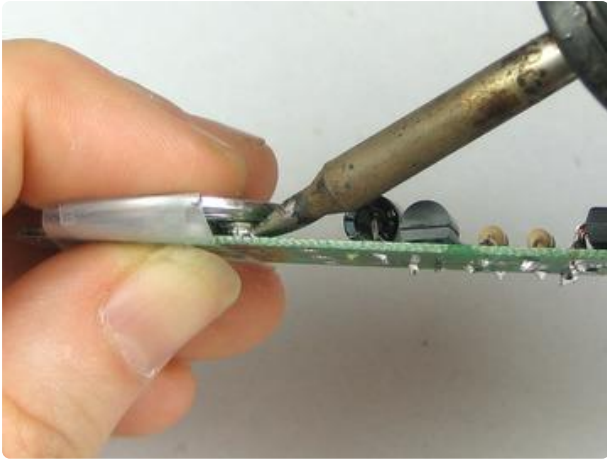

Now use the tip of your iron to quickly remelt the blobs so that they flow onto the speaker tabs.

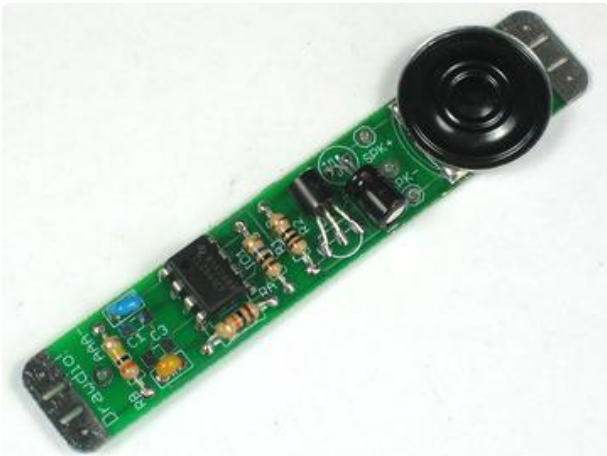

OK no matter which way you attached the speaker we will move to the next step.

Now its time to do a quick test before finishing up. Place a AAA battery in the holder.



Slide the battery holder into the PCB (but do not solder it in). Make sure that the battery is aligned correctly. Putting in the battery backwards shouldn't damage the circuit but it's still not a good idea so try to get it right the first time. The back of the PCB has a silkscreen to help determine which way the battery goes in.



With the battery holder in place (but, again, not soldered in) touch both sides of the PCB. A squeaking noise should come out of the speaker! As you press harder/softer, the pitch will change. That indicates the circuit is working.

If its not making noise, try:

1. Wiggle the battery holder a little to make sure it's making contact.
2. Check that the switch is turned on.
3. Check that the components are correctly placed and soldered well. Re-touchup the solder points in case you have cold solder joints.

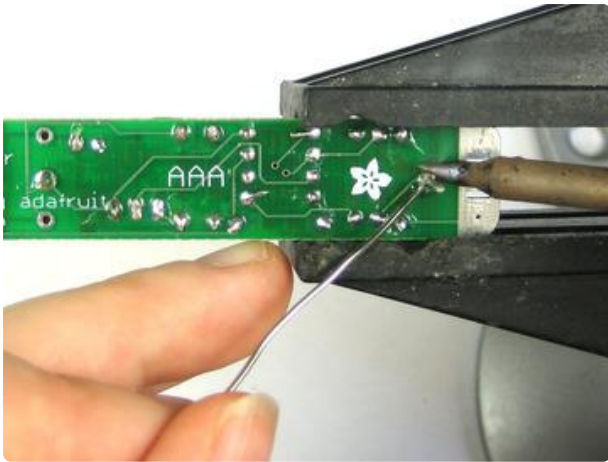

Once you are tested and happy, its time to finish up!

Remove the battery and place the battery holder on top of the components, as shown. Bend the leads a little so that it sits as tight as possible.

Solder in the battery holder, and clip the leads short.

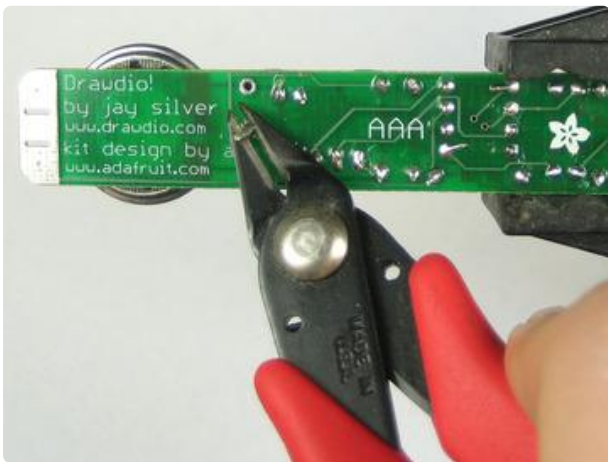

Next you can mount the PCB to your pencil. Place the PCB on the flat side of a pencil, and thread the zip tie through as shown and tighten it. You'll want it about an inch or less from the top of the pencil. The higher it is the more pencil you'll have to sharpen but it may be a little more unbalanced.

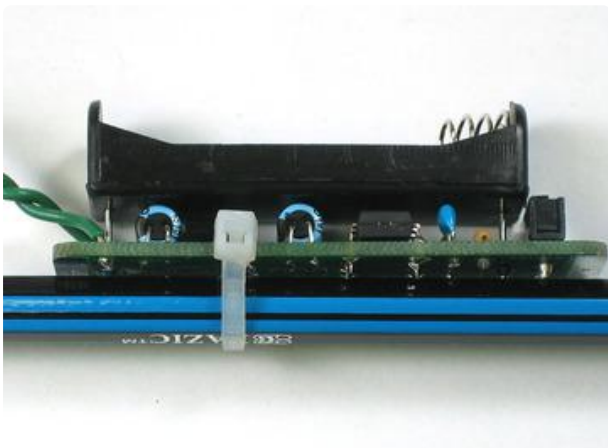

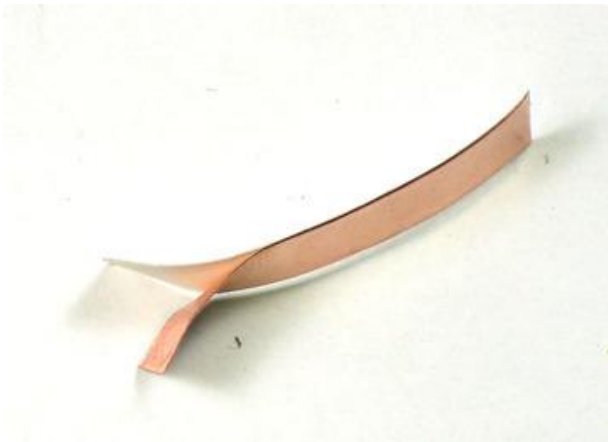

Next cut a 1.5" piece of copper tape using the diagonal cutters. Don't use scissors as the metal tape can damage them. Peel off the paper backing. The copper tape is conductive, sticky and flexible which makes it perfect for wrapping the pencil.



Wrap the tape along the top of the pencil so that the beginning is at the silver metal tab on the PCB, as shown.

While you don't have to solder the tape to the metal pad, it doesn't hurt and it can sometimes give you a better connection so feel free to!



Then take the thumbtack and gently push it into the end of the pencil. You might have to twist it back & forth a little to get it all the way in. The thumbtack will grip the copper tape and also make contact with the graphite in the middle of the pencil to make the first half of the drawing sensor.

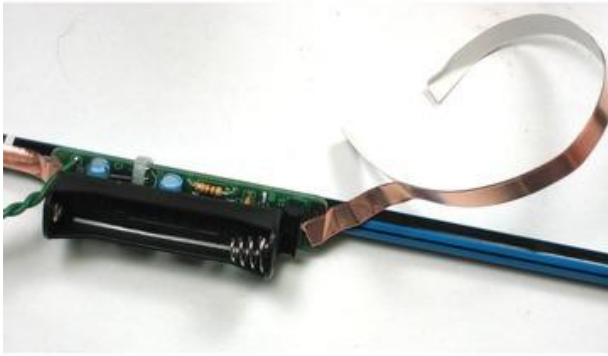

Next take 3 or 4" of copper tape and start wrapping around the bottom of the pencil, starting with the silver tab on the PCB and ending an inch before the end of the pencil. This will make contact with your hand and provide the second half of the sensor.

While you don't have to solder the tape to the metal pad, it doesn't hurt and it can sometimes give you a better connection so feel free to!

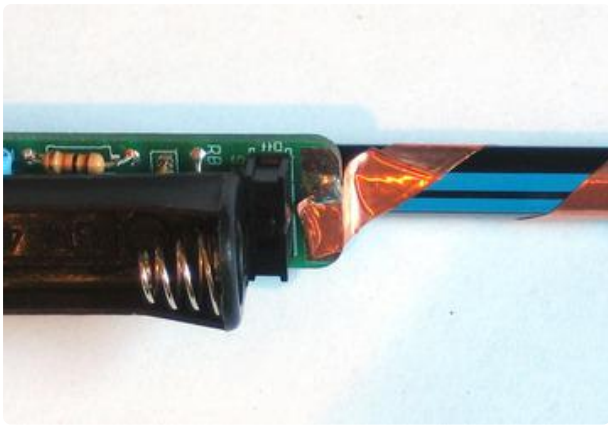

Solder the copper tape to the tab directly as shown.



Finally, insert a battery into the kit. Then grip the pencil with one hand and touch the point of the pencil to your other hand. You will be able to hear the drawdio make noise!

Next up, see the user manual for ideas on how to make the most of your drawdio.

Use it!

Ideas for experimentation

- Try different kinds of paper, and pencils. Mechanical pencils are great, but require a little more work. Check [drawdio.com \(https://adafru.it/c1G\)](https://adafru.it/c1G) for more information.
- Place a copper coin (like a penny!) on the drawing and use that to make contact with the graphite - it will make the surface area larger and reduce the resistance of the drawing.
- Hold hands with someone and 'draw' on their skin with the pencil.
- Wash and lightly dry your hands to make them a little more wet than usual, this will also affect the pitch.
- Use graphite slugs, available at an art store, instead of a pencil.
- Just hold on to both sides and try twisting and pressing to make different tones.

How to use!

The Drawdio is simple to use. Simply grip the pencil in one hand so that you're making good contact with the copper tape. Then draw a circle on the paper and touch it using a finger from the other hand.

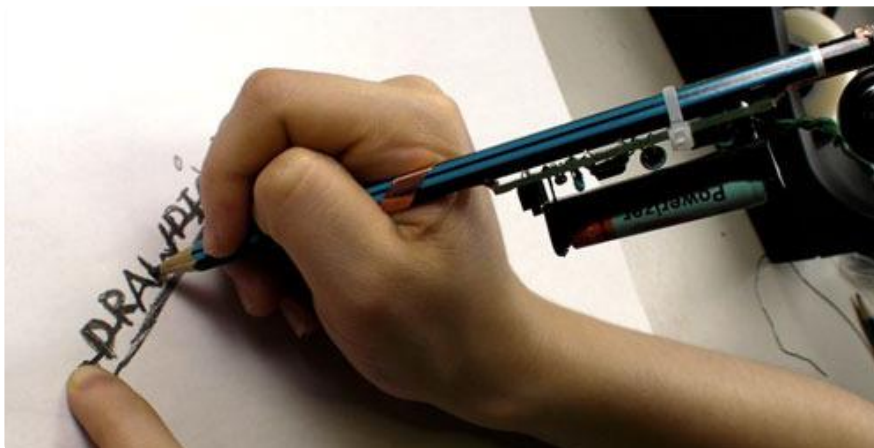

This allows your body to act as the sensor. The voltage is very low (about 1 volt) which is very safe. As long as you stick to the single battery, there are no health risks.

Using a copper coin between your finger and the graphite will improve the conductivity. Washing your hands and then drying them will also help, especially if you have drier skin or live in a dry climate.

Choosing a pencil

The 'softness' of the pencil lead will affect how thick the drawn lines are and thus the sound of the pencil. Experiment with hard and soft leads as well as sharpening or blunting the point to see how that affects the drawdio sound.

Mechanical pencils also work well. However, you may have to put an insulative layer (like packing tape) on the lower section of the pencil if the body is completely metallic.

Attaching to a pencil



You can mount the drawdio to your pencil. Place the PCB on the flat side of a pencil, and thread the zip tie through as shown and tighten it. You'll want it about an inch or less from the top of the pencil. The higher it is the more pencil you'll have to sharpen but it may be a little more unbalanced.

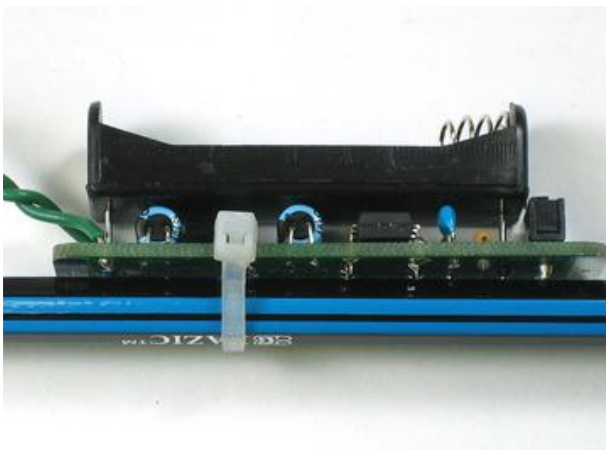

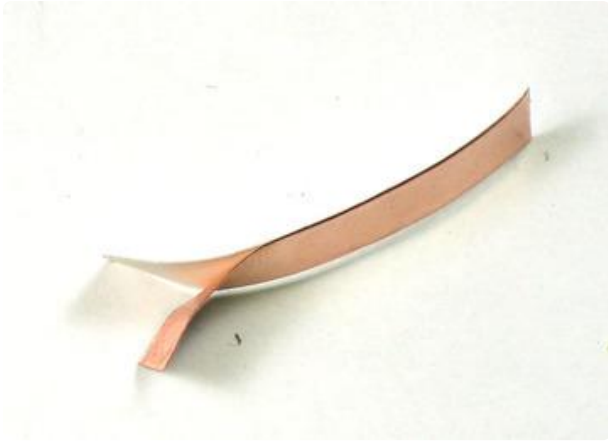

Next cut a 1.5" piece of copper tape using the diagonal cutters. Don't use scissors as the metal tape can damage them. Peel off the paper backing. The copper tape is conductive, sticky and flexible which makes it perfect for wrapping the pencil.

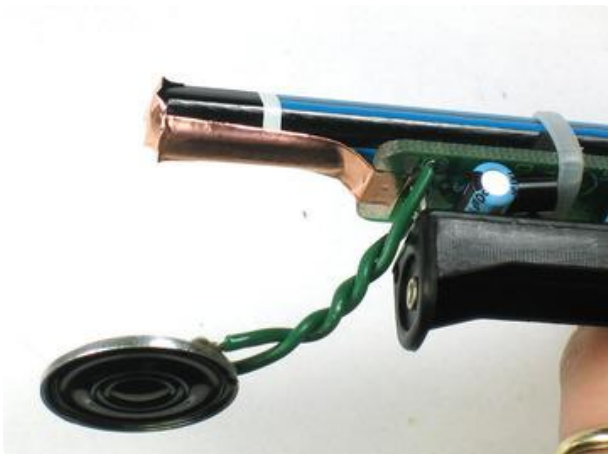

Wrap the tape along the top of the pencil so that the beginning is at the silver metal tab on the PCB, as shown.

Then take the thumbtack and gently push it into the end of the pencil. You might have to twist it back & forth a little to get it all the way in. The thumbtack will grip the copper tape and also make contact with the graphite in the middle of the pencil to make the first half of the drawing sensor.



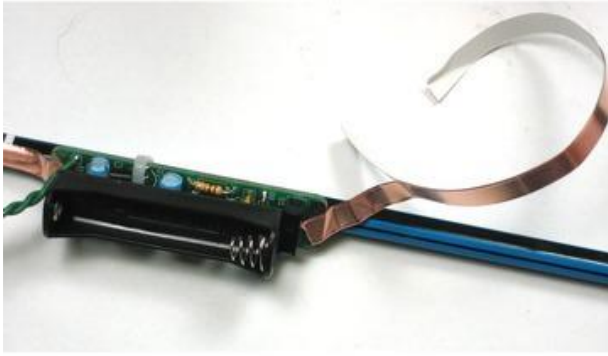

Next take 3 or 4" of copper tape and start wrapping around the bottom of the pencil, starting with the silver tab on the PCB and ending an inch before the end of the pencil. This will make contact with your hand and provide the second half of the sensor.



Finally, insert a battery into the kit. Then grip the pencil with one hand and touch the point of the pencil to your other hand. You will be able to hear the drawdio make noise!

Alligator clips

You can crimp on alligator clips to the end to allow attachment to all sorts of things like fabric, paper, clothing...anything but skin! Click on the photo for a larger version.



Brushes

You can also use a brush. We suggest paint or water with a little bit of salt dissolved in it, to improve the conductivity. Since the brushes have a plastic coating on the metal collar, you need to wrap the copper tape around the bristles themselves, as shown here. Click on the photo for a larger version.



Inspirational videos

And some from happy & noisy customers!

Download

Files for v1.1

These files are released CC Attrib. / Share-Alike

- [Schematic \(https://adafru.it/cmr\)](https://adafru.it/cmr) and [Board layout \(https://adafru.it/cms\)](https://adafru.it/cms) in EagleCAD format
- [Schematic in PNG \(https://adafru.it/cmt\)](https://adafru.it/cmt)

Files for v1.0

These files are released CC Attrib. / Share-Alike

- [Schematic \(https://adafru.it/cmu\)](https://adafru.it/cmu) and [Board layout \(https://adafru.it/cmv\)](https://adafru.it/cmv) in EagleCAD format
- [Schematic in PNG \(https://adafru.it/cmw\)](https://adafru.it/cmw)

Mouser Electronics

Authorized Distributor

Click to View Pricing, Inventory, Delivery & Lifecycle Information:

[Adafruit:](#)

[124](#) [197](#)