

EVAL-PS-IRS200x-OM30118SB User Manual

IRS2005S/IRS2007S/IRS2008S drive board for stepper motor

About this document

Scope and purpose

This application note provides an overview of the evaluation board [EVAL-PS-IRS200x-OM30118SB](#) concerning its main features, hardware description, thermal performance and typical waveforms, etc.

The EVAL-PS-IRS200x-OM30118SB board is a power drive board including driver ICs, MOSFETs, power connector and signal interface. The board is intended specifically for, but not limited to, stepper motor drives connected to an external stepper-motor controller board.

The board aims to boost Infineon's newly promoted 200 V PNJ series (PN-Junction Isolated) gate drivers [IRS2005S](#) (high and low-side drivers), [IRS2007S](#) (half-bridge driver), and [IRS2008S](#) (half-bridge driver).

Intended audience

This application note is intended for all technical specialists likely to evaluate the 200 V series PNJ gate drivers intended specifically for, but not limited to, stepper motor driving applications.

Table of contents







About this document	1
Table of contents	1
1 Safety precautions	2
2 Introduction	3
3 EVAL-PS-IRS200x-OM30118SB main features	4
3.1 EVAL-PS-IRS200x-OM30118SB board specifications	4
3.2 Pin assignment	6
4 Key components in the EVAL-PS-IRS200x-OM30118SB	7
4.1 200 V series PNJ gate driver	7
4.2 OptiMOS™3 IPP180N10N3 G	7
5 Getting started with the EVAL-PS-IRS200x-OM30118SB	8
5.1 Evaluate the driver IC on board	8
5.2 Running a stepper motor	10
6 Thermal analysis of the EVAL-PS-IRS200x-OM30118SB	13
7 Hardware description for the EVAL-PS-IRS200x-OM30118SB	15
7.1 Schematic diagram	15
7.2 PCB layout	16
8 Bill of material	19
9 Reference	21
Revision history	22

Safety precautions

1 Safety precautions

Please read carefully the following statements in Table 1 regarding hazards associated with the evaluation board and the testing system, in addition to the precautions listed throughout the manual.

Table 1 Safety precautions

	<p><i>Caution: The ground potential of the EVAL-PS-IRS200x-OM30118SB board is biased to a negative DC bus voltage potential. When measuring voltage waveform by oscilloscope, the scope's ground needs to be isolated. Failure to do so may result in personal injury or death, and equipment damage.</i></p>
	<p><i>Caution: Only personnel familiar with the drive and associated machinery should plan or implement the installation, start-up and subsequent maintenance of the system. Failure to comply may result in personal injury and/or equipment damage.</i></p>
	<p><i>Caution: The surfaces of the drive may become hot, which may cause injury.</i></p>
	<p><i>Caution: The EVAL-PS-IRS200x-OM30118SB board contains parts and assemblies sensitive to electrostatic discharge (ESD). Electrostatic control precautions are required when installing, testing, servicing or repairing this assembly. Component damage may result if ESD control procedures are not followed. If you are not familiar with electrostatic control procedures, refer to applicable ESD protection handbooks and guidelines.</i></p>
	<p><i>Caution: An incorrectly applied or installed drive can result in component damage or reduction in product lifetime. Wiring or application errors such as undersized motor, incorrect or inadequate DC supply, or excessive ambient temperatures may result in system malfunction.</i></p>
	<p><i>Caution: Remove or connect the control board from or to the power drive. Wait three minutes after removing power from the power drive to discharge the bus capacitors. Do not attempt to service the drive until the bus capacitors have discharged to zero. Failure to do so may result in personal injury or death.</i></p>
	<p><i>Caution: The EVAL-PS-IRS200x-OM30118SB board is shipped with packing materials that need to be removed prior to installation. Failure to remove all packing materials which are unnecessary for system installation may result in overheating or abnormal operating condition.</i></p>

Introduction

2 Introduction

Note: Evaluation boards are not subject to the same procedures as regular products regarding Returned Material Analysis (RMA), Process Change Notification (PCN) and Product Discontinuation (PD). Evaluation boards are intended to be used under laboratory conditions and by trained specialists only.

The power stage of the evaluation board EVAL-PS-IRS200x-OM30118SB consists of four phases with individual leg shunt, which is a popular topology for stepper motor driving. The input voltage 24~72 V_{DC} is available for most of the stepper motors on the market. The MOSFETs are selected with IPP180N10N3 G (100 V/18 mΩ), and driven by the 200 V series PNJ gate drivers IRS2005S/IRS2007S/IRS2008S accordingly.

Each phase leg current is sensed by the leg shunt, and exported to the control interface in differential mode. The board can run a stepper motor by connecting to an external controller. The board is originally soldered with the IRS2005S (positive logic inputs), and can be replaced by two other parts with the same footprint for different logic inputs (refer to Table 5).

The board is available via regular Infineon distribution partners as well as on Infineon's website. The features of this board are described in Chapter 3 of this document. The remaining sections provide information to enable customers to copy, modify and qualify the design for production according to their own specific requirements.

Environmental conditions were considered in the design of the EVAL-PS-IRS200x-OM30118SB. However, the board has not been qualified in terms of safety requirements, manufacturing and operation over the entire operating temperature range or lifetime. The boards provided by Infineon are subject to functional testing only.

Figure 1 depicts the block diagram of the EVAL-PS-IRS200x-OM30118SB. The shaded parts are those contained in the PCB. The auxiliary power supply V_{CC} has to come from the external input.

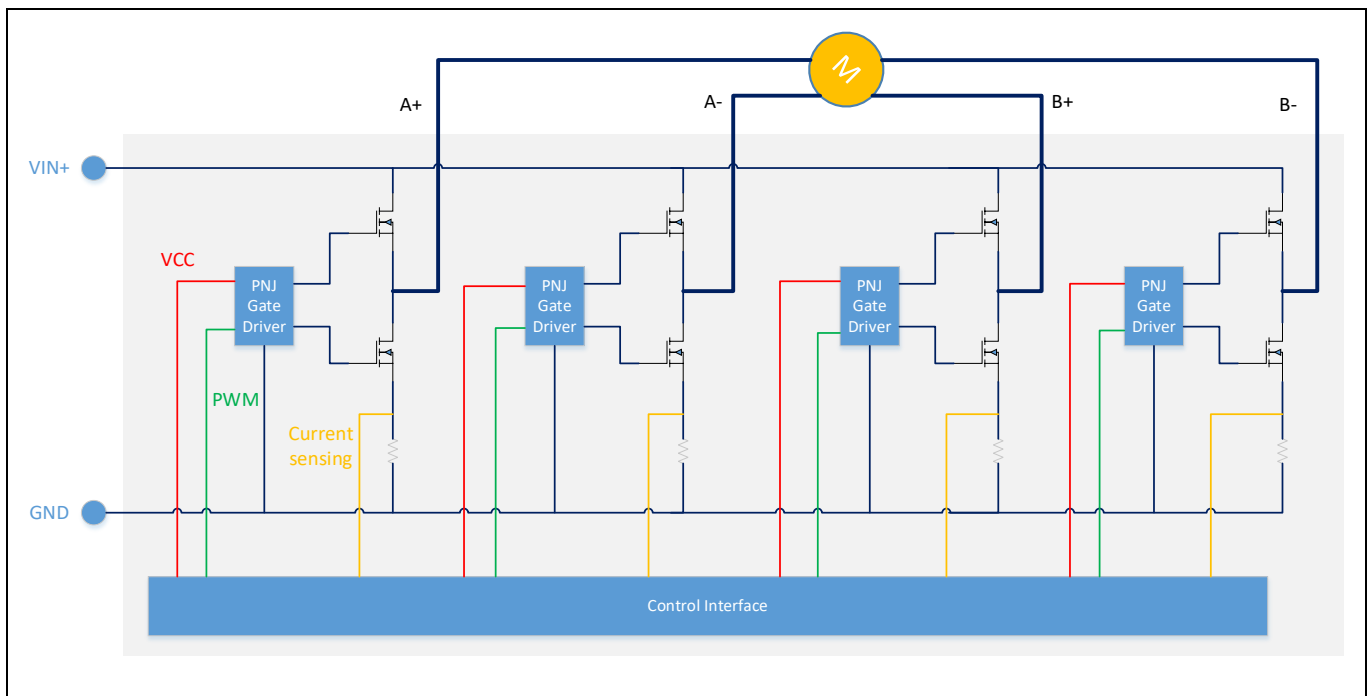

Figure 1 Block diagram of the EVAL-PS-IRS200x-OM30118SB

3 EVAL-PS-IRS200x-OM30118SB main features

The main features of the evaluation board EVAL-PS-IRS200x-OM30118SB are described as follows:

- Four-phase inverter with individual leg shunt, specifically for stepper motor driving
- Double-sized PCB supplies with a low-cost solution
- DC voltage input with fused protection in case of short circuit
- 200 V series PNJ gate driver IRS2005S/IRS2007S/IRS2008S with -8 V negative V_s capability for better ruggedness and different input PWM logics
- 100 V-rated OptiMOS™3 MOSFET IPP180N10N3 G with very low on-resistance (18 mΩ) for a better thermal performance
- The board can run a stepper motor by connecting to an external control board
- Externally imported auxiliary power supply via LED indication
- Natural ventilation with installed heatsink

3.1 EVAL-PS-IRS200x-OM30118SB board specifications

The detailed specifications of the EVAL-PS-IRS200x-OM30118SB are described in Table 2.

Table 2 EVAL-PS-IRS200x-OM30118SB board specifications

Parameters	Typical	maximum	Conditions / comments
Input			
Voltage (V_{DC})	24 / 48 / 72	72	VIN+ to GND
Current (I_{AVG})		3.0	@ 24 V_{DC} input and maximum phase-out current 7 A_{RMS}
Output			
Phase current (I_{RMS})		7	Set by the external stepper motor controller
Switching frequency			
Inverter frequency (kHz)	20		Set by the external stepper motor controller
Current feedback			
Current sampling shunt	10 mΩ		Leg shunt for each phase
Aux power supply			
Supply voltage (V_{DC})	12 / 15	20	From external power supply
System environment			
Ambient temperature	0~50 °C		Natural ventilation, maximum RH of 95 %
PCB characteristics			
Dimensions	Length*Width=86x79 mm ² , 2 layers, PCB thickness=2 mm, copper thickness=2 oZ		
Material	FR-4, RoHS-compliant		

*Note: IRS2001S/2003S/2004S are not recommended for new designs.
 IRS2001S/2003S/2004S can be directly replaced by IRS2005S/2007S/2008S respectively.*

EVAL-PS-IRS200x-OM30118SB User Manual
IRS2005S/IRS2007S/IRS2008S drive board for stepper motor
EVAL-PS-IRS200x-OM30118SB main features

The top and bottom view of the EVAL-PS-IRS200x-OM30118SB are shown in Figure 2 and Figure 3, respectively.

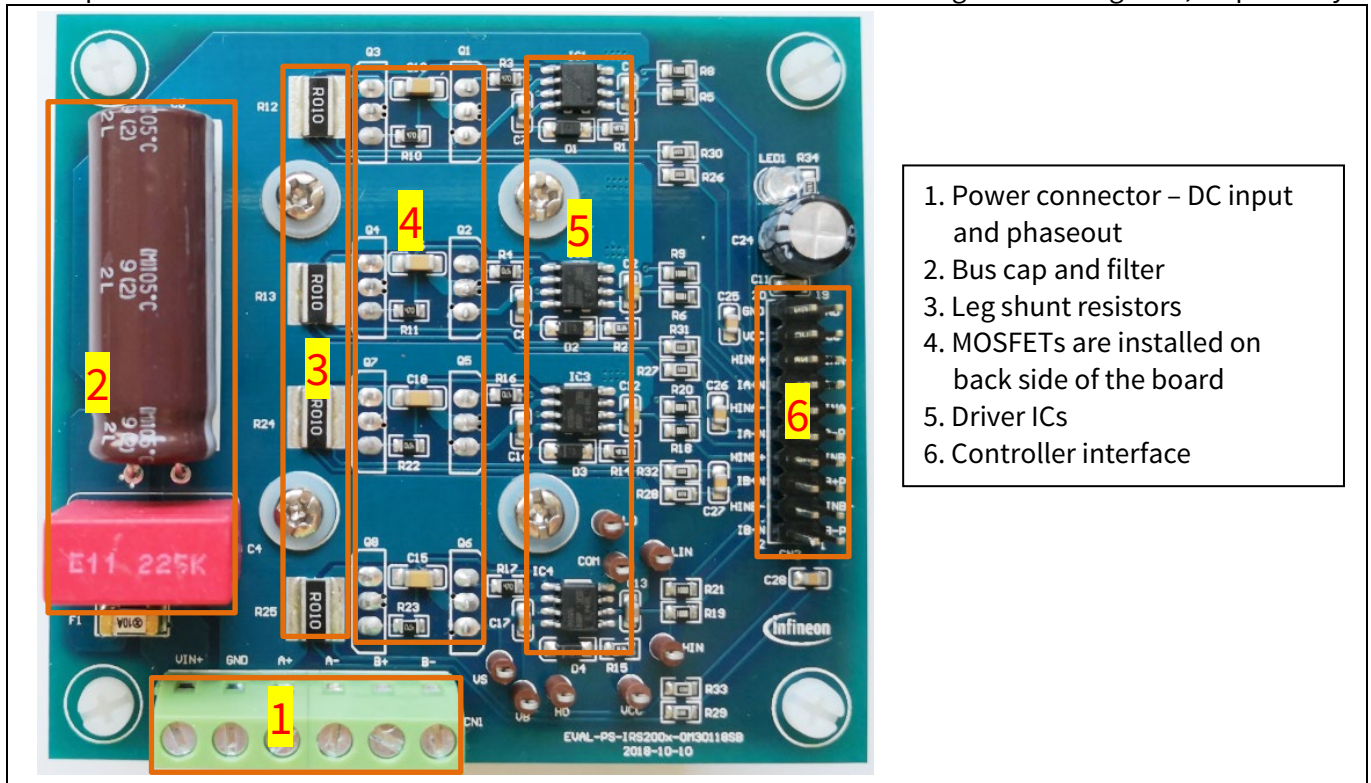

- 1. Power connector – DC input and phaseout
- 2. Bus cap and filter
- 3. Leg shunt resistors
- 4. MOSFETs are installed on back side of the board
- 5. Driver ICs
- 6. Controller interface

Figure 2 Top view of the EVAL-PS-IRS200x-OM30118SB

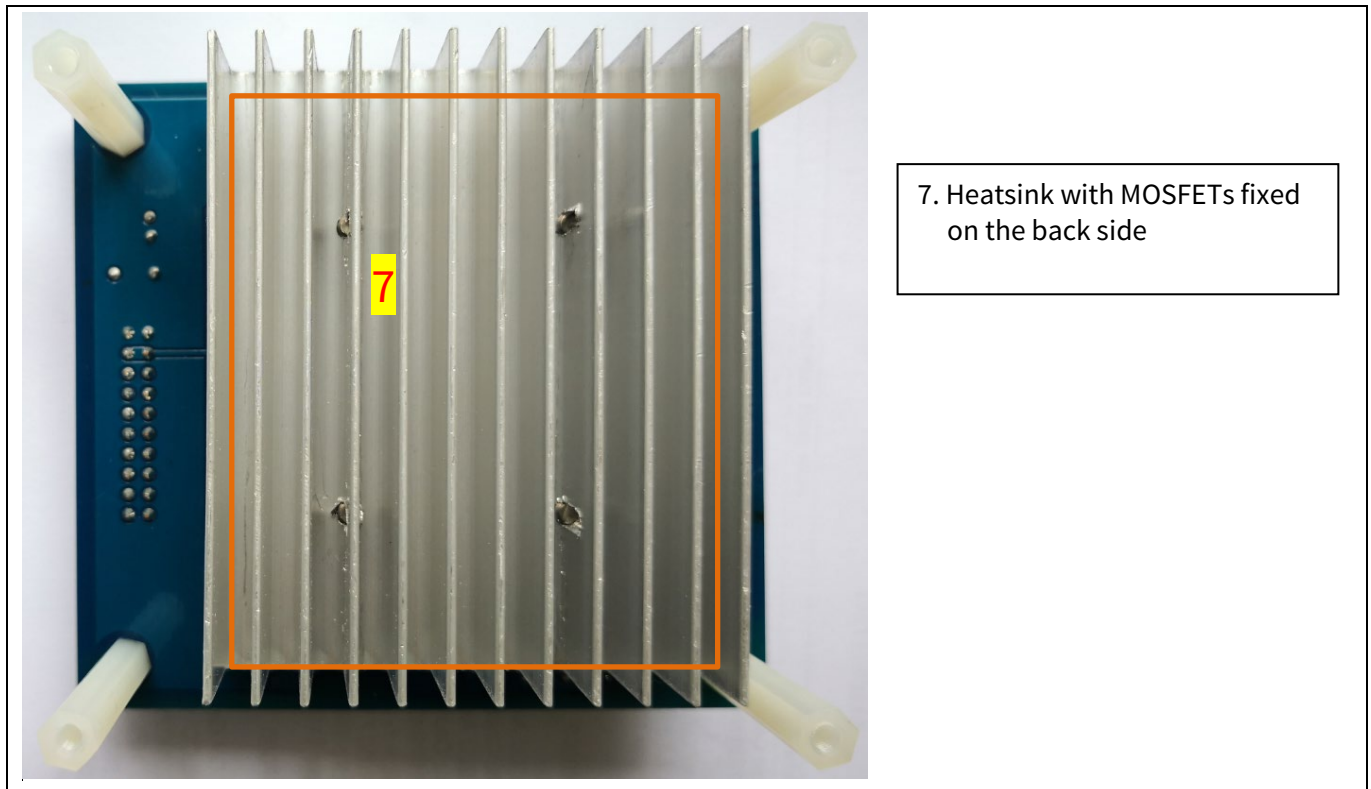

- 7. Heatsink with MOSFETs fixed on the back side

Figure 3 Bottom view of the EVAL-PS-IRS200x-OM30118SB

3.2 Pin assignment

The pin assignment of the power connector is listed in Table 3. The pin names are also marked on the PCB.

Table 3 CN1 – Power connector

S. No.	Pin name	Details
1	VIN+	Positive of the DC input
2	GND	DC input reference, system ground, driver IC ground
3	A+	Phase-out connecting to the stepper motor A+ terminal of winding A
4	A-	Phase-out connecting to the stepper motor A- terminal of winding A
5	B+	Phase-out connecting to the stepper motor B+ terminal of winding B
6	B-	Phase-out connecting to the stepper motor B- terminal of winding B

The pin assignment of the controller interface connector is listed in Table 4. The pin names are also marked on the PCB.

Table 4 CN2 – Controller interface

S. No.	Pin name	Details
1	IB-P	Positive B- phase leg shunt current sensing
2	IB-N	Negative B- phase leg shunt current sensing
3	LINB-	Low side PWM input for B- phase
4	HINB-	High side PWM input for B- phase
5	IB+P	Positive B+ phase leg shunt current sensing
6	IB+N	Negative B+ phase leg shunt current sensing
7	LINB+	Low side PWM input for B+ phase
8	HINB+	High side PWM input for B+ phase
9	IA-P	Positive A- phase leg shunt current sensing
10	IA-N	Negative A- phase leg shunt current sensing
11	LINA-	Low side PWM input for A- phase
12	HINA-	High side PWM input for A- phase
13	IA+P	Positive A+ phase leg shunt current sensing
14	IA+N	Negative A+ phase leg shunt current sensing
15	LINA+	Low side PWM input for A+ phase
16	HINA+	High side PWM input for A+ phase
17	VCC	Power supply of the driver ICs, from external DC auxiliary power supply
18	VCC	
19	GND	System ground, power supply reference
20	GND	

Key components in the EVAL-PS-IRS200x-OM30118SB

4 Key components in the EVAL-PS-IRS200x-OM30118SB

4.1 200 V series PNJ gate driver

The IRS2005S/IRS2007S/IRS2008S are newly promoted PNJ gate drivers, which include many improvements compared with the formerly used parts (see comparison details in Table 5):

- 200 V offset voltage covers most of the low-voltage applications, such as stepper motors, drones, battery-powered tools or inverters, etc.
- PNJ-isolated technology suitable for low-cost applications
- 3.3 V, 5 V, 15 V input logic-compatible
- Matched propagation delay time (MT)
- Better ruggedness on negative V_S tolerance up to -8 V
- Undervoltage lockout (UVLO) for both V_{CC} and V_{BS}
- Pin-pin replacement of the old parts IRS2001S/IRS2003S/IRS2004S
- -40~125 °C operating range
- RoHS-compliant

Table 5 Features' comparison of the IRS200xS family

Part	IRS2005S	IRS2007S	IRS2008S	IRS2001S	IRS2003S	IRS2004S
Input logic	HIN, LIN	HIN, $\overline{\text{LIN}}$	IN, $\overline{\text{SD}}$	HIN, LIN	HIN, $\overline{\text{LIN}}$	IN, $\overline{\text{SD}}$
V_{CC} UVLO (V)	8.9/8.2			8.9/8.2		
V_{BS} UVLO (V)	8.9/8.2			NO		
Min. V_S (V)	-8			-5		
Dead time (nS)	No	520		No	520	
Max. MT (nS)	50	50	60	50	60	60
IO+/IO- (mA)	290/600					

4.2 OptiMOS™3 IPP180N10N3 G

- N-channel, normal level
- $V_{DS}=100$ V, $I_D=43$ A
- Excellent gate charge x $R_{DS(on)}$ product (FOM)
- Very low on-resistance $R_{DS(on)}$ 18 mΩ
- RoHS-compliant and halogen-free
- Max 175 °C junction temperature

5 Getting started with the EVAL-PS-IRS200x-OM30118SB

5.1 Evaluate the driver IC on board

The static or dynamic performance of the driver ICs IRS2005S/IRS2007S/IRS2008S can be verified on the board by powering the VCC from an external auxiliary power supply and inputting the PWM signals from an external pulse generator.

The test setup is shown in Figure 4. Please consider notes below:

- There is no need to add DC BUS input if only verifying the driver IC characteristics.
- The PWM input signals and power supply share the same ground - GND.
- The high side output HO-VS is only activated if the VB-VS is powered by an extra power supply, or charged by turning on the low side MOSFET in advance.
- The VCC-COM, HIN-COM, LIN-COM, LO-COM and VS-COM can be measured by low-voltage differential probes, while the VB-VS and HO-VS should use high-voltage isolated differential probes.

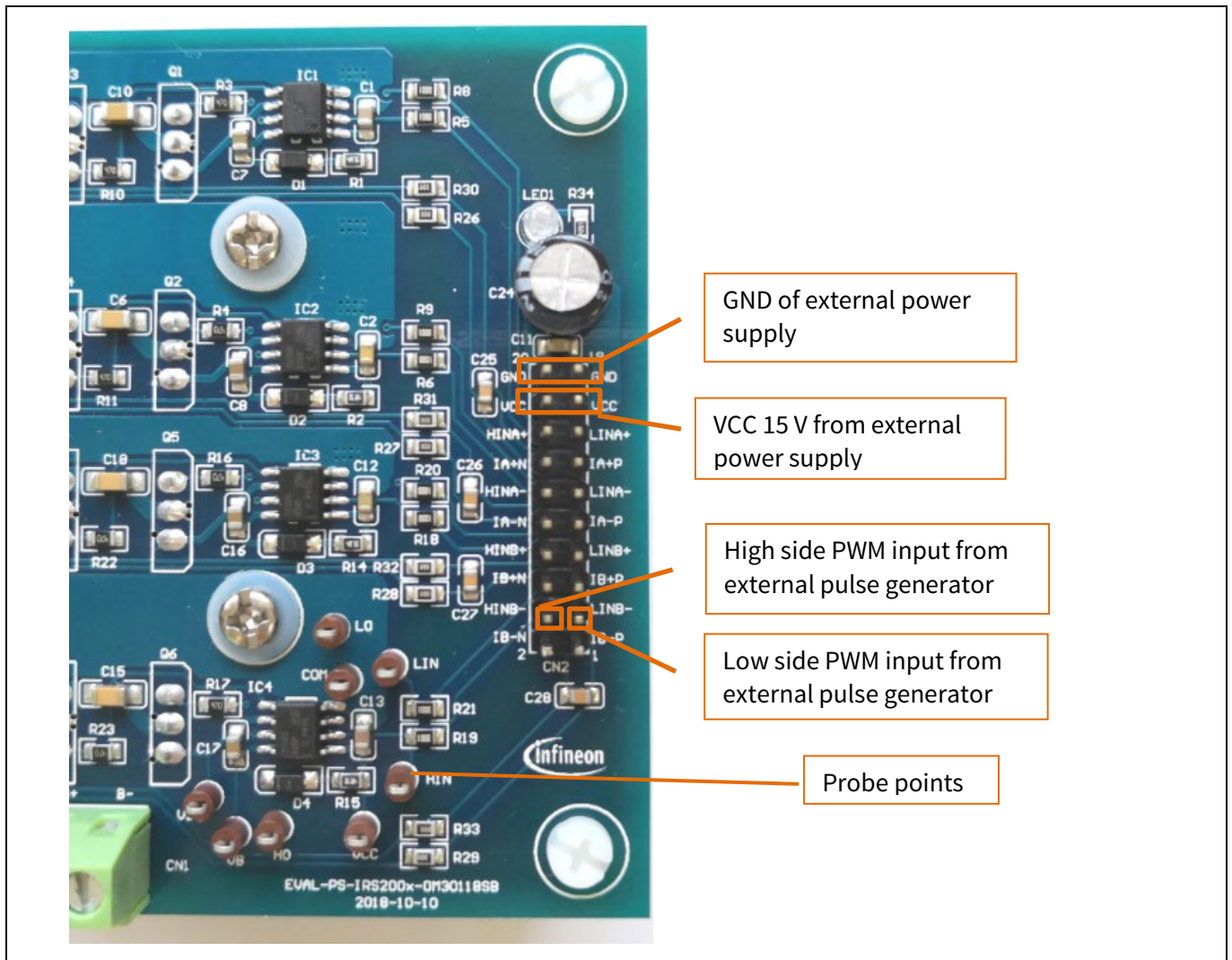

Figure 4 Evaluate the driver IC on board

Figure 5 is a typical waveform when testing the driver IC only.

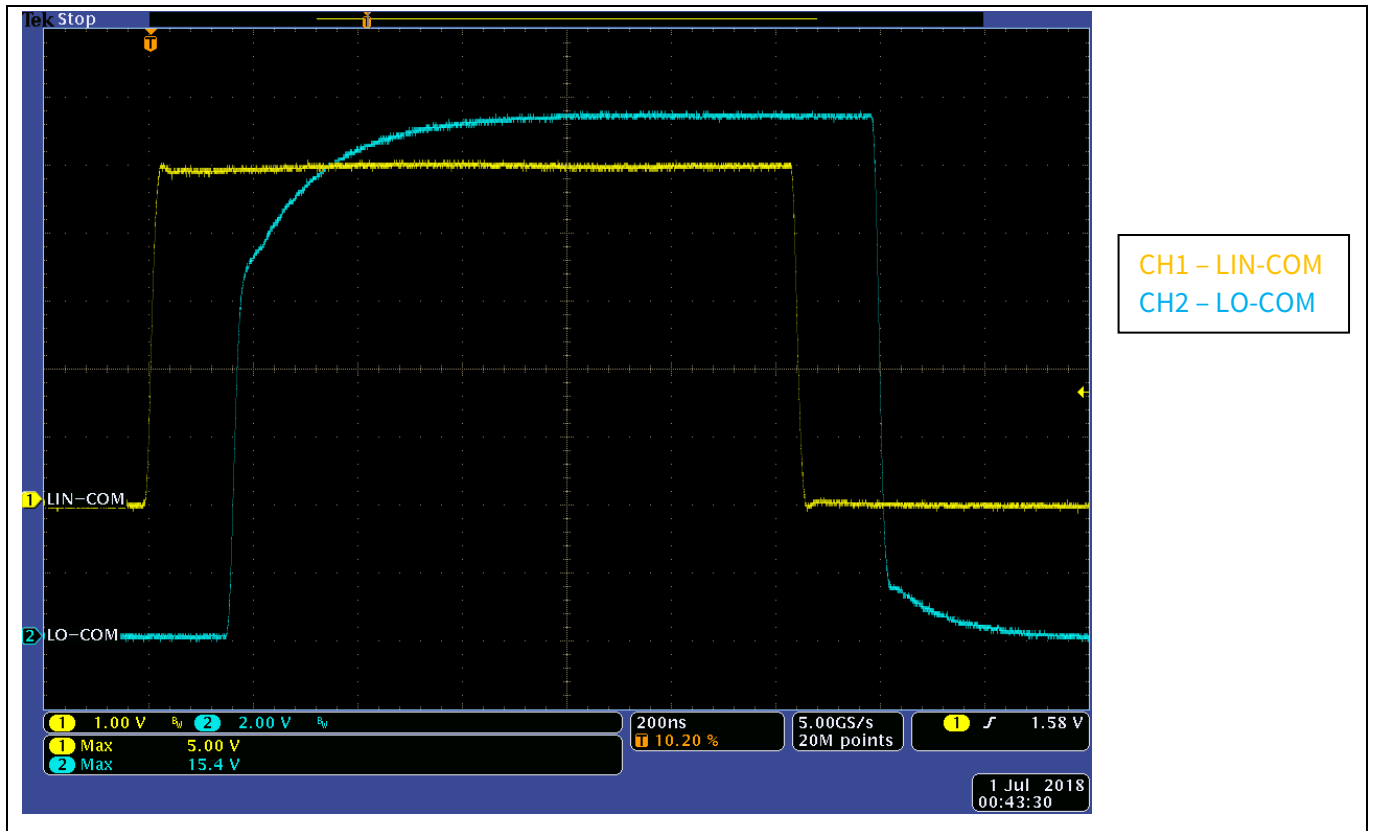

Figure 5 Typical waveform of driver IC switching performance

5.2 Running a stepper motor

By connecting to an external controller, the EVAL-PS-IRS200x-OM30118SB board can run a stepper motor.

Figure 6 shows the system connection of the power board EVAL-PS-IRS200x-OM30118SB, a stepper motor and controller interface. The gate drivers are soldered with IRS2005S in order to match the PWM logic of the external stepper motor controller used therein. The switching frequency is fixed at 20 kHz.

The board is tested at the maximum 72 V_{DC} BUS input, and up to 7 A_{RMS} phase-out current, which covers most of the power ratings in the stepper motor drives market. Only in this condition could the board be evaluated under the highest noise interference, voltage stress and thermal rise.

A low-speed and large torque stepper motor (AM34HD2403-7, made by Moons') is run in the system. From its torque-speed curve, the working condition is set at 72 V_{DC} input, 7 A_{RMS} phase-out and 0.5 r/s without load (as the stepper motor system is controlled by the phase current, and the motor can sink 7 A_{RMS} phase current without a load).

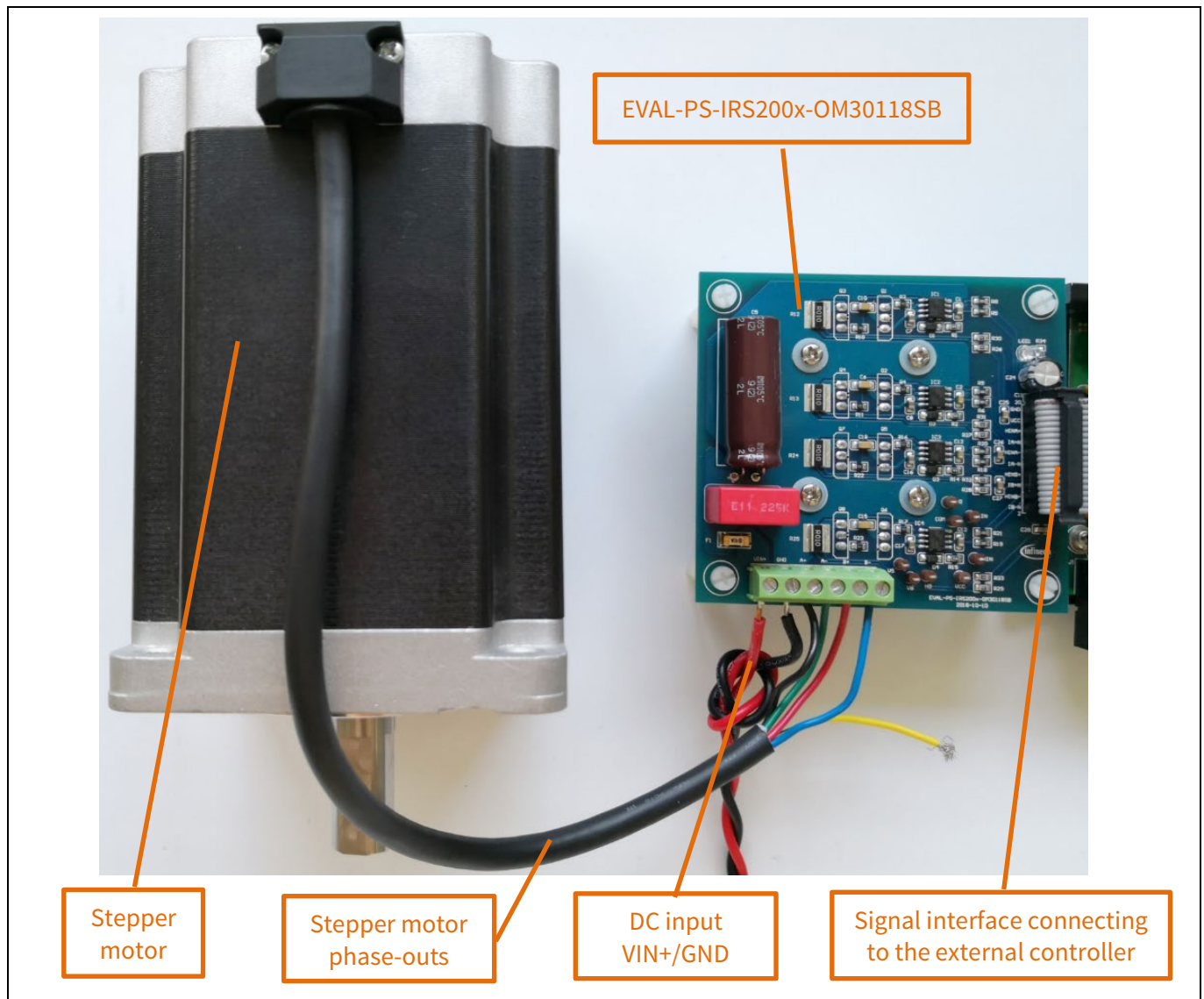

Figure 6 System configuration for running a stepper motor

Getting started with the EVAL-PS-IRS200x-OM30118SB

Before running the motor, please double check:

- The DC input voltage is at 24~72 V, otherwise the system will not start up normally, and permanent damages would be caused on the stepper motor and the power board EVAL-PS-IRS200x-OM30118SB.
- The DC source input is capable of supplying at least 3 A average current in the range of 24~72 V.
- The power supply V_{CC} to GND is in the range of 10~20 V (recommended 12 V or 15 V, voltage here is 15 V), otherwise the driver IC will not work due to undervoltage lockout; or it will be destroyed by overvoltage.
- Correct wiring before powering on the VIN+ and V_{CC} .
- Necessary cooling on the stepper motor, especially when running in the maximum current, to avoid stepper motor damage due to overheating.
- The correct selection and scaling of probes.

The typical waveforms at 7 A_{RMS} phase-out current are depicted in Figure 7 and Figure 8.

Noises can be generated at the input signal LIN/HIN-COM while V_S changes between the GND and VIN+. The noise could be effectively reduced by adding filter capacitors between the high-side MOSFET-D (VIN+) and low-side MOSFET-S. Here one SMD 470 nF/100 V ceramic capacitor is added to each phase.

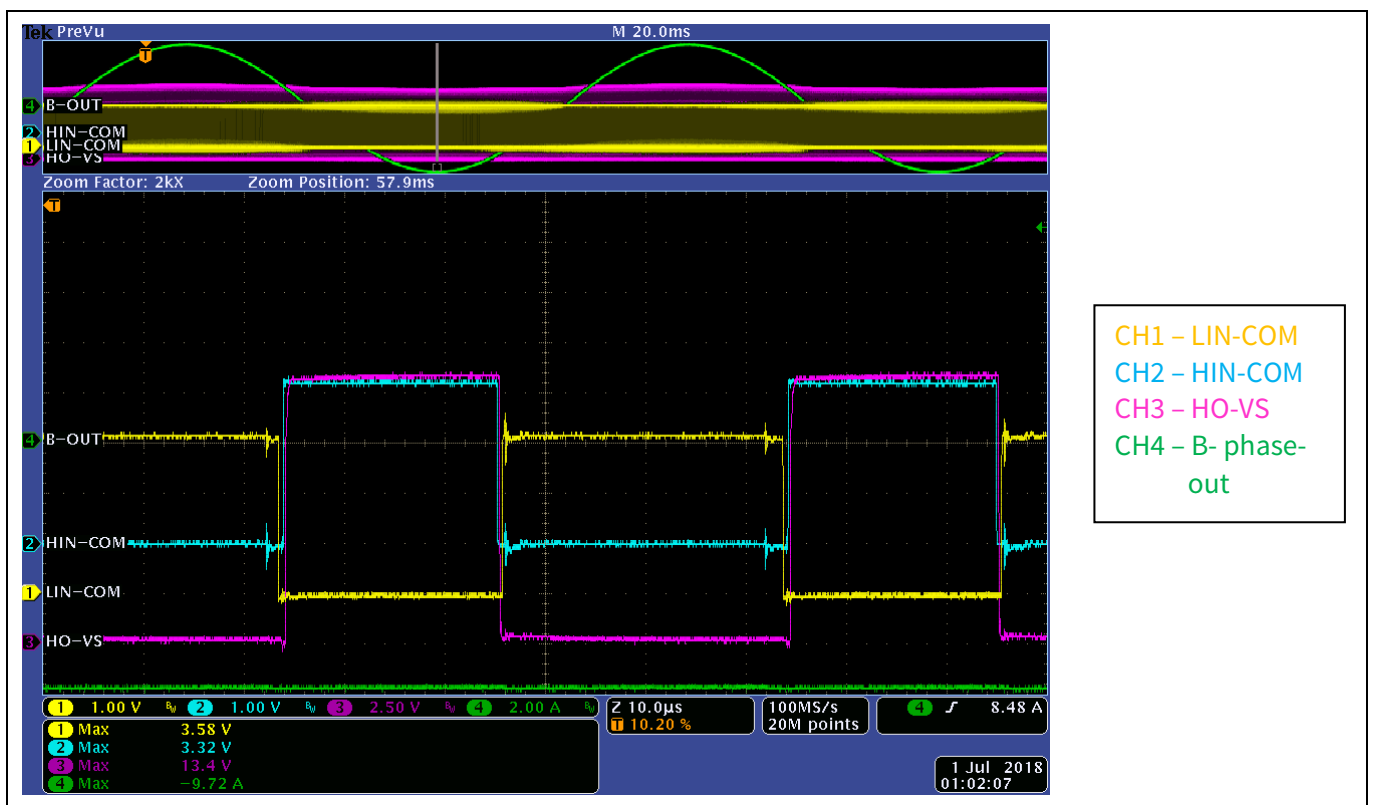

Figure 7 The input signals probed at 7 A_{RMS} phase-out current

Getting started with the EVAL-PS-IRS200x-OM30118SB

In Figure 8, the minimum V_{S-COM} of the driver IC is -5 V during normal operation. Thanks to the better immunity of negative V_s (-8 V), the new 200-V driver ICs can work under less favorable conditions.

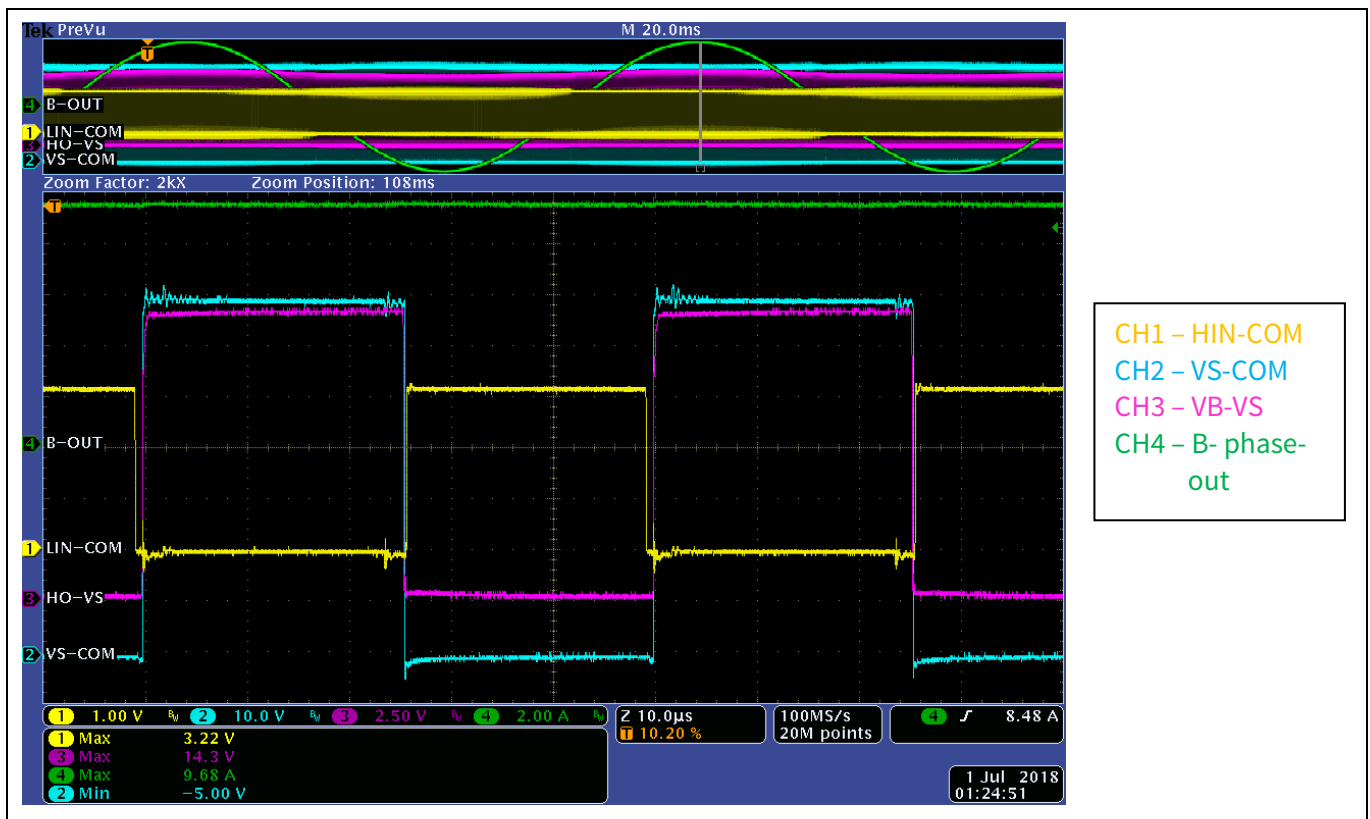

Figure 8 The V_s signal probed at 7 A_{RMS} phase-out current

6 Thermal analysis of the EVAL-PS-IRS200x-OM30118SB

The thermal performance is evaluated at 72 V_{DC} bus voltage and 7 A_{RMS} phase-out current such that all the components have the highest temperature rise. The thermal data are recorded in Figure 9 and Figure 10.

The key component temperatures are all in the normal range:

- MOSFET: The maximum case temperature is 80.4 °C in the 29 °C ambient
- Shunt resistor: the shunt resistor is rated 3 W@70 °C in the operating temperature range of -55~155 °C. The maximum shunt temperature is 72 °C in the 29.9 °C ambient.
- Gate driver IC: The maximum junction temperature is 150°C. The gate driver IC power loss consists of two major parts, the internal level-shift switching loss and the driving loss. In the fixed switching frequency of 20 kHz, the calculated gate driver IC total power loss is very small (<0.1 W), therefore the junction temperature should be close to the case temperature, which is measured at 68.9 °C in the 29.9 °C ambient.

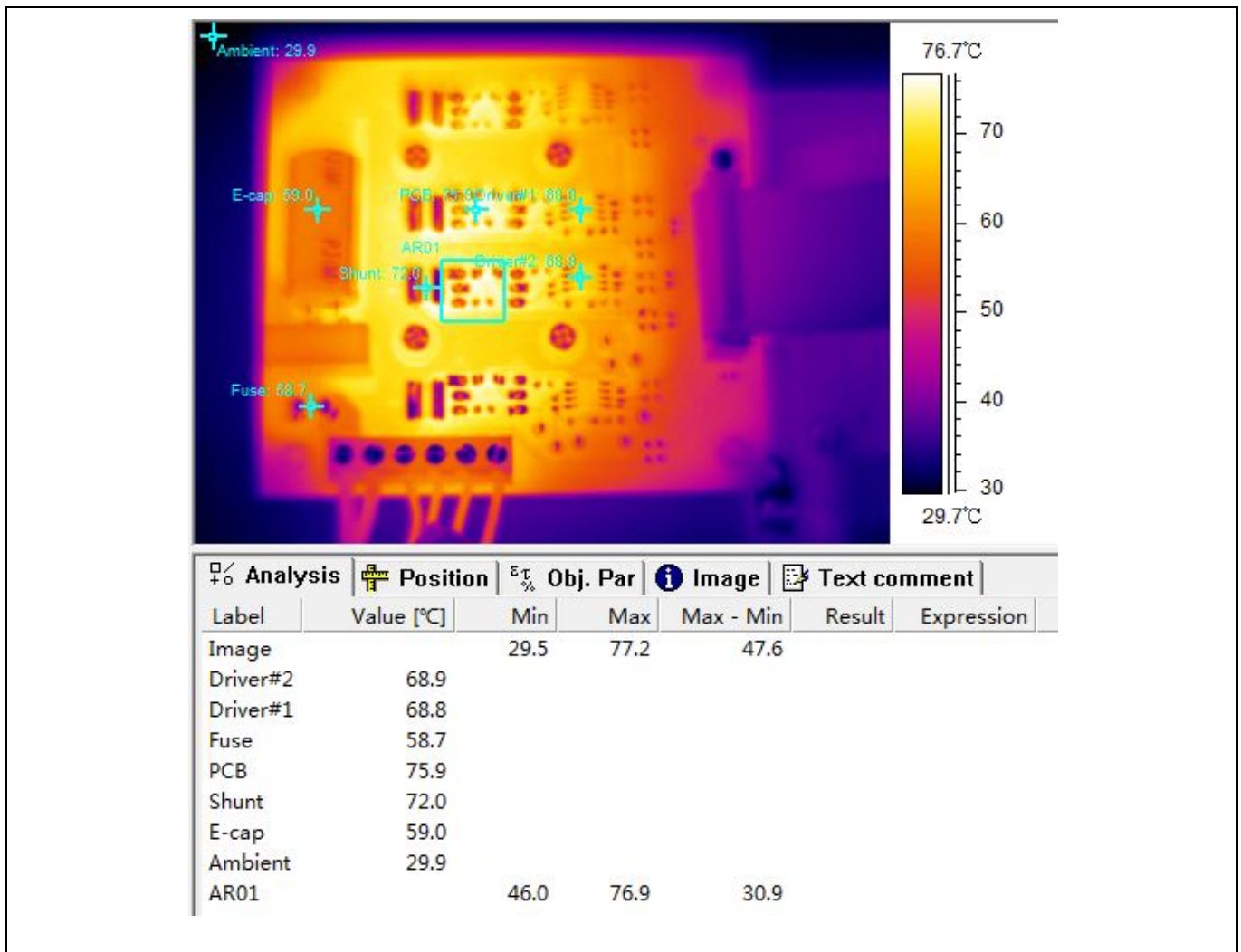

Figure 9 Thermal breakdown at 72 V_{DC} input and 7 A_{RMS} phase current

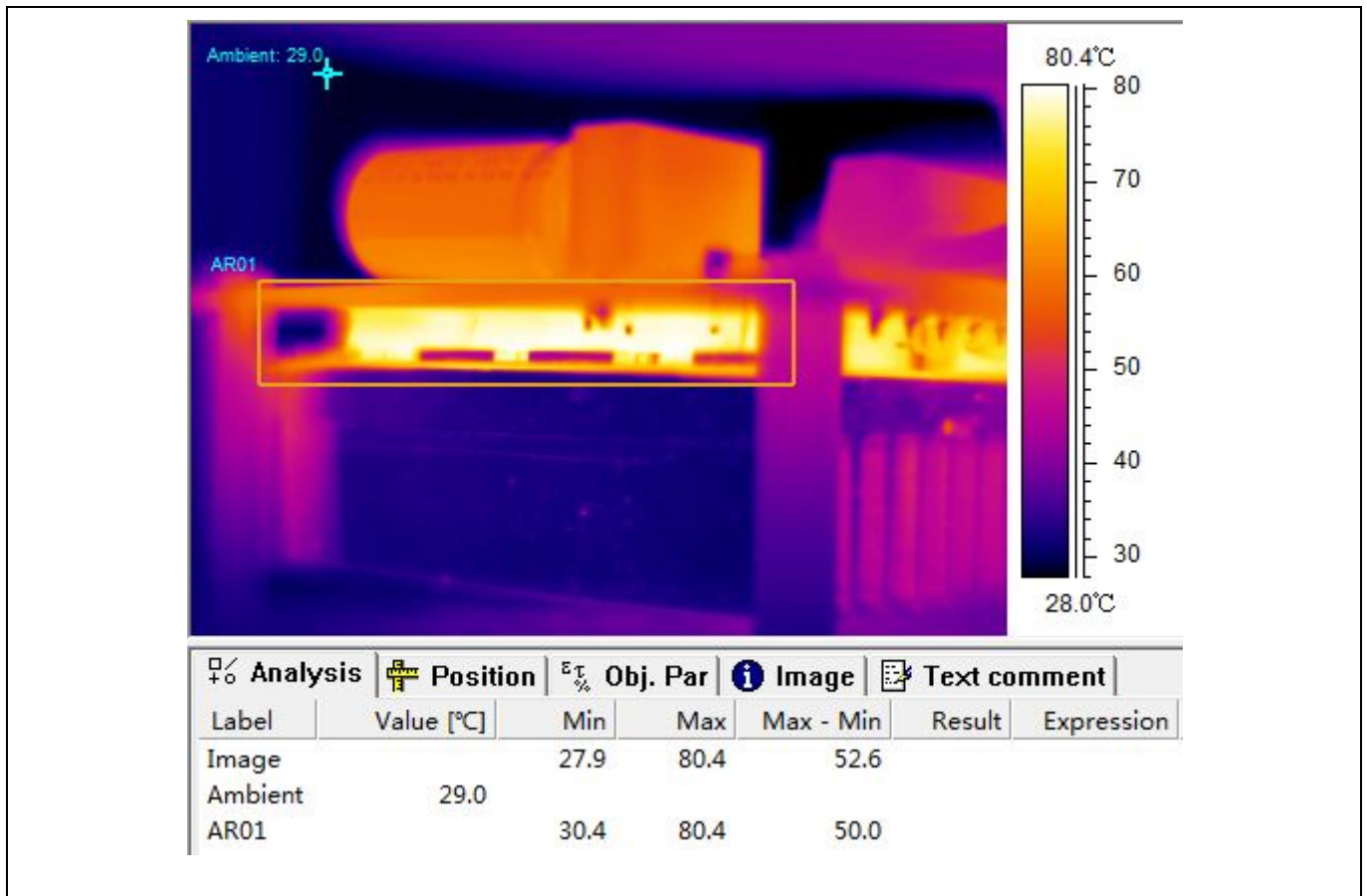

Figure 10 MOSFET temperature rise at 72 V_{DC} input and 7 A_{RMS} phase current

7.2 PCB layout

The layout details of the EVAL-PS-IRS200x-OM30118SB are illustrated in Figure 12, 13, 14 and 15.

Some layout tips are indicated on this board:

- The power conductor paths such as VIN, GND, phase-out, etc. should be as thick as possible for a lower temperature rise and lower parasitic inductances.
- The shunt resistor parasitic inductance should be as low as possible for a smaller negative V_s .
- The link conductor path of the high-side MOSFET-S and low-side MOSFET-D should be as thick and short as possible for a smaller parasitic inductance.
- The power ground and controller ground should be individually copper-filled (in the production process) and then shorted at the individual driver IC-COM pin. In this way the LO-COM drive loop parasitic inductance and the HIN/LIN-COM input signal loop parasitic inductance are both as small as possible (see Figure 13 and Figure 15).
- The V_{CC} and V_{BS} bypass capacitors should be close to the IC.
- Current sensing should be connected directly at the shunt-resistor terminals and sent to the controller interface as a differential pair.
- The filter caps C10, C6, C18, and C15 are essential for suppressing the noise interference between the phases conducted from ground line, and for minimizing the negative V_s .

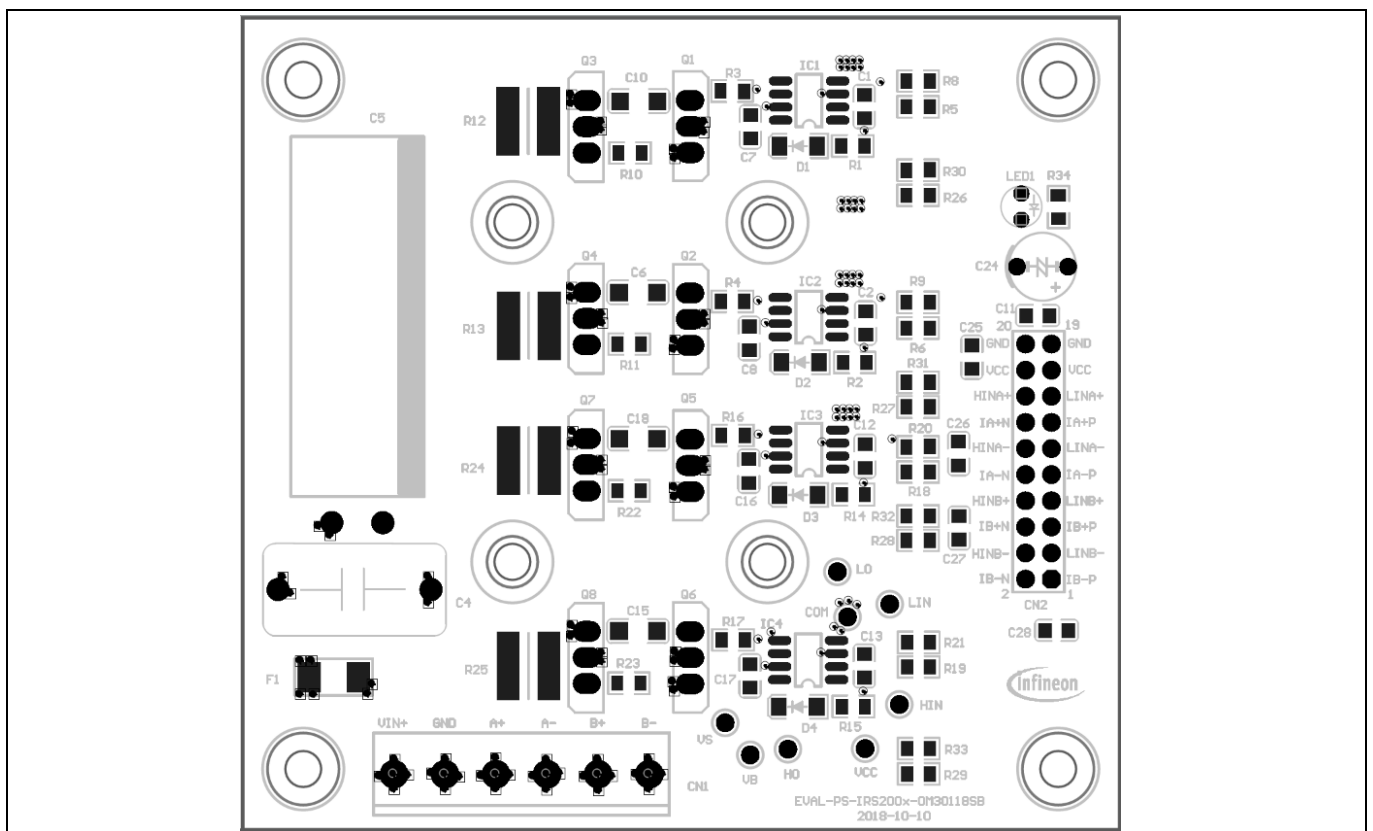

Figure 12 Top assembly drawing of the EVAL-PS-IRS200x-OM30118SB

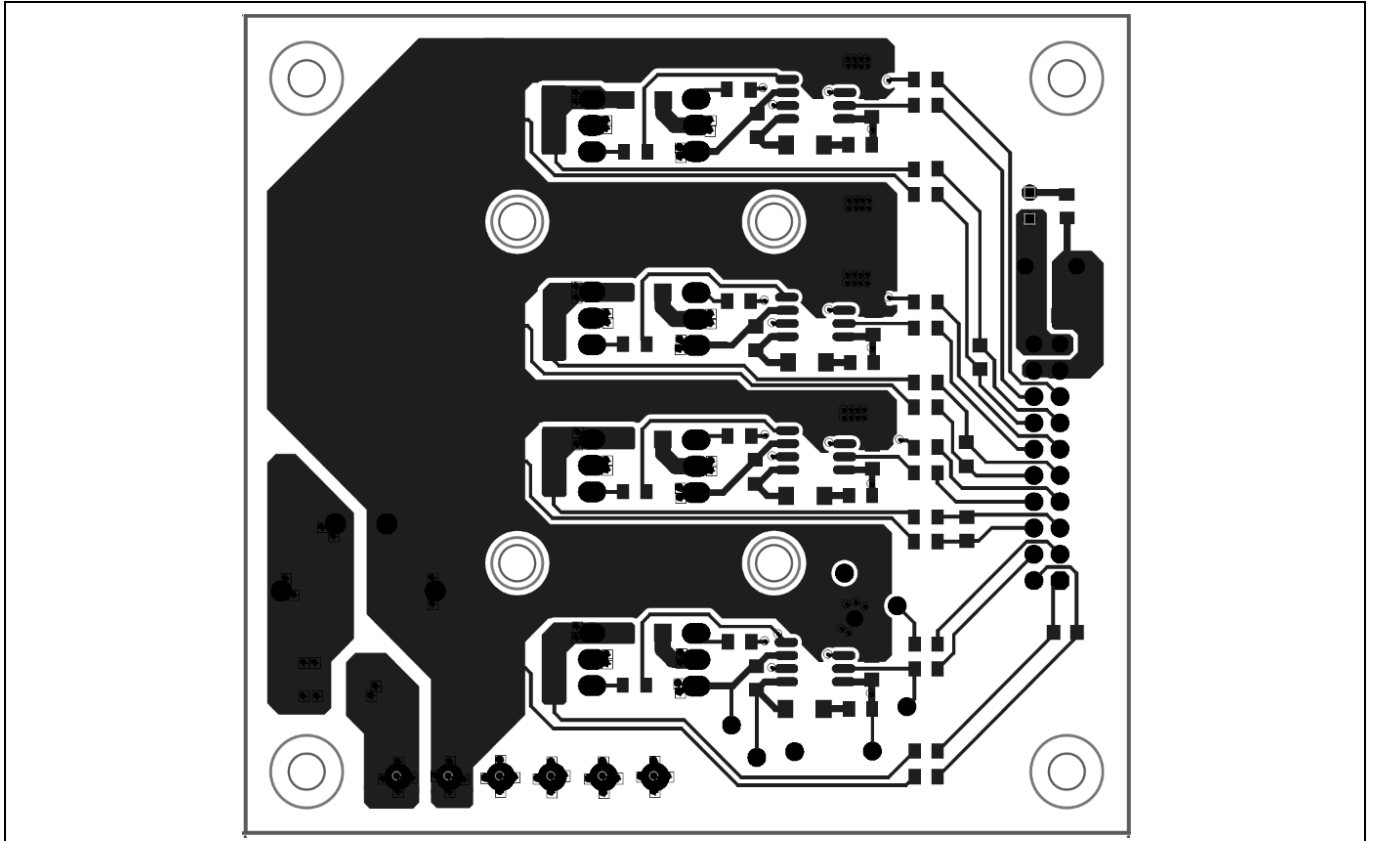

Figure 13 Top layer routing of the EVAL-PS-IRS200x-OM30118SB

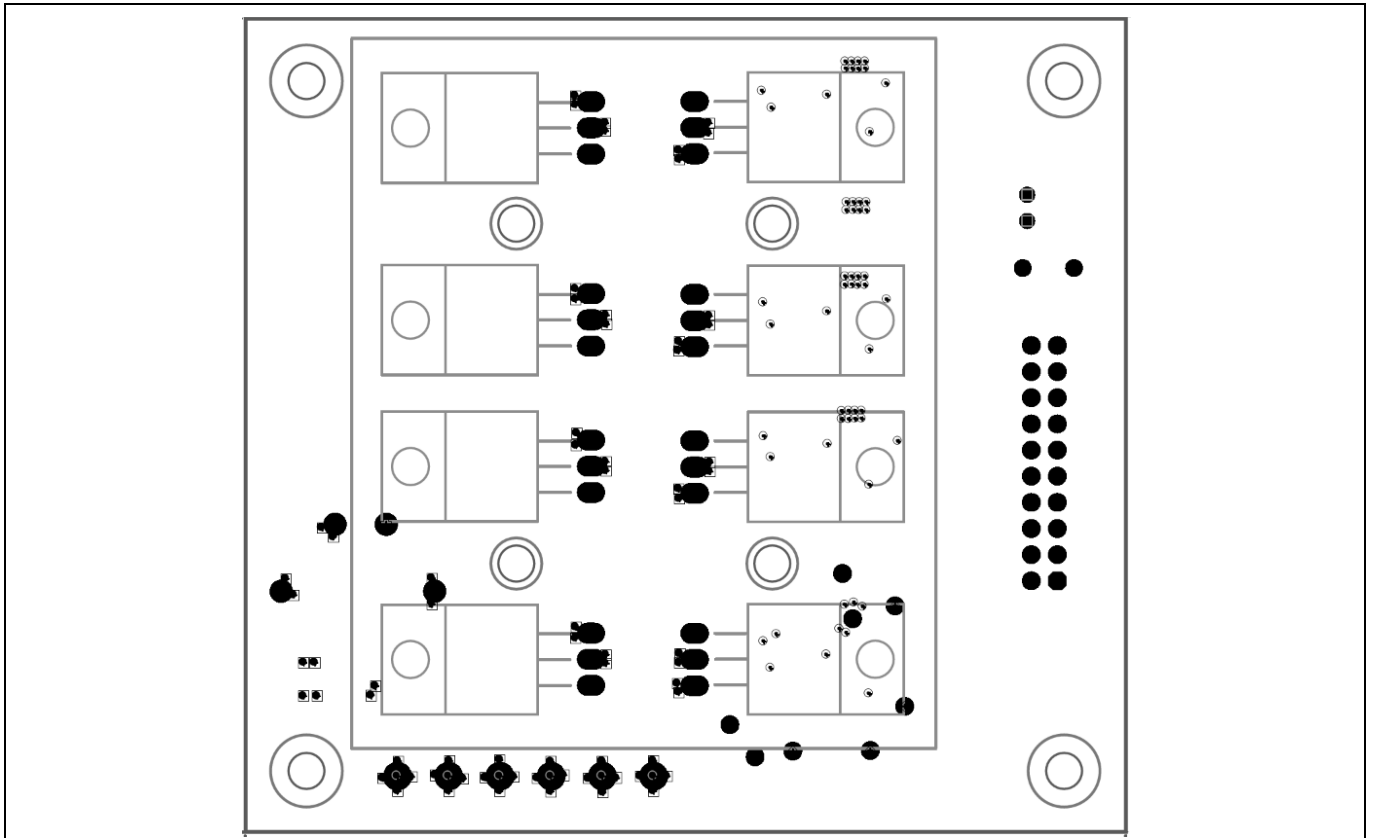

Figure 14 Bottom assembly drawing of the EVAL-PS-IRS200x-OM30118SB

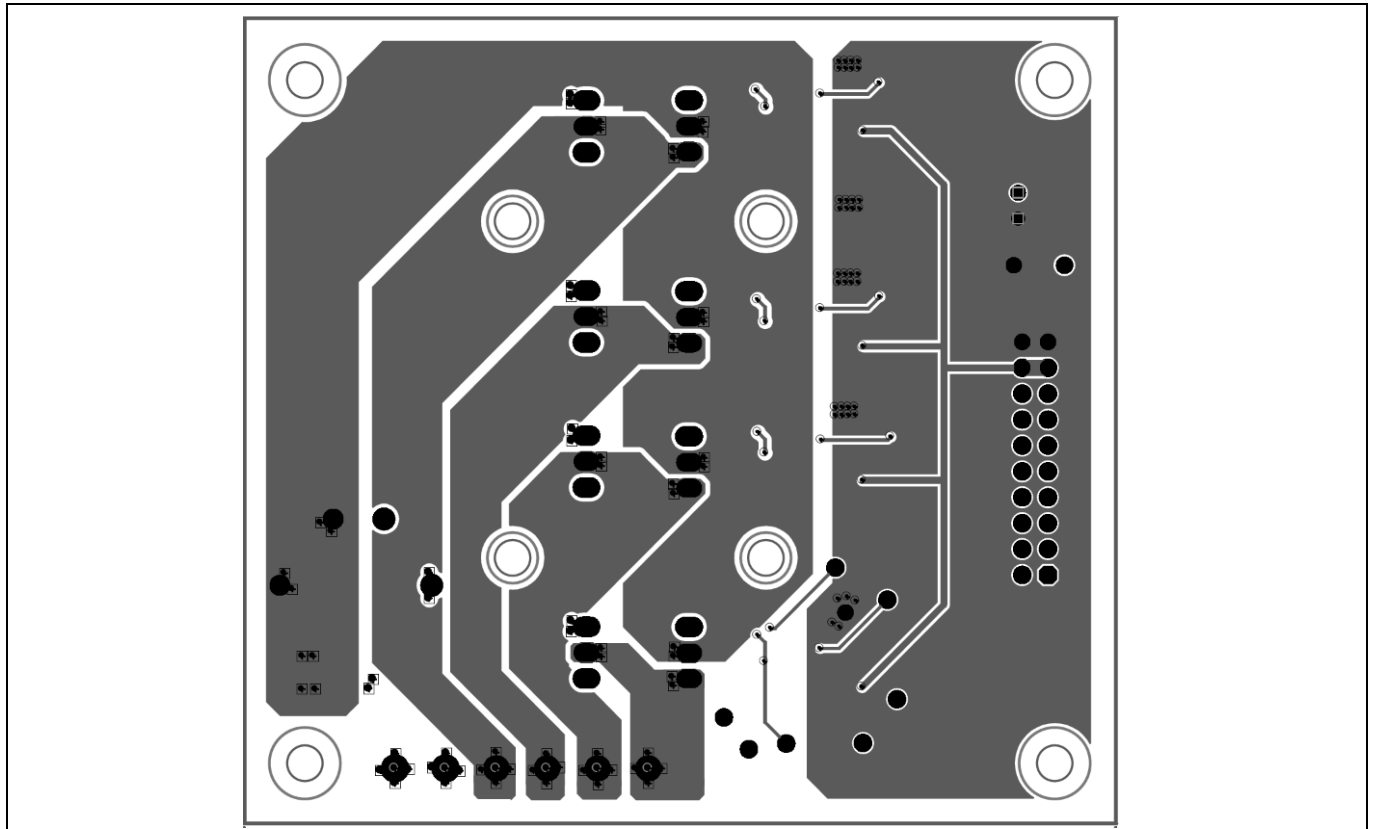

Figure 15 Bottom layer routing of the EVAL-PS-IRS200x-OM30118SB

Bill of material

8 Bill of material

All the components of the EVAL-PS-IRS200x-OM30118SB board are summarized in Table 6.

Table 6 Bill of materials

No.	Qty	Part description	Designator	Part number	Manufacturer
1	5	CAP CER 10 μ F 25V X5R 0805	C1, C2, C11, C12, C13	C2012X5R1E106M125 AB	TDK Corporation
2	1	CAP ALUM 330 μ F 100V RADIAL	C5	UHW2A391MHD12.5x3 5.5	Rubycon Corporation
3	4	CAP CER 470nF 100V X5R 1206	C6, C10, C15, C18	C3216X5R1E226M160 AB	TDK Corporation
4	4	CAP CER 1 μ F 25V X5R 0805	C7, C8, C16, C17	C2012X5R1E106M125 AB	TDK Corporation
5	1	CAP ALUM 100 μ F 25V RADIAL	C24	UPJ1E101MED6.3x15	Rubycon Corporation
6	4	CAP CER 100pF 25V X5R 0805	C25, C26, C27, C28	C2012X5R1E106M125 AB	TDK Corporation
7	4	FAST SWITCHING DIODE 200V 0.4A SOD123	D1, D2, D3, D4	BAV21W	DIODES
8	1	VERY FAST-ACTING FUSE 10A 125DC	F1	0451010.MRL	Little Fuse
9	4	200V PNJ Gate Driver	IC1, IC2, IC3, IC4	IRS2005S/IRS2007S/IRS2008S	Infineon Technologies
10	8	OptiMOS™3 100V 18m Ω N-MOSFET	Q1, Q2, Q3, Q4, Q5, Q6, Q7, Q8	IPP180N10N3 G	Infineon Technologies
11	1	LED GREEN CLEAR 3MM	LED1	151033GS03000	Würth Electronics Inc.
12	4	RES SMD 4.7 Ω 1% 1/8W0805	R1, R2, R14, R15	RC0805FR-071ML	Yageo
13	8	RES SMD 47 Ω 1% 1/8W0805	R3, R4, R10, R11, R16, R17, R22, R23	RC0805FR-071ML	Yageo
14	8	RES SMD 100 Ω 1% 1/8W0805	R5, R6, R8, R9, R18, R19, R20, R21	RC0805FR-071ML	Yageo
15	8	RES SMD 0 Ω 1% 1/8W0805	R26, R27, R28, R29, R30, R31, R32, R33	RC0805FR-071ML	Yageo
16	1	RES SMD 4.7k Ω 1% 1/8W0805	R34	RC0805FR-071ML	Yageo
17	4	RES SMD 10m Ω 1% 3W 1225	R12, R13, R24, R25	CS25FTETR010	Viking Tech
18	1	CAP FILM 2.2 μ F 10% 100VDC RADIAL	C4	890263425004CS	Würth Electronics Inc.

Bill of material

No.	Qty	Part description	Designator	Part number	Manufacturer
19	1	SERIE 2365 – 5.08 MM HORIZONTAL CABLE ENTRY MODULAR WITH RISING CAGE CLAMP WR-TBL	CN1	691236510003	Würth Electronics Inc.
20	1	2.54 MM DUAL PIN HEADER	CN2	61302021121	Würth Electronics Inc.
21	8	TEST POINT MINIATURE	COM, HIN, HO, LIN, LO, VB, VCC, VS	5002	Keystone Electronics
22	4	Screw		M3*14	
23	4	Screw plastic washer		M3*8	
24	1	Sil-pad		SP900S, 0.23 mm, 60*70 mm	

Reference

9 Reference

- [1] Datasheet of Infineon Technologies IRS2005S
- [2] Datasheet of Infineon Technologies IRS2007S
- [3] Datasheet of Infineon Technologies IRS2008S
- [4] Application Note AN-978 – HV Floating MOS-Gate Driver ICs
- [5] User Manual of MOONS' Host Command Reference, Rev.J, 12/2014
- [6] User Manual of MOONS' Stepper motor Driver Hardware Brochure MSSTB10-R, V1.0, 11/20/2015

Note: All listed driver datasheets and application notes are available for downloading from Infineon's website www.infineon.com/.

All listed references of MOONS' product are available for downloading from MOONS' website <http://www.moons.com.cn/>

Revision history

Revision history

Document version	Date of release	Description of changes
1.0	2018-12-19	First release

Trademarks

All referenced product or service names and trademarks are the property of their respective owners.

Edition 2018-12-19

Published by

Infineon Technologies AG

81726 Munich, Germany

© 2019 Infineon Technologies AG.

All Rights Reserved.

Do you have a question about this document?

Email: erratum@infineon.com

Document reference

AN2018-30

IMPORTANT NOTICE

The information contained in this application note is given as a hint for the implementation of the product only and shall in no event be regarded as a description or warranty of a certain functionality, condition or quality of the product. Before implementation of the product, the recipient of this application note must verify any function and other technical information given herein in the real application. Infineon Technologies hereby disclaims any and all warranties and liabilities of any kind (including without limitation warranties of non-infringement of intellectual property rights of any third party) with respect to any and all information given in this application note.

The data contained in this document is exclusively intended for technically trained staff. It is the responsibility of customer's technical departments to evaluate the suitability of the product for the intended application and the completeness of the product information given in this document with respect to such application.

For further information on the product, technology delivery terms and conditions and prices please contact your nearest Infineon Technologies office (www.infineon.com).

WARNINGS

Due to technical requirements products may contain dangerous substances. For information on the types in question please contact your nearest Infineon Technologies office.

Except as otherwise explicitly approved by Infineon Technologies in a written document signed by authorized representatives of Infineon Technologies, Infineon Technologies' products may not be used in any applications where a failure of the product or any consequences of the use thereof can reasonably be expected to result in personal injury.

Mouser Electronics

Authorized Distributor

Click to View Pricing, Inventory, Delivery & Lifecycle Information:

[Infineon:](#)

[EVALPSIRS200XTOBO1](#)