

LTM4630EV

High Efficiency, PolyPhase

105A Step-Down Power

μModule Regulator

DESCRIPTION

Demonstration circuit 2007A-B features a PolyPhase® design using the LTM®4630EV, the high efficiency, high density, dual 18A, switch mode step-down power μModule® regulator. The input voltage is from 4.5V to 15V. The output voltage is jumper selectable from 0.9V to 1.8V. The DC2007A-B can deliver a nominal 105A output current. As explained in the data sheet, output current derating is necessary for certain V_{IN} , V_{OUT} , and thermal conditions. The LTM4630 on DC2007A-B always operates in continuous conduction mode. The switching frequency can be programmed through a resistor or can be synchronized to an external clock signal. The board allows the user to program how its output voltage ramps up and down through the

TRACK pin. The output voltage is tightly regulated between “VO+” and “VO-” through remote output voltage sensing which improves output voltage regulation at heavy loads. These features and the availability of the LTM4630EV in a compact 16mm × 16mm × 4.41mm LGA package make it ideal for use in many high density point-of-load regulation applications. The LTM4630 data sheet must be read in conjunction with this demo manual for working on or modifying the demo circuit DC2007A-B.

Design files for this circuit board are available at <http://www.linear.com/demo>

LT, LT, LTC, LTM, Linear Technology, the Linear logo, PolyPhase and μModule are registered trademarks of Linear Technology Corporation. All other trademarks are the property of their respective owners.

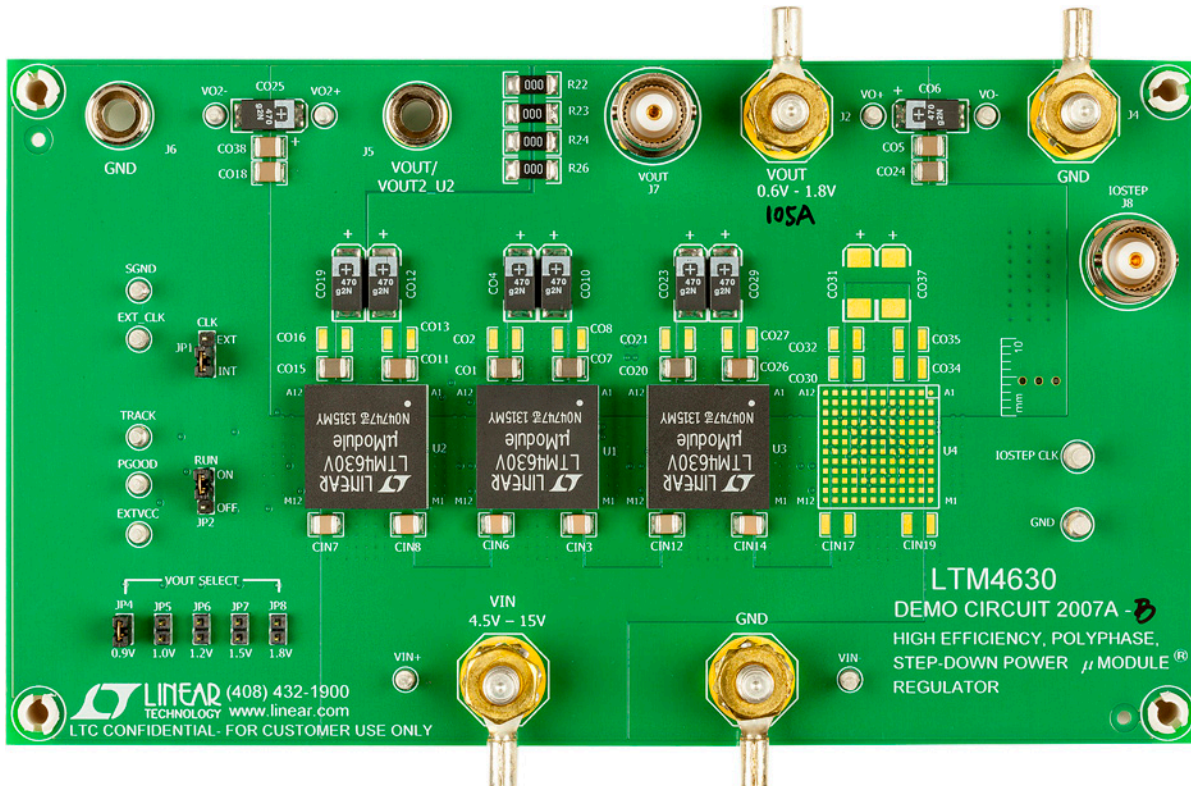

Figure 1. 70A PolyPhase LTM4630/DC2007A-B Demo Board

DEMO MANUAL DC2007A-B

PERFORMANCE SUMMARY Specifications are at $T_A = 25^\circ\text{C}$

PARAMETER	CONDITIONS / NOTES	VALUE
Input Voltage Range		4.5V ~ 15V
Output Voltage V_{OUT}	$V_{IN} = 4.5A \sim 15V, I_{OUT} = 0A \sim 105A, JP5: 1.0V$	$1.0V \pm 1.5\%$ (0.985V ~ 1.015V)
Maximum Continuous Output Current	Derating Is Necessary for Certain V_{IN}, V_{OUT} and Thermal Conditions, See Data Sheet for Details.	105A
Default Operating Frequency		400kHz
Resistor Programmable Frequency Range		400kHz to 780kHz
External Clock Sync. Frequency Range		400kHz to 780kHz
Efficiency	$V_{IN} = 12V, V_{OUT} = 1.0V, I_{OUT} = 105A, f_{SW} = 400kHz$	83.8% See Figure 3
Load Transient	$V_{IN} = 12V, V_{OUT} = 1.0V, I_{STEP} = 0A \sim 26.25A$	<100mV, See Figure 4
Output Voltage Ripple	$V_{IN} = 12V, V_{OUT} = 1.0V, I_{OUT} = 105A$	<4mV, See Figure 5

QUICK START PROCEDURE

Demonstration circuit DC2007A-B is easy to set up to evaluate the performance of PolyPhase operation of the LTM4630EV. Due to the high input/output current, user should select the proper input supply/load/cable which can sustain the full load operation. It's recommended to pull load current from J2 and J4. The load current pulled from J5 and J6 shouldn't exceed 18A. Please refer to Figure 2 for proper measurement setup and follow the procedure below:

1. Place jumpers in the following positions for a typical 1.0V_{OUT} application:

<i>JP1</i>	<i>JP2</i>	<i>JP4 ~ JP8</i>
CLK	RUN	VOUT SELECT
INT	OFF	ON JP5/1.0V

2. With power off, connect the input power supply, load and meters as shown in Figure 2. Preset the load to 0A and V_{IN} supply to 12V.
3. Turn on the power supply at the input. Place JP2 to the ON position. The output voltage between "VO+" and "VO-" should be $1.0V \pm 1.5\%$ (0.985V ~ 1.015V).
4. Once the proper output voltage is established, adjust the load within the operating range and observe the output voltage regulation, output voltage ripple, efficiency and other parameters. Output voltage ripple should be measured at J7 with BNC cables. 50 Ω termination should be set on the oscilloscope or BNC cables.

5. (Optional) For an optional load transient test, apply an adjustable pulse signal between "IOSTEP CLK" and the "GND" test point. Pulse amplitude (3V ~ 3.5V) sets the load step current amplitude. The output transient current can be monitored at the BNC connector, J8 (5mV/A). The pulse signal should be very small duty cycle (<10%) to limit the thermal stress on the transient load circuit.
6. (Optional) The LTM4630 can be synchronized to an external clock signal. Place the JP1 jumper on EXT and apply a clock signal (0V ~ 5V, square wave) on the "EXT_CLK" test point.
7. (Optional) The outputs of the LTM4630 can track another supply. The output voltage tracks the voltage on TRACK when a valid signal is applied on the test point.
8. (Optional) The DC2007A-B can be configured to a dual output configuration with VO at 87.5A load current and VO2 at 18A load current. Stuff a 0 Ω resistor on R61 and a 0.1 μ F on C14. Remove R22, R23, R24, R26, R27, R28, R32, R33, R35. Output voltage VO2 is set by R37 based on the equation $VO2 = 0.6V(1 + 60.4K/R37)$.

QUICK START PROCEDURE

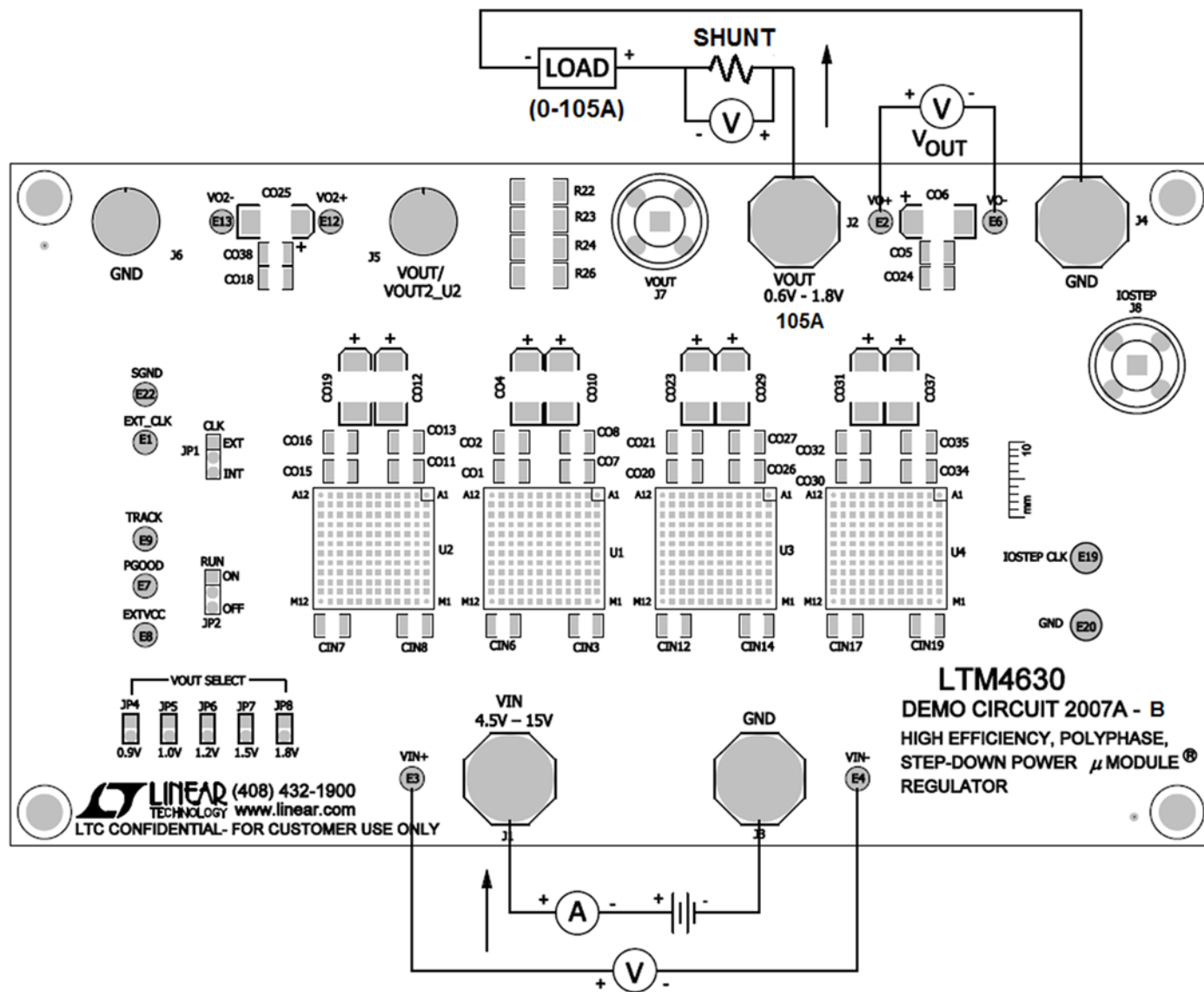

Figure 2. Test Setup of DC2007A-B

QUICK START PROCEDURE

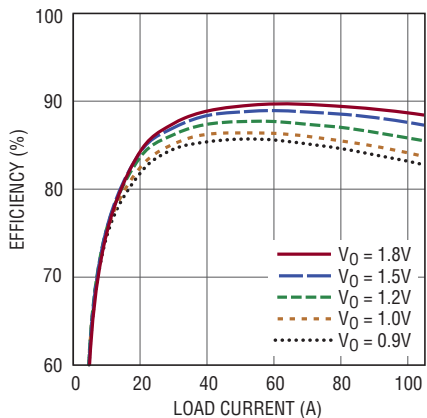

Figure 3. Measured Efficiency $V_{IN} = 12V$, $f_{SW} = 400kHz$

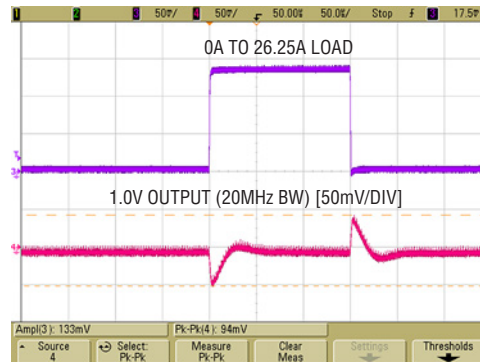

Figure 4. Load Transient 0A to 26.25A ($V_{IN} = 12V$, $V_{OUT} = 1.0V$)

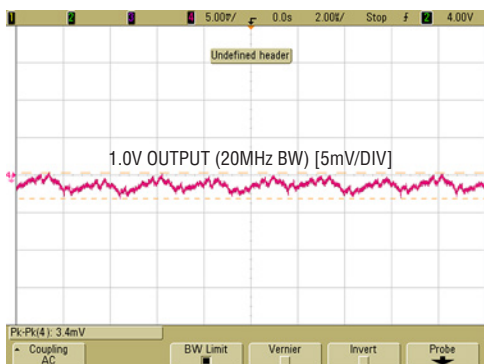

Figure 5. Measured Output Voltage Ripple at $12V_{IN}$, $1.0V_{OUT}$, $105A$ with Standard Demo Circuit Default Setup

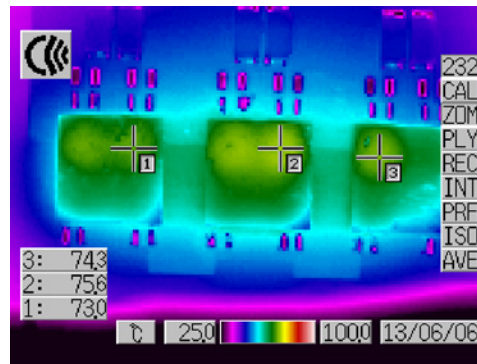

Figure 6. Thermal Capture at $12V_{IN}$, $1.0V_{OUT}$, $105A$ ($T_A = 25^\circ C$, 400 LFM Airflow and No Heat Sink)

PARTS LIST

ITEM	QTY	REFERENCE	PART DESCRIPTION	MANUFACTURER/PART NUMBER
Required Circuit Components				
1	12	CIN3, CIN4, CIN5, CIN6, CIN7, CIN8, CIN9, CIN10, CIN12, CIN13, CIN14, CIN15	CAP, 1210 22 μ F 10% 25V X5R	AVX, 12103D226KAT2A
2	10	C01, C05, C07, C011, C015, C018, C020, C024, C026, C038	CAP, 1210 100 μ F 20% 10V X5R	TAIYO YUDEN, LMK325BJ107MM-T
3	8	C04, C06, C010, C012, C019, C023, C025, C029	CAP, 7343 470 μ F 20% 4V POSCAP	SANYO, 4TPE470MCL
4	15	R6, R13, R19, R20, R27, R28, R32, R33, R34, R35, R40, R45, R46, R62, R63	RES, 0603 0 Ω JUMPER	VISHAY, CRCW06030000Z0EA
5	3	U1, U2, U3	IC, VOLTAGE REGULATOR, LGA	LINEAR TECH., LTM4630EV#PBF
Additional Demo Board Circuit Components				
1	1	CIN1	CAP, 150 μ F 25% 25V ALUM	SUN ELECT., 25CE150AX
2	2	CIN2, CIN11	CAP, 1206 1 μ F 10% 25V X5R	TAIYO YUDEN, TMK316BJ105KD-T

PARTS LIST

ITEM	QTY	REFERENCE	PART DESCRIPTION	MANUFACTURER/PART NUMBER
3	1	C1	CAP, 0603 100pF 10% 25V XNPO	AVX, 06033A101KAT2A
4	0	C2, C3, C5, C8, C9, C12, C13, C14, C15, C16, C17, C20, C21, C26, C29, C30	CAP, 0603 OPTION	OPTION
5	4	C4, C10, C18, C22	CAP, 0603 2.2μF 20% 10V X5R	TAIYO YUDEN, LMK107BJ225MA-T
6	6	C6, C11, C19, C23, C27, C28	CAP, 0603 1μF 10% 10V X7R	TAIYO YUDEN, LMK107BJ105KA-T
7	2	C7, C25	CAP, 0603 0.1μF 10% 25V X7R	AVX, 06033C104KAT2A
8	1	C24	CAP, 0603 0.01μF 10% 100V X7R	AVX, 06031C103KAT2A
9	0	C02, C03, C08, C09, C013, C014, C016, C017, C021, C022, C027, C028, C030, C032, C033, C034, C035, C036	CAP, 1210 OPTION	OPTION
10	0	C031, C037	CAP, 7343 OPTION	OPTION
11	0	CIN16, CIN17, CIN18, CIN19	CAP, 1210 OPTION	OPTION
12	2	Q1, Q2	MOSFET, N-CH D-S 30V T0252	VISHAY, SUD50N04-8M8P-4GE3
13	4	R1, R3, R25, R29	RES, 0603 10Ω 5% 1/10W	VISHAY, CRCW060310R0JNEA
14	5	R2, R14, R21, R39, R47	RES, 0603 121k 1% 1/10W	VISHAY, CRCW0603121KFKEA
15	4	R4, R36, R41, R54	RES, 0603 10k 5% 1/10W	VISHAY, CRCW060310K0JNEA
16	0	R5, R7, R8, R10, R30, R37, R38, R42, R44, R48, R49, R50, R52, R53, R55, R61	RES, 0603 OPTION	OPTION
17	4	R9, R31, R43, R51	RES, 0603 100k 1% 1/10W	VISHAY, CRCW0603100KFKEA
18	1	R15	RES, 0603 90.9k 1% 1/10W	VISHAY, CRCW060390K9FKEA
19	1	R16	RES, 0603 60.4k 1% 1/10W	VISHAY, CRCW060360K4FKEA
20	1	R17	RES, 0603 40.2k 1% 1/10W	VISHAY, CRCW060340K2FKEA
21	1	R18	RES, 0603 30.1k 1% 1/10W	VISHAY, CRCW060330K1FKEA
22	4	R22, R23, R24, R26	RES, 2010 0Ω JUMPER	VISHAY, CRCW20100000Z0EF
23	2	R56, R57	RES, 2512 0.010Ω 1% 1W	VISHAY, WSL2512R01000FEA
24	0	R58, R59	RES, 2512 OPTION	OPTION
25	1	R60	RES, 1206 0Ω JUMPER	VISHAY, CRCW12060000Z0EA
26	0	U4		OPTION
Hardware				
1	11	E1, E2, E3, E4, E6, E7, E8, E9, E12, E13, E22	TURRET	MILL MAX 2308-2-00-80-00-00-07-0
2	2	E19, E20	TURRET	MILL MAX 2501-2-00-80-00-00-07-0
3	2	JP1, JP2	HEADER, 3-PIN 2mm	SAMTEC TMM-103-02-L-S
4	5	JP4, JP5, JP6, JP7, JP8	HEADER, 2-PIN 2mm	SAMTEC TMM-102-02-L-S
5	4	J1, J2, J3, J4	STUD	PEM KFH-032-10
6	2	J5, J6	JACK, BANANA	KEYSTONE 575-4
7	8		NUT, BRASS 10-32	ANY
8	4		LUG RING #10	KEYSTONE 8205
9	4		WASHER, TIN PLATED BRASS #10	ANY
10	2	J7, J8	CON, BNC	CONNEX 112404
11	3	JP1, JP2, JP4	SHUNT	SAMTEC 2SN-BK-G
12	4		STAND-OFF, NYLON	KEYSTONE 8833

DEMO MANUAL DC2007A-B

SCHEMATIC DIAGRAM

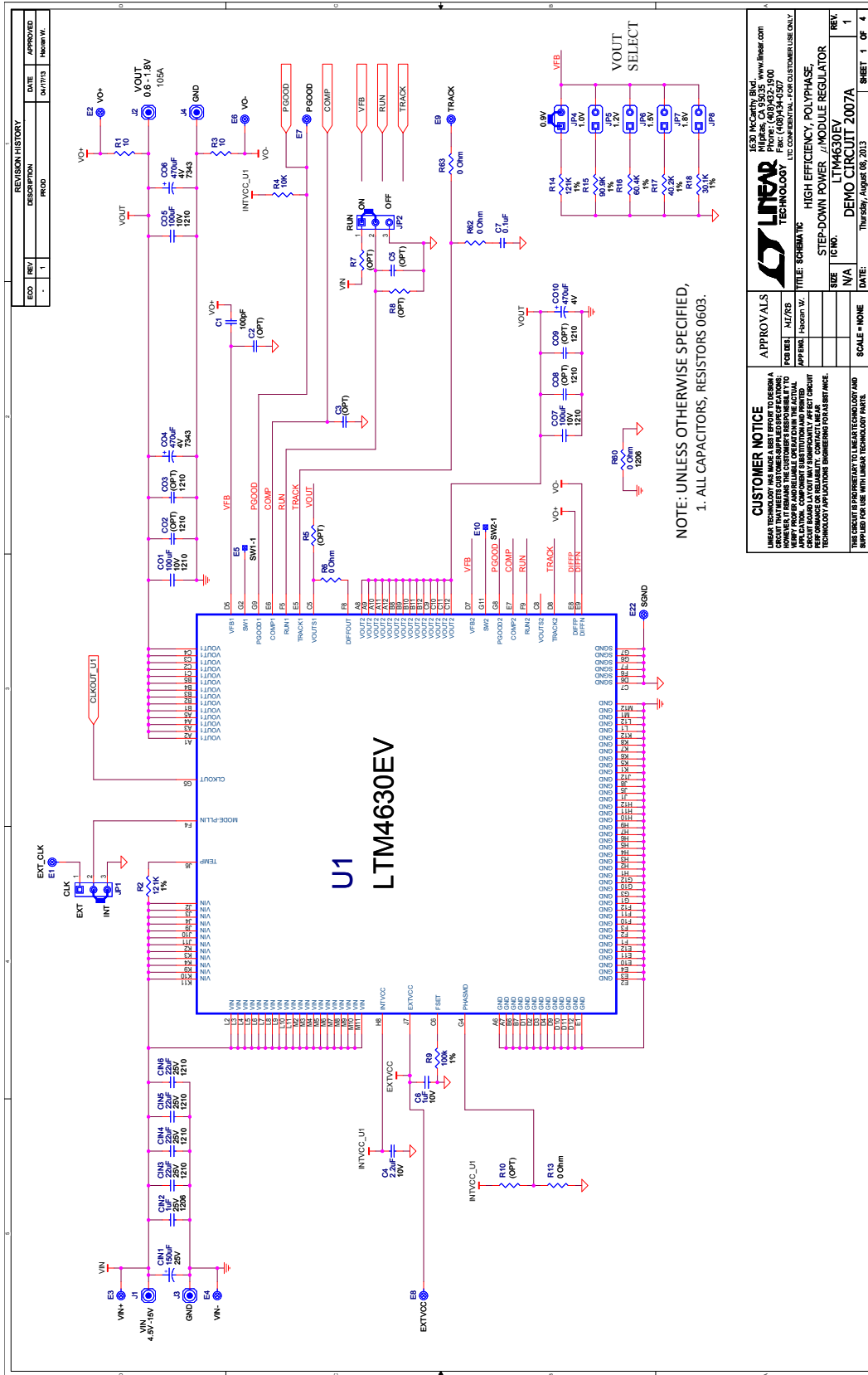

SCHEMATIC DIAGRAM

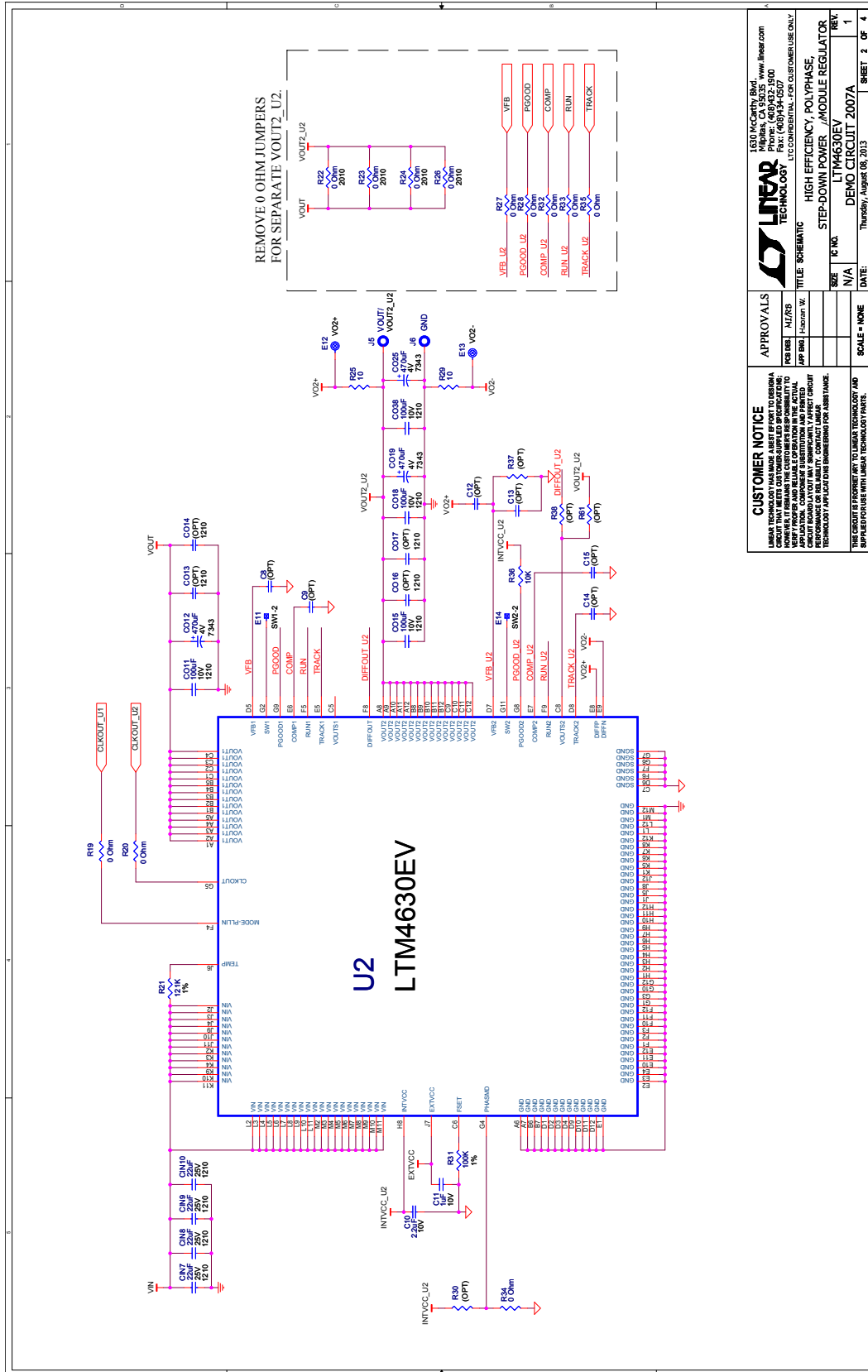

CUSTOMER NOTICE
 LINEAR TECHNOLOGY HAS MADE A BEST EFFORT TO DESIGN A CIRCUIT THAT MEETS CUSTOMER-SUPPLIED SPECIFICATIONS; WE DO NOT WARRANT OR RELY ON OUR EXPERTISE IN THE ACTUAL OPERATION OF THIS CIRCUIT. CUSTOMER SHOULD VERIFY THAT THE CIRCUIT BEHAVIORS AS INTENDED AND THAT THE CIRCUIT DOES NOT VIOLATE ANY APPLICABLE REGULATORY REQUIREMENTS OR REGULATORY CONTACT LOCAL REGULATORY AGENCIES FOR THE APPLICABLE JURISDICTION. CUSTOMER SHOULD CONTACT LINEAR TECHNOLOGY FOR ASSISTANCE WITH REGULATORY COMPLIANCE FOR THIS PRODUCT.

APPROVALS

DESIGNED BY:	MJ/RSD
APP'D AND ILLUSTRATED BY:	

LINEAR TECHNOLOGY
 1630 McCarty Blvd., www.linear.com
 Phone: (408) 352-3000
 Fax: (408) 354-0507
 LTC CONSUMER PART - FOR CUSTOMER USE ONLY

TITLE: SCHEMATIC
SIZE: N/A
DATE: Thursday, August 08, 2013

STEP-DOWN POWER, POLYPHASE, MODULE REGULATOR
LTM4630EV
DEMO CIRCUIT 2007A

SCALE: NONE

REV:	1
SHEET:	2 OF 4

DEMO MANUAL DC2007A-B

SCHEMATIC DIAGRAM

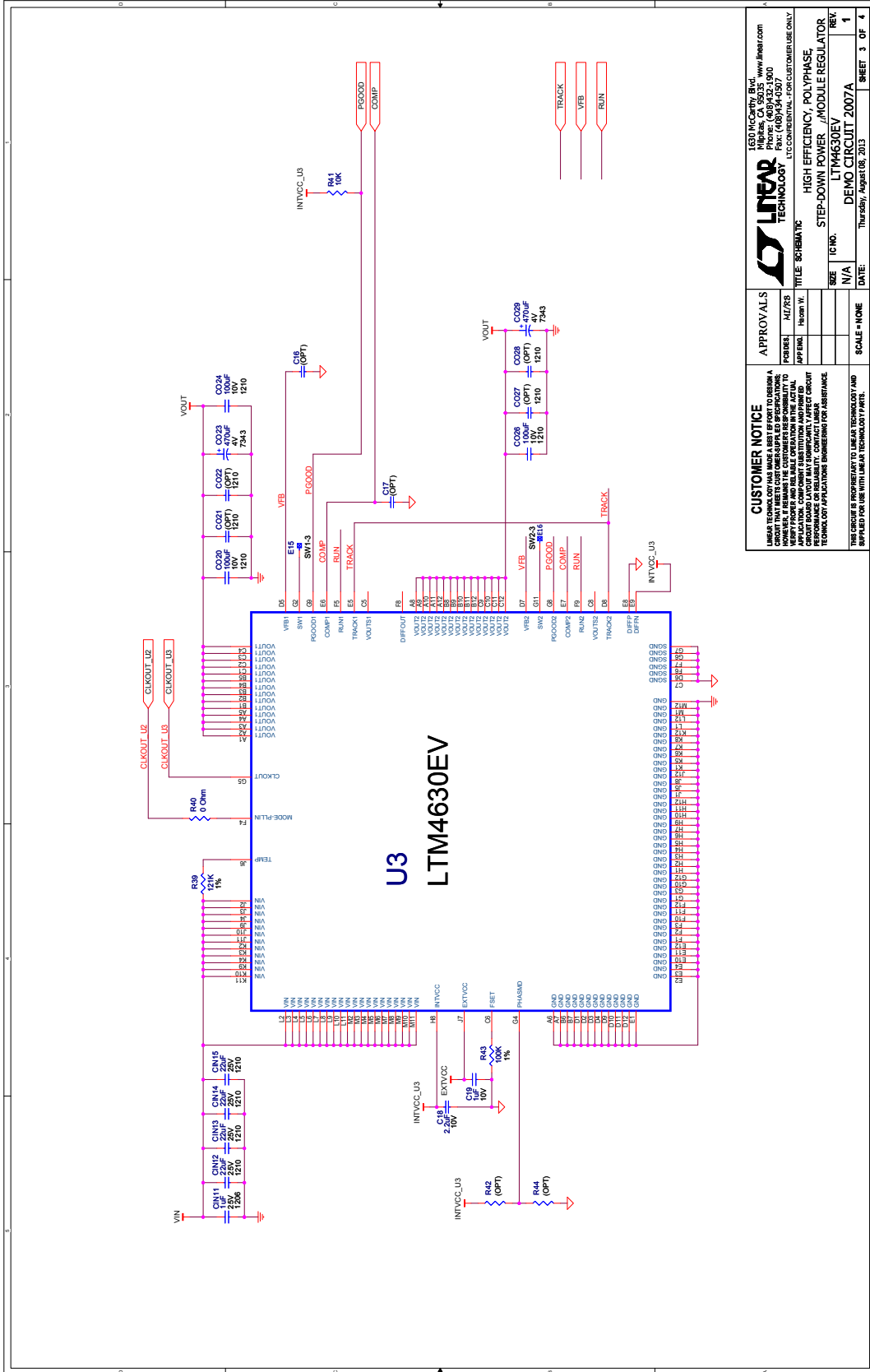

SCHEMATIC DIAGRAM

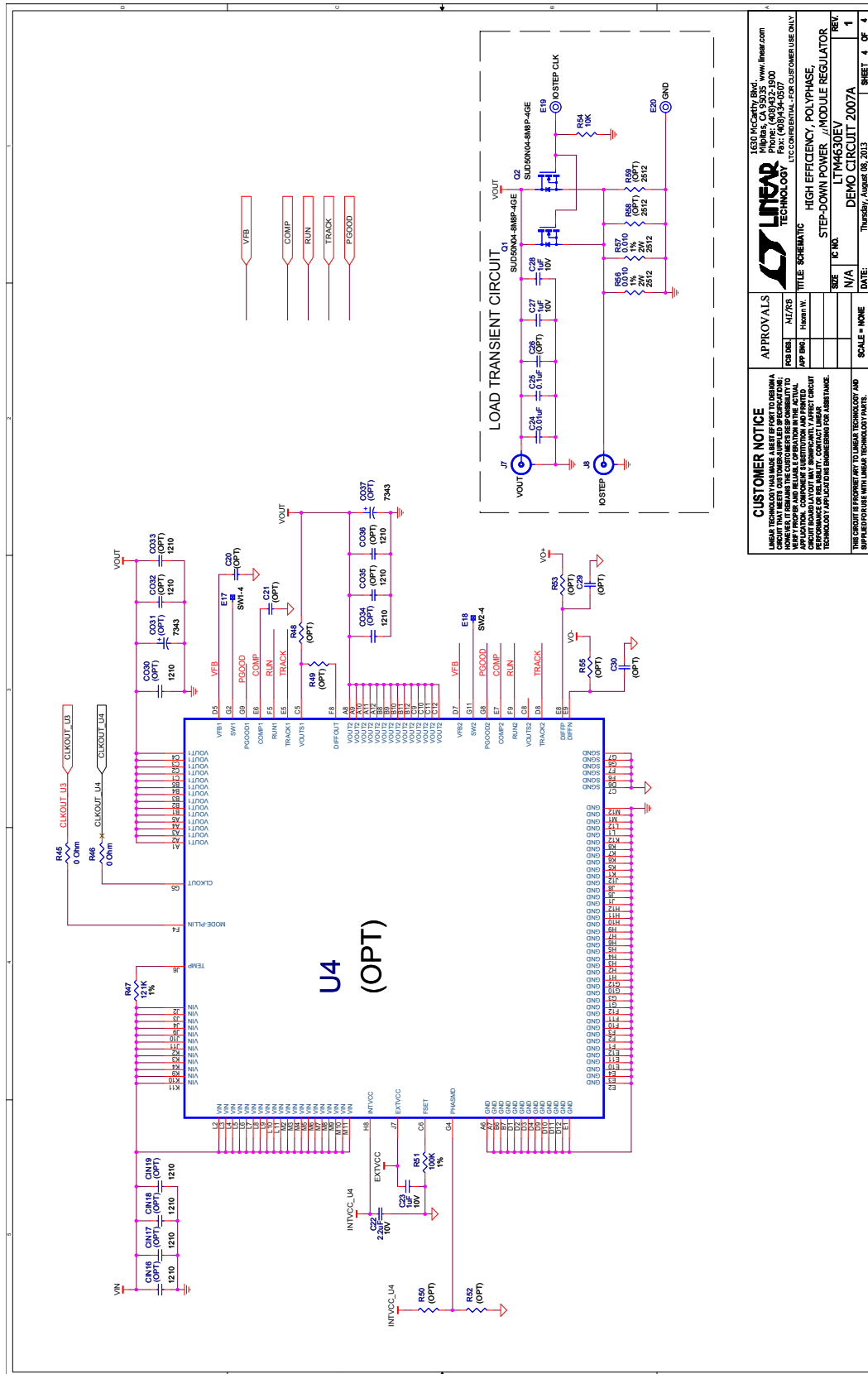

Information furnished by Linear Technology Corporation is believed to be accurate and reliable. However, no responsibility is assumed for its use. Linear Technology Corporation makes no representation that the interconnection of its circuits as described herein will not infringe on existing patent rights.

DEMO MANUAL DC2007A-B

DEMONSTRATION BOARD IMPORTANT NOTICE

Linear Technology Corporation (LTC) provides the enclosed product(s) under the following **AS IS** conditions:

This demonstration board (DEMO BOARD) kit being sold or provided by Linear Technology is intended for use for **ENGINEERING DEVELOPMENT OR EVALUATION PURPOSES ONLY** and is not provided by LTC for commercial use. As such, the DEMO BOARD herein may not be complete in terms of required design-, marketing-, and/or manufacturing-related protective considerations, including but not limited to product safety measures typically found in finished commercial goods. As a prototype, this product does not fall within the scope of the European Union directive on electromagnetic compatibility and therefore may or may not meet the technical requirements of the directive, or other regulations.

If this evaluation kit does not meet the specifications recited in the DEMO BOARD manual the kit may be returned within 30 days from the date of delivery for a full refund. **THE FOREGOING WARRANTY IS THE EXCLUSIVE WARRANTY MADE BY THE SELLER TO BUYER AND IS IN LIEU OF ALL OTHER WARRANTIES, EXPRESSED, IMPLIED, OR STATUTORY, INCLUDING ANY WARRANTY OF MERCHANTABILITY OR FITNESS FOR ANY PARTICULAR PURPOSE. EXCEPT TO THE EXTENT OF THIS INDEMNITY, NEITHER PARTY SHALL BE LIABLE TO THE OTHER FOR ANY INDIRECT, SPECIAL, INCIDENTAL, OR CONSEQUENTIAL DAMAGES.**

The user assumes all responsibility and liability for proper and safe handling of the goods. Further, the user releases LTC from all claims arising from the handling or use of the goods. Due to the open construction of the product, it is the user's responsibility to take any and all appropriate precautions with regard to electrostatic discharge. Also be aware that the products herein may not be regulatory compliant or agency certified (FCC, UL, CE, etc.).

No License is granted under any patent right or other intellectual property whatsoever. **LTC assumes no liability for applications assistance, customer product design, software performance, or infringement of patents or any other intellectual property rights of any kind.**

LTC currently services a variety of customers for products around the world, and therefore this transaction **is not exclusive**.

Please read the DEMO BOARD manual prior to handling the product. Persons handling this product must have electronics training and observe good laboratory practice standards. **Common sense is encouraged.**

This notice contains important safety information about temperatures and voltages. For further safety concerns, please contact a LTC application engineer.

Mailing Address:

Linear Technology
1630 McCarthy Blvd.
Milpitas, CA 95035

Copyright © 2004, Linear Technology Corporation

Mouser Electronics

Authorized Distributor

Click to View Pricing, Inventory, Delivery & Lifecycle Information:

[Analog Devices Inc.:](#)

[DC2007A-B](#)