

UNCONTROLLED DOCUMENT

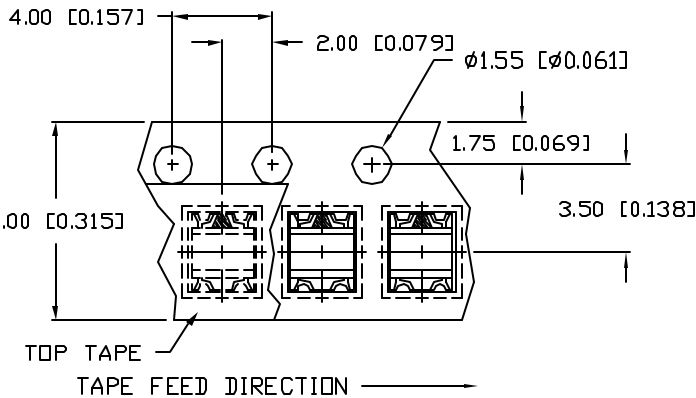

LEAD FREE REFLOW PROFILE

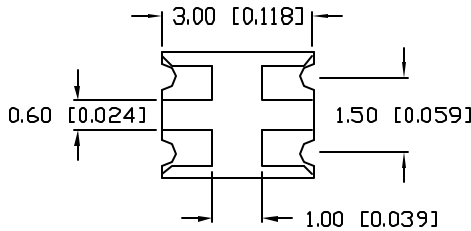
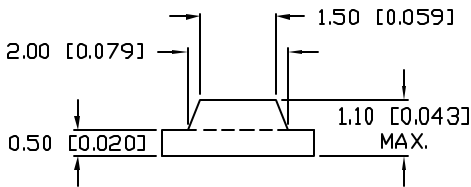
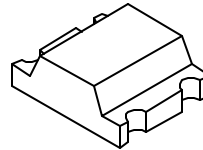
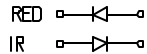
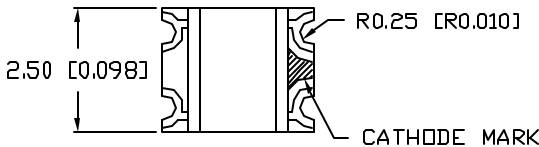
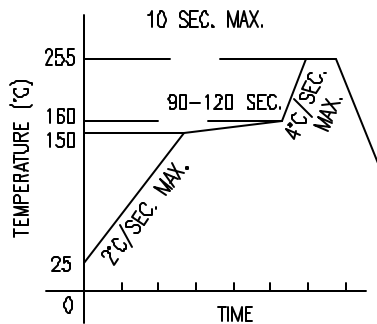

TOTAL TIME ABOVE 220°C IS 60 SECONDS MAX.

RECOMMENDED SOLDER PAD LAYOUT

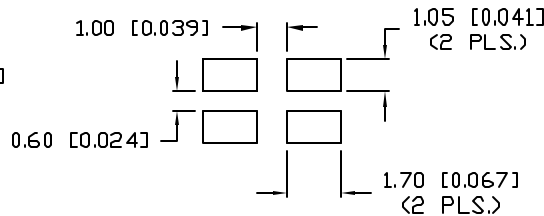

PART NUMBER
SML-LX2530SRELC-TR

REV.
B

REV.	E.C.N. NUMBER AND REVISION COMMENTS	DATE
A	E.C.N. #10967.	3.14.03
B	E.C.N. #11148.	7.14.05

ELECTRO-OPTICAL CHARACTERISTICS $T_A=25^\circ\text{C}$ $I_f=20\text{mA}$

PARAMETER	MIN	TYP	MAX	UNITS	TEST COND
PEAK WAVELENGTH		660 (RED)		nm	
		940 (IR)		nm	
FORWARD VOLTAGE (IR/SR)		1.2/1.8	1.6/2.5	V_f	
REVERSE VOLTAGE	5.0			V_r	$I_r=100\mu\text{A}$
AXIAL INTENSITY (SR)		75		mcd	$I_f=20\text{mA}$
		(IR)	1.7	mW/sr	$I_f=20\text{mA}$
VIEWING ANGLE		120		2x theta	
EMITTED COLOR:	RED/IR				
EPOXY LENS FINISH:	WATER CLEAR				

LIMITS OF SAFE OPERATION AT 25°C

PARAMETER	COLORS	MAX	UNITS
PEAK FORWARD CURRENT*	(IR/SR)	1200/160	mA
STEADY CURRENT	(IR/SR)	50/30	mA
POWER DISSIPATION		100	mW
DERATE FROM 25°C		-1.2	mW/°C
OPERATING TEMP.		-40 TO +85	°C
STORAGE TEMP.		-40 TO +85	°C

* $t < 10\mu\text{s}$

NOTES:

- THE CATHODE IS ORIENTED TOWARDS THE TAPE SPROCKET HOLE.

CAUTION: MOISTURE SENSITIVE DEVICE
PER JEDEC LEVEL 4 STANDARDS



UNCONTROLLED DOCUMENT

*UNLESS OTHERWISE SPECIFIED TOLERANCES PER DECIMAL PRECISION ARE: X=±1 (±0.030), XX=±0.5 (±0.020), XXX=±0.25 (±0.010), XXXX=±0.127 (±0.005). LEAD SIZE=±0.05 (±0.002), LEAD LENGTH=±0.75 (±0.030). MIN=+DECIMAL PRECISION MAX=-DECIMAL PRECISION

REV. B PART NUMBER SML-LX2530SRELC-TR

CONFIDENTIAL INFORMATION
THE INFORMATION CONTAINED IN THIS DOCUMENT IS THE PROPERTY OF LUMEX INC. EXCEPT AS SPECIFICALLY AUTHORIZED IN WRITING BY LUMEX INC., THE HOLDER OF THIS DOCUMENT SHALL KEEP ALL INFORMATION CONTAINED HEREIN CONFIDENTIAL AND SHALL PROTECT SAME IN WHOLE OR IN PART FROM DISCLOSURE AND DISSEMINATION TO ALL THIRD PARTIES.



290 E. HELEN ROAD
PALATINE, IL 60067-6976
PHONE: +1.847.359.2790
US WEB: www.lumex.com
TW WEB: www.lumex.com.tw

3.0mm x 2.5mm SURFACE MOUNT LED, BICOLOR,
660nm RED/940nm RED CHIPS,
WATER CLEAR LENS, TAPE AND REEL

RELIABILITY NOTE
OUR MANY YEARS OF EXPERIENCE DATA ACCUMULATION INDICATE THAT SOLDER HEAT IS A MAJOR CAUSE OF EARLY AND FUTURE FAILURE. PLEASE PAY ATTENTION TO YOUR SOLDERING PROCESS.

DRAWN BY: GB CHECKED BY: APPROVED BY: DATE: 04.08.02
PAGE: 1 OF 1
SCALE: N/A

Mouser Electronics

Authorized Distributor

Click to View Pricing, Inventory, Delivery & Lifecycle Information:

Lumex:

[SML-LX2530SRELC-TR](#)