

Typical unit

### FEATURES

- Small footprint DC/DC converter, ideal for high current applications
- 0.92" x 1.92" x 0.35" open frame package
- Wide range input voltages 9-36 and 18-75Vdc
- Assembly and attachment for RoHS-6 hazardous substance compliance
- Isolation up to 2250 VDC (basic), Q48 models
- Up to 30W total output power with overtemperature shutdown
- High efficiency synchronous rectifier forward topology
- Stable no-load operation with no required external components
- -40 to +85°C temperature range; see derating
- Certified to UL60950-1, CSA-C22.2 No. 234 safety approvals, and CE marking on 48V input only
- Extensive self-protection shut down features
- RoHS-6 hazardous substance compliant

### PRODUCT OVERVIEW

Wide range 4:1 inputs on the 0.92" x 1.92" x 0.35" converter are either 9 to 36 Volts DC (Q12 models) or 18 to 75 Volts DC (Q48 models), ideal for battery-powered and telecom equipment. Fixed output voltages from 3.3 VDC to 15 VDC are tightly regulated and may be trimmed within  $\pm 10\%$  of nominal output. Applications include small instruments, computer-based systems, data communications equipment, remote sensor systems, vehicle and portable electronics.

The UEI 30W Series includes full magnetic and optical isolation up to 2250 Volts DC (basic insulation), Q48 models. For connection to digital systems, the outputs offer fast settling to current step loads and tolerance of higher capacitive loads. Excellent ripple and noise specifications assure compatibility to circuits using CPU's, ASIC's, programmable logic

and FPGA's. No minimum load is required. For systems requiring controlled startup/shutdown, an external switch, transistor or digital logic may be used to activate the remote On/Off control.

A wealth of self-protection features avoid both converter and external circuit problems. These include input undervoltage lockout and overtemperature shutdown. The outputs current limit using the "hiccup" autorestart technique and the outputs may be short-circuited indefinitely. Additional features include output overvoltage and reverse conduction elimination.

The synchronous rectifier forward topology offers high efficiency for minimal heat buildup and "no fan" operation.

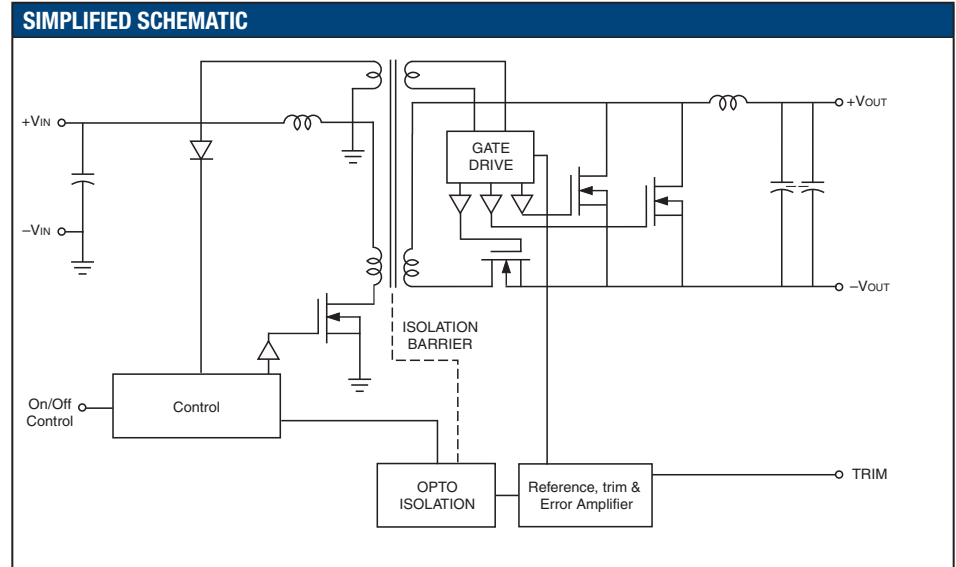

Typical topology is shown.



**PERFORMANCE SPECIFICATIONS SUMMARY AND ORDERING GUIDE**

Part Number <sup>①</sup>	Output						Input				Efficiency		Open Frame Package, C80		
	V <sub>out</sub> (V)	I <sub>out</sub> (A)	Power (W)	R/N (mVp-p)	Regulation (Max.)		V <sub>in</sub> Nom. (V)	Range (V)	I <sub>in</sub> , no load (mA)	I <sub>in</sub> , full load (A)	Min.	Typ.	Case	Pinout	
<b>Discontinued</b> UEI30-033-Q12P-C	3.3	9	29.7	25	35	±0.2%	±0.25%	24	9-36	130	1.39	87.3%	89%	C80	P21
<b>Discontinued</b> UEI30-033-Q48N-C	3.3	9	29.7	50	75	±0.2%	±0.25%	48	18-75	50	0.69	87%	89.5%	C80	P21
UEI30-050-Q12P-C	5	6	30	35	50	±0.2%	±0.2%	24	9-36	130	1.4	88%	89.5%	C80	P21
UEI30-050-Q48N-C	5	6	30	25	50	±0.1%	±0.2%	48	18-75	130	0.7	87%	88.8%	C80	P21
UEI30-120-Q12P-C	12	2.5	30	60	120	±0.2%	±0.1%	24	9-36	75	1.4	87.5%	89%	C80	P21
UEI30-120-Q48N-C	12	2.5	30	30	60	±0.2%	±0.1%	48	18-75	40	0.7	87.5%	89%	C80	P21
UEI30-150-Q12P-C	15	2	30	40	65	±0.2%	±0.1%	24	9-36	95	1.4	87.5%	89%	C80	P21
<b>Discontinued</b> UEI30-150-Q48N-C	15	2	30	50	100	±0.2%	±0.1%	48	18-75	50	0.7	87.5%	89.5%	C80	P21

① Please refer to the part number structure for additional options and complete ordering part numbers.  
 ② All specifications are at nominal line voltage and full load, +25°C, unless otherwise noted. See detailed specifications.

Output capacitors are 1 µF ceramic in parallel with 10 µF electrolytic. Input cap is 22 µF, low ESR. These I/O caps are necessary for our test equipment and may not be needed for your application.

**\* TO BE DISCONTINUED**

**\* NOTE:** the following models are **DISCONTINUED:**

- UEI30-033-Q12N-C    UEI30-033-Q48N-C    UEI30-150-Q48P-C    UEI30-150-Q48N-C
- UEI30-033-Q12P-C    UEI30-033-Q48P-C    UEI30-033-Q12PL2-C

**\* NOTE:** the following models are **TO BE DISCONTINUED:**

- UEI30-050-Q12N-C    UEI30-050-Q48P-C    UEI30-120-Q48P-C    UEI30-150-Q12PH-C
- UEI30-050-Q12PL1-C    UEI30-120-Q12N-C    UEI30-150-Q12N-C    UEI30-150-Q12PL1-C
- UEI30-050-Q48NH-C    UEI30-120-Q12NL2-    UEI30-150-Q12NL2-C    UEI30-150-Q12PL2-C

**PART NUMBER STRUCTURE**

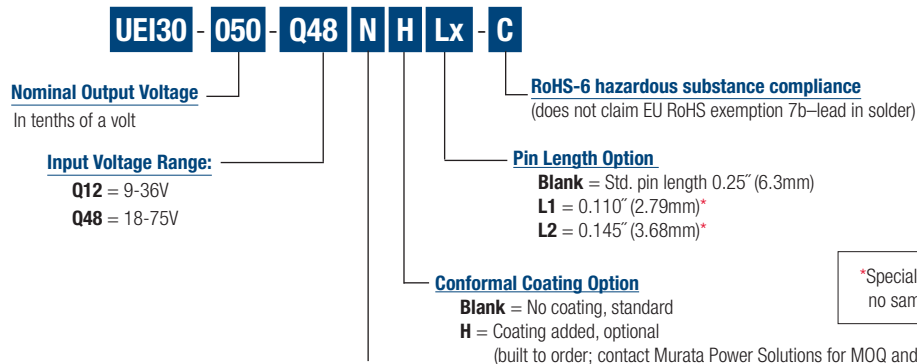

**On/Off Control Logic:**

- P = Positive
- N = Negative

Positive "P" logic is standard for Q12 models and optional special order for Q48 models. Negative "N" logic is standard for Q48 models and optional special order for Q12 models.

\*Special quantity order is required; no sample quantities available.

Note: Some model number combinations may not be available. Please contact Murata Power Solutions.

**Special Customer Configuration part numbers:**

- 1) **UEI30-033-Q12PH-31328** (3.3V<sub>out</sub> @ 30W, Positive Logic, Conformal Coating, Hipot Tested to 2,000Vrms)
- 2) **UEI30-050-Q12PH-31329** (5V<sub>out</sub> @ 30W, Positive Logic, Conformal Coating, Hipot Tested to 2,000Vrms)
- 3) **UEI30-050-Q12PL1-C-NI** (5V<sub>out</sub> @ 30W, Positive Logic, 0.110" Pin Length, Control loop changes for large capacitive load)

**FUNCTIONAL SPECIFICATIONS**

INPUT CHARACTERISTICS													
Model Family	Start-up threshold	Under-voltage Shut-down	Reflected (back) Ripple Current <sup>2</sup>	Input Current				Recommended Fast-Blow Fuse	Internal Input Filter Type	Reverse Polarity Protection	Remote On/Off Control		
				Inrush Transient	Output Short Circuit	Low Line	Standby Mode				On/Off Current	Positive Logic	Negative Logic
UEI30-033-Q12P-C	9.5	8.5	30	0.05	50	3.75	1	L-C	None, install external fuse	1	OFF=Gnd pin or -0.7 to +1.2V max. ON=open pin or +10 to +15V max. ON=Gnd pin or -0.7 to +1.2V max.	OFF=open pin or +10 to +15V max. ON=Gnd pin or -0.7 to +1.2V max.	
UEI30-033-Q48N-C	17.3	16.0*				1.89							
UEI30-050-Q12P-C	9.5	8.0				3.75							
UEI30-050-Q48N-C	17.0	16.2				1.88							
UEI30-120-Q12P-C	9.5	8.3				3.75	3						
UEI30-120-Q48N-C	17.0	16.5				1.85	1						
UEI30-150-Q12P-C	9.5	8.3				80	3.72						1
UEI30-150-Q48N-C	16.9	16.3				50	1.83						1

\*Specified at half load

OUTPUT CHARACTERISTICS												
Model Family	V <sub>out</sub> Accuracy	Adjustment Range	Temperature Coefficient	Capacitive Loading Max.		Overvoltage protection		Minimum loading	OV protection method	Ripple/Noise (20 MHz bandwidth) <sup>8</sup>	Line/Load Regulation	Efficiency
	50% Load			Low ESR <0.02Ω Max, resistive load	Hiccup auto-start after fault removal							
	% of V <sub>NOM</sub>					% of V <sub>NOM</sub>	% of V <sub>out</sub> / °C					
UEI30-033-Q12P-C	2	±10	±0.02	2,000			5.0	No	Magnetic feedback	See ordering guide		
UEI30-033-Q48N-C	1						5.0					
UEI30-050-Q12P-C							7.0					
UEI30-050-Q48N-C							7.3					
UEI30-120-Q12P-C							15.5					
UEI30-120-Q48N-C							14.1					
UEI30-150-Q12P-C							18.5					
UEI30-150-Q48N-C							24					

ABSOLUTE MAXIMUM RATINGS			
Input Voltage	Q12 models	Volts, max. continuous	0-36 VDC to rated specifications
		Volts, transient, 100 mSec	50 VDC, no damage
Input Voltage	Q48 models	Volts, max. continuous	0-75 VDC to rated specifications
		Volts, transient, 100 mSec	100 VDC, no damage
On/Off control, referred to -Vin		-0.7 V. min to +15V max.	
Input Reverse Polarity Protection		None, install external fuse	
Output Overvoltage		V <sub>out</sub> nom. +20% max.	
Output Current		Current-limited. Devices can withstand sustained short circuit without damage. The outputs are not intended to accept appreciable reverse current.	
Overtemperature Protection		Device includes electronic overtemperature shutdown protection under normal operation.	
Storage Temperature		-55 to +125° C.	
Lead Temperature		See soldering specifications	

**Absolute Maximum Ratings**

Absolute maximums are stress ratings. Exposure of devices to greater than any of these conditions may adversely affect long-term reliability. Proper operation under conditions other than those listed in the Performance/Functional Specifications Table is not implied nor recommended.

**Maximum Ratings Notes**

The transient specifications indicate that sample lots were successfully tested for 100 mS at the transient stress voltage and were not damaged. As a practical matter in your application, it is often difficult to determine how long an input overvoltage was applied. Therefore, do not exceed the continuous voltage rating.

ISOLATION CHARACTERISTICS				
Model Family	Input to Output	Isolation Resistance	Isolation Capacitance	Insulation Safety Rating
	Min	Min	pF	
	VDC	MΩ		
UEI30-033-Q12P-C	2000	10	1000	Basic
UEI30-033-Q48N-C	2250		1000	
UEI30-050-Q12P-C	2000		1000	
UEI30-050-Q48N-C	2250		1000	
UEI30-120-Q12P-C	2000		1500	
UEI30-120-Q48N-C	2250		1500	
UEI30-150-Q12P-C	2000		1500	
UEI30-150-Q48N-C	2250		2000	

DYNAMIC CHARACTERISTICS				
Model Family	Dynamic Load Response (50-75-50% load step)	Start-up Time		Switching Frequency
		V <sub>IN</sub> to V <sub>OUT</sub> regulated (Max.)	Remote On/Off to V <sub>OUT</sub> regulated (Max.)	
		µsec	mSec	
UEI30-033-Q12P-C	120 to 2%	50	50	275
UEI30-033-Q48N-C	180 to 2%			280
UEI30-050-Q12P-C	80 to 2%			275
UEI30-050-Q48N-C	100 to 1%			275
UEI30-120-Q12P-C	200 to 1%			275
UEI30-120-Q48N-C	150 to 1%			275
UEI30-150-Q12P-C	150 to 1%			275
UEI30-150-Q48N-C	150 to 1%			275

MISCELLANEOUS CHARACTERISTICS									
Model Family	Output Current Limit Inception	Output Short Circuit Protection Method	Output Short Circuit Current	Output Short Circuit Duration (output shorted to ground)	Output Pre-biased setup	Operating Temperature Range	Storage temperature range	Thermal protection/shutdown	Relative Humidity, non-condensing
	98% of V <sub>OUT</sub> , after warmup		A				°C	°C	°C
	A		A						
UEI30-033-Q12P-C	11.5	Current limiting, hiccup auto restart	0.3 max.	Continuous	Monotonic (external V <sub>OUT</sub> < V <sub>SET</sub> )	-40 to +85°C; with Derating (see Notes)	-55 to 125°C	115	To +85°C/ 85% RH
UEI30-033-Q48N-C	11.2		0.3 max.						
UEI30-050-Q12P-C	7.9		3.0						
UEI30-050-Q48N-C	7.4		0.3 max.						
UEI30-120-Q12P-C	4.1		1.5						
UEI30-120-Q48N-C	3.65		0.75						
UEI30-150-Q12P-C	3.0		0.5						
UEI30-150-Q48N-C	3.25		0.1 max.						

**Specification Notes:**

- (1) All models are tested and specified with external 1 µF and 10 µF parallel output capacitors and a 22 µF external input capacitor. All capacitors are low ESR types. These capacitors are necessary to accommodate our test equipment and may not be required to achieve specified performance in your applications. All models are stable and regulate within spec under no-load conditions.
- All specifications are typical unless noted. General conditions for Specifications are +25 deg. C, V<sub>IN</sub>=nominal, V<sub>OUT</sub>=nominal, full load. Adequate airflow must be supplied for extended testing under power.
- (2) Input Back Ripple Current is tested and specified over a 5 Hz to 20 MHz bandwidth. Input filtering is C<sub>in</sub>=33 µF, 100V, C<sub>bus</sub>=220 µF, 100V, L<sub>bus</sub>=12 µH.
- (3) Note that Maximum Power Derating curves indicate an **average** current at nominal input voltage. At higher temperatures and/or lower airflow, the DC/DC converter will tolerate brief full current outputs if the total RMS current over time does not exceed the Derating curve. All Derating curves are presented at sea level altitude. Be aware of reduced power dissipation with increasing density altitude.
- (4) Refer to page 10 for MTBF values.
- (5) The On/Off Control is normally selected by a switch or an open collector or open drain transistor. But it may also be driven with external logic or by applying appropriate external voltages which are referenced to Input Common and do not exceed the On/Off voltage specifications.
- (6) Output current limiting begins when the output voltage degrades approximately 2% from the selected setting.
- (7) The outputs are not intended to sink appreciable reverse current.
- (8) Output noise may be further reduced by adding an external filter. Low voltage logic circuits may have a small voltage margin between logic ZERO and logic ONE, requiring noise suppression. **Use only as much output filtering as needed** to achieve your noise requirements. Excessive output capacitance can retard transient response or possibly cause instability. Low ESR ceramic capacitors may degrade dynamic

- performance. Be sure to thoroughly test your system under full load with all components installed.
- (9) All models are fully operational and meet published specifications, including "cold start" at -40°C. (10) Regulation specifications describe the deviation as the line input voltage or output load current is varied from a nominal midpoint value to either extreme.
- (11) The output overvoltage protection is automatic recovery. The overvoltage may occur either from internal failure or from an external forcing voltage as in a shared power system.
- (12) Output overvoltage and short circuit protection is non-latching. When the overvoltage fault is removed, the converter will immediately recover. After an output overcurrent or short circuit, "hiccup" operation repeatedly attempts to restart the converter with a brief, full-current output. If the overcurrent condition still exists, the restart current will be removed and then tried again. This short current pulse prevents overheating and damaging the converter. Once the fault is removed, the converter immediately resumes normal operation.
- (13) Do not exceed maximum power specifications when adjusting the output trim.
- (14) At zero output current, the output may contain low frequency components which exceed the ripple specification. The output may be operated indefinitely with no load.
- (15) If reverse polarity is accidentally applied to the input, to ensure reverse input protection with full output load, always connect an external input **fuse** in series with the +V<sub>in</sub> input. Use approximately twice the full input current rating with nominal input voltage.
- CAUTION:** This product is not internally fused. To comply with safety agency certifications and to avoid injury to personnel or equipment, the user **must** connect an external fast-blow fuse to the input terminals. See fuse information.

**PERFORMANCE DATA**

**UEI30-033-Q12**

Efficiency vs. Line Voltage and Load Current @ 25°C

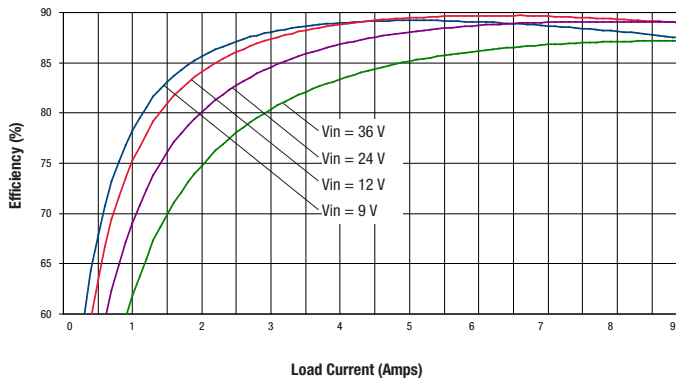

Maximum Current Temperature Derating @Sea Level  
(VIN = 12V, airflow is from input to output)

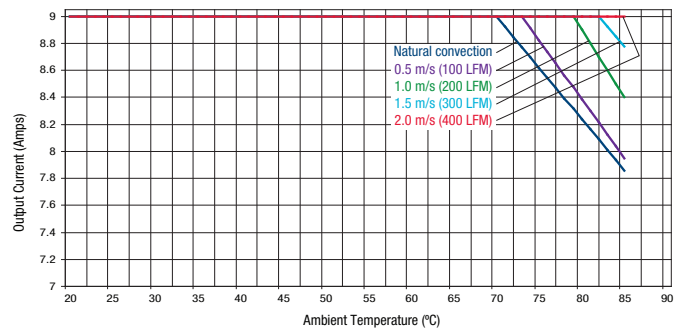

**UEI30-033-Q48**

Efficiency vs. Line Voltage and Load Current @ 25°C

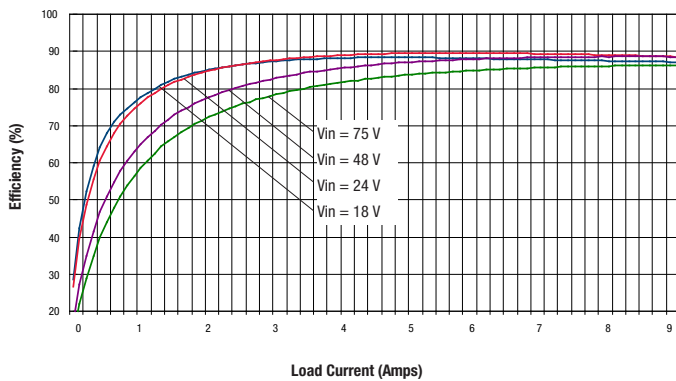

Maximum Current Temperature Derating @Sea Level  
(VIN = 24V, airflow is from input to output)

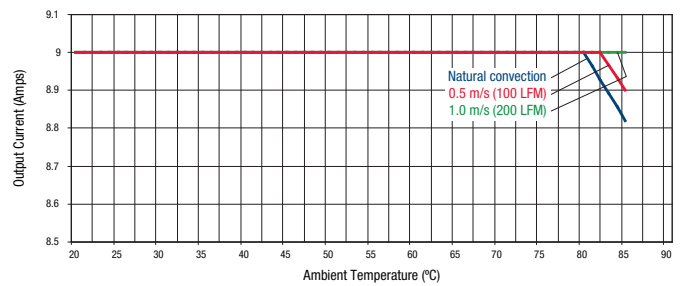

**UEI30-033-Q48**

Maximum Current Temperature Derating @Sea Level  
(VIN = 48V, airflow is from input to output)

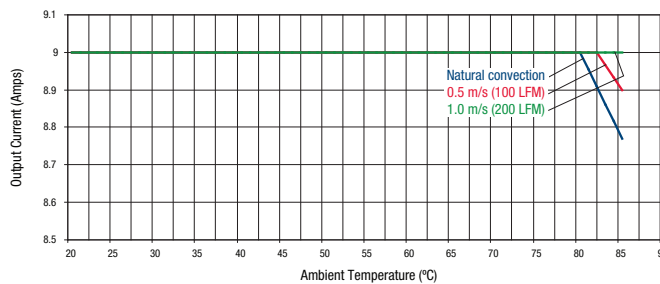

**PERFORMANCE DATA**

**UEI30-050-Q12**

Efficiency vs. Line Voltage and Load Current @ 25°C

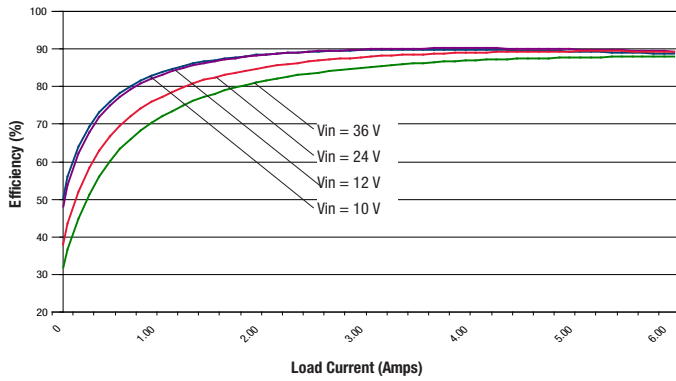

Maximum Current Temperature Derating @Sea Level  
(VIN = 12 or 24V, airflow is from input to output)

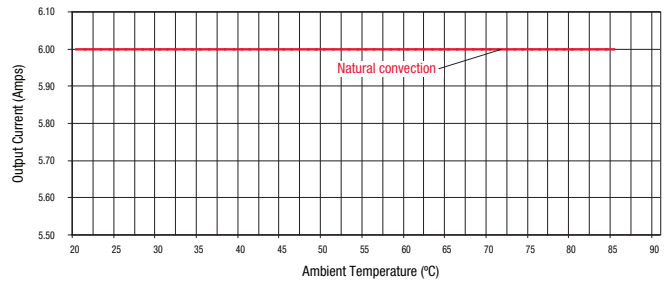

**UEI30-050-Q48**

Efficiency vs. Line Voltage and Load Current @ 25°C

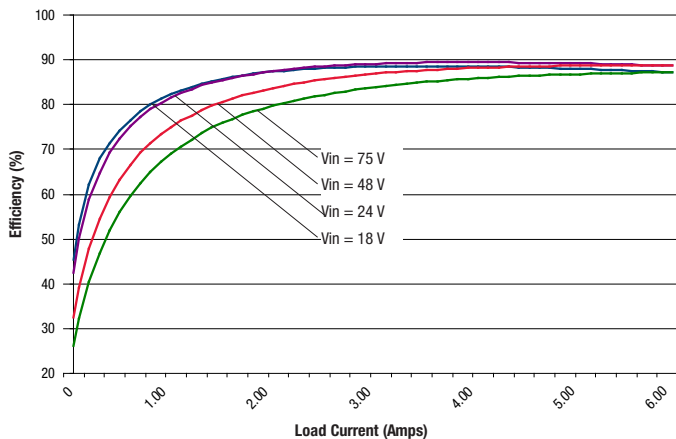

Maximum Current Temperature Derating @Sea Level  
(VIN = 18V, transverse airflow)

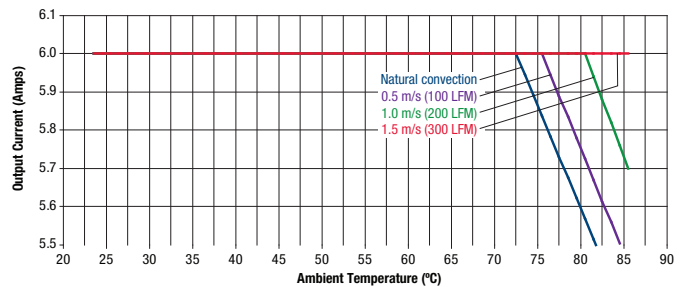

Maximum Current Temperature Derating @Sea Level  
(VIN = 24V, transverse airflow)

**UEI30-050-Q48**

Maximum Current Temperature Derating @Sea Level  
(VIN = 48V, transverse airflow)

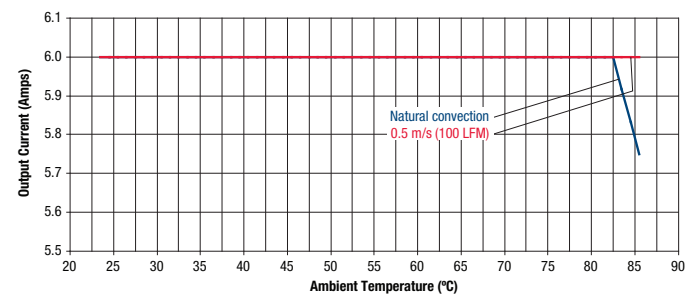
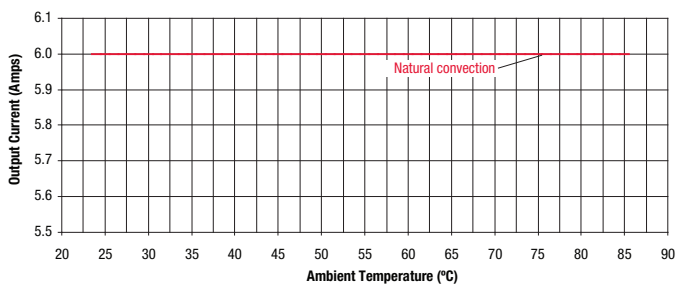

**PERFORMANCE DATA**

**UEI30-120-Q12**

Efficiency vs. Line Voltage and Load Current @ 25°C

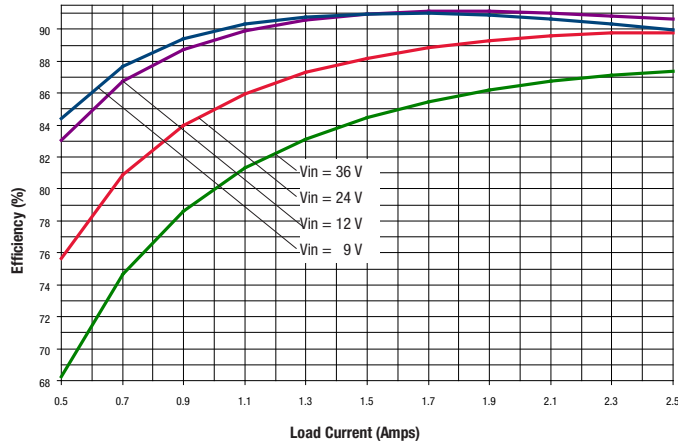

Power Dissipation vs. Load Current @ 25°C

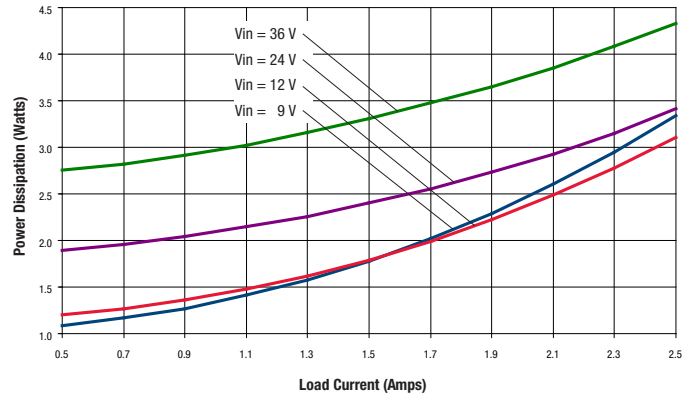

Maximum Current Temperature Derating @Sea Level  
(VIN = 9-24V, transverse airflow)

**UEI30-120-Q12**

Maximum Current Temperature Derating @Sea Level  
(VIN = 36V, transverse airflow)

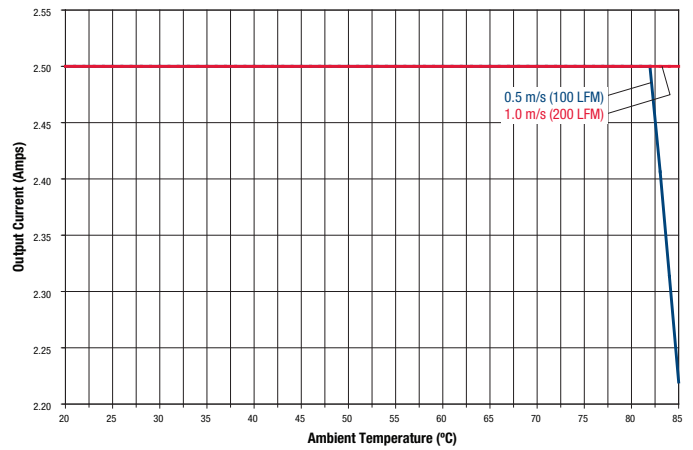
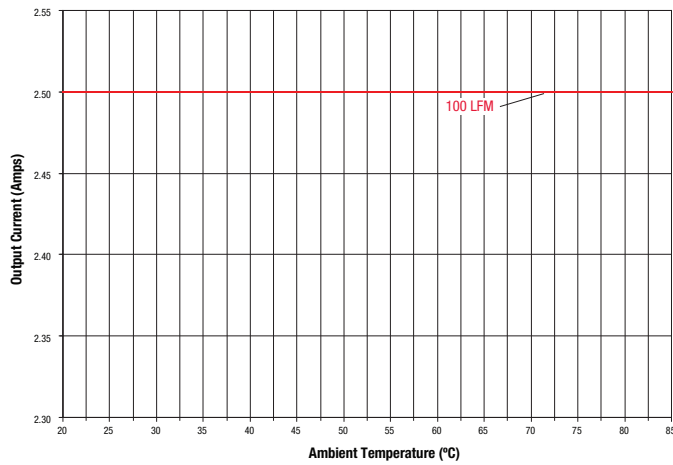

**PERFORMANCE DATA**

**UEI30-120-Q48**

Efficiency vs. Line Voltage and Load Current @ 25°C

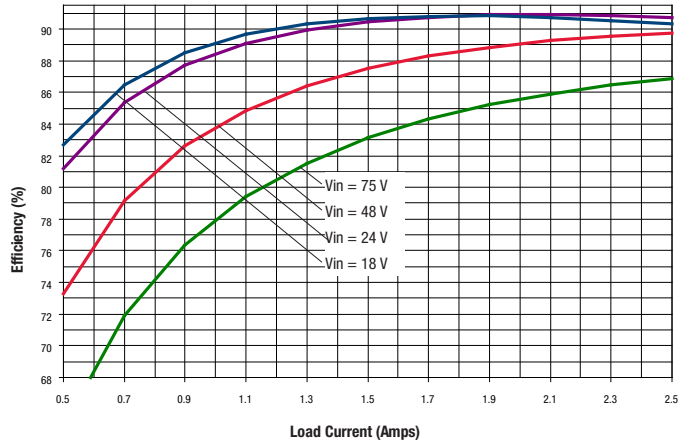

Power Dissipation vs. Load Current @ 25°C

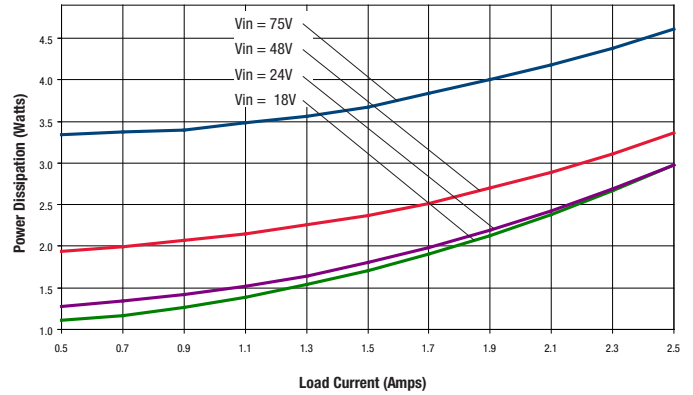

Maximum Current Temperature Derating @Sea Level  
(Vin = 18-48V, transverse airflow)

**UEI30-120-Q48**

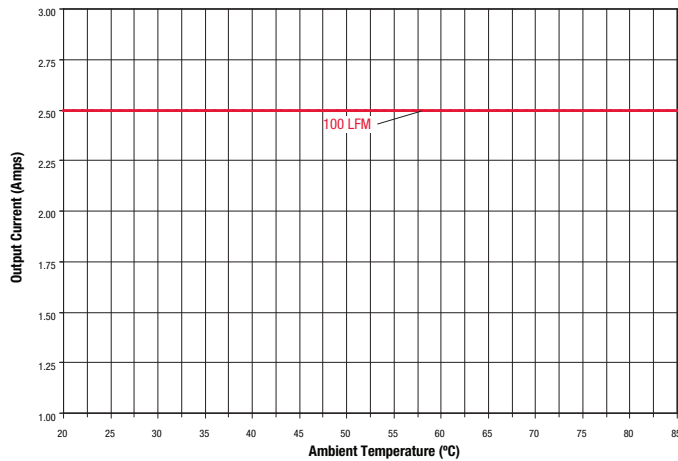

Maximum Current Temperature Derating @Sea Level  
(Vin = 75V, transverse airflow)

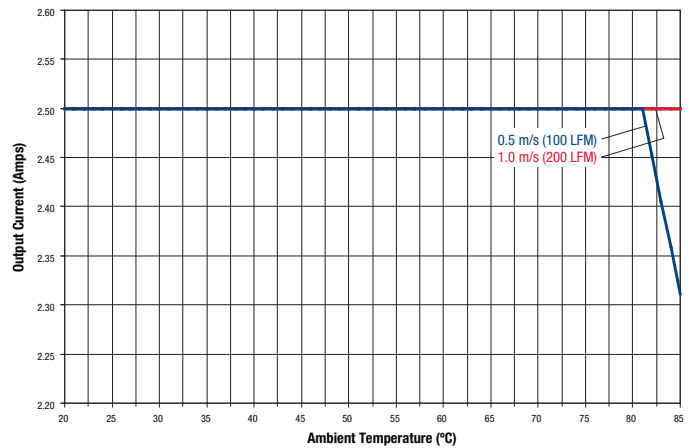



**PERFORMANCE DATA**

**Efficiency vs. Line Voltage and Load Current @ 25°C**

**UEI30-150-Q12**

**Power Dissipation vs. Load Current @ 25°C**

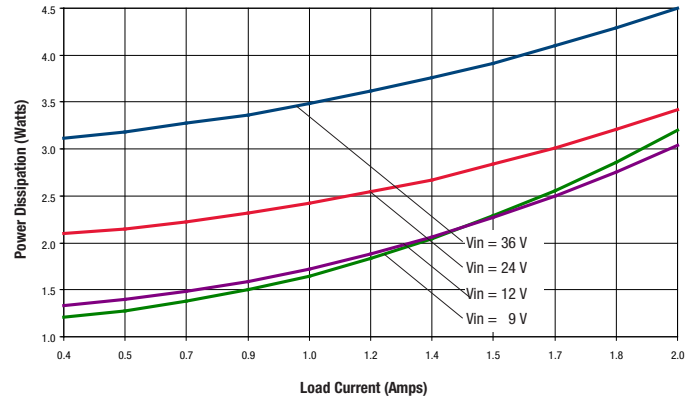
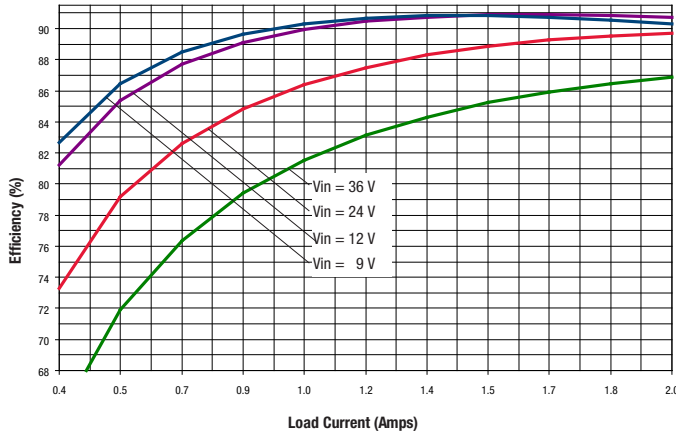

**Maximum Current Temperature Derating @Sea Level (VIN = 9-24V, transverse airflow)**

**UEI30-150-Q12**

**Maximum Current Temperature Derating @Sea Level (VIN = 36V, transverse airflow)**

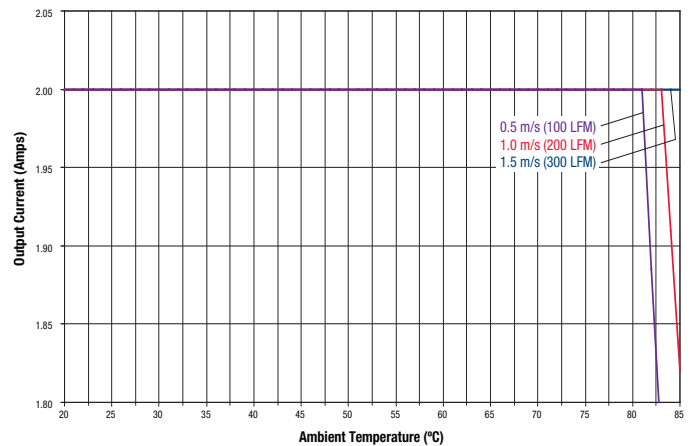
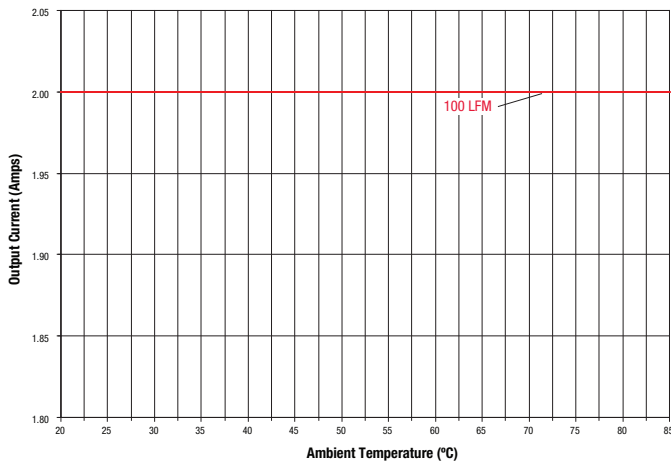

**UEI30-150-Q12**

**Maximum Current Temperature Derating @Sea Level (Natural convection)**

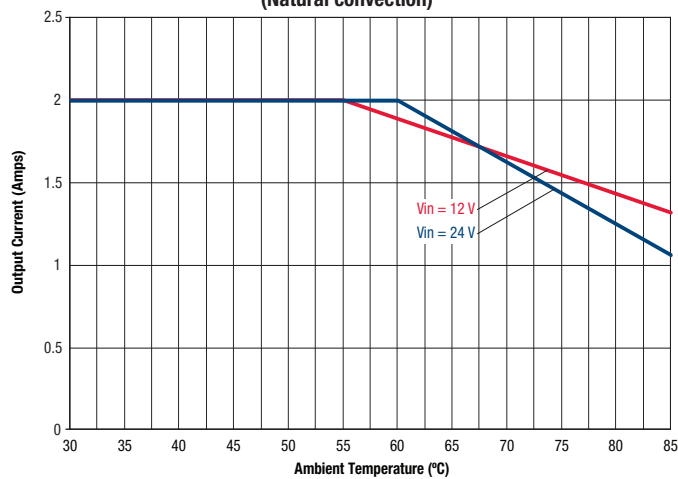

**PERFORMANCE DATA**

**UEI30-150-Q48**

**Efficiency vs. Line Voltage and Load Current @ 25°C**

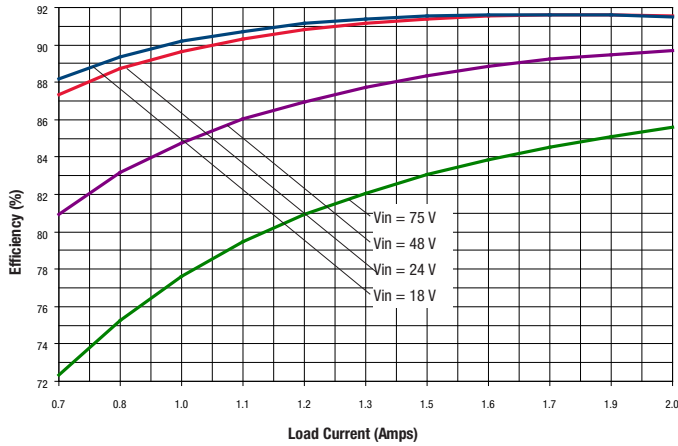

**Power Dissipation vs. Load Current @ 25°C**

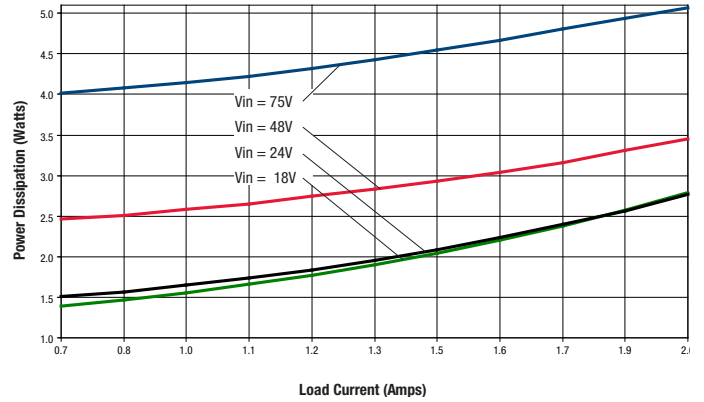

**Maximum Current Temperature Derating @Sea Level  
(VIN = 18-48V, transverse airflow)**

**UEI30-150-Q48**

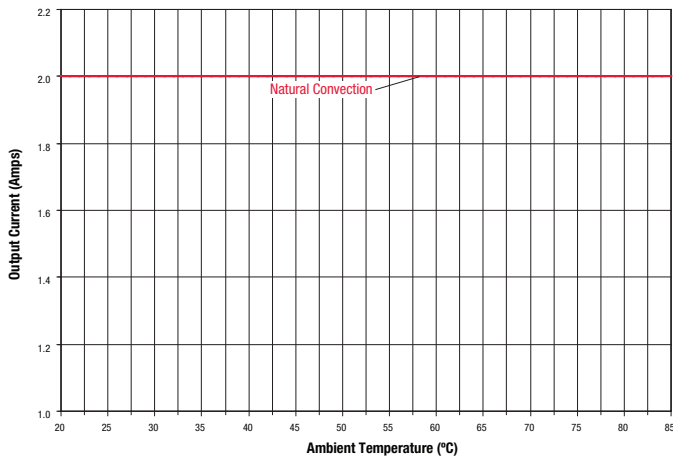

**Maximum Current Temperature Derating @Sea Level  
(VIN = 75V, transverse airflow)**

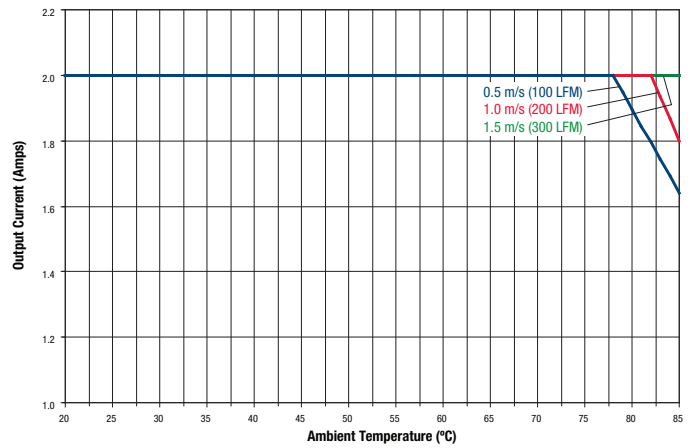

**MECHANICAL SPECIFICATIONS**

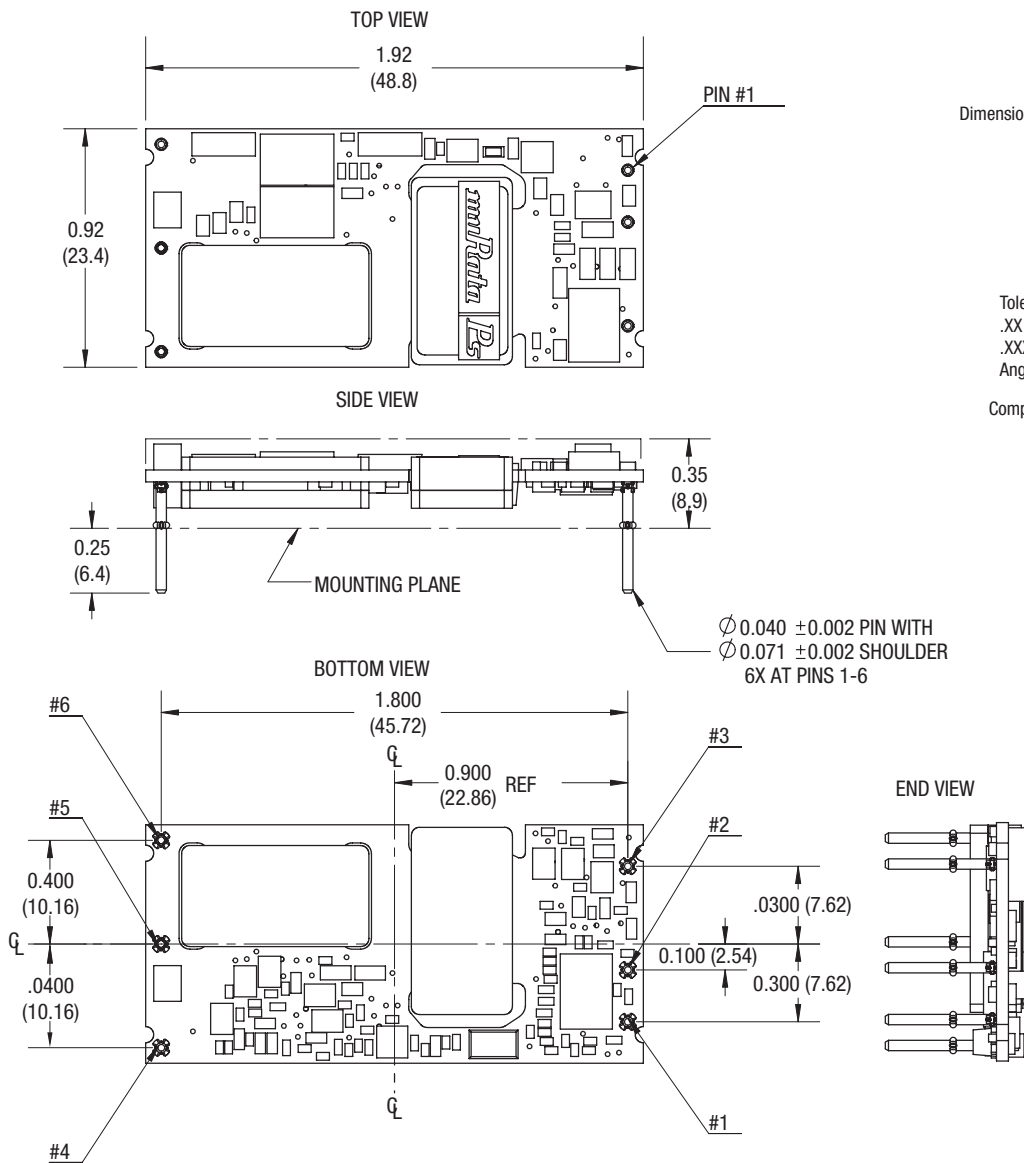

Dimensions are in inches (mm shown for ref. only).

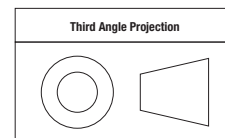

Tolerances (unless otherwise specified):  
 .XX ± 0.02 (0.5)  
 .XXX ± 0.010 (0.25)  
 Angles ± 2°

Components are shown for reference only.

**UEI30 Open Frame  
30W  
Package C80**

PHYSICAL CHARACTERISTICS	
Pin material	Copper alloy with gold plate over nickel underplate
Pin diameter	0.04" (1.016mm)
Pin Finish	Gold plate
Weight	0.53 oz (15g)
Electromagnetic interference	EN55022/CISPR22 (requires external filter)
Flammability Rating	UL 94V-0
Safety	Designed to meet IEC/EN/UL/cUL 60950-1, CSA-C22.2 No. 60950-1

INPUT/OUTPUT CONNECTIONS			
Pin	Function P21	Pin	Function P21
1	+ Vin	4	+ Vout
2	- Vin	5	- Vout
3	Remote On/Off*	6	Trim

\* The Remote On/Off can be provided with either positive (P suffix) or negative (N suffix) logic.

**SHIPPING TRAYS AND BOXES**

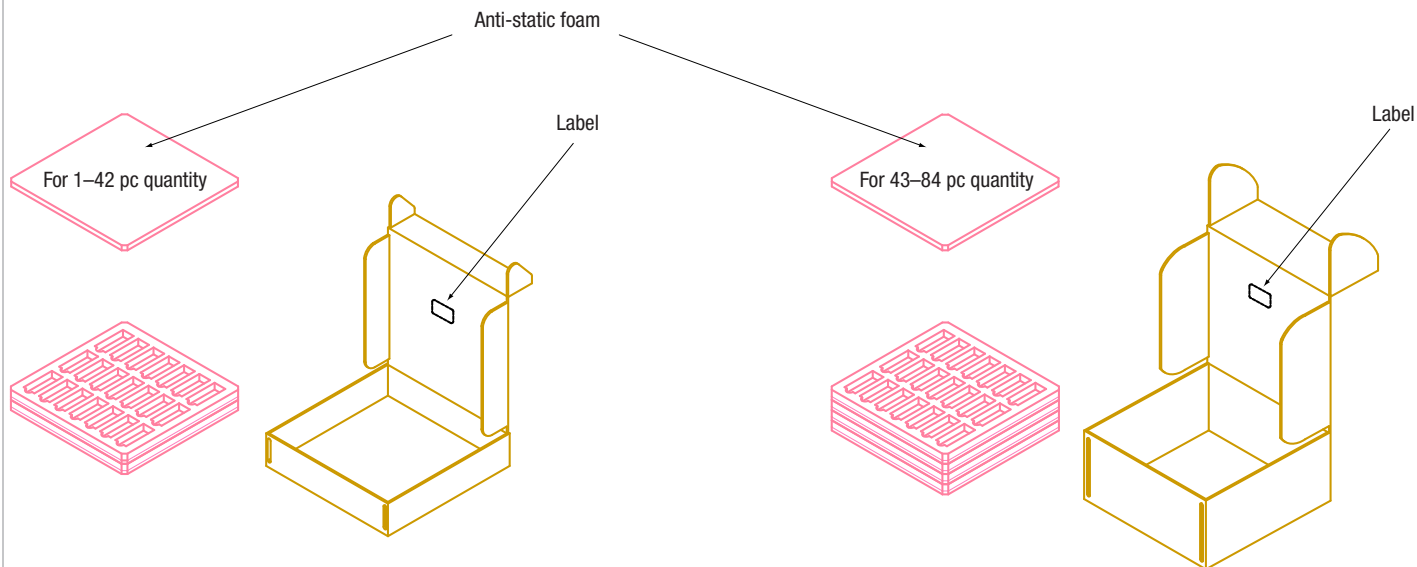

**SHIPPING TRAY**

UEI30 modules are supplied in a 21-piece (3-by-7) shipping tray. The tray is an anti-static closed-cell polyethylene foam. Dimensions are shown below.

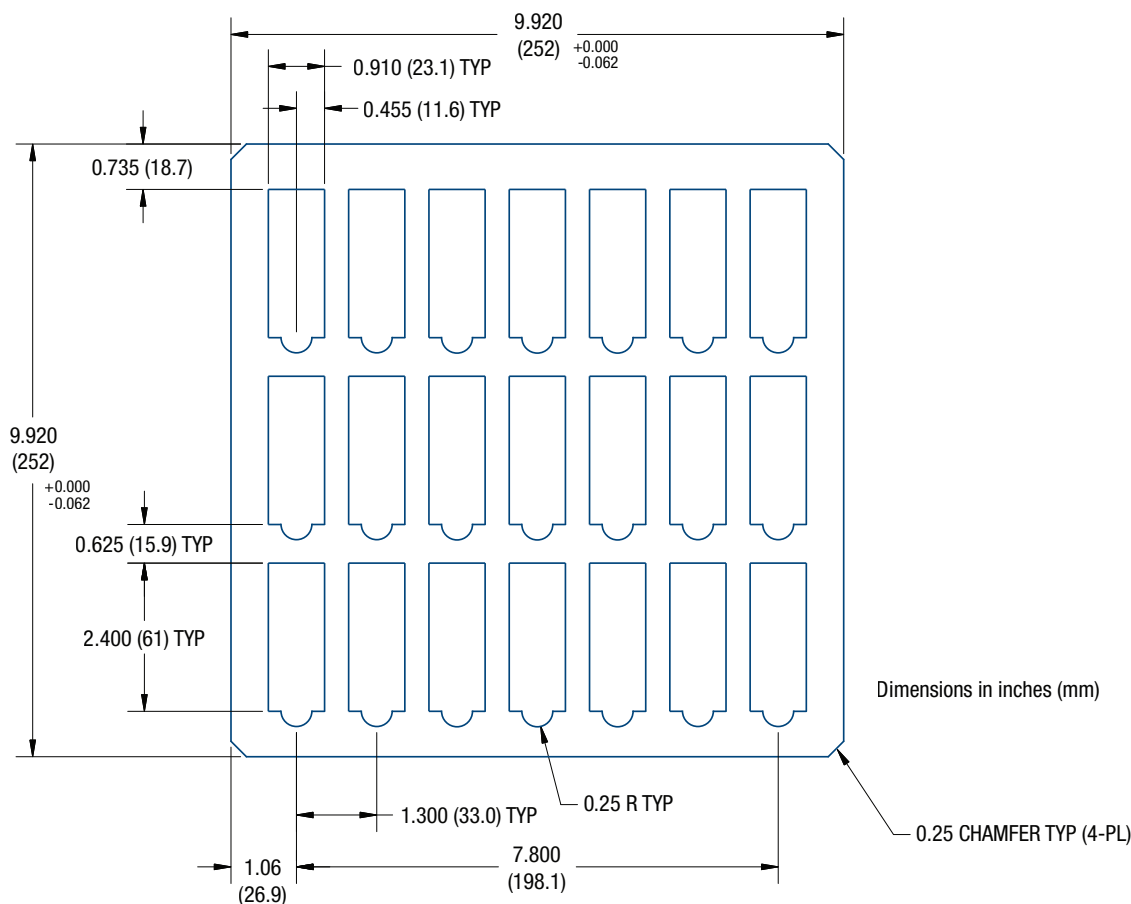

Dimensions in inches (mm)

**TECHNICAL NOTES**

**Input Fusing**

Certain applications and/or safety agencies may require fuses at the inputs of power conversion components. Fuses should also be used when there is the possibility of sustained input voltage reversal which is not current-limited. For greatest safety, we recommend a fast blow fuse installed in the ungrounded input supply line.

The installer must observe all relevant safety standards and regulations. For safety agency approvals, install the converter in compliance with the end-user safety standard.

**Input Reverse-Polarity Protection**

If the input voltage polarity is reversed, an internal diode will become forward biased and likely draw excessive current from the power source. If this source is not current-limited or the circuit appropriately fused, it could cause permanent damage to the converter.

**Input Under-Voltage Shutdown and Start-Up Threshold**

Under normal start-up conditions, converters will not begin to regulate properly until the rising input voltage exceeds and remains at the Start-Up Threshold Voltage (see Specifications). Once operating, converters will not turn off until the input voltage drops below the Under-Voltage Shutdown Limit. Subsequent restart will not occur until the input voltage rises again above the Start-Up Threshold. This built-in hysteresis prevents any unstable on/off operation at a single input voltage.

Users should be aware however of input sources near the Under-Voltage Shutdown whose voltage decays as input current is consumed (such as capacitor inputs), the converter shuts off and then restarts as the external capacitor recharges. Such situations could oscillate. To prevent this, make sure the operating input voltage is well above the UV Shutdown voltage AT ALL TIMES.

**Start-Up Delay**

Assuming that the output current is set at the rated maximum, the Vin to Vout Start-Up Delay (see Specifications) is the time interval between the point when the rising input voltage crosses the Start-Up Threshold and the fully loaded regulated output voltage enters and remains within its specified regulation band. Actual measured times will vary with input source impedance, external input capacitance, input voltage slew rate and final value of the input voltage as it appears at the converter.

These converters include a soft start circuit to moderate the duty cycle of the PWM controller at power up, thereby limiting the input inrush current.

The On/Off Remote Control interval from inception to Vout regulated assumes that the converter already has its input voltage stabilized above the Start-Up Threshold before the On command. The interval is measured from the On command until the output enters and remains within its specified accuracy band. The specification assumes that the output is fully loaded at maximum rated current.

**Input Source Impedance**

These converters will operate to specifications without external components, assuming that the source voltage has very low impedance and reasonable input voltage regulation. Since real-world voltage sources have finite impedance, performance is improved by adding external filter components. Sometimes only a small ceramic capacitor is sufficient. Since it is difficult to totally characterize all applications, some experimentation may be needed. Note that external input capacitors

must accept high speed switching currents.

Because of the switching nature of DC/DC converters, the input of these converters must be driven from a source with both low AC impedance and adequate DC input regulation. Performance will degrade with increasing input inductance. Excessive input inductance may inhibit operation. The DC input regulation specifies that the input voltage, once operating, must never degrade below the Shut-Down Threshold under all load conditions. Be sure to use adequate trace sizes and mount components close to the converter.

**I/O Filtering, Input Ripple Current and Output Noise**

All models in this converter series are tested and specified for input reflected ripple current and output noise using designated external input/output components, circuits and layout as shown in the figures below. External input capacitors (C<sub>IN</sub> in the figure) serve primarily as energy storage elements, minimizing line voltage variations caused by transient IR drops in the input conductors. Users should select input capacitors for bulk capacitance (at appropriate frequencies), low ESR and high RMS ripple current ratings. In the figure below, the C<sub>BUS</sub> and L<sub>BUS</sub> components simulate a typical DC voltage bus. Your specific system configuration may require additional considerations. Please note that the values of C<sub>IN</sub>, L<sub>BUS</sub> and C<sub>BUS</sub> will vary according to the specific converter model.

In critical applications, output ripple and noise (also referred to as periodic and random deviations or PARD) may be reduced by adding filter elements such as

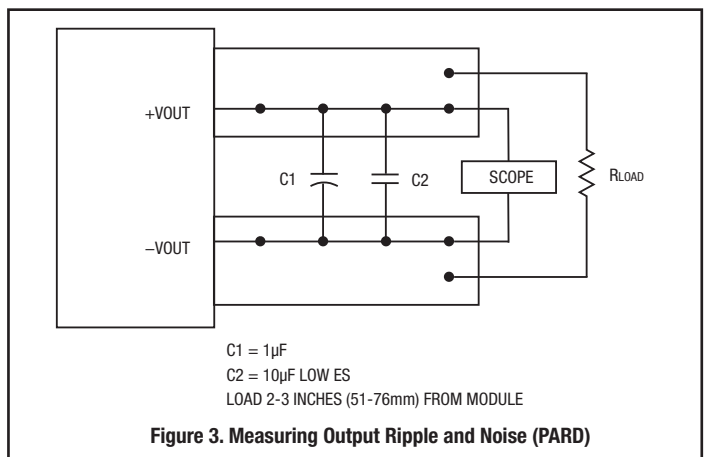
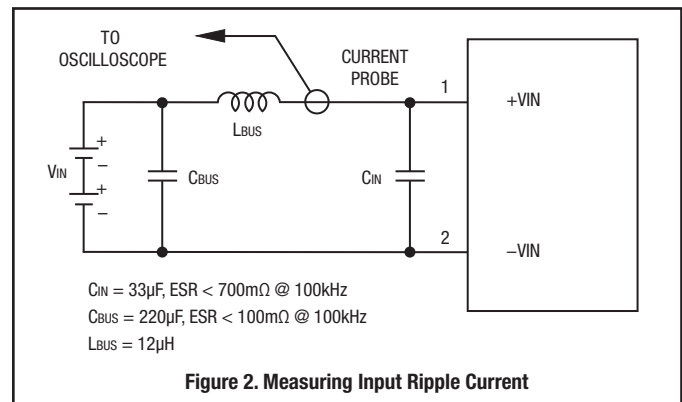

multiple external capacitors. Be sure to calculate component temperature rise from reflected AC current dissipated inside capacitor ESR.

### Floating Outputs

Since these are isolated DC/DC converters, their outputs are “floating” with respect to their input. The essential feature of such isolation is ideal ZERO CURRENT FLOW between input and output. Real-world converters however do exhibit tiny leakage currents between input and output (see Specifications). These leakages consist of both an AC stray capacitance coupling component and a DC leakage resistance. When using the isolation feature, do not allow the isolation voltage to exceed specifications. Otherwise the converter may be damaged. Designers will normally use the negative output (-Output) as the ground return of the load circuit. You can however use the positive output (+Output) as the ground return to effectively reverse the output polarity.

### Minimum Output Loading Requirements

These converters employ a synchronous rectifier design topology. All models regulate within specification and are stable under no load to full load conditions. Operation under no load might however slightly increase output ripple and noise.

### Thermal Shutdown

To protect against thermal over-stress, these converters include thermal shutdown circuitry. If environmental conditions cause the temperature of the DC/DC's to rise above the Operating Temperature Range up to the shutdown temperature, an on-board electronic temperature sensor will power down the unit. When the temperature decreases below the turn-on threshold, the converter will automatically restart. There is a small amount of hysteresis to prevent rapid on/off cycling. CAUTION: If you operate too close to the thermal limits, the converter may shut down suddenly without warning. Be sure to thoroughly test your application to avoid unplanned thermal shutdown.

### Temperature Derating Curves

The graphs in this data sheet illustrate typical operation under a variety of conditions. The Derating curves show the maximum continuous ambient air temperature and decreasing maximum output current which is acceptable under increasing forced airflow measured in Linear Feet per Minute (“LFM”). Note that these are AVERAGE measurements. The converter will accept brief increases in temperature and/or current or reduced airflow as long as the average is not exceeded.

Note that the temperatures are of the ambient airflow, not the converter itself which is obviously running at higher temperature than the outside air. Also note that “natural convection” is defined as very low rates which are not using fan-forced airflow. Depending on the application, “natural convection” is usually about 30-65 LFM but is not equal to still air (0 LFM).

Murata Power Solutions makes Characterization measurements in a closed cycle wind tunnel with calibrated airflow. We use both thermocouples and an infrared camera system to observe thermal performance. As a practical matter, it is quite difficult to insert an anemometer to precisely measure airflow in most applications. Sometimes it is possible to estimate the effective airflow if you thoroughly understand the enclosure geometry, entry/exit orifice areas and the fan flowrate specifications.

CAUTION: If you exceed these Derating guidelines, the converter may have an unplanned Over Temperature shut down. Also, these graphs are all collected near Sea Level altitude. Be sure to reduce the derating for higher altitude.

### Output Overvoltage Protection (OVP)

This converter monitors its output voltage for an over-voltage condition using an on-board electronic comparator. The signal is optically coupled to the primary side PWM controller. If the output exceeds OVP limits, the sensing circuit will power down the unit, and the output voltage will decrease. After a time-out period, the PWM will automatically attempt to restart, causing the output voltage to ramp up to its rated value. It is not necessary to power down and reset the converter for the this automatic OVP-recovery restart.

If the fault condition persists and the output voltage climbs to excessive levels, the OVP circuitry will initiate another shutdown cycle. This on/off cycling is referred to as “hiccup” mode.

### Output Fusing

The converter is extensively protected against current, voltage and temperature extremes. However, your application circuit may need additional protection. In the extremely unlikely event of output circuit failure, excessive voltage could be applied to your circuit. Consider using an appropriate external protection.

### Output Current Limiting

As soon as the output current increases to approximately its overcurrent limit, the DC/DC converter will enter a current-limiting mode. The output voltage will decrease proportionally with increases in output current, thereby maintaining a somewhat constant power output. This is commonly referred to as power limiting.

Current limiting inception is defined as the point at which full power falls below the rated tolerance. See the Performance/Functional Specifications. Note particularly that the output current may briefly rise above its rated value. This enhances reliability and continued operation of your application. If the output current is too high, the converter will enter the short circuit condition.

### Output Short Circuit Condition

When a converter is in current-limit mode, the output voltage will drop as the output current demand increases. If the output voltage drops too low, the magnetically coupled voltage used to develop PWM bias voltage will also drop, thereby shutting down the PWM controller. Following a time-out period, the PWM will restart, causing the output voltage to begin rising to its appropriate value. If the short-circuit condition persists, another shutdown cycle will initiate. This on/off cycling is called “hiccup mode.” The hiccup cycling reduces the average output current, thereby preventing excessive internal temperatures.

### Trimming the Output Voltage

The Trim input to the converter allows the user to adjust the output voltage over the rated trim range (please refer to the Specifications). In the trim equations and circuit diagrams that follow, trim adjustments use either a trimpot or a single fixed resistor connected between the Trim input and either the +Vout or -Vout terminals. (On some converters, an external user-supplied precision DC voltage may also be used for trimming). Trimming resistors should have a low temperature coefficient ( $\pm 100$  ppm/deg.C or less) and be mounted close to the converter. Keep leads short. If the trim function is not used, leave the trim unconnected. With no trim, the converter will exhibit its specified output voltage accuracy.

There are two CAUTIONs to observe for the Trim input:

CAUTION: To avoid unplanned power down cycles, do not exceed EITHER the maximum output voltage OR the maximum output power when setting the trim. Be particularly careful with a trimpot. If the output voltage is excessive, the OVP circuit

may inadvertently shut down the converter. If the maximum power is exceeded, the converter may enter current limiting. If the power is exceeded for an extended period, the converter may overheat and encounter overtemperature shut down.

**CAUTION:** Be careful of external electrical noise. The Trim input is a sensitive input to the converter's feedback control loop. Excessive electrical noise may cause instability or oscillation. Keep external connections short to the Trim input. Use shielding if needed.

**Trim Equations**

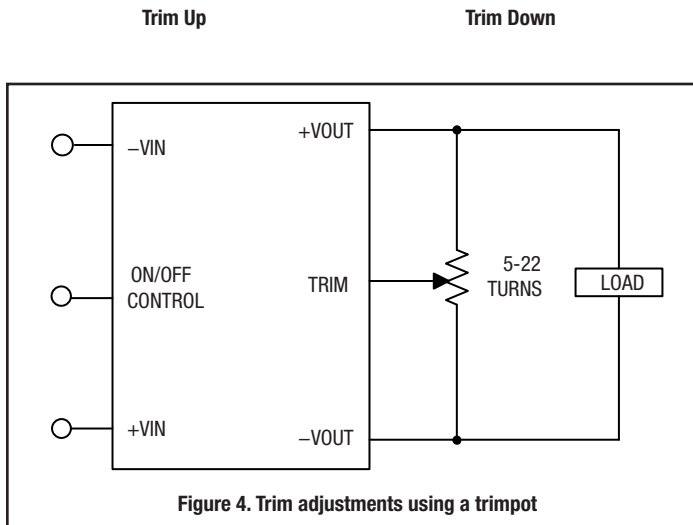

**Figure 4. Trim adjustments using a trimpot**

<Connect trim resistor between Trim and -Vout>

<Connect trim resistor between Trim and +Vout>

Where Vo = Desired output voltage. Adjustment accuracy is subject to resistor

UEI30-033-Q12/Q48	
$R_{T\_UP} (\Omega) = \frac{12775}{V_O - 3.3} - 2050$	$R_{T\_DOWN} (\Omega) = \frac{5110 (V_O - 2.5)}{3.3 - V_O} - 2050$
UEI30-050-Q12/Q48	
$R_{T\_UP} (\Omega) = \frac{12775}{V_O - 5} - 2050$	$R_{T\_DOWN} (\Omega) = \frac{5110 (V_O - 2.5)}{5 - V_O} - 2050$
UEI30-120-Q12/Q48	
$R_{T\_UP} (\Omega) = \frac{25000}{V_O - 12} - 5110$	$R_{T\_DOWN} (\Omega) = \frac{10000 (V_O - 2.5)}{12 - V_O} - 5110$
UEI30-150-Q12/Q48	
$R_{T\_UP} (\Omega) = \frac{25000}{V_O - 15} - 5110$	$R_{T\_DOWN} (\Omega) = \frac{10000 (V_O - 2.5)}{15 - V_O} - 5110$

tolerances and factory-adjusted output accuracy. Mount trim resistor close to converter. Use short leads.

**Remote On/Off Control**

On the input side, a remote On/Off Control can be specified with either positive or negative logic as follows:

**Positive:** Models equipped with Positive Logic are enabled when the On/Off pin is left open or is pulled high to +VIN with respect to -VIN. An internal bias current causes the open pin to rise to +VIN. Some models will also turn on at lower intermediate voltages (see Specifications). Positive-logic devices are disabled when the On/Off is grounded or brought to within a low voltage (see Specifications) with respect to -VIN.

**Negative:** Models with negative logic are on (enabled) when the On/Off is grounded or brought to within a low voltage (see Specifications) with respect to -VIN. The device is off (disabled) when the On/Off is left open or is pulled high to +15VDC Max. with respect to -VIN.

Dynamic control of the On/Off function should be able to sink the specified signal current when brought low and withstand appropriate voltage when brought high. Be aware too that there is a finite time in milliseconds (see Specifications) between the time of On/Off Control activation and stable, regulated output. This time will vary slightly with output load type and current and input conditions.

There are two CAUTIONs for the On/Off Control:

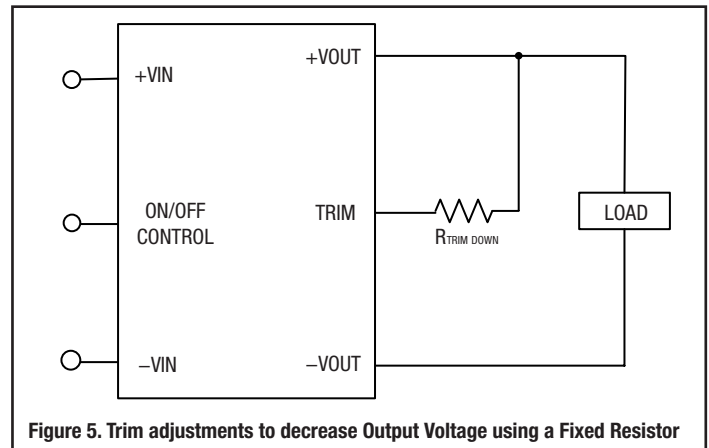

**Figure 5. Trim adjustments to decrease Output Voltage using a Fixed Resistor**

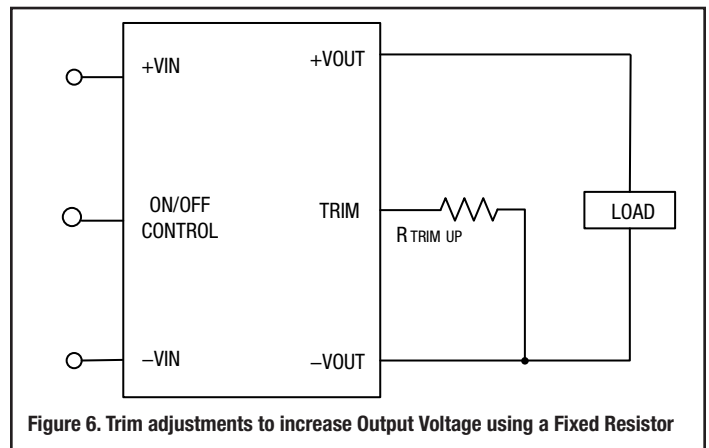

**Figure 6. Trim adjustments to increase Output Voltage using a Fixed Resistor**

**CAUTION:** While it is possible to control the On/Off with external logic if you carefully observe the voltage levels, the preferred circuit is either an open drain/ open collector transistor or a relay (which can thereupon be controlled by logic). The On/Off prefers to be set at approx. +15V (open pin) for the ON state, assuming positive logic.

**CAUTION:** Do not apply voltages to the On/Off pin when there is no input power voltage. Otherwise the converter may be permanently damaged.

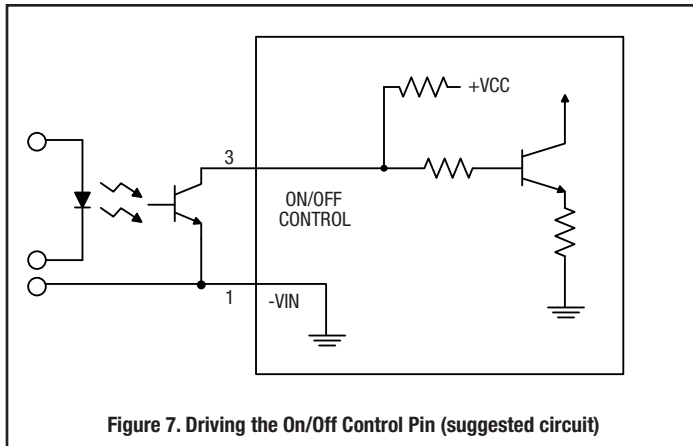

Figure 7. Driving the On/Off Control Pin (suggested circuit)

**Pre-Bias Protection**

Pre-Bias Protection For applications where a pre-bias potential can be present at the output of the power module it is recommended that either blocking diodes are added in series with the Vout power lines or, a preferred solution is to use an OR-ing FET controller like the LM5050-1 High-Side & LM5051 Low-Side OR-ing FET Controller from TI. Starting the module into a pre-bias condition can cause permanent damage to the module.

**Emissions Performance**

Murata Power Solutions measures its products for radio frequency emissions against the EN 55022 and CISPR 22 standards. Passive resistance loads are employed and the output is set to the maximum voltage. If you set up your own emissions testing, make sure the output load is rated at continuous power while doing the tests.

The recommended external input and output capacitors (if required) are included. Please refer to the fundamental switching frequency. All of this information is listed in the Product Specifications. An external discrete filter is installed and the circuit diagram is shown below.

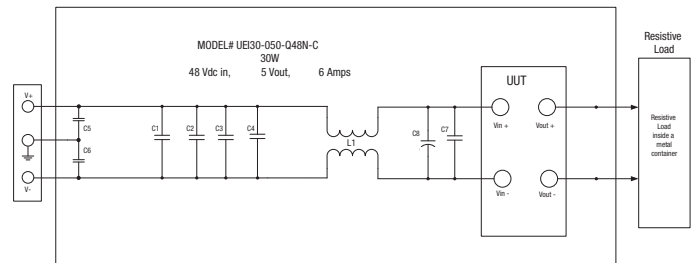

Figure 8. Conducted Emissions Test Circuit

**[1] Conducted Emissions Parts List**

Reference	Description
L1	500µH, 4.1A
C8	Electrolytic Capacitor 100µfd, 100V
C1, C2, C3 C4, C5, C6, C7	3.3µfd, 50V

**[2] Conducted Emissions Test Equipment Used**

- Rohde & Schwarz EMI Test Receiver (9KHz – 1000MHz) ESPC
- Rohde & Schwarz Software ESPC-1 Ver. 2.20
- OHMITE 25W – 1 Ohm resistor combinations
- DC Source Programmable DC Power Supply Model 62012P-100-50

**[3] Conducted Emissions Test Results**

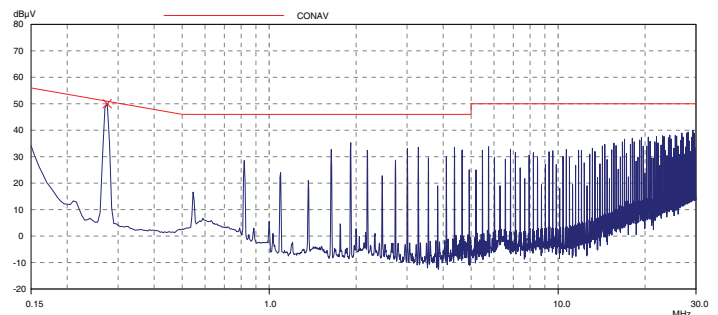

Graph 1. Conducted emissions performance with filter, Negative Line, CISPR 22, Class B, full load, for UEI30-033-Q48N-C



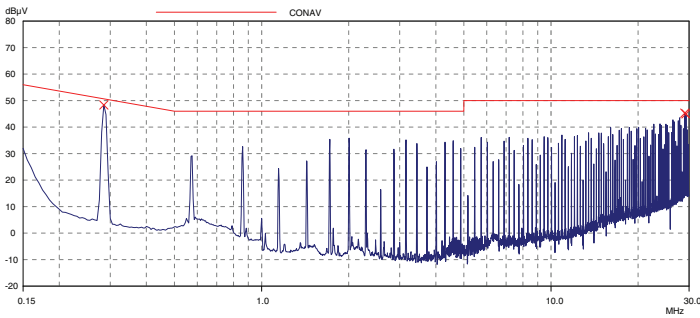

**Graph 2. Conducted emissions performance with filter, Negative Line, CISPR 22, Class B, 5.43A @ 48Vin, for UEI30-050-Q48N-C**

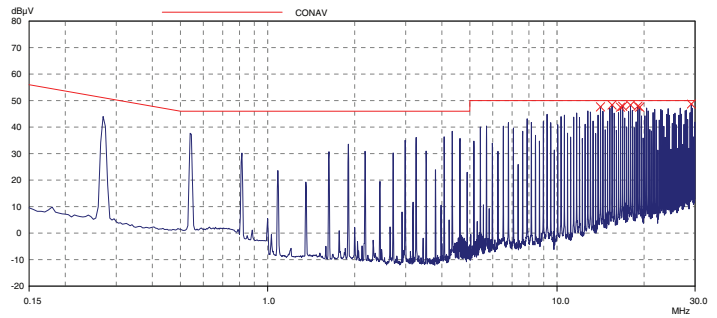

**Graph 5. Conducted emissions performance with filter, Negative Line, CISPR 22, Class B, full load, for UEI30-150-Q12N-C**

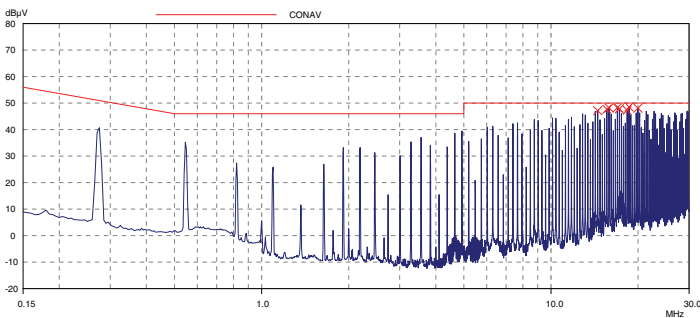

**Graph 3. Conducted emissions performance with filter, Negative Line, CISPR 22, Class B, full load, for UEI30-120-Q12N-C**

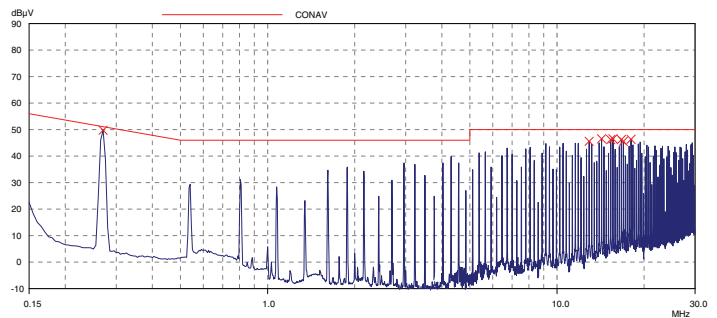

**Graph 6. Conducted emissions performance with filter, Negative Line, CISPR 22, Class B, full load, for UEI30-150-Q48N-C**

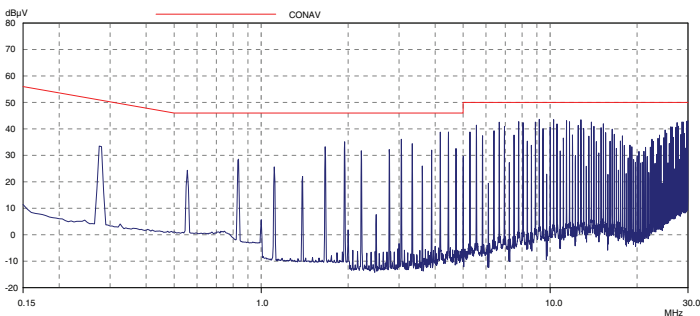

**Graph 4. Conducted emissions performance with filter, Negative Line, CISPR 22, Class B, full load, for UEI30-120-Q48N-C**

**[4] Layout Recommendations**

Most applications can use the filtering which is already installed inside the converter or with the addition of the recommended external capacitors. For greater emissions suppression, consider additional filter components and/or shielding. Emissions performance will depend on the user's PC board layout, the chassis shielding environment and choice of external components.

Since many factors affect both the amplitude and spectra of emissions, we recommend using an engineer who is experienced at emissions suppression.

### Mean Time Before Failure (MTBF) Table

These figures use a standard MTBF probability calculation as an indication of component parts stress and life derating. The calculation is based on separate MTBF values for all internal parts in addition to stated environmental conditions. Two MTBF values are presented. The Telcordia method is widely used in industry, particularly telecom. The United States MIL-HDBK method is for military and industrial applications. Please refer to a qualified reliability engineer for more background.

Model Number	MTBF (Hours)	Method [1,2]
UEI30-033-Q12N-C	2,676,902	Telcordia
UEI30-033-Q12N-C	2,123,124	MIL-HDBK
UEI30-033-Q12P-C	2,733,781	Telcordia
UEI30-033-Q12P-C	2,142,206	MIL-HDBK
<b>UEI30-033-Q48N-C</b>		
UEI30-033-Q48N-C	3,416,592	Telcordia
UEI30-033-Q48N-C	3,172,548	MIL-HDBK
UEI30-033-Q48P-C	3,427,027	Telcordia
UEI30-033-Q48P-C	3,193,652	MIL-HDBK
<b>UEI30-050-Q12N-C</b>		
UEI30-050-Q12N-C	2,531,509	Telcordia
UEI30-050-Q12N-C	2,207,508	MIL-HDBK
UEI30-050-Q12P-C	2,554,127	Telcordia
UEI30-050-Q12P-C	2,229,031	MIL-HDBK
<b>UEI30-120-Q48N-C</b>		
UEI30-120-Q48N-C	3,072,461	Telcordia
UEI30-120-Q48N-C	2,510,927	MIL-HDBK
UEI30-120-Q48P-C	2,900,319	Telcordia
UEI30-120-Q48P-C	2,495,846	MIL-HDBK
<b>UEI30-150-Q48N-C</b>		
UEI30-150-Q48N-C	2,833,366	Telcordia
UEI30-150-Q48N-C	2,408,836	MIL-HDBK
UEI30-150-Q48P-C	2,776,615	Telcordia
UEI30-150-Q48P-C	2,421,938	MIL-HDBK

**Notes:**

[1] Mean Time Before Failure is calculated using the Telcordia (Belcore) SR-332 Method 1, Case 3, ISSUE 2, ground fixed controlled conditions, Tambient=+25°C, full output load, natural air convection.

[2] Mean Time Before Failure is calculated using MIL-HDBK-217FN2, GB ground benign, Tambient=+25°C, full output load, natural air convection.

### Soldering Guidelines

Murata Power Solutions recommends the specifications below when installing these converters. These specifications vary depending on the solder type. Exceeding these specifications may cause damage to the product. Your production environment may differ; therefore please thoroughly review these guidelines with your process engineers.

Wave Solder Operations for through-hole mounted products (THMT)			
For Sn/Ag/Cu based solders:		For Sn/Pb based solders:	
Maximum Preheat Temperature	115° C.	Maximum Preheat Temperature	105° C.
Maximum Pot Temperature	270° C.	Maximum Pot Temperature	250° C.
Maximum Solder Dwell Time	7 seconds	Maximum Solder Dwell Time	6 seconds

Murata Power Solutions, Inc.  
ISO 9001 and 14001 REGISTERED



**This product is subject to the following operating requirements and the Life and Safety Critical Application Sales Policy:  
Refer to: <https://www.murata-ps.com/requirements/>**

Murata Power Solutions, Inc. makes no representation that the use of its products in the circuits described herein, or the use of other technical information contained herein, will not infringe upon existing or future patent rights. The descriptions contained herein do not imply the granting of licenses to make, use, or sell equipment constructed in accordance therewith. Specifications are subject to change without notice.

© 2021 Murata Power Solutions, Inc.