

GP100H3R48TEZ Global Platform Line High Efficiency Rectifier

3 Φ -380/480V_{AC} input; Default Output: \pm 52/48V_{DC} @ 6000W



RoHS Compliant

The GP100H3R48TEZ series of rectifiers provide significant efficiency improvements in the Global Platform of Power supplies. High-density front-to-back airflow is designed for minimal space utilization and is highly expandable for future growth. The 3 Φ - 380/480V_{rms} input product is designed to be deployed internationally. It is configured with an isolated RS485 compliant communications bus that allows it to be used in a broad range of applications. Feature set flexibility makes these rectifiers an excellent choice for applications requiring modular, very-high-efficiency AC to - 52V_{DC} intermediate voltages, such as in distributed power.

Applications

- 48V_{DC} distributed power architectures
- Routers/ VoIP/Soft and other Telecom Switches
- LAN/WAN/MAN applications
- File servers, Enterprise Networks, Indoor wireless
- SAN/NAS/iSCSI applications

Features

- Efficiency 96.5% typical, exceeds 80plus Titanium levels
- Compact 1RU form factor with 30 W/in³ density
- Constant power from 48 – 58V_{DC}
- 6000W from nominal 3 Φ -380/480V_{AC}
- Isolated RS485 based serial bus
- Power factor correction (meets EN/IEC 61000-3-2 and EN 60555-2 requirements)
- Output overvoltage and overload protection
- AC Input overvoltage and undervoltage protection
- Over-temperature warning and protection
- Redundant, parallel operation with active load sharing
- Internally controlled Variable-speed fan
- Hot insertion/removal (hot plug)
- Three front panel LED indicators
- EN/IEC/UL/CSA C22.2 62368-1 2nd edition +A1
- CE mark⁵
- Meets FCC part 15, EN55032 Class A standards
- Meets EN61000 immunity and transient standards
- Shock & vibration: Meets IPC 9592 Class II standards

Technical Specifications

Absolute Maximum Ratings

Stresses in excess of the absolute maximum ratings can cause permanent damage to the device. These are absolute stress ratings only, functional operation of the device is not implied at these or any other conditions in excess of those given in the operations sections of the data sheet. Exposure to absolute maximum ratings for extended periods can adversely affect the device reliability.

Parameter	Symbol	Min	Max	Unit
Input Voltage: Continuous	V_{IN}	0	600	V_{AC}
Operating Ambient Temperature ¹	T_A	-10	75	°C
Storage Temperature	T_{stg}	-40	85	°C
I/O Isolation voltage to Frame (100% factory Hi-Pot tested)			2087	V_{AC}

Electrical Specifications

Unless otherwise indicated, specifications apply over all operating input voltage, $V_o=52V_{DC}$, resistive load, and temperature conditions. To meet measurement accuracy a warm up time of 1hr may be required.

INPUT

Parameter	Symbol	Min	Typ	Max	Unit
Operating Voltage Range (3Φ delta with safety frame ground)	V_{IN}	320	380/480	530	V_{AC}
Low voltage	Turn-OFF V_{IN} Turn-ON Hysteresis	(300)		320	
		(315)		330	
		5			
High voltage	Turn-OFF V_{IN} Turn-ON Hysteresis	530		(550)	
		520		(540)	
		5			
Input voltage phase unbalance	V_{IN}	-15		10	%
Frequency	F_{IN}	47		63	Hz
Operating Current (3Φ - all phases operational)	I_{IN}			15	A_{AC}
Input current phase unbalance (at 480V _{AC})				1.5	%
Inrush Transient (per Φ at 480V _{RMS} , 25°C, excluding X-Capacitor charging)	I_{IN}		25	30	A_{PK}
Source Impedance (NEC allows 2.5% of source voltage drop inside a building)		0.20	0.25		Ω
Idle Power (at 480V _{AC} , 25°C)	Main output OFF	P_{IN}	25		W
	Main output ON @ $I_o=0$		45		
Leakage Current (per Φ, 530V _{AC} , 60Hz)	I_{IN}		2.5	3.5	mA
Power Factor (50 – 100% load)	PF	0.96	0.995		
Efficiency (380/480V _{AC} @ 25°C)	10% load	η		88.1 to 90.8%	%
	20% load			92.2 to 94.2%	
	50% load			95.6 to 96.2%	
	100% load			94.9% to 95.8%	
Holdup time ($V_{in} = 320V_{rms}$, $V_{out} \geq 42V_{DC}$, constant power load)	T	10	12		ms
Ride through (at 480V _{AC} , 25°C, constant power load)	T	1/2	1		cycle
Isolation (per EN62368)	Input – Output	V	3000		V_{AC}
	Input-Chassis/Signals		2000		V_{AC}

See footnotes on page 9

Technical Specifications (continued)

52V_{DC} MAIN OUTPUT

Parameter	Symbol	Min	Typ	Max	Unit		
Output Power (320 – 530V _{AC} – 3Φ)	W	6000			W _{DC}		
GP100H3R48TEZ Factory set default set point V _{IN} = 480V, I = 10% FL, 25°C (droop regulation; max-no load, min-full load)	V _{OUT}	-320	52	600	V _{DC} mV _{DC}		
GP100H3R48TEZ - IN Factory set default set point V _{IN} = 480V, I = 10% FL, 25°C (droop regulation; max-no load, min-full load)		-320	48	600	V _{DC} mV _{DC}		
Overall regulation (load, temperature, aging) Corrected for droop Or < 1% when not correct for droop		-0.5		0.5	%		
		-2		2	%		
Output Current (T _{AMB} = 55°C)	I _{OUT}	V _{OUT} = 52V _{DC} 1		115	A _{DC}		
		V _{OUT} = 48V _{DC} 1		125			
Current Share (> 50% FL) remotely controlled I _{SHARE} is employed		-2		2	%FL		
Output Ripple RMS (5Hz to 20MHz)	V _{OUT}			100	mV _{rms}		
20MHz bandwidth Peak-to-Peak (5Hz to 20MHz)				250	mV _{p-p}		
Voice Band Output Noise	V _{OUT}	With 880Ahr battery in system		45	dBrnC		
		Without battery		55			
External Bulk Load Capacitance	C _{OUT}	0		1,700	μF/A		
Turn-On (monotonic turn-ON from 30 – 100% of V _{nom} , above -10°C ²)	T				s		
Rise Time – RS-485 mode						55A (50% load)	2.5
						83A (75% load)	5
						100A (90% load)	8
Output Overshoot	V _{OUT}			2	%		
Load Step Response	I _{OUT}			60	%FL		
ΔI [V _{IN} = 380/480V _{AC} , 25°C, load step 10% ↔ 90%, di/dt = 1A/μs]	V _{OUT}	-5		5	%		
ΔV, (380/480 V _{AC} , 25°C)	T			20	ms		
Settling Time to normal regulation							
Overload ³ - Power limit when V _{OUT} ≥ 48V _{DC} recoverable current limit when 40V _{DC} < V _{OUT} < 48V _{DC} Output shutdown (one retry after a 2 – 10 second delay) Short circuit protection System power up	P _{OUT}	6050			W _{DC}		
	I _{OUT}	110		120	%FL		
	V _{OUT}			36	V _{DC}		
	No damage Upon startup, delay overload shutdown for 20 seconds to allow the insertion and startup of multiple modules within a system.						
Overvoltage	V _{OUT}	200ms delayed shutdown(default)	59	59.5	60	V _{DC}	
		Immediate shutdown	> 65				
		Programmable range	44		59.5		
	Latched shutdown	If 3 restart attempted within a 30 sec window unit latches OFF					
Restart delay		3.5	4	5	sec		
Over-temperature warning (prior to commencement of shutdown)	T			5	°C		
Shutdown (below the max device rating being protected)				20			
Restart attempt Hysteresis (below shutdown level)				10			
Isolation Output-Chassis	V	500			V _{DC}		
Restart/Reset conditions	Loss of input > 100ms or Output OFF followed by ON command						

See footnotes on page 9

Technical Specifications (continued)

General Specifications

Parameter		Min	Typ	Max	Units	Notes
Reliability	Calculated		560,000 190,000		Hours	Full load, 25°C ; Full load, 55°C ; - MTBF per Telecordia SR232 Reliability protection for electronic equipment,
Service Life			10		Years	80% load, 35°C ambient, excluding fans
Unpacked Weight			9.4/4.3		lb/kg	
Packed Weight			10.2/4.6		lb/kg	
Heat Dissipation		200 Watts or 682 BTUs @ 80% load, 250 Watts or 853 BTUs @ 100% load				

Signal Specifications

Unless otherwise indicated, specifications apply over all operating input voltage, resistive load, and temperature conditions. Signals are referenced to Logic_GND unless noted otherwise. See the Signal Definitions table for additional information.

Parameter	Symbol	Min	Typ	Max	Unit
Interlock [Connected externally, referenced to Vout (-)] Normal operation	V	0		3.3	V _{DC}
Interlock2 [Connected externally to Logic_GND] Normal operation	V	—		0.4	V _{DC}
Module Present [Internally shorted to Logic_GND] Normal operation	V	—		0.4	V _{DC}
8V_INT (no components should be connected to this pin) Interconnected between power supplies to back-bias the internal secondary processor					

Digital Interface Specifications

Parameter	Conditions	Symbol	Min	Typ	Max	Unit
RS485 Isolation from the main output					60	V _{DC}
Standard measurement parameters	Update frequency				1	Hz
	Report delay after 25% step				2	sec
	Report delay to accuracy				10	sec
I _{OUT} measurement range		I _{MR}	0		130	A _{DC}
I _{OUT} measurement accuracy 25°C	> 25A	I _{OUT(ACC)}	-1		1	% of FL
	< 25A		-2.5		2.5	%
V _{OUT} measurement range		V _{OUT(rMR)}	0		70	V _{DC}
V _{OUT} measurement accuracy		V _{OUT(ACC)}	-1		1	%
P _{OUT} measurement range		P _{OUT(rMR)}	0		6100	W _{DC}
P _{OUT} measurement accuracy		P _{OUT(ACC)}	-1		1	%
Temp measurement range		Temp _(rMG)	0		150	°C
V _{IN} measurement range, each phase		V _{IN(rMG)}	0		600	V _{AC}
V _{IN} measurement accuracy		V _{IN(ACC)}	-1.5		1.5	%

Technical Specifications (continued)

Parameter	Conditions	Symbol	Min	Typ	Max	Unit
I _{IN} measurement range, each phase		I _{IN(MR)}	0		20	A _{DC}
I _{IN} measurement accuracy		I _{IN(ACC)}	-3		3	% of FL
P _{IN} measurement range, computed 3Φ result		P _{in(rng)}	0		6750	W _{in}
P _{IN} measurement accuracy	> 500W	P _{in(acc)}	-150		150	W

Environmental Specifications

Parameter		Min	Typ	Max	Units	Notes
Ambient Temperature		-10 ⁴		55	°C	Air inlet from sea level to 5,000 feet.
Storage Temperature		-40		85	°C	
Operating Altitude				1524/5000	m / ft	
Non-operating Altitude				8200/30k	m / ft	
Power Derating with Temperature				2.0	%/°C	55°C to 75°C ⁵
Power Derating with Altitude				2.0	°C/305 m °C/1000 ft	Above 1524/5000 m/ft; 3962/13000 m/ft max
Humidity	Operating	5		95	%	Relative humidity, non-condensing
	Storage	5		95	%	
Shock and Vibration	Operational	Meets IPC 9592 Class II, Section 5 and GR-63_CORE requirements				
Acoustic Noise			55	58	dBA	
Earthquake Rating		4			Zone	Meet GR-63_CORE requirements
Insulation Resistance						

Technical Specifications (continued)

EMC

[Surges and sags applied one Φ at a time and all 3Φ 's simultaneously; phase angles 0, 90, 270°]

Parameter	Function	Standard	Level	Criteria	Test	
AC input	Conducted emissions	EN55032, FCC part 15 EN61000-3-2 Telcordia GR1089-CORE	A – 6dB margin		0.15 – 30MHz 0 – 2 KHz	
	Radiated emissions	EN55032	A – 6dB margin		30 – 10000MHz	
AC Input Immunity	Line sags and interruptions	EN61000-4-11 Output will stay above 40V _{DC} @ full load SEMI-F47 Compliant at 480 Vac	0% Sag	A	1/2 cycle	
			0% Sag	A	1 cycle	
			40% Sag	A	10/12 cycles	
			70% Sag	B	25/30 cycles	
			80% Sag	B	250/300 cycles	
			0% Sag	B	250/300 cycles	
	Lightning surge	EN61000-4-5, Level 4, 1.2/50 μ s – error free ANSI C62.41-2002 100kHz ring wave 1.2/50 μ s-8/20 μ s 550ns EFT burst			A	4kV, comm
					A	2kV, diff
			3, Category B	B	6kV/0.5kA	
			3, Category B	B	6kV, 3kA	
			B	2kV, severity II		
Fast transients	EN61000-4-4	3	A	5/50ns, 2kV (common mode)		
Enclosure immunity	Conducted RF fields	EN61000-4-6	3	A	10Vrms, 0.15-80MHz, 80% AM	
	Radiated RF fields	EN61000-4-3	3	A	10V/m, 80-1000MHz, 80% AM	
		ENV 50140		A		
	ESD	EN61000-4-2	4	A	8kV contact, 15kV air	

Criteria Performance

- A No performance degradation
- B Temporary loss of function or degradation not requiring manual intervention
- C Temporary loss of function or degradation that may require manual intervention
- D Loss of function with possible permanent damage

Technical Specifications (continued)

Timing diagrams

Response to input fluctuations

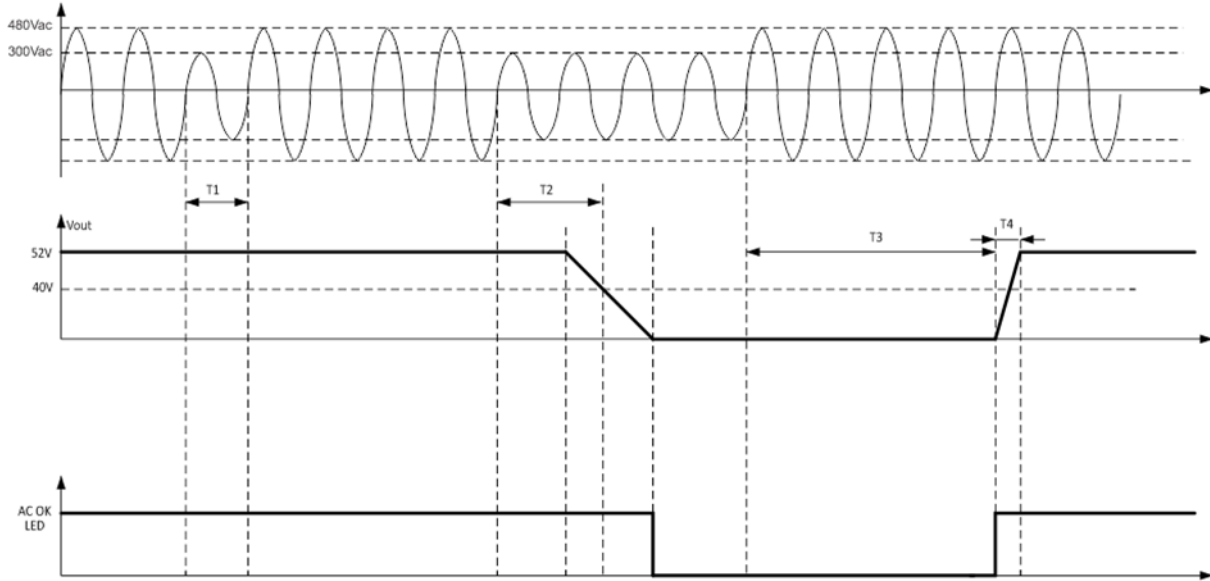

T_1 – ride through time – 0.5 to 1 cycles [10 – 20ms] V_{OUT} remains within regulation – load dependent

T_2 – hold up time - 15ms – V_{OUT} stays above 40V_{DC}

T_3 – delay time – <5s – from when the AC returns within regulation to when the output starts rising

T_4 – rise time – varies according to output loading, up to 8 seconds at full load

Technical Specifications (continued)

Control and Status

This Rectifier incorporates the OmniOn Galaxy, RS485 based, protocol. OmniOn will provide separate documentation on the Galaxy RS485 based protocol for users desiring to interface to the rectifier. Contact your local OmniOn representative for details.

Control Signals

Bay_ID⁶: Up to 10 different units are selectable.

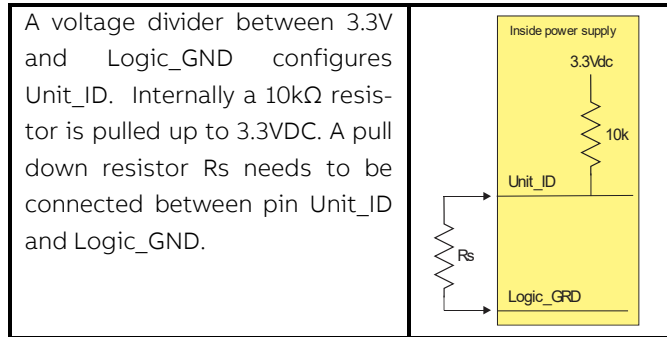

Bay_ID	Voltage level	R_s ($\pm 0.1\%$)
Invalid	3.30	
1	3.00	100k
2	2.67	45.3k
3	2.34	24.9k
4	2.01	15.4k
5	1.68	10.5k
6	1.35	7.15k
7	1.02	4.99k
8	0.69	2.49k
9	0.36	1.27k
10	0	0

Device address in RS485 mode: The address in RS485 mode is divided into two components; Slot_ID and Shelf_ID

Slot_ID: Up to 10 different modules could be positioned across a 19" shelf if the modules are located vertically within the shelf. The resistor below needs to be placed between Slot_ID and Vout (-). Internal pull-up to 3.3V is

Slot	Resistor	Voltage	Slot	Resistor	Voltage
invalid	none	3.3V	6	7.15k	1.35V
1	100k	3V	7	4.99k	1.02V
2	45.3k	2.67V	8	2.49k	0.69V
3	24.9k	2.34V	9	1.27k	0.36V
4	15.4k	2.01V	10	0	0
5	10.5k	1.68V			

10kΩ.

See footnotes on page 9

Page 8

© 2023 OmniOn power Inc. All rights reserved.

Shelf_ID: When placed horizontally up to 20 shelves can be stacked on top of each other in a fully configured rack. The shelf will generate the precision voltage level tabulated below referenced to Vout (-).

Shelf	V_{MIN}	V_{NOM}	V_{MAX}
Fault	0	0	0
1	1.21	1.23	1.24
2	2.42	2.45	2.48
3	3.63	3.68	3.72
4	4.84	4.90	4.96
5	6.06	6.13	6.20
6	7.27	7.35	7.43
7	8.48	8.58	8.67
8	9.69	9.80	9.91
9	10.90	11.03	11.15
10	12.11	12.25	12.39
11	13.32	13.48	13.63
12	14.53	14.70	14.87
13	15.74	15.93	16.11
14	16.95	17.15	17.35
15	18.17	18.38	18.59
16	19.38	19.60	19.82
17	20.59	20.83	21.06
18	21.80	22.05	22.30
19	23.01	23.28	23.54
20	24.22	24.50	24.78

Interlock⁷/Interlock²: This is a short pin utilized for hot -plug applications to ensure that the rectifier turns **OFF** before the power pins are disengaged. It also ensures that the rectifier turns **ON** only after the power pins have been engaged. Must be connected to V_OUT (-) for the rectifier to be ON.

8V_INT: Single wire connection between modules, provides redundant bias to the DC/DC control circuitry of an unpowered module.

LEDs

Three LEDs are located on the front faceplate. The AC_OK LED provides visual indication of the INPUT signal function. When the LED is ON GREEN the rectifier input is within normal design limits.

The second LED is the DC_OK LED. When GREEN the DC output is present. When 'blinking' a power limit or overload condition exists. When OFF the output is not present.

The third LED is the FAULT LED. A continuous RED condition indicates a fault. Blinking of the RED LED indicates loss of communications.

Technical Specifications (continued)

Table 2: Alarm and LED state summary

Condition	Rectifier LED State			Monitoring Signals ¹⁰		
	AC OK Green	DC OK Green	Fault Red	Fault	Module Present	
OK	1	1	0	HI		LO
Thermal Alarm (5°C before shutdown)	1	1	Blinks	HI		LO
Thermal Shutdown	1	0	1	LO		LO
Defective Fan	1	0	1	LO		LO
Blown AC Fuse in Unit	1	0	1	LO		LO
AC Present but not within limits	Blinks	0	0	HI		LO
AC not present ⁸	0	0	0	HI		LO
Boost Stage Failure	1	0	1	LO		LO
Over Voltage Latched Shutdown	1	0	1	LO		LO
Over Current	1	Blinks	0	HI		LO
Non-catastrophic Internal Failure ⁹	1	1	1	LO		LO
Missing Module						HI

Table 3: Signal Definitions

Signals are referenced to Logic_GND unless otherwise stated.

Function	Label	Type	Description
Module Present	MOD_PRES	Output	Short pin, Connected to Logic_GND notifies the system that module is present,
Slot Address/ Interlock	Slot_ID INTERLOCK	Input	Short pin referenced to Vout(-) . This signal provides the last-to-make and first-to-break function to properly control the rectifier for hot plug and hot disengagement. A voltage level identifies the rectifier slot address in a shelf.
Shelf Address	Shelf_ID	Input	A voltage level referenced to Vout (-) identifies the shelf address
Bay Address	Bay_ID	Input	
DC-DC Back bias	8V_INT	Bi-direct	Used to back bias the DSP from other operating Power supplies. Ref: Vout (-).
Interlock2	INTERLOCK2	Input	A short pin referenced to Logic_GND. This signal provides a second interlocking feature of last-to-make and first-to-break function to properly control the rectifier for hot plug insertion and disengagement.

*UL is a registered trademark of Underwriters Laboratories, Inc.

†CSA is a registered trademark of Canadian Standards Association.

§This product is intended for integration into end-user equipment. All CE marking procedures of end-user equipment should be followed. (The CE mark is placed on selected products.)

**ISO is a registered trademark of the International Organization of Standards

¹ See the derating guidelines under the Environmental Specifications section

² Below -5°C, the rise time is approximately 5 minutes to protect the bulk capacitors.

³ Overload retries must incorporate normal soft-start turn-ON.

⁴ Designed to start and work at an ambient as low as -40°C, but may not meet operational limits until above -10°C

⁵ The maximum operational ambient is reduced in Europe in order to meet certain power cord maximum ratings of 70°C. The maximum operational ambient where 70°C rated power cords are utilized is reduced to 60°C until testing demonstrates that a higher level is acceptable.

⁶ Bay_ID and Unit_ID are the same signals.

⁷ Dual functionality of Slot_ID and Interlock

⁸ This signal is correct if the rectifier is back biased from other power supplies in the shelf.

⁹ Any detectable fault condition that does not cause a shutting down. For example, ORing FET failure, boost section out of regulation, etc.

¹⁰ Signal transition from HI to LO is output load dependent.

Technical Specifications (continued)

Mechanical Outline

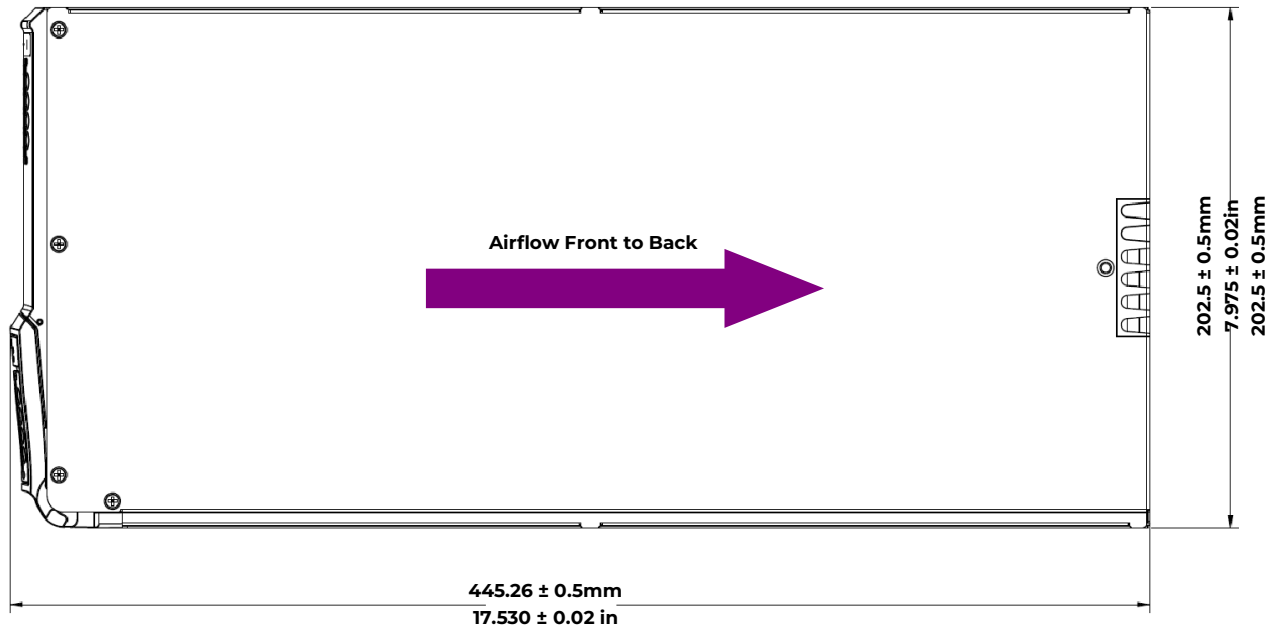

Top View

[Note: add safety label to side of unit per UL, EC directives, TUV, Power Systems Practices]

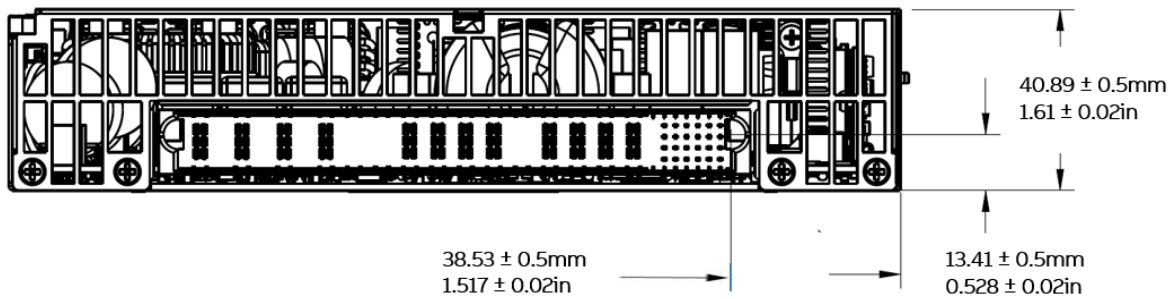

Rear View

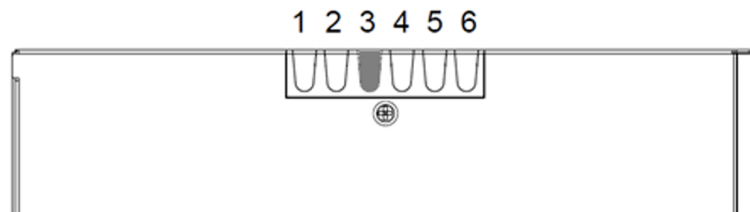

Keying

Product	Keying Location Knotted
GP communications	3

Technical Specifications (continued)



Front View: Faceplate Color: Spattered Finish CO White (OS11148)

Front Panel LEDs

Symbol	Color	Function
~	Green	ON: Input ok Blinking: Input out of limits
!	Red	ON: Fault Blinking: loss of communications
≡	Green	ON: Output ok Blinking: Overload

Mating Connector

Rectifier side: Tyco 3-6450832-6

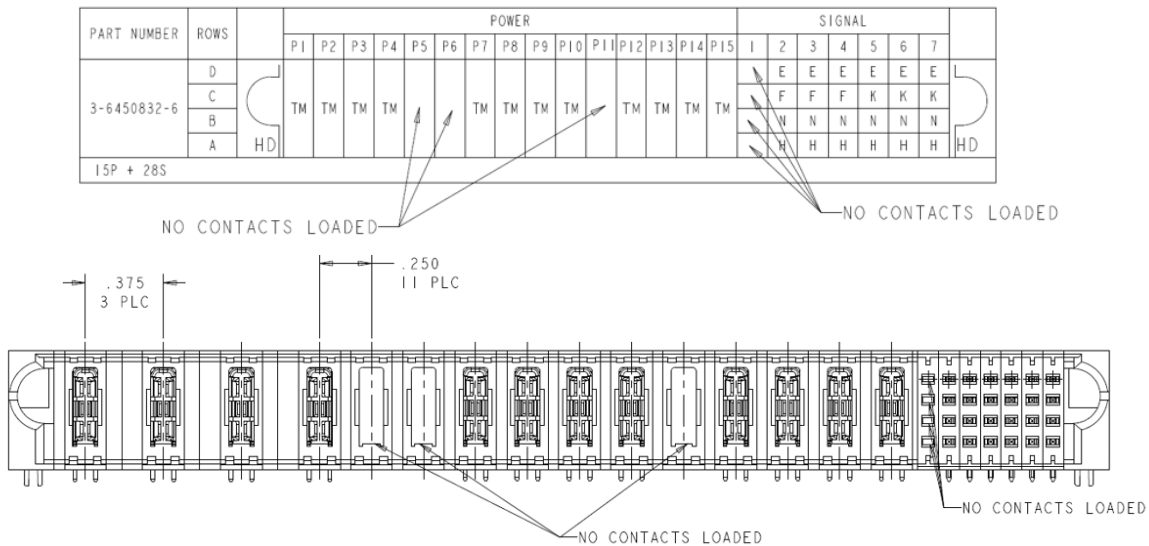

AC INPUT				DC OUTPUT											SIGNALS						
P1	P2	P3	P4	P5	P6	P7	P8	P9	P10	P11	P12	P13	P14	P15	1	2	3	4	5	6	7
L1	L2	L3	Frame Gnd	Empty	Empty	Vout +	Vout +	Vout +	Vout +	Empty	Vout -	Vout -	Vout -	Vout -	Empty	SLOT_ID INTERLOCK	Boy_ID	RS485-	RS485+	D	
															Empty	SHELF_ID		MOD_PRES		LOGIC_GND	C
															Empty	8V_INT					B
															Empty		INTERLOCK2				A

Notes:
 = Short Pin
 = System side mating connector must have its Frame GRD pin the longest to ensure that it is mating first.
 = Slot location

Pin out as looking straight at the connector

SIGNALS						
1	2	3	4	5	6	7
Empty	SLOT_ID INTERLOCK		Boy_ID		RS485-	RS485+
Empty	SHELF_ID			MOD_PRES		LOGIC_GND
Empty	8V_INT					
Empty			INTERLOCK2			

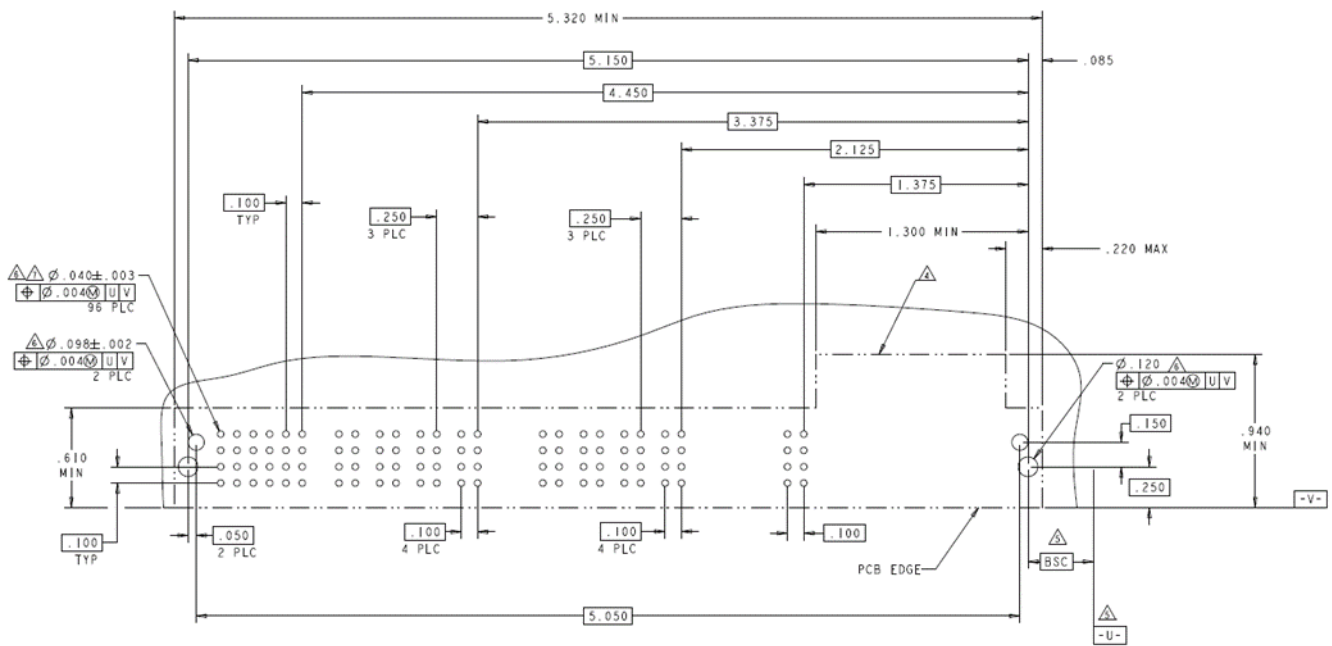
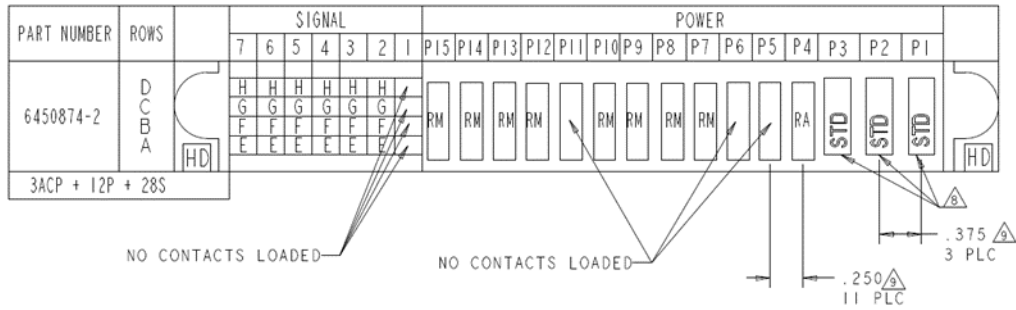

System side receptacle:

Tyco soldered version: 6450874-2
 press-fit version: 6450884-2
 AC power contact: 1-1600961-8 (3X)
 AC power contact secondary lock: 1600903-1 (3X)

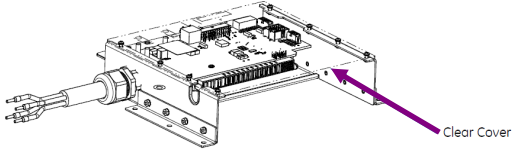

RECOMMENDED PCB LAYOUT

Accessories

Item	Description	Part number
	<p>1u_GP100_interface: Rectifier interface board. This debug tool can be used to evaluate the performance of the rectifier. The input interface is a set of 4 wires, 3 -phases and a frame ground connection. The output is a set of DC lug landings. See the installation guide for further information.</p>	150044268
	1u_GP100_interface Installation Guide	850048307
	<p>Designed to mount into standard 19" EIA-310-D racks, these GE shelves provide a turn-key solution for customers. The selection guide is documented on the OmniOn website.</p>	See OmniOn website

Ordering Information

Please contact your OmniOn Sales Representative for pricing, availability and optional features

Item	Description	Ordering code
GP100H3R48TEZ	110A rectifier with isolated RS485 communications, 52.5Vdc default	150034309
GP100H3R48TEZ-IN	110A rectifier with isolated RS485 communications, 48Vdc default	150045497

Change History (excludes grammar & clarifications)

Revision	Date	Description of the change
3.2	01-05-2022	Updated as per template and upgraded safety standards
3.3	10-25-2022	Removed obsolete GP100H3R48TEZ-CO
3.4	11-20-2023	Updated as per OmniOn template

OmniOn Power Inc.

601 Shiloh Rd.
Plano, TX USA

omnionpower.com

We reserve the right to make technical changes or modify the contents of this document without prior notice. OmniOn Power does not accept any responsibility for errors or lack of information in this document and makes no warranty with respect to and assumes no liability as a result of any use of information in this document.

We reserve all rights in this document and in the subject matter and illustrations contained therein. Any reproduction, disclosure to third parties or utilization of its contents – in whole or in parts – is forbidden without prior written consent of OmniOn Power. This document does not convey license to any patent or any intellectual property right. Copyright© 2023 OmniOn Power Inc. All rights reserved.