

RoHS  **HF 468 Series Fuse**

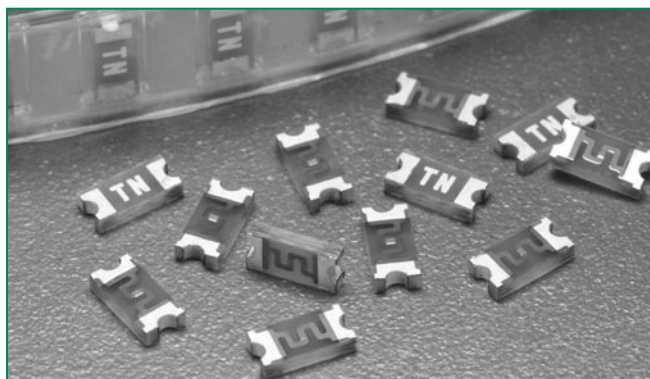

### Description



The 468 Series Time-Lag (Slo-Blo®) SMF is a small (1206 size) thin-film device designed for secondary protection of circuits used in space constrained applications such as hand-held portable electronic devices.

This series is 100% lead-free and meets the requirements of the RoHS directive. New Halogen-Free 468 Series fuses are available—to order use the “HF” suffix. See Part Numbering section for additional information.

### Features

- Complies with electronic industry environmental standards for lead reduction.
- Product is compatible with lead-free solders and higher temperature profiles.
- Time delay feature withstands high inrush currents and prevents nuisance openings.
- Package is visually distinct from fast-acting version for easy identification.
- Top side marking allows visual verification of amperage rating.

### Agency Approvals

AGENCY	AGENCY FILE NUMBER	AMPERE RANGE
	E10480	500MA - 3A
	LR29862	500MA - 3A

### Electrical Characteristics for Series



% of Ampere Rating	Opening Time at 25°C
100%	4 hours, Minimum
200%	1 sec., Min.; 120 sec., Max.
300%	0.05 sec., Min.; 1.5 sec., Max
800%	0.0015 sec., Min.; .05 sec., Max.

### Applications

Secondary protection for space constrained applications:

- Cell phones
- Battery packs
- Digital cameras
- DVD players
- Hard disk drives.

### Electrical Specifications by Item

Ampere Rating (A)	Amp Code	Max Voltage Rating (V)	Interrupting Rating	Nominal Cold Resistance (Ohms)	Nominal Melting I <sup>2</sup> t (A <sup>2</sup> sec)	Nom Voltage Drop (mV)	Nom Power Dissipation (W)	Agency Approvals	
									
0.50	.500	63	50 amperes @63 VAC/VDC	0.27000	0.0310	156.77	0.0784	x	x
1.00	001.	63		0.08250	0.1270	94.70	0.0947	x	x
1.50	01.5	63		0.04750	0.2880	82.32	0.1235	x	x
2.00	002.	63	35 amperes @63 VAC 50 amperes @63 VDC	0.03240	0.5060	77.27	0.1545	x	x
2.50	02.5	63		0.02240	1.0110	73.92	0.1848	x	x
3.00	003.	32	50 amperes @32 VAC/VDC	0.01950	1.2700	72.95	0.2189	x	x

1. Measured at 10% of rated current, 25°C.  
 2. Measured at rated voltage.

## Temperature Derating Curve

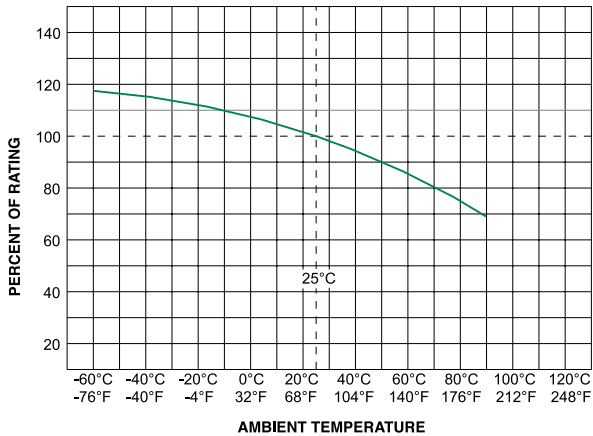

Note:

- Derating depicted in this curve is in addition to the standard derating of 25% for continuous operation.

Example:

For continuous operation at 70 degrees celsius, the fuse should be derated as follows:

$$I = (0.75)(0.80)I_{RAT} = (0.60)I_{RAT}$$

- The temperature derating curve represents the nominal conditions. For questions about temperature derating curve, please consult Littelfuse technical support for assistance.

## Average Time Current Curves

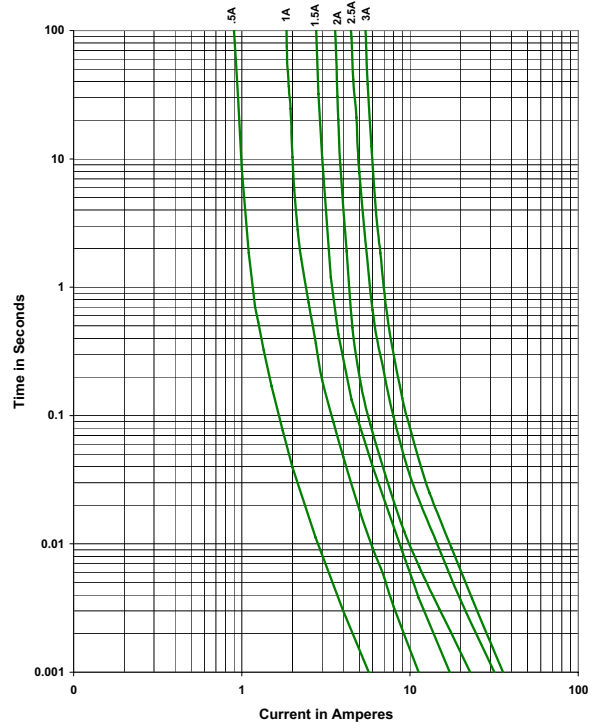

## Soldering Parameters

Reflow Condition		Pb – Free assembly
Pre Heat	- Temperature Min ( $T_{s(min)}$ )	150°C
	- Temperature Max ( $T_{s(max)}$ )	200°C
	- Time (Min to Max) ( $t_s$ )	60 – 180 secs
Average ramp up rate (Liquidus Temp ( $T_L$ ) to peak)		5°C/second max
$T_{s(max)}$ to $T_L$ - Ramp-up Rate		5°C/second max
Reflow	- Temperature ( $T_L$ ) (Liquidus)	217°C
	- Temperature ( $t_L$ )	60 – 150 seconds
Peak Temperature ( $T_p$ )		250 <sup>+0/-5</sup> °C
Time within 5°C of actual peak Temperature ( $t_p$ )		20 – 40 seconds
Ramp-down Rate		5°C/second max
Time 25°C to peak Temperature ( $T_p$ )		8 minutes Max.
Do not exceed		260°C

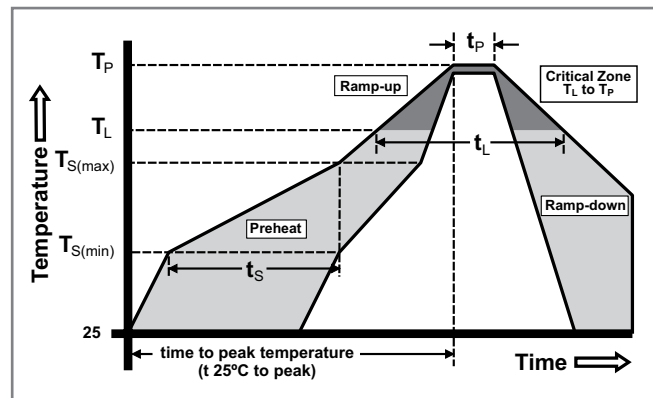

Wave Soldering

260°C, 10 seconds max.

## Product Characteristics

<b>Materials</b>	<b>Body:</b> Epoxy Substrate <b>Terminations:</b> 100% Tin <b>Element Cover Coat:</b> Conformal Coating
<b>Operating Temperature</b>	-55°C to 90°C. Consult temperature derating curve chart. For operation above 90°C please contact Littelfuse
<b>Thermal Shock</b>	Withstands 5 cycles of - 50°C to 125°C
<b>Humidity</b>	MIL-STD-202F, Method 103B, Condition D

<b>Vibration</b>	Withstands 10-55 Hz per MIL-STD-202F, Method 201A and 10-2000 Hz at 20 G's per MIL-STD-202F, Method 204D, Condition D
<b>Insulation Resistance (After Opening)</b>	Greater than 10,000 ohms.
<b>Resistance to Soldering Heat</b>	MIL-STD-202G, Method 210F, Condition D

## Dimensions

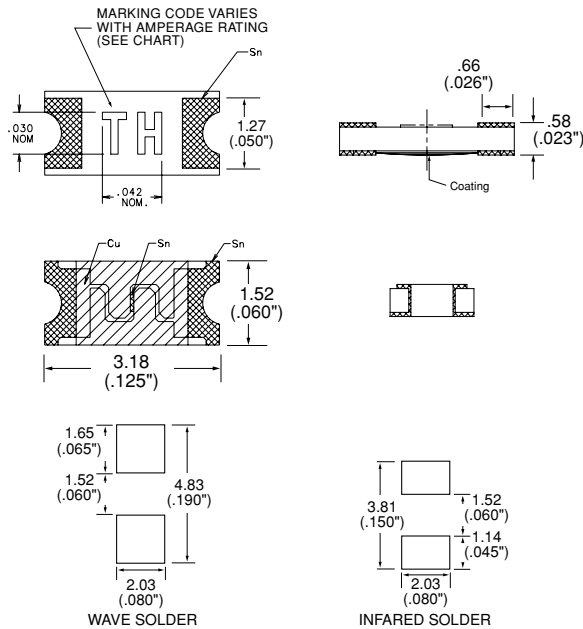

## Part Marking System

Amp Code	Marking Code
.500	<b>TF</b>
001.	<b>TH</b>
01.5	<b>TK</b>
002.	<b>TN</b>
02.5	<b>TO</b>
003.	<b>TP</b>

## Part Numbering System

**0468002.NRHF**

**SERIES**

**AMP Code**

The dot is positioned before the Packaging Suffix with whole ratings and within the numbering sequence for fractional ratings. Refer to Amp Code column in the Electrical Specifications table.

**PACKAGING Code**

NR = Tape and Reel, 5000 pcs

**'HF' SUFFIX**

**HALOGEN FREE ITEM**

**Example:**  
1.5 amp product is 0468**01.5**NRHF (2 amp product shown above).

## Packaging

Packaging Option	Packaging Specification	Quantity	Quantity & Packaging Code
Tape & Reel – 8mm tape	EIA-481 Rev. D (IEC 60286, part 3)	5000	NR