

Design Data	
Commutation	Brushed
Direction of rotation	Bi-directional
Bearing type	

Performance data		
Rated voltage [V]	$U_N$	24
Nominal torque [Nm]	$M_N$	0.50
No-load speed [ $\text{min}^{-1}$ ]	$n_0$	55.0
Nominal power [W]	$P_N$	2.56
Nominal current [A]	$I_N$	0.5
Nominal force [kN]	$F_N$	0.00
Duty cycle		s3

Sensor data	
Pulses	0
Output channels	0

Other data	
Gear ratio	109/1
Gear wheel material	
Suppression components	
Enclosure class	IP40
Weight [kg]	0.180

Remarks:

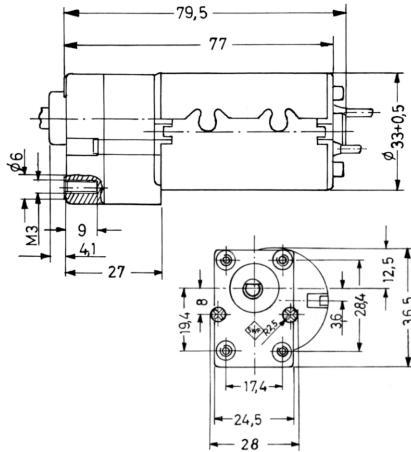

### Motor picture



### Characteristic curves

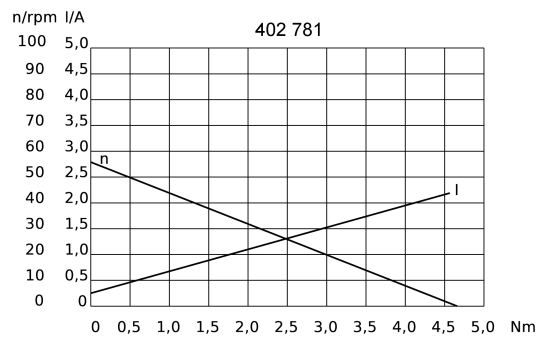

### Output shaft drawing (W), Wiring diagrams (S) and Connector layout (K)

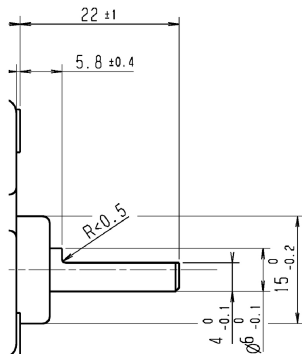

### S 30

