

**PKM4000NH series** Fully regulated Bus Converters  
 Input 40-60 V, Output up to 80 A / 864 W

1/28701-BMR669 Rev G      November 2017  
 © Flex

### Key Features

- Turn-on at 38V to limit input current at start-up
- Optimized for 52-58Vin applications
- Basic insulation for open frame and unearthed baseplate
- 2250V input to output functional isolation
- Input overvoltage suppression
- Soft-start for handling of high capacitance loads
- Optional Baseplate
- Optional single output pins
- Delayed hiccup OCP, OTP, OVP and under voltage lockout



### General Characteristics

- **Technical Data**
  - Input voltage range: 40-60 V
  - Output voltage range\*:  
 8.6-10.8 V (40-60 Vin);  
 10.8 V (52-60 Vin);
  - Max output current: 80A
  - Efficiency: typical 97 % at 50% load
  - Weight 52 grams
  - Mechanical Dimensions LxWxH
  - Footprint: 57.9 x 36.8 x 11.4 mm  
 (2.28 x 1.45 x 0.45 inch)
- \*) Regulated for optimum efficiency

#### Safety Approvals



#### Design for Environment



Meets requirements in high-temperature lead-free soldering processes.

### Contents

Ordering Information	2
General Information	2
Safety Specification	3
Absolute Maximum Ratings	4
Electrical Specification	
10.8 V, 70 A / 756 W	PKM 4717 NH PI ..... 5
10.8 V, 80 A / 864 W	PKM 4817 NH PIHS ..... 12
EMC Specification	18
Operating Information	19
Thermal Consideration	24
Connections	26
Mechanical Information	27
Soldering Information	30
Delivery Information	30
Product Qualification Specification	31

## Technical Specification

**PKM4000NH series Fully regulated Bus Converters**  
Input 40-60 V, Output up to 80 A / 864 W

1/28701-BMR669 Rev G November 2017

© Flex

## Ordering Information

Product program	Output
PKM 4717NH PI	10.8 V @ 70 A
PKM 4817NH PIHS*	10.8 V @ 80 A

\*80A is only available with the double power pin, baseplate version.

## Product number and Packaging

PKM 4717 NH n <sub>1</sub> n <sub>2</sub> n <sub>3</sub> n <sub>4</sub>				
Options	n <sub>1</sub>	n <sub>2</sub>	n <sub>3</sub>	n <sub>4</sub>
Mounting option	o			
Baseplate		o		
Power pinning			o	
Lead length				o

Options	Description
n <sub>1</sub>	PI Through hole
n <sub>2</sub>	Open frame* HS Baseplate
n <sub>3</sub>	Double power pin* SP Single power pin
n <sub>4</sub>	5.33 mm* LA 3.69 mm LB 4.57 mm

\* Standard variant (i.e. no option selected).

For example, the through hole version product with baseplate, and short pin is PKM 4717NH PIHSSPLA.

## General Information

## Reliability

The failure rate ( $\lambda$ ) and mean time between failures (MTBF =  $1/\lambda$ ) is calculated at max output power and an operating ambient temperature ( $T_A$ ) of +40°C. Flex Power Modules uses Telcordia SR-332 Issue 2 Method 1 to calculate the mean steady-state failure rate and standard deviation ( $\sigma$ ).

Telcordia SR-332 Issue 2 also provides techniques to estimate the upper confidence levels of failure rates based on the mean and standard deviation.

Mean steady-state failure rate, $\lambda$	Std. deviation, $\sigma$
299 nFailures/h	36 nFailures/h

MTBF (mean value) for the PKM-NH series = 3.34 Mh.  
MTBF at 90% confidence level = 2.89 Mh

## Compatibility with RoHS requirements

The products are compatible with the relevant clauses and requirements of the RoHS directive 2011/65/EU and have a maximum concentration value of 0.1% by weight in homogeneous materials for lead, mercury, hexavalent chromium, PBB and PBDE and of 0.01% by weight in homogeneous materials for cadmium.

Exemptions in the RoHS directive utilized in Flex Power Modules products are found in the Statement of Compliance document.

Flex Power Modules fulfills and will continuously fulfill all its obligations under regulation (EC) No 1907/2006 concerning the registration, evaluation, authorization and restriction of chemicals (REACH) as they enter into force and is through product materials declarations preparing for the obligations to communicate information on substances in the products.

## Quality Statement

The products are designed and manufactured in an industrial environment where quality systems and methods like ISO 9000, Six Sigma, and SPC are intensively in use to boost the continuous improvements strategy. Infant mortality or early failures in the products are screened out and they are subjected to an ATE-based final test. Conservative design rules, design reviews and product qualifications, plus the high competence of an engaged work force, contribute to the high quality of the products.

## Warranty

Warranty period and conditions are defined in Flex Power Modules General Terms and Conditions of Sale.

## Limitation of Liability

Flex Power Modules does not make any other warranties, expressed or implied including any warranty of merchantability or fitness for a particular purpose (including, but not limited to, use in life support applications, where malfunctions of product can cause injury to a person's health or life).

## © Flex 2017

The information and specifications in this technical specification is believed to be correct at the time of publication. However, no liability is accepted for inaccuracies, printing errors or for any consequences thereof. Flex reserves the right to change the contents of this technical specification at any time without prior notice.

## Technical Specification

<b>PKM4000NH series Fully regulated Bus Converters</b> Input 40-60 V, Output up to 80 A / 864 W	1/28701-BMR669 Rev G      November 2017
	© Flex

**Safety Specification****General information**

Flex Power Modules DC/DC converters and DC/DC regulators are designed in accordance with the safety standards IEC 60950-1, EN 60950-1 and UL 60950-1 *Safety of Information Technology Equipment*.

IEC/EN/UL 60950-1 contains requirements to prevent injury or damage due to the following hazards:

- Electrical shock
- Energy hazards
- Fire
- Mechanical and heat hazards
- Radiation hazards
- Chemical hazards

On-board DC/DC converters, Power interface modules and DC/DC regulators are defined as component power supplies. As components they cannot fully comply with the provisions of any safety requirements without "conditions of acceptability". Clearance between conductors and between conductive parts of the component power supply and conductors on the board in the final product must meet the applicable safety requirements. Certain conditions of acceptability apply for component power supplies with limited stand-off (see Mechanical Information and Safety Certificate for further information). It is the responsibility of the installer to ensure that the final product housing these components complies with the requirements of all applicable safety standards and regulations for the final product.

Component power supplies for general use should comply with the requirements in IEC/EN/UL 60950/1 *Safety of Information Technology Equipment*. Product related standards, e.g. IEEE 802.3af *Power over Ethernet*, and ETS-300132-2 *Power interface at the input to telecom equipment, operated by direct current (dc)* are based on IEC/EN/UL 60950-1 with regards to safety.

Flex Power Modules DC/DC converters, Power interface modules and DC/DC regulators are UL 60950-1 recognized and certified in accordance with EN 60950-1. The flammability rating for all construction parts of the products meet requirements for V-0 class material according to IEC 60695-11-10, *Fire hazard testing, test flames – 50 W* horizontal and vertical flame test methods.

**Isolated DC/DC converters & Power interface modules**

The product may provide basic or functional insulation between input and output according to IEC/EN/UL 60950-1 (see Safety Certificate), different conditions shall be met if the output of a basic or a functional insulated product shall be considered as safety extra low voltage (SELV).

For basic insulated products (see Safety Certificate) the output is considered as safety extra low voltage (SELV) if one of the following conditions is met:

- The input source provides supplementary or double or reinforced insulation from the AC mains according to IEC/EN/UL 60950-1.
- The input source provides functional or basic insulation from the AC mains and the product's output is reliably connected to protective earth according to IEC/EN/UL 60950-1.

For functional insulated products (see Safety Certificate) the output is considered as safety extra low voltage (SELV) if one of the following conditions is met:

- The input source provides double or reinforced insulation from the AC mains according to IEC/EN/UL 60950-1.
- The input source provides basic or supplementary insulation from the AC mains and the product's output is reliably connected to protective earth according to IEC/EN/UL 60950-1.
- The input source is reliably connected to protective earth and provides basic or supplementary insulation according to IEC/EN/UL 60950-1 and the maximum input source voltage is 60 Vdc.

Galvanic isolation between input and output is verified in an electric strength test and the isolation voltage ( $V_{iso}$ ) meets the voltage strength requirement for basic insulation according to IEC/EN/UL 60950-1.

It is recommended to use a slow blow fuse at the input of each DC/DC converter. If an input filter is used in the circuit the fuse should be placed in front of the input filter. In the rare event of a component problem that imposes a short circuit on the input source, this fuse will provide the following functions:

- Isolate the fault from the input power source so as not to affect the operation of other parts of the system
- Protect the distribution wiring from excessive current and power loss thus preventing hazardous overheating

Technical Specification

**PKM4000NH series** Fully regulated Bus Converters  
 Input 40-60 V, Output up to 80 A / 864 W

1/28701-BMR669 Rev G November 2017  
 © Flex

**Absolute Maximum Rating**

Characteristics		min	typ	max	Unit
$T_{P1}$	Operating Temperature (see Thermal Consideration section)	-40		+125	°C
$T_S$	Storage temperature	-55		+125	°C
$V_I$	Input voltage	-0.5		+72	V
$C_{out}$	Output capacitance	470			µF
$V_{iso}$	Isolation voltage (input to output qualification test voltage)			2250	Vdc
$V_{iso}$	Isolation voltage (input to baseplate qualification test voltage)			1500	Vdc
$V_{iso}$	Isolation voltage (baseplate to output qualification test voltage)			750	Vdc
$V_{tr}$	Input voltage transient ( $t_p$ 100msec), non operational			80	V
$V_{RC}$	Remote Control pin voltage (see Operating Information section)	Positive logic option		6	V
		Negative logic option	-0.5	6	V

Stress in excess of Absolute Maximum Ratings may cause permanent damage. Absolute Maximum Ratings, sometimes referred to as no destruction limits, are normally tested with one parameter at a time exceeding the limits in the Electrical Specification. If exposed to stress above these limits, function and performance may degrade in an unspecified manner.

**Fundamental Circuit Diagram**

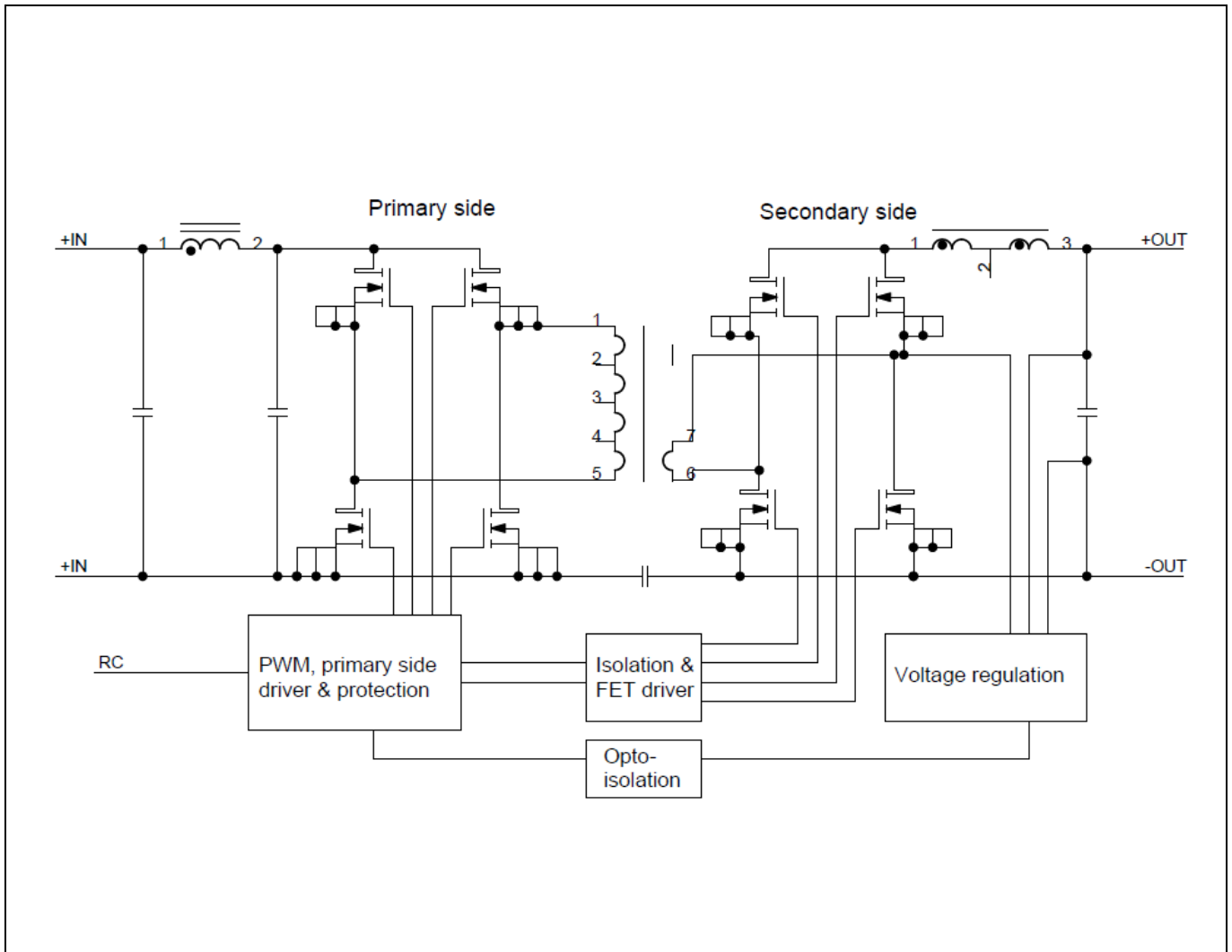

## Technical Specification

**PKM4000NH series Fully regulated Bus Converters**  
Input 40-60 V, Output up to 80 A / 864 W

1/28701-BMR669 Rev G November 2017

© Flex

**Electrical Specification**  
**10.8 V, 70 A / 756 W**

**PKM 4717 NH PI**

$T_{P1} = -30$  to  $+90^{\circ}\text{C}$ ,  $V_I = 40$  to  $60$  V, unless otherwise specified under Conditions.

Typical values given at:  $T_{P1} = +25^{\circ}\text{C}$ ,  $V_I = 54$  V,  $I_O = 70$  A, unless otherwise specified under Conditions.

Additional  $C_{in} = 470$   $\mu\text{F}$ ,  $C_{out} = 470$   $\mu\text{F}$ . See Operating Information section for selection of capacitor types.

Characteristics		Conditions	min	typ	max	Unit
$V_I$	Input voltage range		40		60	V
$V_{loff}$	Turn-off input voltage	Decreasing input voltage	34	35	36	V
$V_{Ion}$	Turn-on input voltage	Increasing input voltage	37	38	39	V
$C_I$	Internal input capacitance	$V_I = 54$ V		15		$\mu\text{F}$
$P_O$	Output power	$V_I = 52-60$ V	0		756	W
$P_{Om}$	Output power maximum	$V_I = 40-52$ V see Note 1	595		756	W
$\eta$	Efficiency see Note 2	50% of max $I_O$		96.9		%
		max $I_O$		96.7		
		50% of max $I_O$ , $V_I = 57$ V		96.7		
		max $I_O$ , $V_I = 57$ V		96.6		
$P_d$	Power Dissipation	max $I_O$		26	40	W
$P_{li}$	Input idling power	$I_O = 0$ A, $V_I = 54$ V		5.6		W
$P_{RC}$	Input standby power	$V_I = 54$ V (turned off with RC)		0.3		W
$f_s$	Switching frequency (Ripple $f_s$ )	0-100 % of max $I_O$	375	400	425	kHz

$V_{Oi}$	Output voltage initial setting			10.85		V
$V_O$	Output voltage tolerance band	3-100% of max $I_O$ , $V_I = 52-60$ V	10.48		11.12	V
	Line regulation	$V_I = 52-60$ V, max $I_O$		1	10	mV
	Load regulation	$V_I = 54$ V, 0-100% of max $I_O$		3	10	mV
$V_{tr}$	Load transient voltage deviation	$V_I = 54$ V, Load step 25-75-25% of max $I_O$ , $di/dt = 5$ A/ $\mu\text{s}$ see Note 3		250	600	mV
$t_{tr}$	Load transient recovery time			60	200	$\mu\text{s}$
$t_r$	Ramp-up time (from 10-90% of $V_{Oi}$ )	3-100% of max $I_O$ , $V_I = 54$ V		3	5	ms
$t_s$	Start-up time (from $V_I$ connection to 90% of $V_{Oi}$ )			6	10	ms
$t_f$	$V_I$ shut-down fall time (from $V_I$ off to 10% of $V_O$ )	max $I_O$		1.8		ms
		$I_O = 0$ A		13		s
$t_{RC}$	RC start-up time	max $I_O$		6		ms
	RC shut-down fall time (from RC off to 10% of $V_O$ )	max $I_O$		1.3		ms
		$I_O = 0$ A		19		s
$I_O$	Output current		0		70	A
$I_{lim}$	Current limit threshold	$T_{P1} < \max T_{P1}$	90	104	120	A
$I_{sc}$	Short circuit current	$T_{P1} = 25^{\circ}\text{C}$ , see Note 4		11		A
$C_{out}$	Recommended Capacitive Load	$T_{P1} = -30^{\circ}\text{C} - 90^{\circ}\text{C}$ , see Note 5	2200		15000	$\mu\text{F}$
$C_{out}$	Recommended Capacitive Load	$T_{P1} = -10^{\circ}\text{C} - 90^{\circ}\text{C}$ , see Note 5	470		15000	$\mu\text{F}$
$C_{out\_ESR}$	See Note 6		10		500	m $\Omega$
$V_{Oac}$	Output ripple & noise	See ripple & noise section, $V_{Oi}$		200	500	mVp-p
OVP <sub>in</sub>	Input Overvoltage Protection	0-100% of max $I_O$		78		V
OVP	Over voltage protection			12.3		V
RC	Sink current	See operating information	0.5			mA
	Trigger level	See operating information	1	2		V
	Response time		0.1		0.5	ms

Note 1: Represented by available power graph, power limited by maximum output current at low  $V_{in}$ .

Note 2: Efficiency data measured with half load on each pin pair.

Note 3: As a rule of thumb 100  $\mu\text{F}/\text{A}$  is used, i.e. 7 mF at max  $I_O$ .

Note 4: Delayed hiccup OCP, stated values indicates RMS value.

Note 5: Detailed information in Output Decoupling Capacitors.

Note 6: ESR is highly temperature dependent for some types of capacitors e.g. aluminum electrolyte capacitors will freeze in cold environment.

Technical Specification

**PKM4000NH series** Fully regulated Bus Converters  
 Input 40-60 V, Output up to 80 A / 864 W

1/28701-BMR669 Rev G November 2017  
 © Flex

**Typical Characteristics**  
**10.8 V, 70 A / 756 W**

**PKM 4717 NH PI**

**Efficiency**

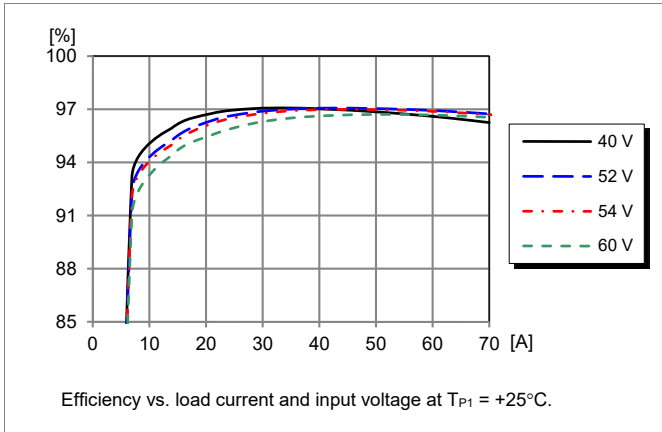

**Power Dissipation**

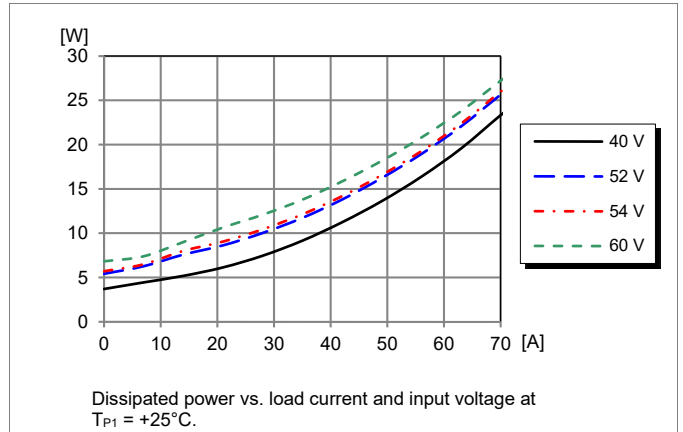

**Output Characteristics**

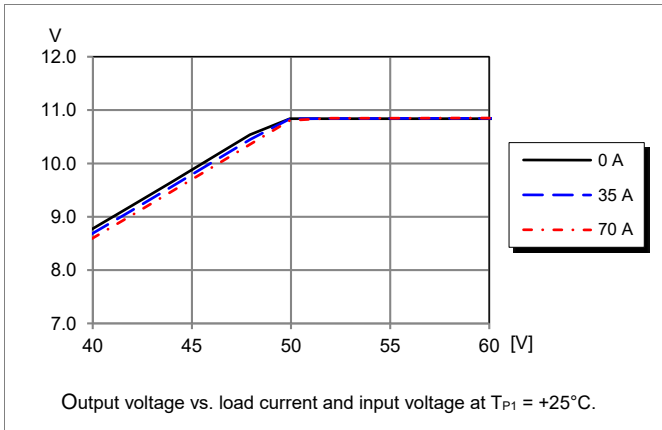

**Current Limit Characteristics**

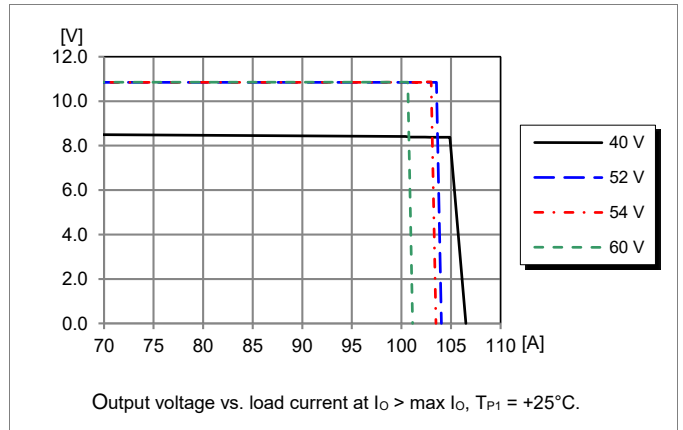

**Available Power**

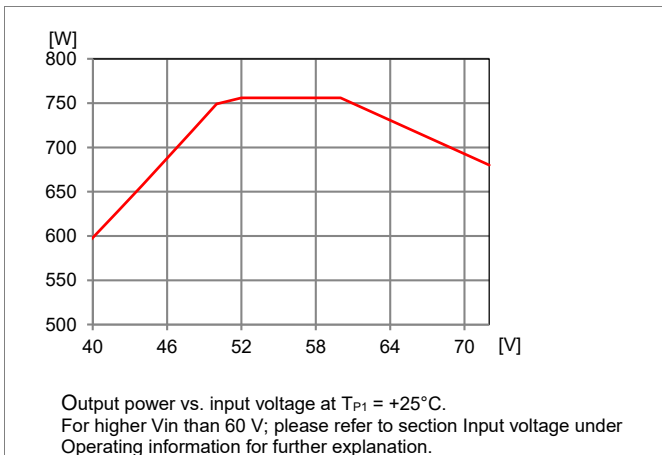

## Technical Specification

**PKM4000NH series Fully regulated Bus Converters**  
 Input 40-60 V, Output up to 80 A / 864 W

1/28701-BMR669 Rev G      November 2017  
 © Flex

### Typical Characteristics 10.8 V, 70 A / 756 W

### PKM 4717 NH PI

#### Start-up

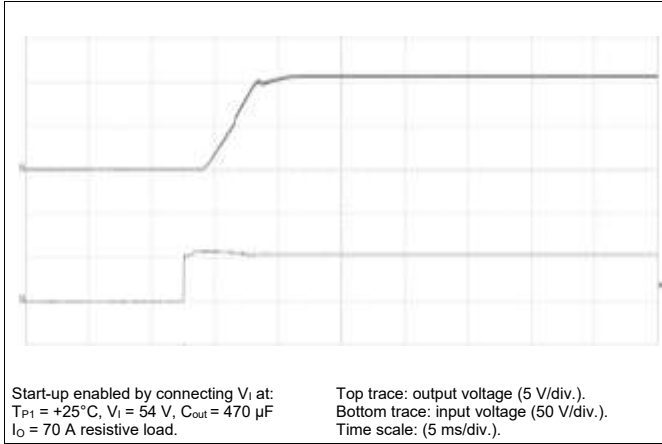

#### Shut-down

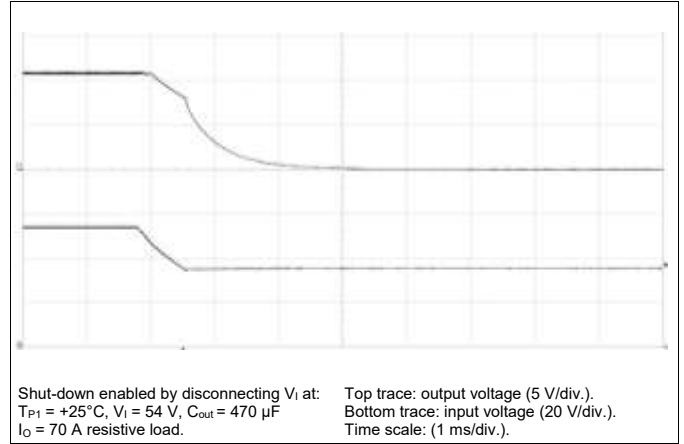

#### Output Ripple & Noise

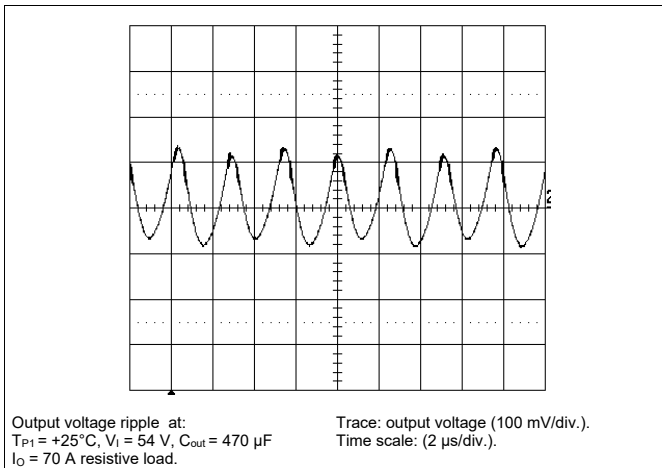

#### Output Load Transient Response

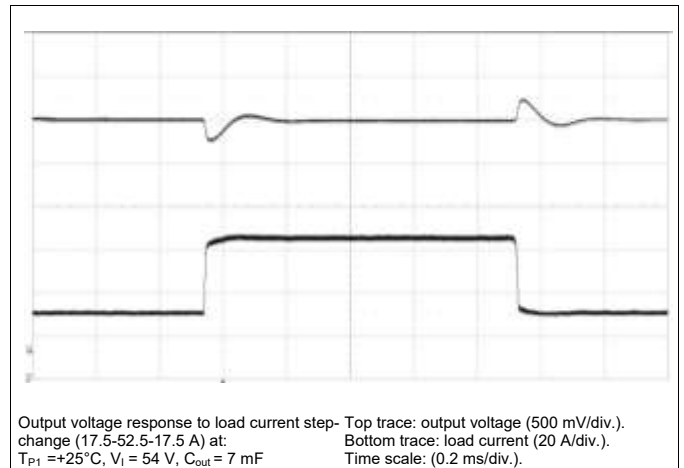

Technical Specification

**PKM4000NH series Fully regulated Bus Converters**  
 Input 40-60 V, Output up to 80 A / 864 W

1/28701-BMR669 Rev G November 2017  
 © Flex

**Typical Characteristics**  
**10.8 V, 70 A / 756 W**

**PKM 4717 NH PI**

**Output Power Derating – Single pin and base plate (PKM4717 NH PI HS SP)**

**Thermal Resistance – Single pin and base plate (PKM4717 NH PI HS SP)**

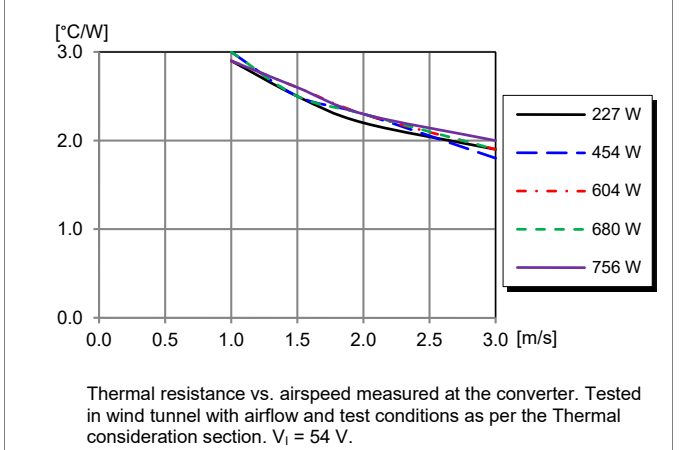
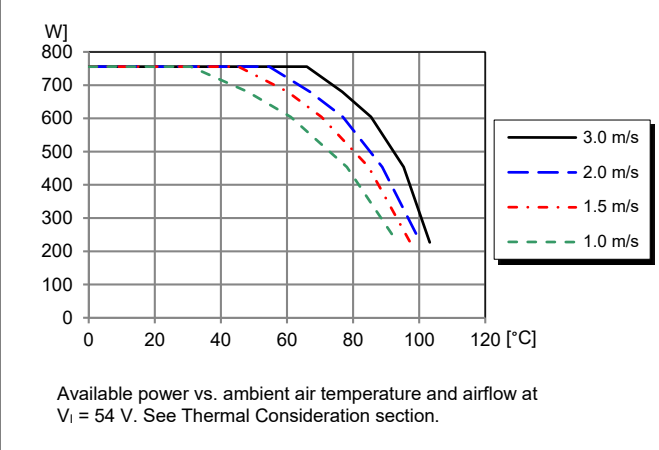

**Output Power Derating – Dual pin open frame (PKM 4717 NH PI)**

**Thermal Resistance – Dual pin open frame (PKM 4717 NH PI)**

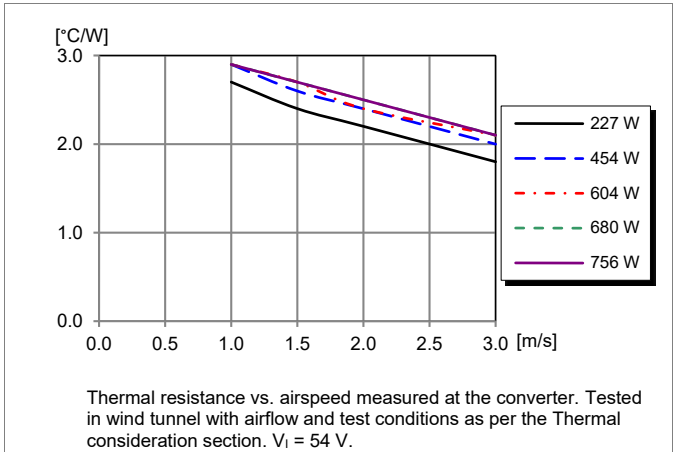
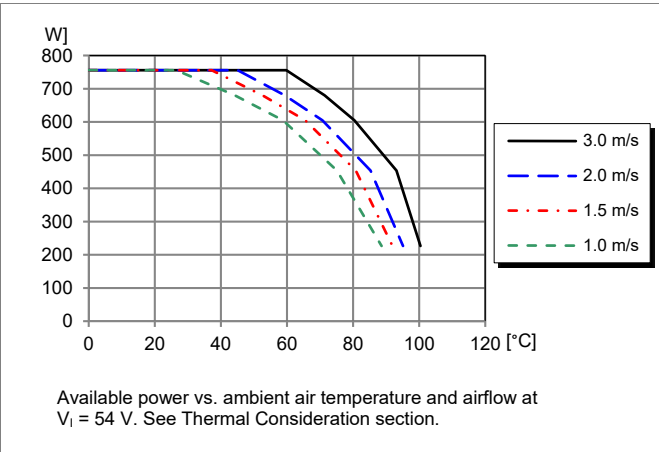

**Output Power Derating – Dual pin and base plate (PKM 4717 NH PI HS)**

**Thermal Resistance – Dual pin and base plate (PKM 4717 NH PI HS)**

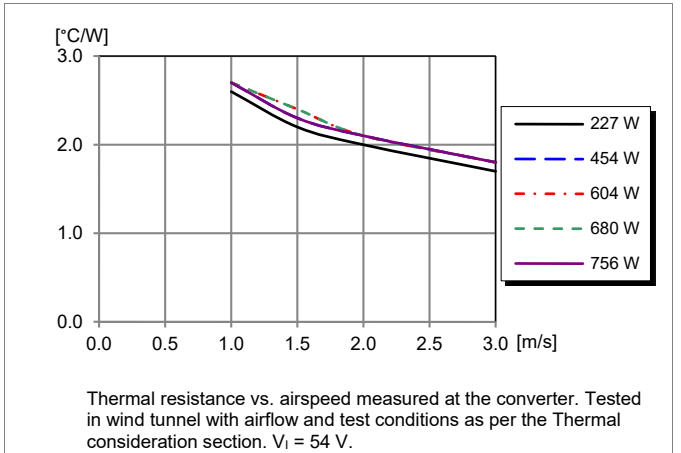
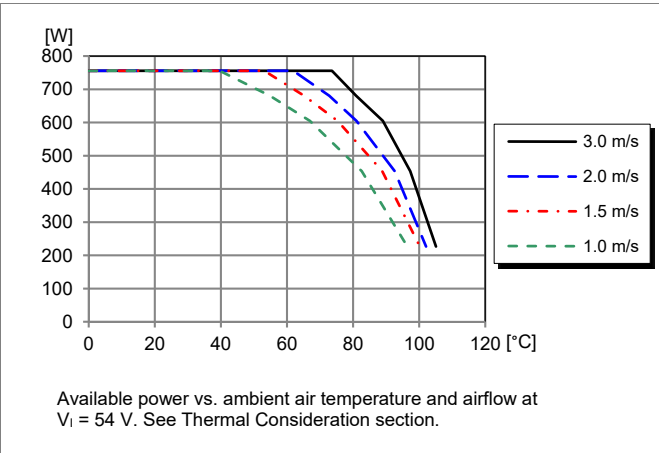



Technical Specification

**PKM4000NH series** Fully regulated Bus Converters  
 Input 40-60 V, Output up to 80 A / 864 W

1/28701-BMR669 Rev G November 2017  
 © Flex

**Typical Characteristics**  
**10.8 V, 70 A / 756 W**

**PKM 4717 NH PI**

**Output Power Derating – Dual pin, baseplate and 1/2" heat sink**  
**(PKM 4717 NH PI HS + 1/2" heat sink)**

**Thermal Resistance – Dual pin, baseplate and 1/2" heat sink**  
**(PKM 4717 NH PI HS + 1/2" heat sink)**

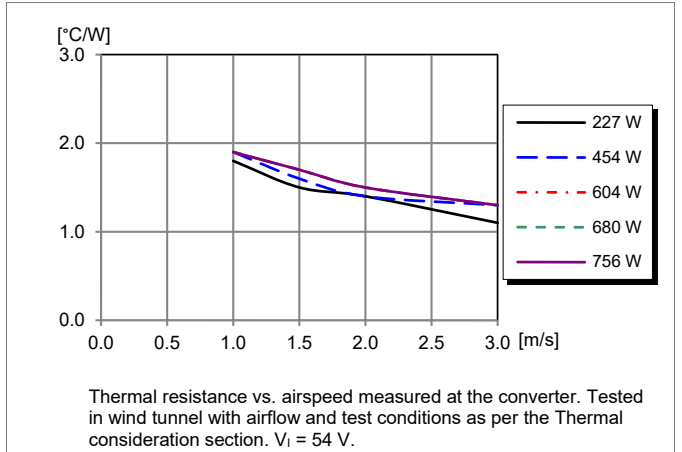
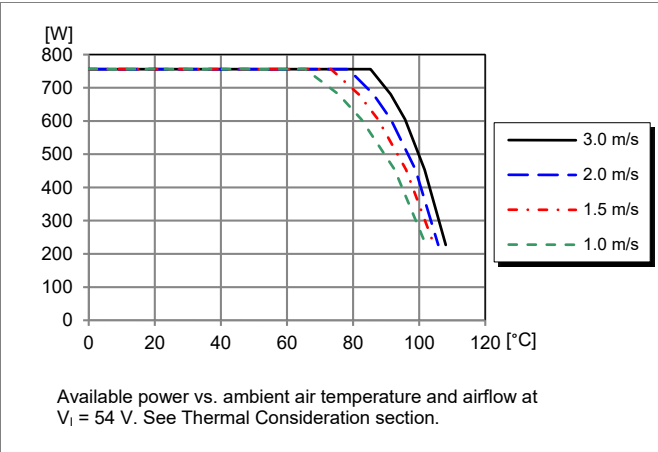

Technical Specification

**PKM4000NH series Fully regulated Bus Converters**  
 Input 40-60 V, Output up to 80 A / 864 W

1/28701-BMR669 Rev G November 2017  
 © Flex

**Typical Characteristics**  
**10.8 V, 70 A / 756 W**

**PKM 4717 NH PI**

**Output Power Derating – Different options @ 1.0 m/s**

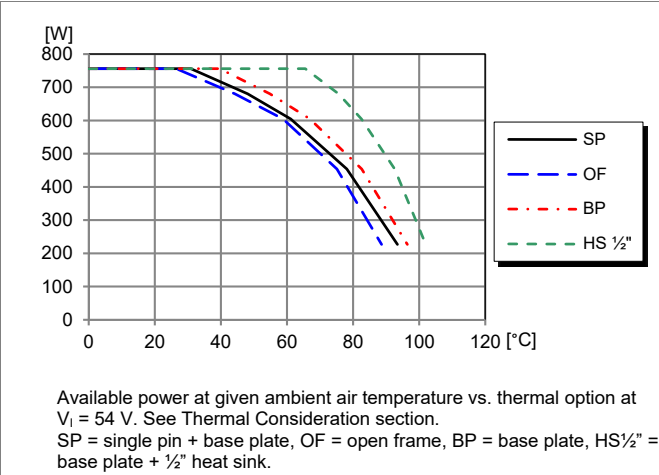

**Thermal Resistance – Different options @ 1.0 m/s**

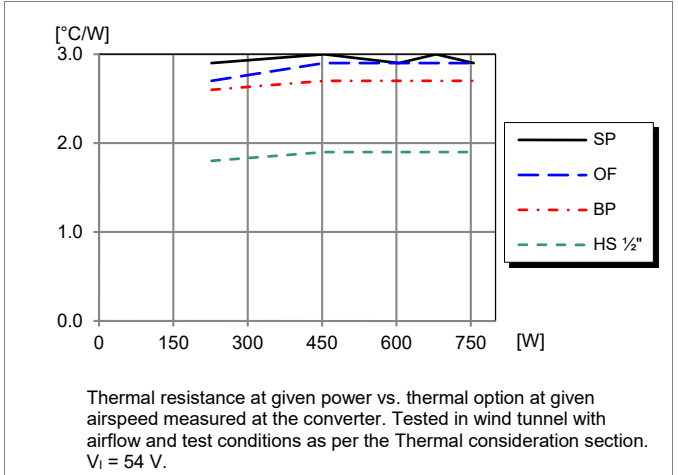

**Output Power Derating – Different options @ 1.5 m/s**

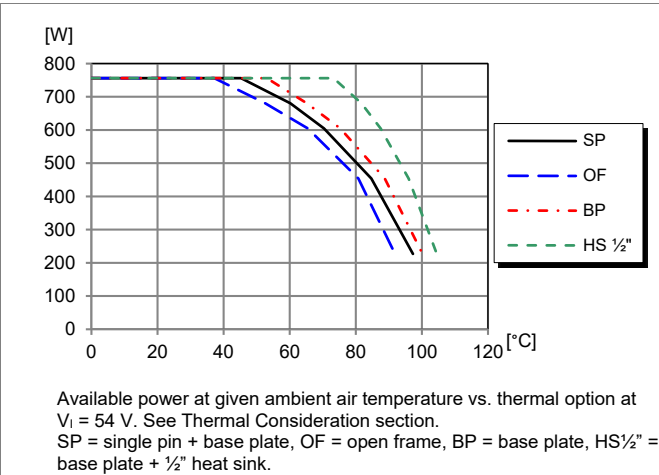

**Thermal Resistance – Different options @ 1.5 m/s**

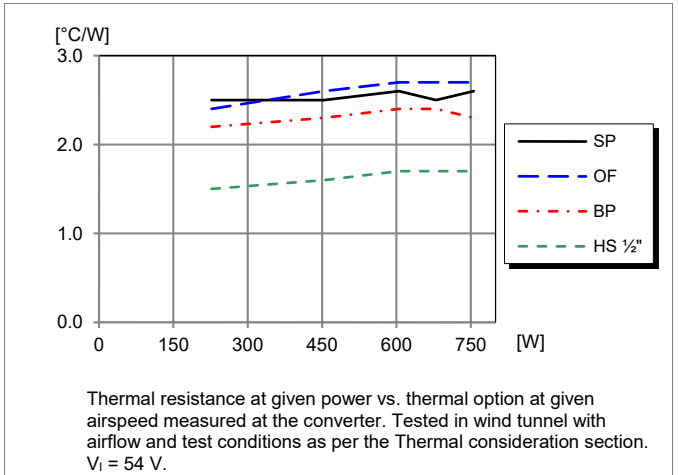

**Output Power Derating – Different options @ 2.0 m/s**

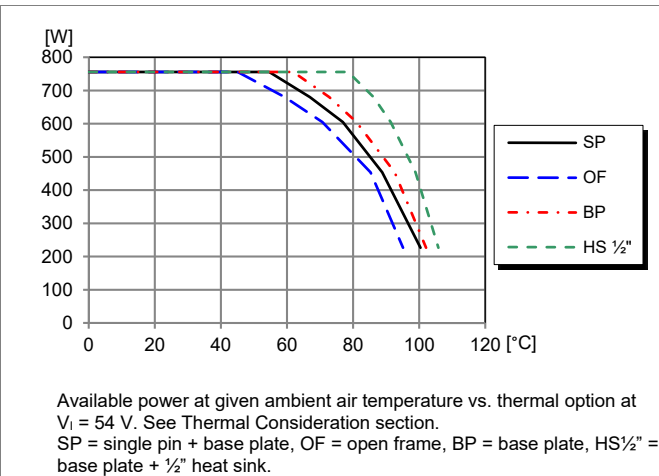

**Thermal Resistance – Different options @ 2.0 m/s**

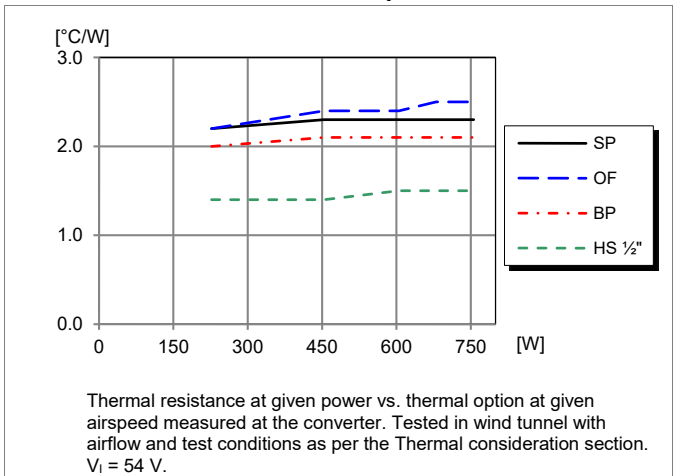

Technical Specification

**PKM4000NH series** Fully regulated Bus Converters  
 Input 40-60 V, Output up to 80 A / 864 W

1/28701-BMR669 Rev G November 2017  
 © Flex

**Typical Characteristics**  
**10.8 V, 70 A / 756 W**

**PKM 4717 NH PI**

**Output Power Derating – Different options @ 3.0 m/s**

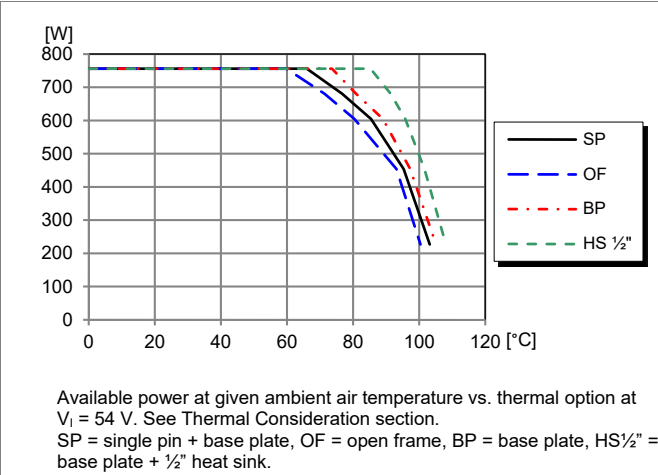

**Thermal Resistance – Different options @ 3.0 m/s**

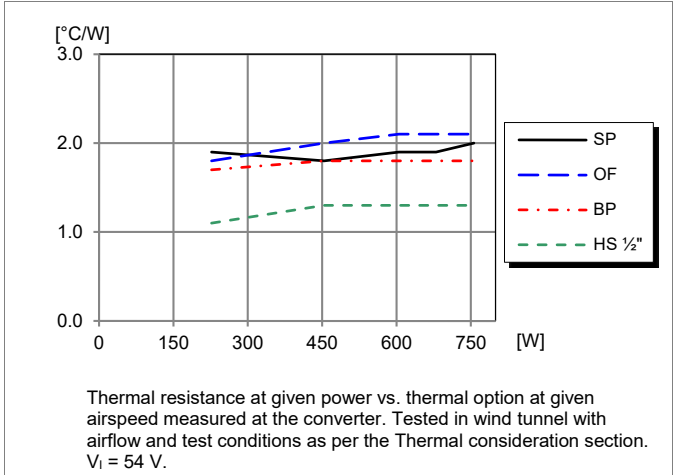

**Output Current Derating – Cold wall sealed box**

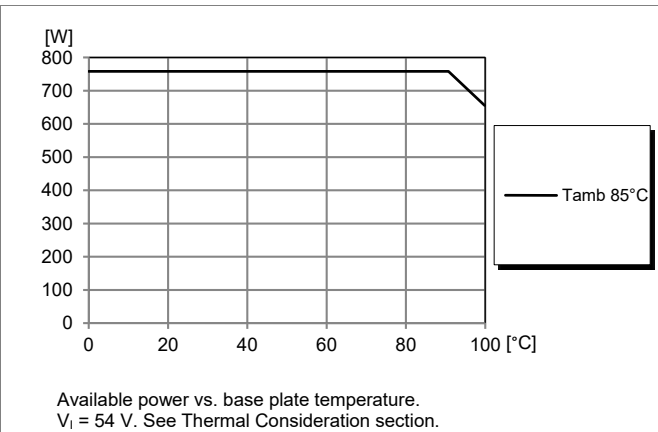

## Technical Specification

**PKM4000NH series Fully regulated Bus Converters**  
Input 40-60 V, Output up to 80 A / 864 W

1/28701-BMR669 Rev G November 2017

© Flex

**Electrical Specification**  
**10.8 V, 80 A / 864 W**

**PKM 4817 NH PIHS**

$T_{P1} = -30$  to  $+90^{\circ}\text{C}$ ,  $V_I = 40$  to  $60$  V, unless otherwise specified under Conditions.

Typical values given at:  $T_{P1} = +25^{\circ}\text{C}$ ,  $V_I = 54$  V,  $I_O = 80$  A, unless otherwise specified under Conditions.

Additional  $C_{in} = 470$   $\mu\text{F}$ ,  $C_{out} = 470$   $\mu\text{F}$ . See Operating Information section for selection of capacitor types.

Characteristics		Conditions	min	typ	max	Unit
$V_I$	Input voltage range		40		60	V
$V_{loff}$	Turn-off input voltage	Decreasing input voltage	34	35	36	V
$V_{lon}$	Turn-on input voltage	Increasing input voltage	37	38	39	V
$C_I$	Internal input capacitance	$V_I = 54$ V		15		$\mu\text{F}$
$P_O$	Output power	$V_I = 52-60$ V	0		864	W
$P_O$	Output power maximum	$V_I = 40-52$ V see Note 1	595		864	W
$\eta$	Efficiency Note 2	50% of max $I_O$		96.9		%
		max $I_O$		96.3		
		50% of max $I_O$ , $V_I = 57$ V		96.6		
		max $I_O$ , $V_I = 57$ V		96.3		
$P_d$	Power Dissipation	max $I_O$		33	45	W
$P_{li}$	Input idling power	$I_O = 0$ A, $V_I = 54$ V		5.4		W
$P_{RC}$	Input standby power	$V_I = 54$ V (turned off with RC)		0.3		W
$f_s$	Switching frequency (Ripple $f_s$ )	0-100 % of max $I_O$	375	400	425	kHz

$V_{oi}$	Output voltage initial setting and accuracy			10.8		V
$V_O$	Output voltage tolerance band	3-100% of max $I_O$ , $V_I = 52-60$ V	10.48		11.12	V
	Line regulation	$V_I = 52-60$ V, max $I_O$		1	10	mV
	Load regulation	$V_I = 54$ V, 0-100% of max $I_O$		3	10	mV
$V_{tr}$	Load transient voltage deviation	$V_I = 54$ V, Load step 25-75-25% of max $I_O$ , $di/dt = 5$ A/ $\mu\text{s}$ see Note 3		300	650	mV
$t_{tr}$	Load transient recovery time			60	200	$\mu\text{s}$
$t_r$	Ramp-up time (from 10-90% of $V_{oi}$ )	3-100% of max $I_O$ , $V_I = 54$ V		4	6	ms
$t_s$	Start-up time (from $V_I$ connection to 90% of $V_{oi}$ )			7	10	ms
$t_f$	$V_I$ shut-down fall time (from $V_I$ off to 10% of $V_O$ )	max $I_O$		2		ms
		$I_O = 0$ A		13		s
$t_{RC}$	RC start-up time	max $I_O$		7		ms
	RC shut-down fall time (from RC off to 10% of $V_O$ )	max $I_O$		1.5		ms
		$I_O = 0$ A		20		s
$I_O$	Output current		0		80	A
$I_{lim}$	Current limit threshold	$T_{P1} < \max T_{P1}$	90	104	120	A
$I_{sc}$	Short circuit current	$T_{P1} = 25^{\circ}\text{C}$ , see Note 4		11		A
$C_{out}$	Recommended Capacitive Load	$T_{P1} = -30^{\circ}\text{C} - 90^{\circ}\text{C}$ , see Note 5	2200		15000	$\mu\text{F}$
$C_{out}$	Recommended Capacitive Load	$T_{P1} = -10^{\circ}\text{C} - 90^{\circ}\text{C}$ , see Note 5	470		15000	$\mu\text{F}$
$C_{out\_ESR}$	See Note 6		10		500	m $\Omega$
$V_{Oac}$	Output ripple & noise	See ripple & noise section, $V_{oi}$		240	600	mVp-p
OVP <sub>in</sub>	Input Overvoltage Protection	0-100% of max $I_O$		78		V
OVP	Over voltage protection			12.3		V
RC	Sink current	See operating information	0.5			mA
	Trigger level	See operating information	1	2		V
	Response time		0.1		0.5	ms

Note 1: Represented by available power graph, power limited by maximum output current at low  $V_{in}$ .

Note 2: Efficiency data measured with half load on each pin pair.

Note 3: As a rule of thumb 100  $\mu\text{F}/\text{A}$  is used, i.e. 8 mF at max  $I_O$ .

Note 4: Delayed hiccup OCP, stated values indicates RMS value.

Note 5: Detailed information in Output Decoupling Capacitors.

Note 6: ESR is highly temperature dependent for some types of capacitors e.g. aluminum electrolyte capacitors will freeze in cold environment.

Technical Specification

**PKM4000NH series** Fully regulated Bus Converters  
 Input 40-60 V, Output up to 80 A / 864 W

1/28701-BMR669 Rev G November 2017  
 © Flex

**Typical Characteristics**  
 10.8 V, 80 A / 864 W

**PKM 4817 NH PIHS**

**Efficiency**

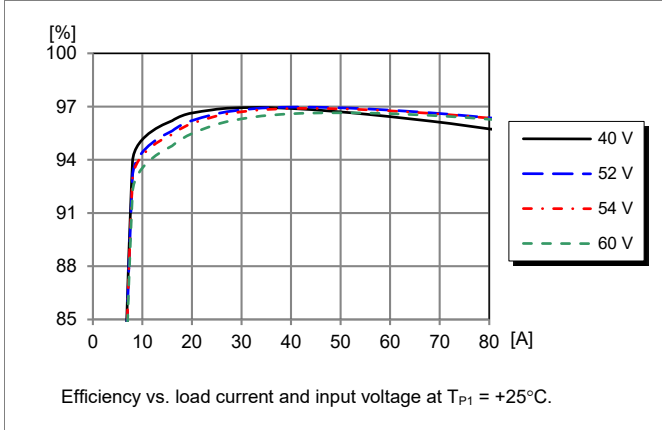

**Power Dissipation**

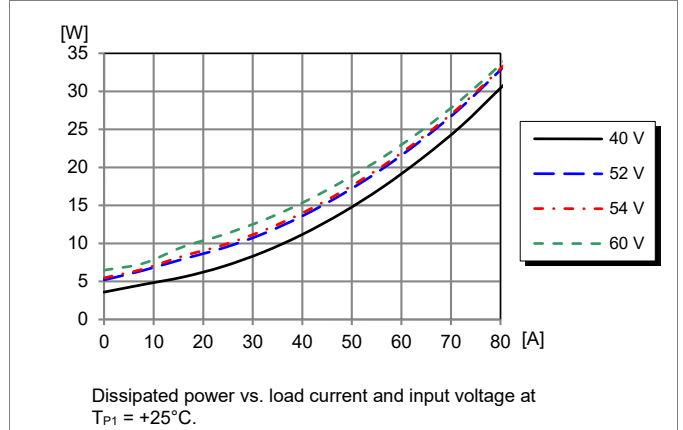

**Output Characteristics**

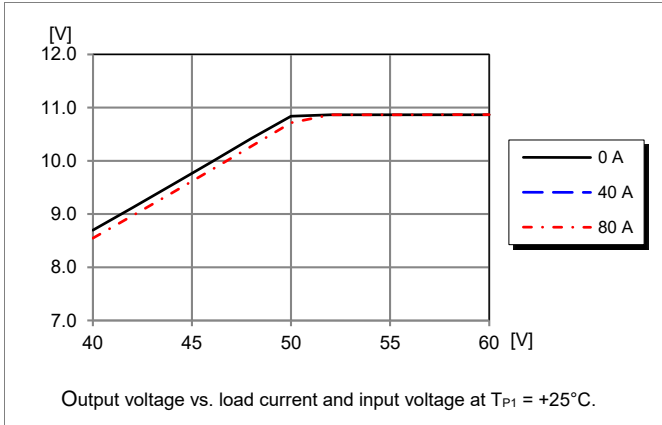

**Current Limit Characteristics**

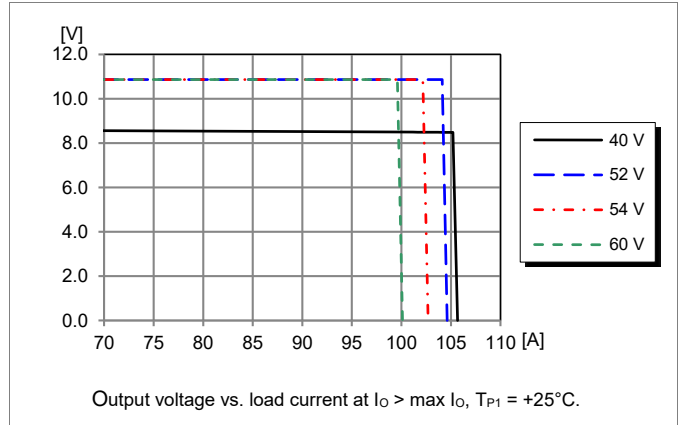

**Available Power**

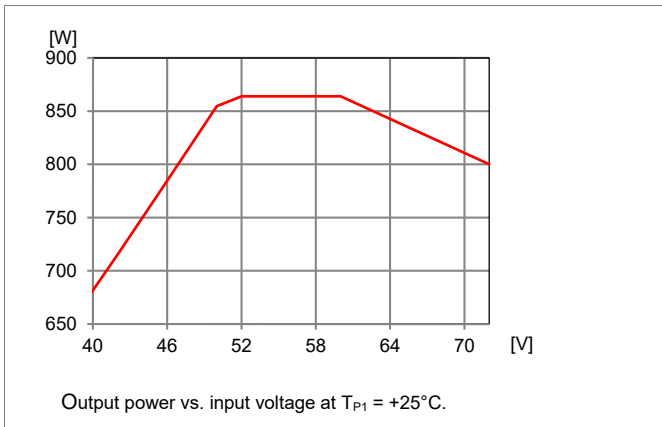

Technical Specification

**PKM4000NH series** Fully regulated Bus Converters  
 Input 40-60 V, Output up to 80 A / 864 W

1/28701-BMR669 Rev G      November 2017  
 © Flex

**Typical Characteristics**  
**10.8 V, 80 A / 864 W**

**PKM 4817 NH PIHS**

**Start-up**

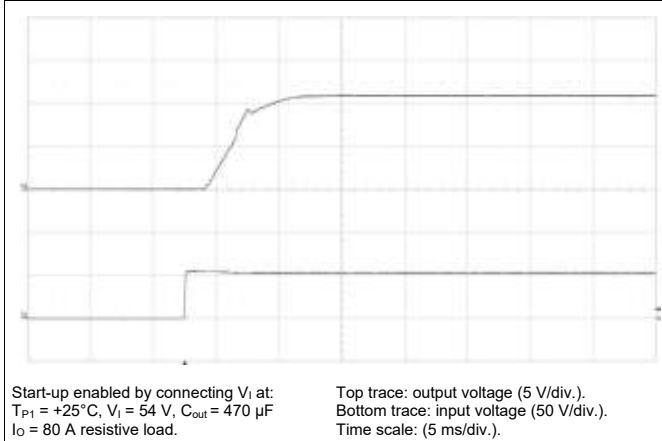

**Shut-down**

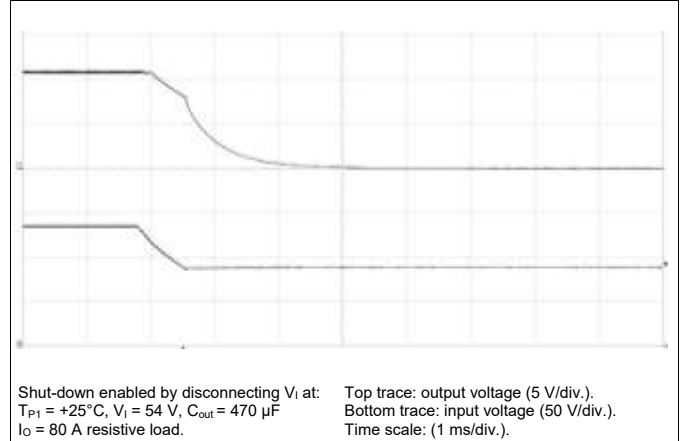

**Output Ripple & Noise**

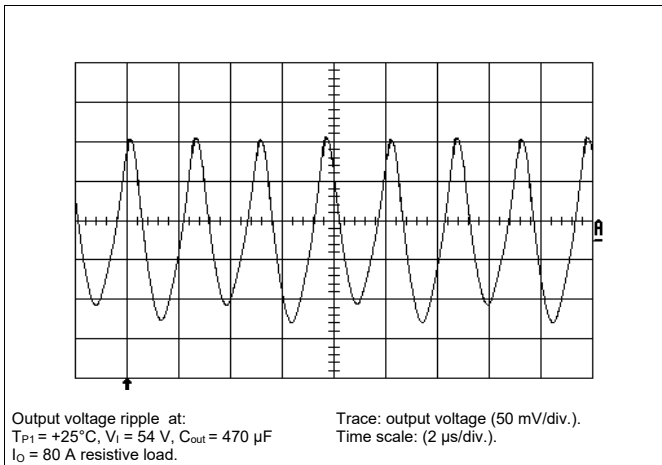

**Output Load Transient Response**

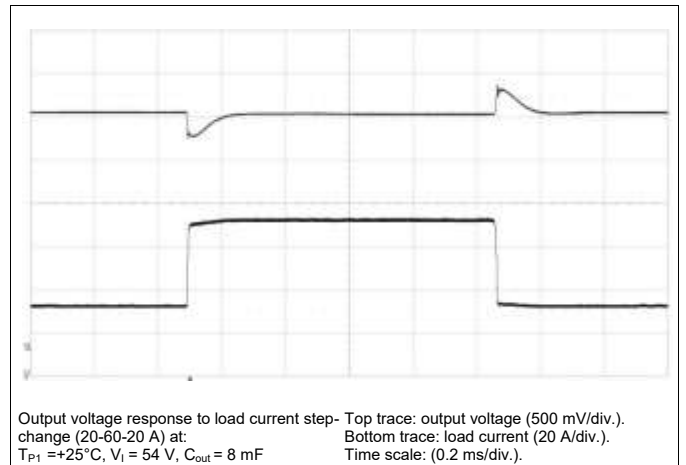

Technical Specification

**PKM4000NH series** Fully regulated Bus Converters  
 Input 40-60 V, Output up to 80 A / 864 W

1/28701-BMR669 Rev G November 2017  
 © Flex

**Typical Characteristics**  
**10.8 V, 80 A / 864 W**

**PKM 4817 NH PIHS**

**Output Power Derating – Base plate**

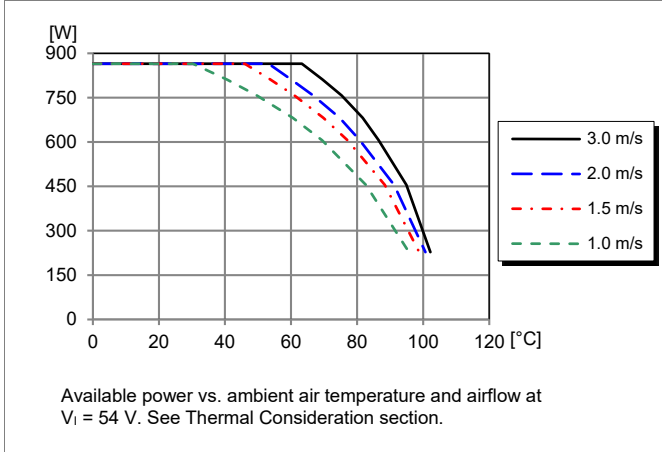

**Thermal Resistance – Base plate**

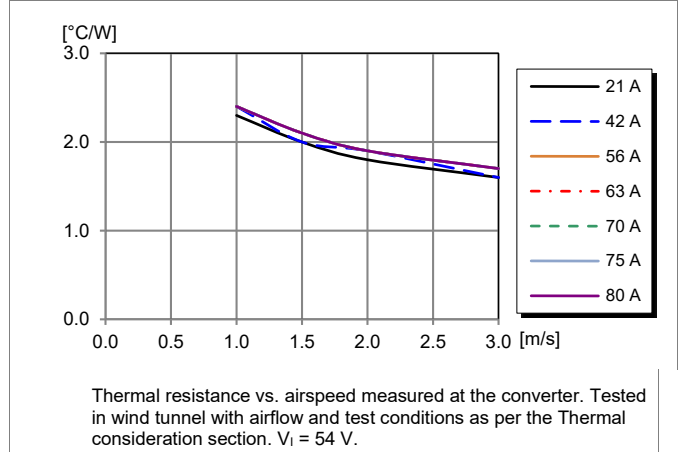

**Output Power Derating – Baseplate and 1/2" heat sink**

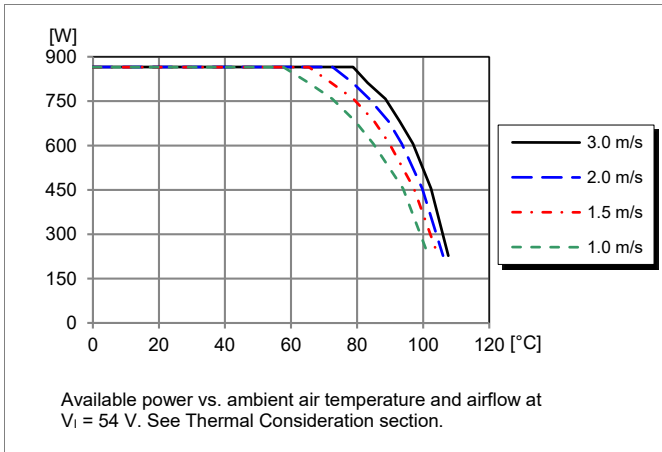

**Thermal Resistance – Baseplate and 1/2" heat sink**

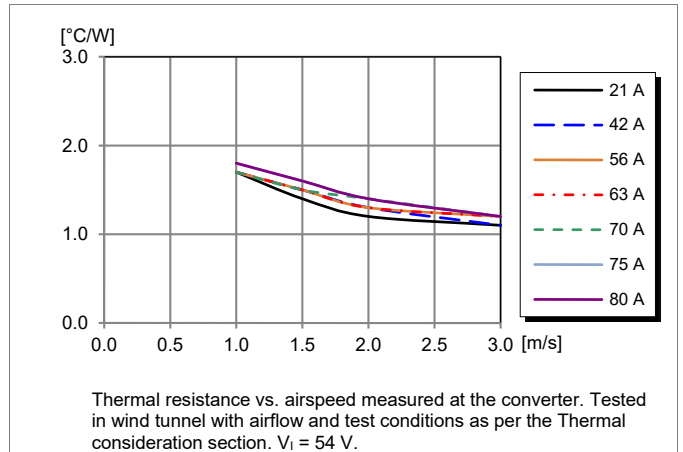

Technical Specification

**PKM4000NH series** Fully regulated Bus Converters  
 Input 40-60 V, Output up to 80 A / 864 W

1/28701-BMR669 Rev G November 2017  
 © Flex

**Typical Characteristics**  
**10.8 V, 80 A / 864 W**

**PKM 4817 NH PIHS**

**Output Power Derating – Different options @ 1.0 m/s**

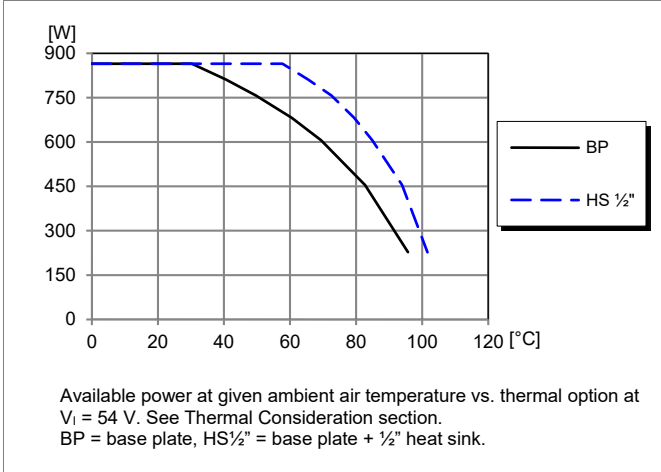

**Thermal Resistance – Different options @ 1.0 m/s**

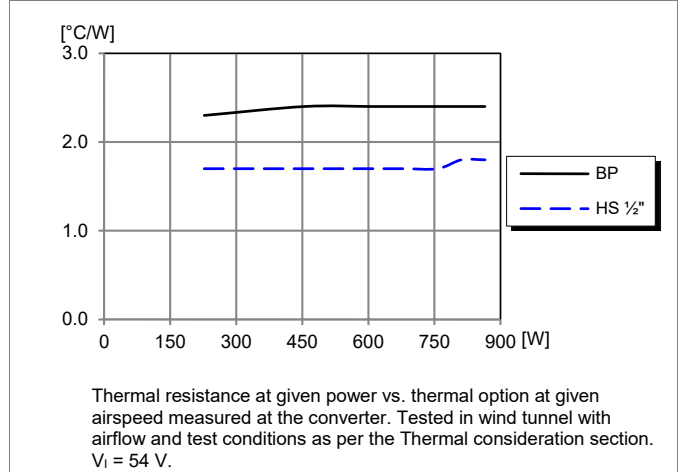

**Output Power Derating – Different options @ 1.5 m/s**

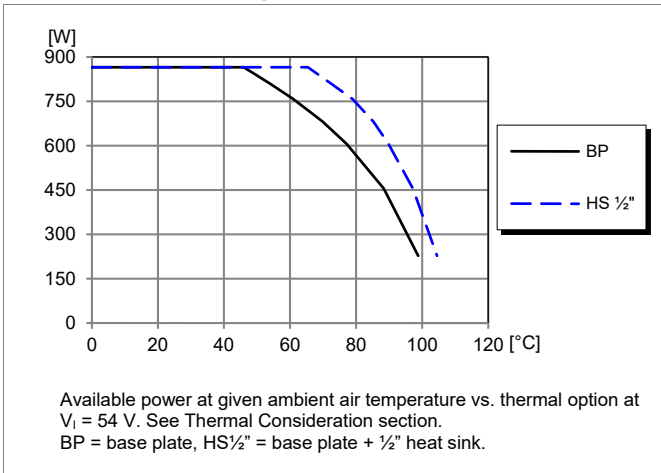

**Thermal Resistance – Different options @ 1.5 m/s**

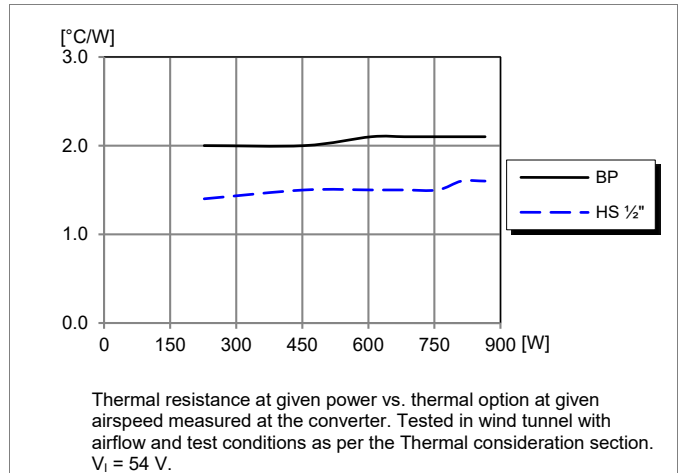

**Output Power Derating – Different options @ 2.0 m/s**

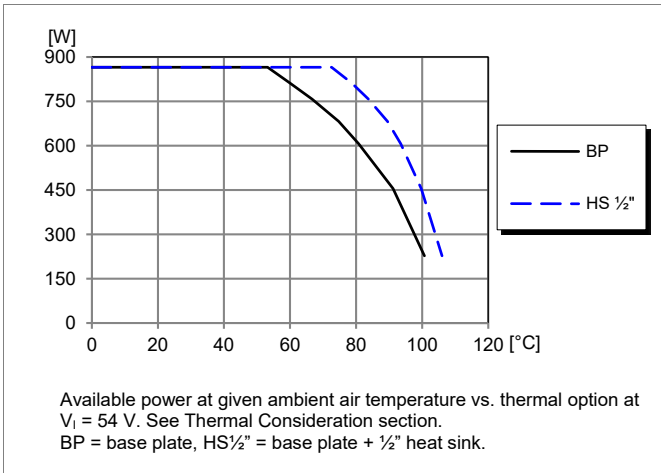

**Thermal Resistance – Different options @ 2.0 m/s**

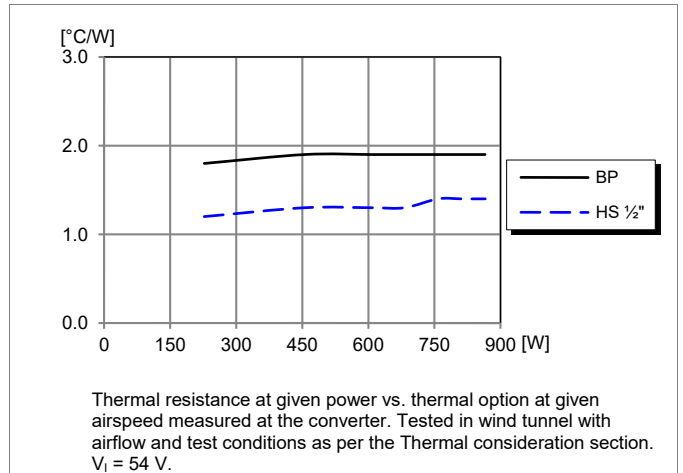



## Technical Specification

**PKM4000NH series** Fully regulated Bus Converters  
 Input 40-60 V, Output up to 80 A / 864 W

1/28701-BMR669 Rev G      November 2017  
 © Flex

### Typical Characteristics 10.8 V, 80 A / 864 W

### PKM 4817 NH PIHS

#### Output Power Derating – Different options @ 3.0 m/s

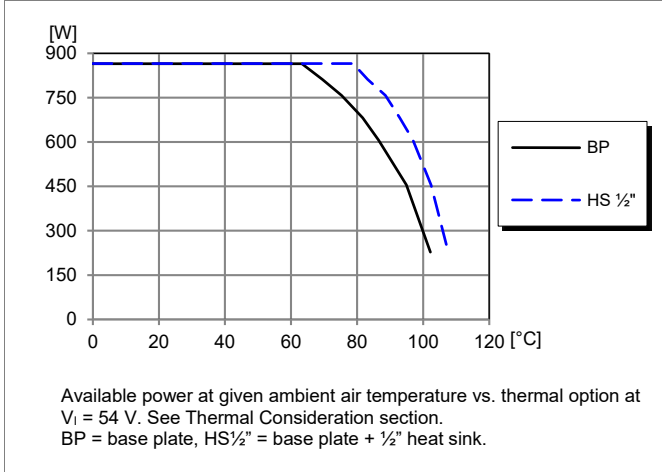

#### Thermal Resistance – Different options @ 3.0 m/s

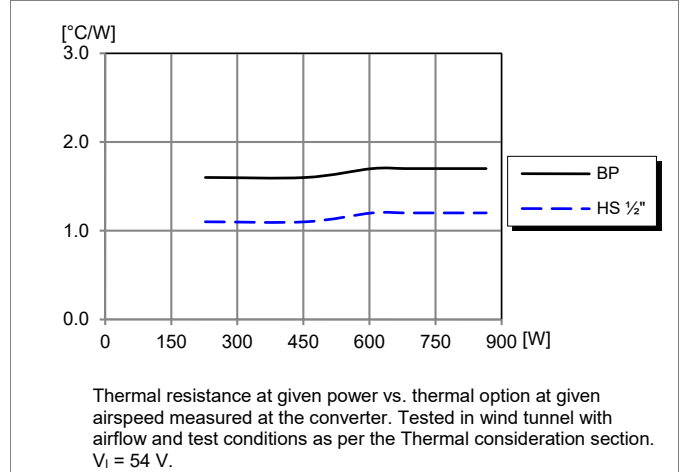

#### Output Current Derating – Cold wall sealed box

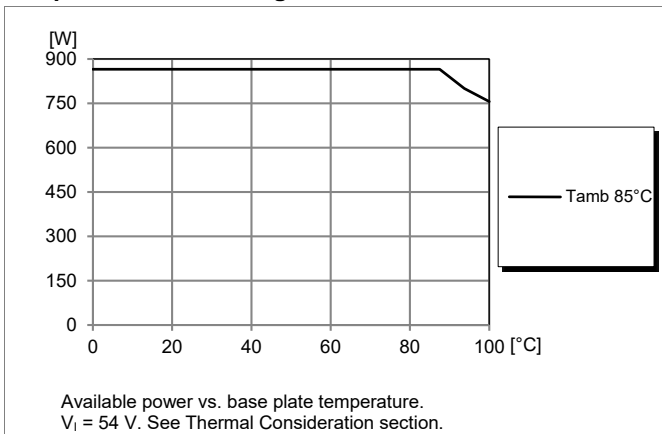

## Technical Specification

**PKM4000NH series** Fully regulated Bus Converters  
Input 40-60 V, Output up to 80 A / 864 W

1/28701-BMR669 Rev G November 2017

© Flex

EAB/FJB/GMF [Ksenia Harrisen]

(MICMALE)

2017-09-27

D

### EMC Specification

Conducted EMI measured according to EN55022, CISPR 22 and FCC part 15J (see test set-up). See Design Note 009 for further information. The fundamental ripple frequency is 400 kHz at  $V_i = 54$  V and max  $I_o$ .

#### Conducted EMI Input terminal value (typ)

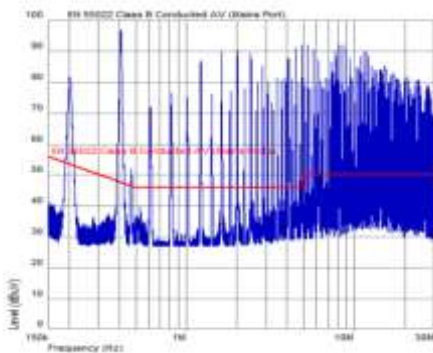

EMI without filter

#### Optional external filter for class B

Suggested external input filter in order to meet class B in EN 55022, CISPR 22 and FCC part 15J.

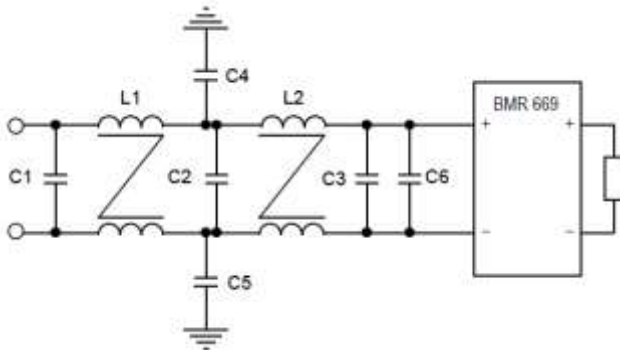

Filter components:

C1, C2, = 5  $\mu$ F

C3 = 15  $\mu$ F 100V; KRM55WR72A156MH01K (Murata)

C6 = 470  $\mu$ F 100 V; UPJ2A470MHD (Nichicon)

C4, C5 = 20 nF, 1500V

L1, L2 = 0.47mH

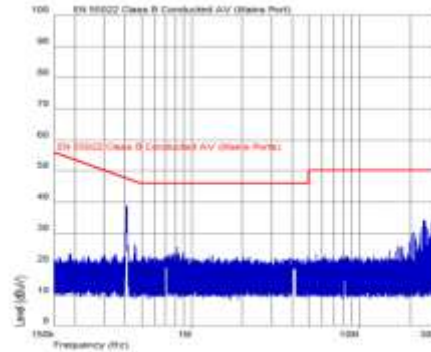

EMI with filter

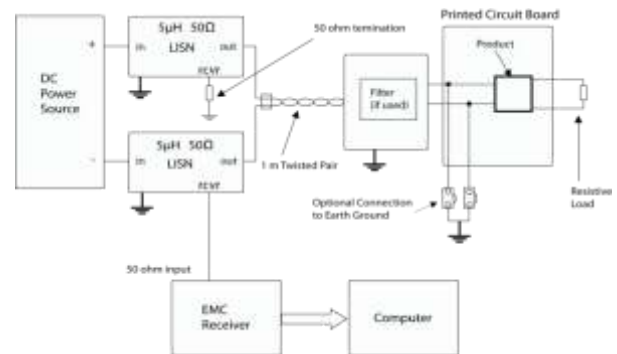

Test set-up

#### Layout recommendations

The radiated EMI performance of the product will depend on the PCB layout and ground layer design. It is also important to consider the stand-off of the product. If a ground layer is used, it should be connected to the output of the product and the equipment ground or chassis.

A ground layer will increase the stray capacitance in the PCB and improve the high frequency EMC performance.

Technical Specification

**PKM4000NH series Fully regulated Bus Converters**  
 Input 40-60 V, Output up to 80 A / 864 W

1/28701-BMR669 Rev G November 2017

© Flex

EAB/FJB/GMF [Ksenia Harrison]

(MICMALE)

2017-09-27

D

**Output ripple and noise**

Output ripple and noise measured according to figure below. See Design Note 022 for detailed information.

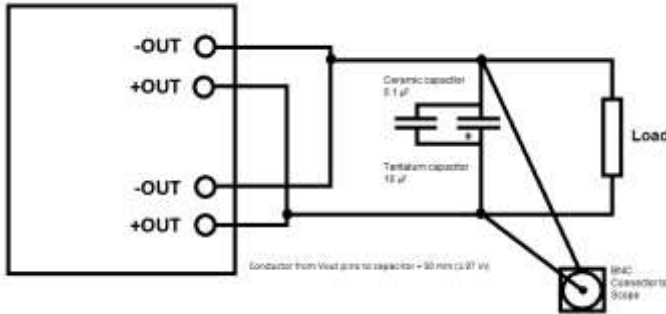

Output ripple and noise test setup

**Operating information**

**Product Overview**

The product is a crossover product that competes with the power-levels of a fixed-ratio or semi regulated product and with most of the features from a fully regulated DC/DC design still in place. It is a bus converter product family primarily intended to power down stream Point of Load products, PoL's.

**Input Voltage**

The long term operational input voltage range 40 to 60 Vdc meets the requirements of the European Telecom Standard ETS 300 132-2 for normal input voltage range in -48 Vdc systems -40.5 to -57.0 V and the transitional period -60 Vdc systems, -50.0 to -72.0 V with some degradation in power.

At input voltages exceeding 60 V, the power loss will be higher than at normal input voltage. There is a guard band to OCP, the product will not limit the output power itself above 60 V.  $T_{P1}$  must be limited to absolute max +125°C. The derated output power above 60 Vin is to maintain design rules regarding power dissipation and flux density due to increased ripple current. Trying to apply maximum load longer term may lead to the product going into Over Temperature Protection (OTP) and that the expected life time decreases. The absolute maximum continuous input voltage is 72 Vdc.

Operating in the 60-72 Vdc range the product is still fully regulated and keeps the output voltage but the higher input voltage increases the output voltage ripple. This input voltage range is intended to be used for limited periods such as in a boosted hold-up applications.

**Window of normal operations**

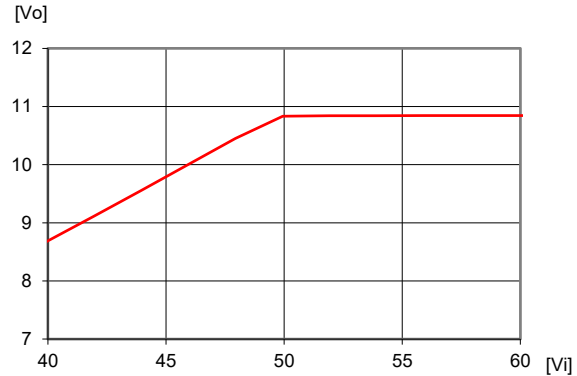

Between 50 and 60 Vin the product operates just like a normally regulated product. It handles load and line transients well and keeps a constant output voltage as well as a constant maximum power.

Below 50 Vin the output voltage starts to track the input voltage with a fixed proportion, keeping a duty-cycle guard band for regulation and runs all the way down to 40 Vin.

Maintaining Vout down to 36 Vin is possible; however input voltage below 40 Vin result in derated electrical and thermal performance.

**Available Power Graph**

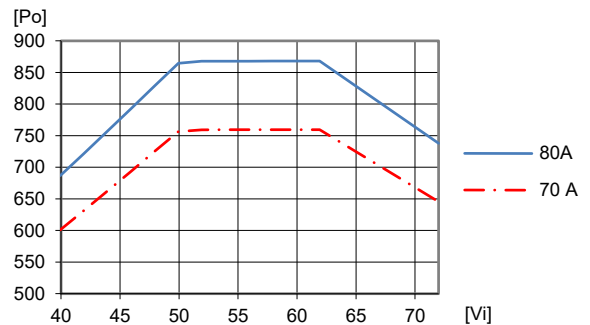

To enable a high power capability at low input voltages the input under voltage lockout is set to start the product when the input voltage reaches the typical value found in the Electrical Specification.

Technical Specification

<b>PKM4000NH series Fully regulated Bus Converters</b>		1/28701-BMR669 Rev G	November 2017
Input 40-60 V, Output up to 80 A / 864 W		© Flex	
EAB/FJB/GMF [Ksenia Harrison]	(MICMALE)	2017-09-27	D

**Input transient**

Short duration transient disturbances can occur on the DC distribution and input of the product when a short circuit fault occurs on the equipment side of a protective device (fuse or circuit breaker). The voltage level, duration and energy of the disturbance are dependent on the particular DC distribution network characteristics and can be sufficient to damage the product unless measures are taken to suppress or absorb this energy. The transient voltage can be limited by capacitors and other energy absorbing devices like transient voltage suppression diodes connected across the positive and negative input conductors at a number of strategic points in the distribution network. The end-user must secure that the transient voltage will not exceed the value stated in the Absolute maximum ratings. ETSI TR 100 283 examines the parameters of DC distribution networks and provides guidelines for controlling the transient and reduce its harmful effect.

**Turn-on/off Input Voltage**

The products monitor the input voltage and will turn on and turn off at predetermined levels that are stated in the Electrical Specification for the specific product. The minimum hysteresis between turn on and turn off input voltage is 3 V helps avoiding start-up oscillations and repeated restarts that could occur otherwise.

**Remote Control (RC)**

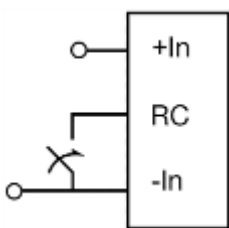

The products are fitted with a remote control function referenced to the primary negative input connection (-In), with negative and positive logic options available. The RC function allows the product to be turned on/off by an external device like a semiconductor, or a mechanical switch placed close to the product. The RC pin has an internal pull up resistor of 10 kΩ to +5 V. The threshold level has a hysteresis and the function is designed to be robust to noise.

The external device must provide a minimum required sink current to guarantee a voltage not higher than the maximum voltage on the RC pin (see Electrical characteristics table). When the RC pin is left open, the voltage generated on the RC pin is 5 V.

The standard product is provided with “negative logic” RC and will be off until the RC pin is connected to -In. To turn off the product the RC pin should be left open. To power up the product automatically, without the need for control signals or a switch, the RC pin can be wired directly to -In.

The second option is “positive logic” RC, which can be ordered by adding the suffix “P” to the end of the part number. When the RC pin is left open, the product starts up automatically when the input voltage is applied. Turn off is achieved by connecting the RC pin to -In. The product will restart automatically when this connection is opened.

The RC function incorporates a short delay in order to not trigger on glitches. Typically this filter has a settling time of 0.1-0.5 ms. This setup significantly reduces the risk for noise causing the converter to shutdown or power up accidentally.

See Design Note 021 for detailed information.

**Input and Output Impedance**

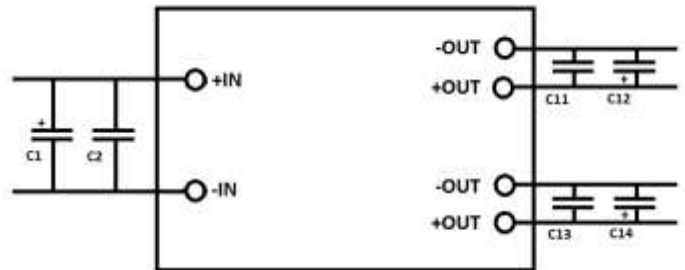

**Recommended de-coupling setup**

C1 = 470 μF 100 V; UPJ2A470MHD from Nichicon or similar.  
 C2 = 15 μF 100 V; KRM55WR72A156MH01K from Murata or similar close to the pins.  
 C11,C13 = 10 μF 16 V; GRM31CR71C106K from Murata or similar close to the pins.  
 C12,C14 = 470 μF 16 V; 16SEPC470M from Panasonic or similar in parallel with 1000 μF 16 V; UPJ1C102MHD from Nichicon or similar.

The components used in the recommended de-coupling setup are typical components and could be replaced with components from different manufacturers with similar characteristics. The ceramic capacitors will handle high frequency noise from switching and the OS-CON will secure de-coupling capacitance if  $T_{amb} < -10^{\circ}C$ .

The impedance of both the input source and the load will interact with the impedance of the product.

The application must be designed to meet the criteriaeas of both ESR and capacitance for all  $T_{amb}$  temperatures. This means that it may not be sufficient to mount a capacitor rated within the tolerances of minimum capacitance and ESR limits if these values derate due to temperature.

**Input Decoupling Capacitors**

It is important that the input source has low characteristic impedance. Recommended source impedance is below 100 mΩ over the  $T_{amb}$  temperature range or input oscillations may occur at start-up or at a high load current surge. Minimum external capacitance for the input is 470 μF if it is of the electrolytic type to cater for the impedance over the temperature range. Modern stacked ceramics provide high capacitance with low ESR over a wide range of temperatures and might be considered.

## Technical Specification

<b>PKM4000NH series Fully regulated Bus Converters</b>		1/28701-BMR669 Rev G	November 2017
Input 40-60 V, Output up to 80 A / 864 W		© Flex	
EAB/FJB/GMF [Ksenia Harrison]	(MICMALE)	2017-09-27	D

Recommended input capacitors connected in parallel as follows:

470  $\mu$ F 100 V; UPJ2A470MHD from Nichicon or similar, 15  $\mu$ F 100 V stacked ceramics; KRM55WR72A156MH01K from Murata or similar.

This means that the input capacitor value may need to be substantially larger than specified minimum capacitance, if the ESR of the impedance increase, to maintain a stable input at low temperatures.

### Output Decoupling Capacitors

When powering loads with significant dynamic current requirements, the voltage regulation at the point of load can be improved by addition of decoupling capacitors close to the load. The most effective technique is to locate very low ESR capacitors as close to the load as possible and, if needed, the bulk of capacitance with low ESR close to the converter output.

OS-CON type of capacitor has very low ESR and very good performance in both warm and cold conditions and therefore this type is recommended to place as near the point of load as possible for de-coupling the load.

Ceramic type of capacitor has also very low ESR and they are cheap in comparison to OS-CON. Drawbacks are derating due to bias voltage and temperature.

The use of very low ESR capacitors is restricted due to the high Q- value and stable operation is guaranteed with a verified ESR value of >10 m $\Omega$  across the output connections. If the application cannot guarantee the ESR condition it is possible to dampen the Q- value by adding an appropriate resistor in series with the capacitance or by mounting the very low ESR close to the point of load and thereby include the conductor resistance in the loop.

For ceramic capacitors it is not recommended to use more than 1 mF (rated capacitance) close to the converter output connections.

As an example it is not recommended to mount more than two (2) Panasonic SEPC 470  $\mu$ F 16 V (OS-CON) in parallel close to the converter output connections as using several parallel capacitors will lower the effective ESR.

The recommended type of capacitance to place near the converter output connections is a low ESR aluminium electrolyte in parallel with a ceramic capacitor according to the picture under "Input and Output Impedance". It is recommended that this type of capacitance is used as bulk in high capacitive load application. The aluminium electrolyte works well with the converter but it is important to choose proper temperature classification as this has impact on the expected life span. Cold conditions have great impact on ESR value for the aluminium electrolyte; if cold environment is expected this must be considered and a component with ESR rated for low temperatures is preferred to secure performance.

The ceramic capacitors will handle high-frequency dynamic load changes while the electrolytic capacitors are used to handle low frequency dynamic load changes. It is equally important to use low resistance and low inductance PCB layouts and cabling.

External decoupling capacitors will become part of the product's control loop. The control loop is optimized for a wide range of external capacitance and the maximum recommended value that could be used without any additional analysis is found in the Electrical Specification.

The end user must secure that the used capacitance is within specified limits described under External Decoupling Capacitors for all ambient temperatures as this highly impact ESR performance and capacitance.

Recommended output capacitors connected in parallel per output branch as follows:  
470  $\mu$ F 16 V; 16SEPC470M from Panasonic or similar, 1000  $\mu$ F 16 V; UPJ1C102MHD from Nichicon or similar.

For further information please contact your local Flex Power Modules representative.

### Hybrid Regulated Ratio (HRR)

The product uses two regulation modes. The regulated ratio mode let the regulator track the Vin with a fixed proportion, still with a guard band for load and transient regulation. The hybrid regulated mode swaps seamlessly from a ratio regulated mode to a normally regulated mode above a certain input voltage. See Output Characteristics in the Electrical Specification.

HRR uses a fast adaption system and a slow adaption system to react to both fast and slow input voltage changes to provide an input voltage feed-forward function. The fast adaption system prevents the converter to change output voltage very rapid. It filters sudden input voltage changes. The slow adaption system does not let fast input voltage transients through in the regulated ratio mode, it just slowly adapts to the new input voltage. When the input voltage changes the tracking system needs up to 3 ms to fully respond.

In the normally regulated mode the tracking will be saturated and the converter regulates towards a precision reference voltage instead making it almost unsusceptible to transients.

### Controlled low external output capacitor charge current at input voltage step

Due to the slow adaption system the HRR product efficiently reduces those charge currents for the external capacitors during an input voltage transient or level shift.

## Technical Specification

**PKM4000NH series Fully regulated Bus Converters**

Input 40-60 V, Output up to 80 A / 864 W

1/28701-BMR669 Rev G

November 2017

© Flex

EAB/FJB/GMF [Ksenia Harrison]

(MICMALE)

2017-09-27

D

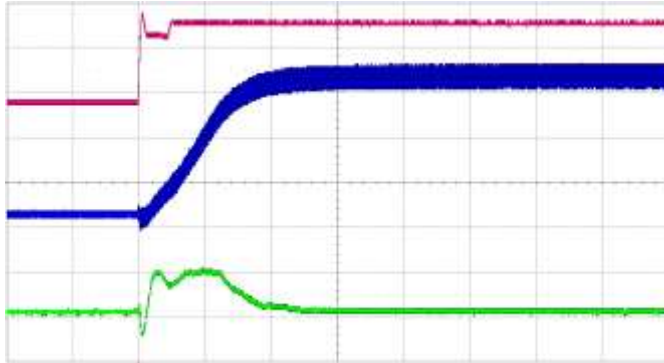

HRR product output at input transient voltage step 36-72 V, 1 ms/div  
 Red line – input voltage change 36-72 V, 20 V/div  
 Blue line – resulting output voltage change, 1 V/div  
 Green line – output current to Flex evaluation board ROA128 5077 R2A mounted with 7 pcs BMR464 0002/001 R3B in parallel operating as load, 10 A/div

**Input voltage transient suppression**

The hybrid regulated product suppress a 40-72 V input voltage transient down to less than 1 V above the regulated output, or only rising the output voltage to around 10.8 V if it is a voltage level shift and not just a transient.

With a HRR product a point-of-load converter does not have to be optimized for fast input voltage detection.

**Output Voltage**

The 10.8 V setpoint is chosen to match the efficiency “sweetspot” of PoL:s, while still provide very high power levels. 10.8 V will in most applications increase system efficiency over 12.0V Intermediate Bus Voltage.

In higher power, Adaptive Bus Voltage systems, at mid to high load, it shows that the system efficiency is best at approximately 8-11 V on the bus while the 11-13 V bus voltage provides the highest IBC power accompanied though with higher losses.

The DLS-products, see the Parallel Operation, Droop Load Share products-section, will have a slightly higher output voltage setpoint to be equal to the stand-alone product at full load.

Products with 12 and/or 12.45 V output voltage are planned within the family and will have slightly different performance and features compared to the 10.8 V-products.

**Parallel Operation, without Droop Load Share function**

Two or more products may be paralleled for redundancy if the total power is less than  $(n-1) \cdot P_{O\max}$ . External current sharing circuits must be used.

See Design Note 006 for detailed information.

**Over Temperature Protection (OTP)**

The products are protected from thermal overload by an internal over temperature shutdown circuit.

When  $T_{P1}$  as defined in thermal consideration section exceeds 140°C the product will shut down. The product will make continuous attempts to start (non-latching mode) and resumes normal operation when the temperature has dropped >10°C below the temperature threshold.

**Over Voltage Protection (OVP)**

The products have output over voltage protection that will shut down the product in over voltage conditions. The product will resume normal operation automatically after removal of the over voltage condition. The OVP setpoint can be found in the Electrical Specification.

The input over voltage protection will stop the switching and the output will be left as is when the converter reach the input voltage specified in the Electrical Specification. The converter will resume normal operation when  $V_{in}$  drop below the voltage specified in the Electrical Specification.

**Over Current Protection (OCP)**

The products include current limiting circuitry for protection at continuous overload. It is made up of one real-time (peak) current monitor that constitutes a power limiter and another part which detects longer overloads and enters a delayed hiccup. At output currents in excess of maximum output current ( $\max I_o$ ) the output voltage decrease towards zero and the current increase. If the overload persist the converter will after ~1.6 ms enter hiccup, disable the output and then make continuous restart attempts after a first timeout period, creating a delayed hiccup. The delay is set to a significantly longer time than the activation time (~200:1) in order to create low rms-currents in a fault condition. The timer and OCP setpoint are set to not trig on capacitive load during start-up, or cut-in during input voltage transients. The product will resume normal operation after removal of the overload. The load distribution should be designed for the maximum output OCP current specified in the Electrical Specification.

**Pre-bias Start-up**

The product has a Pre-bias start up functionality and will not sink current during start up if a Pre-bias source is present at the output terminals.

To guarantee a correct pre-bias start-up a minimum load of 20 mA is needed at any time output voltage is above 5V. When output voltage is above 5 V the start-up time will be dependent of load and capacitance. Typical applications with PoL's loading the module will generally provide the minimum loading to insure standard ramp rates for start-up.

At shutdown, OVP or OTP, the product will directly shut off the synchronous rectification to avoid reverse current.

The product will not start-up if the output voltage is higher than the OVP-level specified in the Electrical Specification.

**Soft Start**

The soft start function ramps up the output voltage. The main purpose is to control the charging current to the external output capacitors. The ramp-up is however pretty fast so there is a

## Technical Specification

**PKM4000NH series Fully regulated Bus Converters**  
Input 40-60 V, Output up to 80 A / 864 W

1/28701-BMR669 Rev G November 2017

© Flex

EAB/FJB/GMF [Ksenia Harrison]

(MICMALE)

2017-09-27

D

significant inrush current at the maximum capacitive load. The inrush current could lower the input rail, if the input impedance is too high. See the Input and Output impedance section. If the input voltage drops below 35 V the converter stops and makes new start-attempts when the input voltage bounces back up.

### Boosted hold-up applications

These products support hold up solutions with boosted hold-up capacitors that is hot-swapped to the input voltage rail at power-off of the original feed. Flex offers Power Input Module, PIM 4820B with such functionality.

If the input capacitance to the converter is small, the input voltage drops faster than 5 V/ms in the Regulated Ratio range below 45 V, the product will take some time to get back in regulated ratio mode again when the voltage returns and this leads to an overshoot. The smaller the input capacitor the higher the hot insertion point for the boosted capacitor should be. Use the range as close to the maximum input voltage, 72 V, as possible instead of just 60 V. A proper setting will result in a smooth output voltage without overshoot. Using too low input voltage cut-over levels might result in a slight overshoot at the output due to the longer adaption time in the regulated ratio mode (below 50 V). If a glitch is acceptable, it should be kept below the OVP activation level, typically 12.3 V.

PIM modules from Flex Power Modules shall be set to their highest set point, 44 V, and the boost level shall be adjusted to reach to 72 V in the application. I.e. the level needs to be adjusted to more than 72 V, approximately to 75 V. Consult the technical specification for the PIM-product regarding PIM-setting possibilities and features.

For further information please contact your local Flex Power Modules representative.

### Boosted Hold-up function; Idling

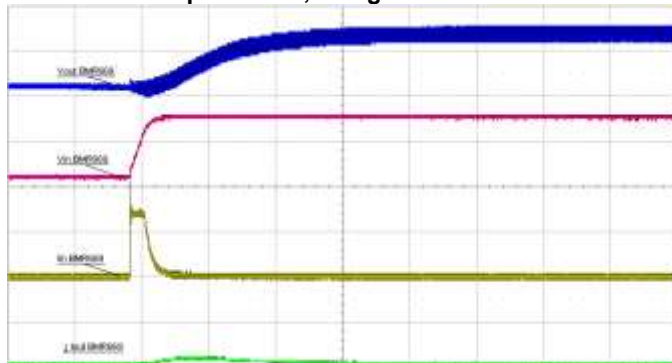

Blue line – output voltage 1 V/div

Red line – input voltage change 54-44-72 V, 20 V/div

Yellow line – input current supplied from the HU- capacitor, 50 A/div

Green line – output current, 50 A/div

2 ms/div

HRR product output at boosted hold up voltage step 54-44-72 V Flex evaluation board ROA 128 5151 R1A with HU capacitor 3x470  $\mu$ F+3300  $\mu$ F with a PIM 4820B PD R3A mounted on used as PIM.

HRR product decoupled with minimum recommended input and output capacitance specified in the Electrical Specification.

Flex evaluation board ROA 128 5077 R2A produce a rail with 7 pcs BMR 464 0002/001 R3B in parallel as current sharing an electrical load to represent a 0 W load for the HRR.

### Boosted Hold-up function; Po = 756 W

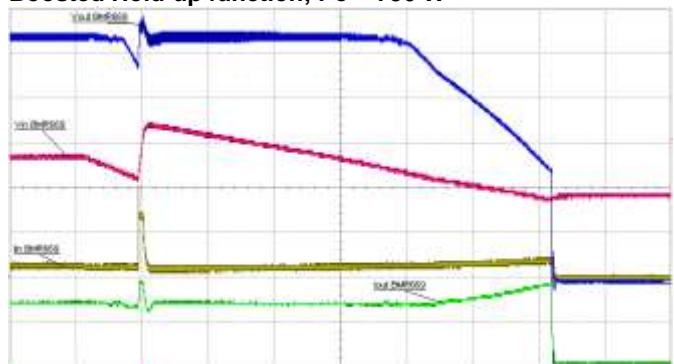

Blue line – output voltage peak at 11.3 V, 1 V/div

Red line – input voltage change 54-44-72 V, 20 V/div

Yellow line – input current supplied from the HU- capacitor, 50 A/div

Green line – output current, 50 A/div

2 ms/div

HRR product output at boosted hold up voltage step 54-44-72 V Flex evaluation board ROA 128 5151 R1A with HU capacitor 3x470  $\mu$ F+3300  $\mu$ F with a PIM 4820B PD R3A mounted on used as PIM.

HRR product decoupled with minimum recommended input and output capacitance specified in the Electrical Specification.

Flex evaluation board ROA 128 5077 R2A produce a rail with 7 pcs BMR 464 0002/001 R3B in parallel as current sharing an electrical load to represent a 756 W load for the HRR.

### Isolation

The open frame products have 2250 V input to output functional isolation. Leaving the baseplate free-floating means that the 2250 V input to output isolation voltage is kept.

Steady-state the voltage across the isolation barrier is not higher than the input voltage, maximum 60 V, and the output voltage together.

In order to keep the 2250 V functional isolation voltage between the product and the host board the keep away areas for components and traces must be followed according to the

## Technical Specification

**PKM4000NH series Fully regulated Bus Converters**  
 Input 40-60 V, Output up to 80 A / 864 W

1/28701-BMR669 Rev G November 2017

© Flex

EAB/FJB/GMF [Ksenia Harrison]

(MICMALE)

2017-09-27

D

Mechanical Information section or the clearance must be increased to at least 1.5 mm or insulated with approved isolation material according to the desired isolation voltage level. The minimum stand-off is 0.5 mm and the corresponding functional isolation voltage is 1500 V. See the Mechanical Information section for more information.

### Baseplate grounding

Variants with baseplate have the baseplate floating. The baseplate can be grounded externally via the threaded holes in the baseplate. In the latter case the isolation voltage is reduced and qualified values are stated in the Absolute Maximum Ratings.

Possibility to order variants with the baseplate grounded either to +In or –Out might be added to the program.

## Thermal Consideration

### General

The products are designed to operate in different thermal environments and sufficient cooling must be provided to ensure reliable operation. The converter needs some air flow, a baseplate or to be soldered to a host PCB to be operated even if just in idle mode.

For products mounted on a PCB without a heat sink attached, cooling is achieved mainly by conduction, from the pins to the host board, and convection, which is dependant on the airflow across the product. Increased airflow enhances the cooling of the product. The Output Power Derating graph found in the Typical Characteristics section for each model provides the available output power vs. ambient air temperature and air velocity at 54 Vin.

To enhance the thermal transfer the products are available with a baseplate as well as dual output pins. The products respond well on cooling methods due to its low internal thermal resistance.

### Convection cooling

The products power density is up to 580 W/cubic inch leaving a limited area for convection cooling and the heat generated is significant at high load. Just air flow is not sufficient for the product to deliver full power at high ambient temperatures.

In the section Typical characteristics, Output Power derating – Different cooling, the benefits of base plate and heat sink is clearly visualized. The absolute best performance can be obtained by using the highest heat sink possible that allows the most air to be forced through and thereby increase cooling.

### Conduction cooling

The thermal design is made to ease the transfer of heat from the product via both the input and the output power pins. The optional baseplate can be connected to a cold wall. See the Typical Characteristics section for graphs.

### Dual output pins

Products with dual output pins have from 2 and up to 20°C better thermal derating than single pin products.

As well as decreasing the power losses in the pins, dual pins will spread both the current and the heat better on the host board reducing the stress on the solder joints. For backward compability and designs using less than 500 W output power the single pin products can be used with up to 5 °C worse derating.

See Typical Characteristics section for more details.

### Layout considerations

Recommended host board footprint and plated through hole dimensions are defined by best practices to combine low resistance current/power distribution, standard mounting assembly techniques and relevant tolerances. When deviations in e.g. through plated hole sizes are applicable by end user, alternative techniques as wash away spacers, tailored fixtures or gap pads can be used by manufacturers to secure product form factor and functionality.

Inappropriate assembly techniques can stress the interconnection leads of the module and reduce the thermal coupling between e.g. the module's base plate and cold wall.

Special care should be paid to the current distribution flow within the host board by appropriate amount of copper layers/traces/interconnecting vias.

If the pins are connected to a plane in the host board this will become an efficient heat sink and significantly increase the maximum power before maximum temperature is reached. The outer layer on the host board should have a large number of vias close to the outside of the pins' shoulders in order to improve current and heat spreading between the host board and the product. The current and heat bottleneck is often close to the pin and it might be good to use extra PCB layers to connect to the pin and let the vias around the standoff spread the power to the power planes. For further information please contact your local Flex Power Modules representative.

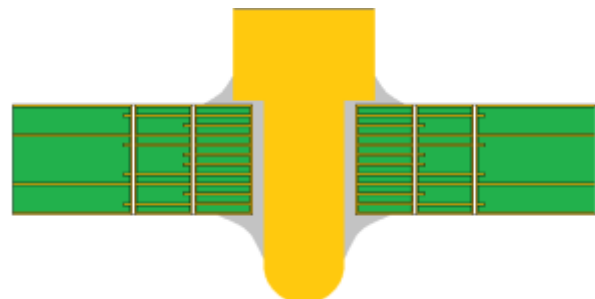



Technical Specification

**PKM4000NH series Fully regulated Bus Converters**  
 Input 40-60 V, Output up to 80 A / 864 W

1/28701-BMR669 Rev G November 2017

© Flex

EAB/FJB/GMF [Ksenia Harrison]

(MICMALE)

2017-09-27

D

**Baseplate**

The baseplate itself improves the performance by smoothening out the local hotspots on the converter. The other advantage is that it is an efficient way to dissipate heat from the product. Connected to a heatsink or a coldwall higher power can be delivered at high ambient temperatures. This also opens up for the use of advanced cooling technologies such as heatpipes or liquid cooling. See the Typical Characteristics section for graphs on different cooling and pinning options.

The product is tested on a 254 x 254 mm, 35 µm (1 oz), 16-layer test board mounted vertically in a wind tunnel with a cross-section of 608 x 203 mm.

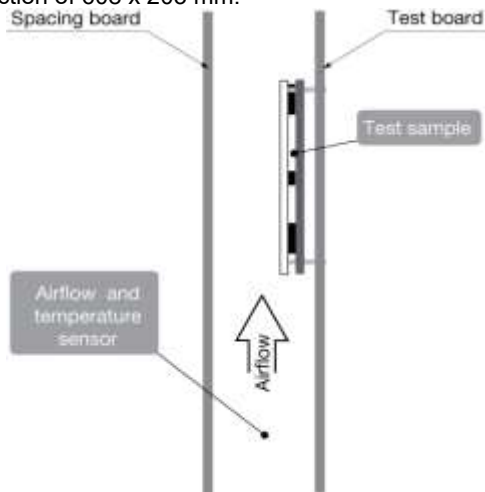

For products with base plate used in a sealed box/cold wall application, cooling is achieved mainly by conduction through the cold wall. The Output Current Derating graphs are found in the Output section for each model. The product is tested in a sealed box test set up with ambient temperatures 85°C at different output power conditions. See Design Note 028 for further details.

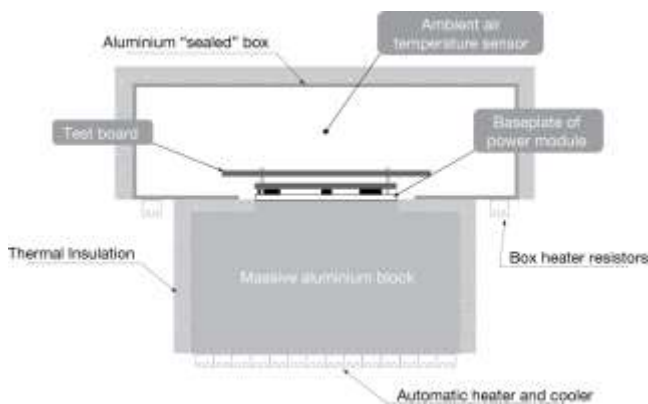

**Definition of product operating temperature**

The product operating temperatures is used to monitor the temperature of the product, and proper thermal conditions can be verified by measuring the temperature at positions P1, P2,

P3 and P4. The temperature at these positions ( $T_{P1}$ ,  $T_{P2}$ ,  $T_{P3}$ ,  $T_{P4}$ ) should not exceed the maximum temperatures in the table below. The number of measurement points may vary with different thermal design and topology. Temperatures above maximum  $T_{P1}$ ,  $T_{P2}$ ,  $T_{P3}$  and  $T_{P4}$ , measured at the reference points P1, P2, P3 and P4 are not allowed and may cause permanent damage.

Position	Description	Max Temp.
P1	Pcb prim	$T_{P1}=125^{\circ}\text{C}$
P2	M300	$T_{P2}=125^{\circ}\text{C}$
P3	T203	$T_{P3}=125^{\circ}\text{C}$
P4	N305	$T_{P4}=125^{\circ}\text{C}$

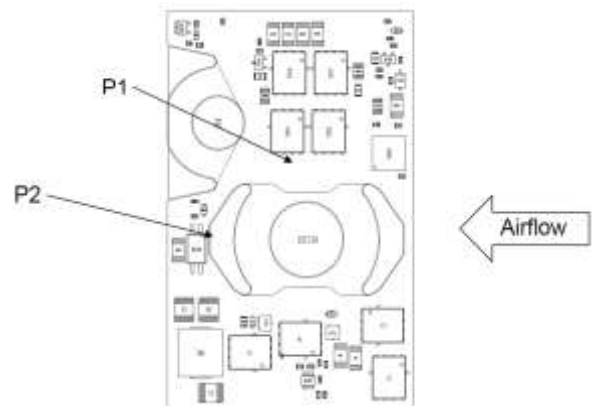

Open frame reference points

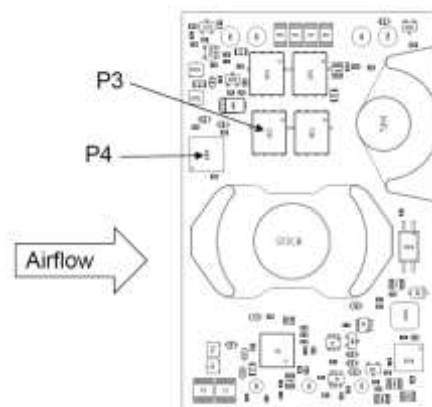

Reference points on a product equipped with a baseplate

**Ambient Temperature Calculation**

Technical Specification

**PKM4000NH series** Fully regulated Bus Converters  
 Input 40-60 V, Output up to 80 A / 864 W

1/28701-BMR669 Rev G November 2017  
 © Flex

EAB/FJB/GMF [Ksenia Harrison] (MICMALE) 2017-09-27 D

For products with baseplate the maximum allowed ambient temperature can be calculated by using the thermal resistance.

1. The power loss is calculated by using the formula

$$\left(\frac{1}{\eta} - 1\right) * \text{output power} = \text{power losses (Pd)}$$

$\eta$  = efficiency of product, e.g. 96.4% = 0.964

2. Find the thermal resistance (Rth) in the Thermal Resistance graph found in the Output section for each model. **Note that the thermal resistance can be significantly reduced if a heat sink is mounted on the top of the base plate.**

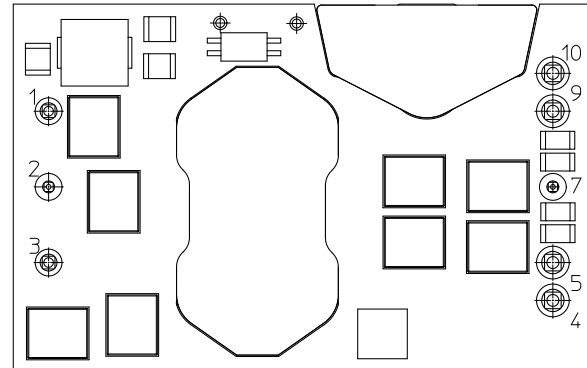

Calculate the temperature increase ( $\Delta T$ ).

$$\Delta T = R_{th} * P_d$$

3. Max allowed ambient temperature is:

$$\text{Max } T_{P1} - \Delta T.$$

E.g. PKM 4717NH PI, open frame at 1m/s:

$$1. \left(\frac{1}{0.964} - 1\right) * 756 W = 28.2 W$$

$$2. 28.2W * 2.9^\circ C/W = 81.8^\circ C$$

$$3. 125^\circ C - 81.8^\circ C = \text{max ambient temperature is } 43.2^\circ C$$

4. The thermal performance can be significantly improved by mounting a heat sink on top of the base plate.

The thermal resistance between base plate and heat sink,  $R_{th, b-h}$  is calculated as:

$$R_{th, b-h} = \frac{(T_{base\ plate} - T_{heat\ sink})}{R_{th}}$$

The actual temperature will be dependent on several factors such as the PCB size, number of layers and direction of airflow.

**Connections**

The picture shows the bottom view of the module.

Pin	Designation	Function
1	+In	Positive Input
2	RC	Remote Control
3	-In	Negative Input
4	+Out	Positive Output
5	-Out	Negative Output
7		Reserved
9	+Out	Positive output
10	-Out	Negative output

Optionally pins 4 and 10 can be omitted but for thermal reasons and optimal current distribution this is not recommended. See Typical Characteristics for thermal information.

Technical Specification

**PKM4000NH series Fully regulated Bus Converters**  
 Input 40-60 V, Output up to 80 A / 864 W

1/28701-BMR669 Rev G November 2017  
 © Flex

**Mechanical Information - Hole Mount, Open Frame Version**

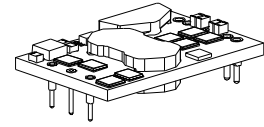
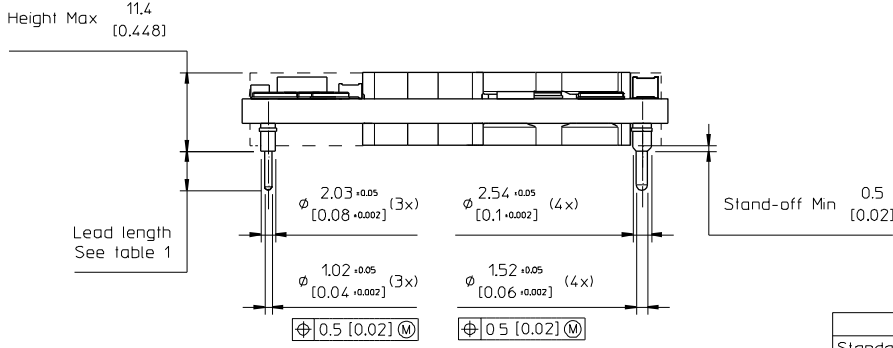

	Lead length
Standard	5.33 [0.210]
LA	3.69 [0.145]
LB	4.57 [0.180]
LC	2.79 [0.110]

Table 1

Pins  
 Pin 1, 3, 4, 5, 9 & 10 Material: Copper alloy  
 Pin 2 Material: Brass alloy  
 Pin positions 4 & 10 are optional  
 Plating: Min Au 0.1  $\mu\text{m}$  over 1-3  $\mu\text{m}$  Ni

Note 1: Recommended keep away area for user components to withstand input to output isolation voltage according to absolute maximum ratings.

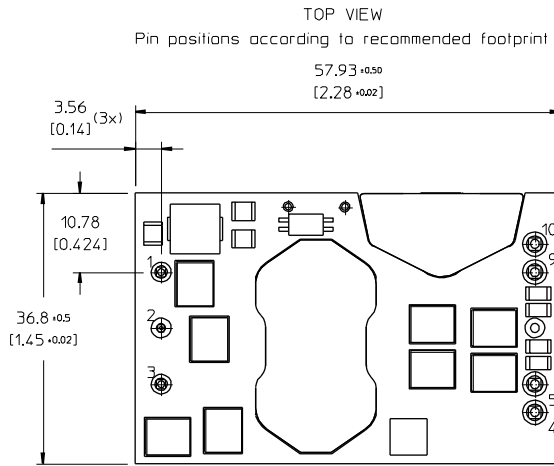

RECOMMENDED FOOTPRINT - TOP VIEW

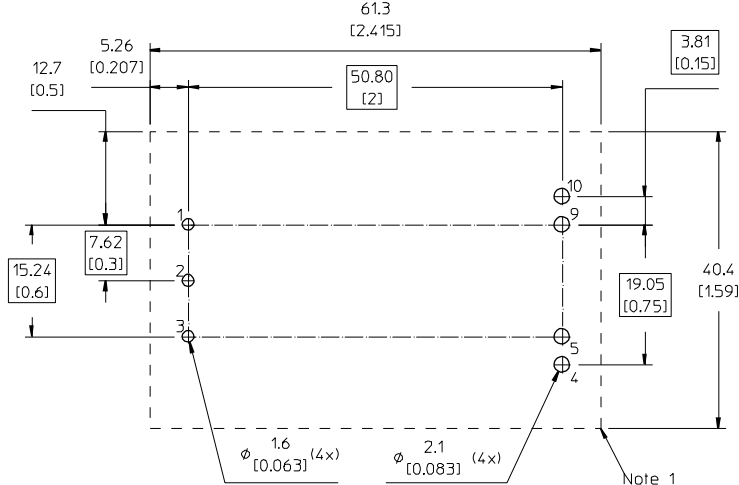

Weight: Typical 54 g  
 All dimensions in mm [inch].  
 Tolerances unless specified  
 x.x mm  $\pm 0.50$  mm [0.02]. x.xx mm  $\pm 0.25$  mm [0.01]  
 (not applied on footprint or typical values)

All component placements – whether shown as physical components or symbolical outline – are for reference only and are subject to change throughout the product's life cycle, unless explicitly described and dimensioned in this drawing.

Technical Specification

**PKM4000NH series Fully regulated Bus Converters**  
 Input 40-60 V, Output up to 80 A / 864 W

1/28701-BMR669 Rev G November 2017  
 © Flex

**Mechanical Information- Hole Mount, Base Plate Version**

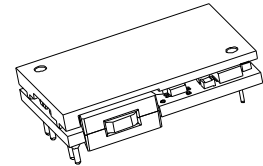
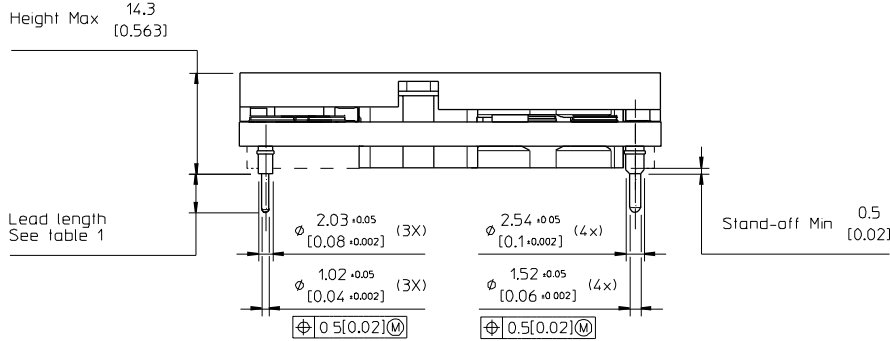

TOP VIEW

Pin positions according to recommended footprint

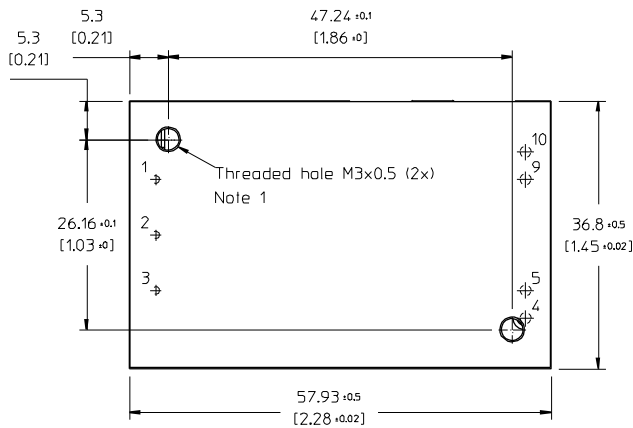

	Lead length
Standard	5.33 [0.210]
LA	3.69 [0.145]
LB	4.57 [0.180]
LC	2.79 [0.110]

Table 1

Case

Note 1: Material: Aluminium  
 For screw attachment apply mounting torque of max 0.44 Nm [3.9 lbf in].  
 M3 screws must not protrude more than 2.5 mm [0.1] into the base plate.

Pins

Pin 1, 3, 4, 5, 9 & 10 Material: Copper alloy  
 Pin 2 Material: Brass alloy  
 Pin positions 4 & 10 are optional  
 Plating: Min Au 0.1 µm over 1-3 µm Ni

Note 2: Recommended keep away area for user components to withstand input to output isolation voltage according to absolute maximum ratings.

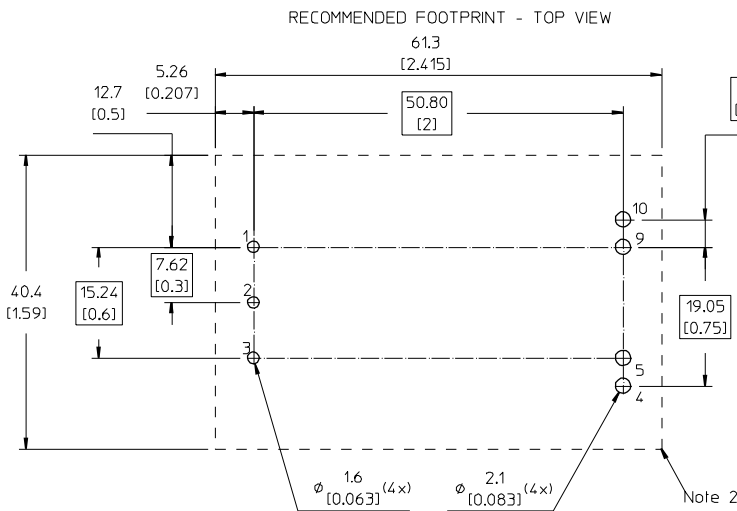

Weight: Typical 81 g

All dimensions in mm [inch].

Tolerances unless specified

x.x mm ±0.50 mm [0.02], x.xx mm ±0.25 mm [0.01]  
 (not applied on footprint or typical values)



Technical Specification

**PKM4000NH series Fully regulated Bus Converters**  
 Input 40-60 V, Output up to 80 A / 864 W

1/28701-BMR669 Rev G November 2017

© Flex

**Mechanical Information- Layout information**

Top view - Layout restrictions

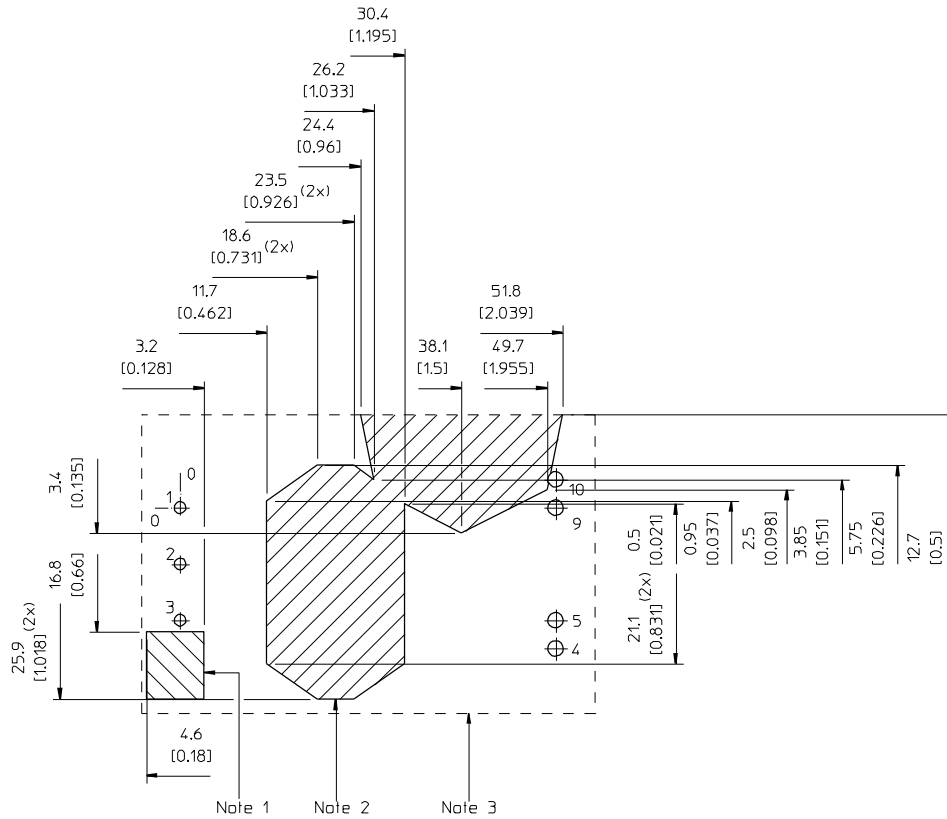

Keep away area criterion:  
 1.5mm [0.059"] safety clearance between input and output  
 circuitry acc. to IEC 60950-1, 2250V.  
 Assembly tolerances are included.  
 Note 1: Capacitors  
 Recommended keep away area for open vias/traces  
 connected to output circuitry to withstand input to  
 output isolation voltage according to absolute maximum ratings.  
 Note 2: Ferrite cores  
 Recommended keep away area for open vias/traces  
 connected to input circuitry to withstand input to  
 output isolation voltage according to absolute maximum ratings.  
 Note 3: Outline according to recommended footprint.

All dimensions in mm [inch].  
 Tolerances unless specified  
 x.x mm ±0.5 mm [0.02], x.xx mm ±0.25 mm [0.01]  
 (not applied on footprint or typical values)

Technical Specification

**PKM4000NH series Fully regulated Bus Converters**  
 Input 40-60 V, Output up to 80 A / 864 W

1/28701-BMR669 Rev G November 2017

© Flex

**Soldering Information - Hole Mounting**

The hole mounted product is intended for plated through hole mounting by wave or manual soldering. The pin temperature is specified to maximum to 270°C for maximum 10 seconds.

A maximum preheat rate of 4°C/s and maximum preheat temperature of 150°C is suggested. When soldering by hand, care should be taken to avoid direct contact between the hot soldering iron tip and the pins for more than a few seconds in order to prevent overheating.

A no-clean flux is recommended to avoid entrapment of cleaning fluids in cavities inside the product or between the product and the host board. The cleaning residues may affect long time reliability and isolation voltage.

**Delivery Package Information**

The products are delivered in antistatic trays.

Tray Specifications	
<b>Material</b>	Antistatic PE Foam
<b>Surface resistance</b>	$10^5 < \text{Ohm/square} < 10^{12}$
<b>Bakability</b>	The trays are not bakable
<b>Box capacity</b>	20 products (1 full tray/box)
<b>Tray weight</b>	Product – Open Frame Version 140 g empty, 1220 g full tray Product – Base Plate Version 140 g empty, 1760 g full tray

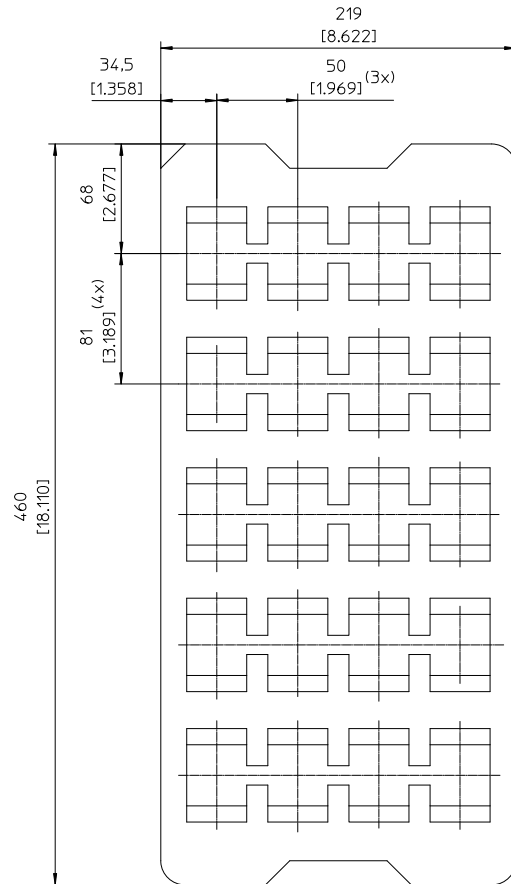

## Technical Specification

**PKM4000NH series Fully regulated Bus Converters**  
 Input 40-60 V, Output up to 80 A / 864 W

1/28701-BMR669 Rev G November 2017

© Flex

## Product Qualification Specification

Characteristics			
External visual inspection	IPC-A-610		
Change of temperature (Temperature cycling)	IEC 60068-2-14 Na	Temperature range Number of cycles Dwell/transfer time	-40 to 100°C 1000 15 min/0-1 min
Cold (in operation)	IEC 60068-2-1 Ad	Temperature T <sub>A</sub> Duration	-45°C 72 h
Damp heat	IEC 60068-2-67 Cy	Temperature Humidity Duration	85°C 85 % RH 1000 hours
Dry heat	IEC 60068-2-2 Bd	Temperature Duration	125°C 1000 h
Electrostatic discharge susceptibility	IEC 61340-3-1, JESD 22-A114 IEC 61340-3-2, JESD 22-A115	Human body model (HBM) Machine Model (MM)	Class 2, 2000 V Class 3, 200 V
Immersion in cleaning solvents	IEC 60068-2-45 XA, method 2	Water Glycol ether Isopropyl alcohol	55°C 35°C 35°C
Mechanical shock	IEC 60068-2-27 Ea	Peak acceleration Duration	100 g 6 ms
Moisture reflow sensitivity <sup>1</sup>	J-STD-020C	Level 1 (SnPb-eutectic) Level 3 (Pb Free)	225°C 260°C
Operational life test	MIL-STD-202G, method 108A	Duration	1000 h
Resistance to soldering heat <sup>2</sup>	IEC 60068-2-20 Tb, method 1A	Solder temperature Duration	270°C 10-13 s
Robustness of terminations	IEC 60068-2-21 Test Ua1 IEC 60068-2-21 Test Ue1	Through hole mount products Surface mount products	All leads All leads
Solderability	IEC 60068-2-58 test Td <sup>1</sup>	Preconditioning Temperature, SnPb Eutectic Temperature, Pb-free	150°C dry bake 16 h 215°C 235°C
	IEC 60068-2-20 test Ta <sup>2</sup>	Preconditioning Temperature, SnPb Eutectic Temperature, Pb-free	Steam ageing 235°C 245°C
Vibration, broad band random	IEC 60068-2-64 Fh, method 1	Frequency Spectral density Duration	10 to 500 Hz 0.07 g <sup>2</sup> /Hz 10 min in each direction

## Notes

<sup>1</sup> Only for products intended for reflow soldering (surface mount products)

<sup>2</sup> Only for products intended for wave soldering (plated through hole products)