

Order Code	TCK-113
Inductance (each winding)	806 $\mu\text{H} \pm 35\%$ (at 100 kHz / 100 mV)
Impedance (DCR)	25 mOhm max.
Rated Current	5.7 A max.
Rated Voltage	500 VDC max. (between windings)
Operating Temperature	-40°C to +105°C

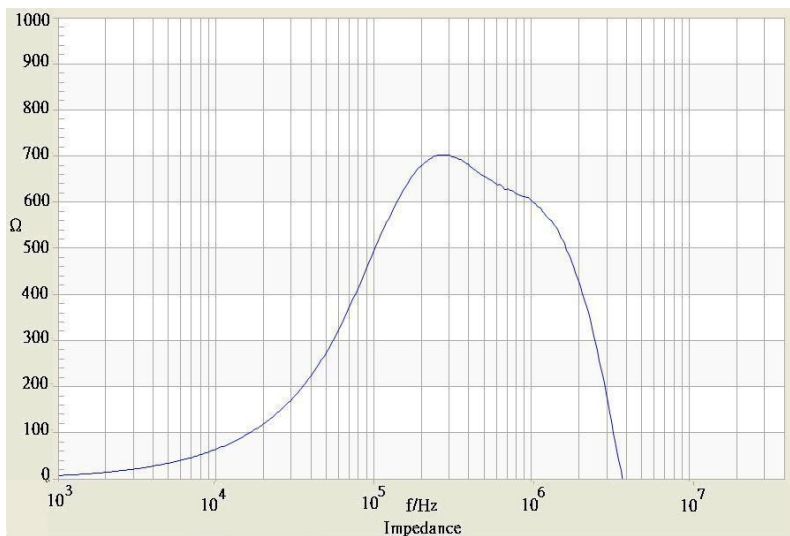

Impedance Curve



Outline Dimensions

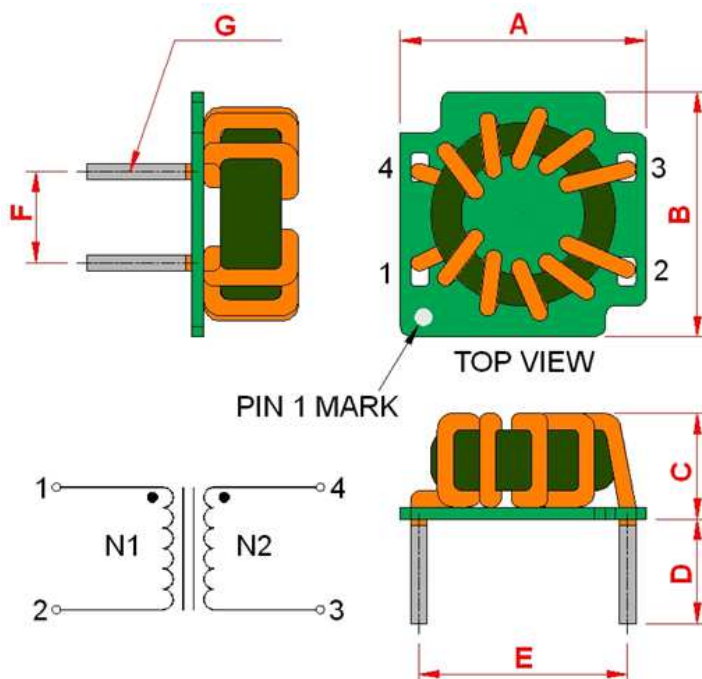

Dimensions [mm]

A	16.6 ±0.4
B	16.4 ±0.4
C	12.5 max.
D	5.0 ±1.0
E	14.5 ±0.5
F	6.1 ±0.5
G	∅ 0.7 max.