

ON Semiconductor

Is Now

onsemi™

To learn more about onsemi™, please visit our website at
www.onsemi.com

onsemi and **onsemi** and other names, marks, and brands are registered and/or common law trademarks of Semiconductor Components Industries, LLC dba "**onsemi**" or its affiliates and/or subsidiaries in the United States and/or other countries. **onsemi** owns the rights to a number of patents, trademarks, copyrights, trade secrets, and other intellectual property. A listing of **onsemi** product/patent coverage may be accessed at www.onsemi.com/site/pdf/Patent-Marking.pdf. **onsemi** reserves the right to make changes at any time to any products or information herein, without notice. The information herein is provided "as-is" and **onsemi** makes no warranty, representation or guarantee regarding the accuracy of the information, product features, availability, functionality, or suitability of its products for any particular purpose, nor does **onsemi** assume any liability arising out of the application or use of any product or circuit, and specifically disclaims any and all liability, including without limitation special, consequential or incidental damages. Buyer is responsible for its products and applications using **onsemi** products, including compliance with all laws, regulations and safety requirements or standards, regardless of any support or applications information provided by **onsemi**. "Typical" parameters which may be provided in **onsemi** data sheets and/or specifications can and do vary in different applications and actual performance may vary over time. All operating parameters, including "Typicals" must be validated for each customer application by customer's technical experts. **onsemi** does not convey any license under any of its intellectual property rights nor the rights of others. **onsemi** products are not designed, intended, or authorized for use as a critical component in life support systems or any FDA Class 3 medical devices or medical devices with a same or similar classification in a foreign jurisdiction or any devices intended for implantation in the human body. Should Buyer purchase or use **onsemi** products for any such unintended or unauthorized application, Buyer shall indemnify and hold **onsemi** and its officers, employees, subsidiaries, affiliates, and distributors harmless against all claims, costs, damages, and expenses, and reasonable attorney fees arising out of, directly or indirectly, any claim of personal injury or death associated with such unintended or unauthorized use, even if such claim alleges that **onsemi** was negligent regarding the design or manufacture of the part. **onsemi** is an Equal Opportunity/Affirmative Action Employer. This literature is subject to all applicable copyright laws and is not for resale in any manner. Other names and brands may be claimed as the property of others.

NPN - 2N6515, 2N6517; PNP - 2N6520

High Voltage Transistors NPN and PNP

Features

- Voltage and Current are Negative for PNP Transistors
- These are Pb-Free Devices*

MAXIMUM RATINGS

Rating	Symbol	Value	Unit
Collector – Emitter Voltage 2N6515 2N6517, 2N6520	V_{CEO}	250 350	Vdc
Collector – Base Voltage 2N6515 2N6517, 2N6520	V_{CBO}	250 350	Vdc
Emitter – Base Voltage 2N6515, 2N6517 2N6520	V_{EBO}	6.0 5.0	Vdc
Base Current	I_B	250	mAdc
Collector Current – Continuous	I_C	500	mAdc
Total Device Dissipation @ $T_A = 25^\circ\text{C}$ Derate above 25°C	P_D	625 5.0	mW mW/ $^\circ\text{C}$
Total Device Dissipation @ $T_C = 25^\circ\text{C}$ Derate above 25°C	P_D	1.5 12	W mW/ $^\circ\text{C}$
Operating and Storage Junction Temperature Range	T_J, T_{stg}	-55 to +150	$^\circ\text{C}$

THERMAL CHARACTERISTICS

Characteristic	Symbol	Max	Unit
Thermal Resistance, Junction-to-Ambient	$R_{\theta JA}$	200	$^\circ\text{C}/\text{W}$
Thermal Resistance, Junction-to-Case	$R_{\theta JC}$	83.3	$^\circ\text{C}/\text{W}$

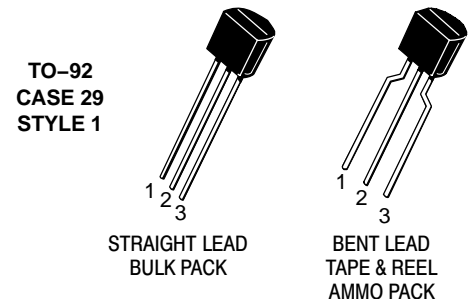
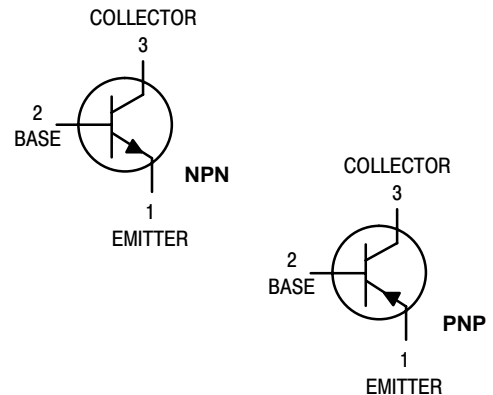
Stresses exceeding Maximum Ratings may damage the device. Maximum Ratings are stress ratings only. Functional operation above the Recommended Operating Conditions is not implied. Extended exposure to stresses above the Recommended Operating Conditions may affect device reliability.

*For additional information on our Pb-Free strategy and soldering details, please download the ON Semiconductor Soldering and Mounting Techniques Reference Manual, SOLDERRM/D.

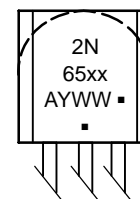


ON Semiconductor®

<http://onsemi.com>



MARKING DIAGRAM



xx = 15, 17, or 20
A = Assembly Location
Y = Year
WW = Work Week
▪ = Pb-Free Package

(Note: Microdot may be in either location)

ORDERING INFORMATION

See detailed ordering and shipping information in the package dimensions section on page 6 of this data sheet.

NPN – 2N6515, 2N6517; PNP – 2N6520

ELECTRICAL CHARACTERISTICS (T_A = 25°C unless otherwise noted)

Characteristic	Symbol	Min	Max	Unit	
OFF CHARACTERISTICS					
Collector–Emitter Breakdown Voltage (Note 1) (I _C = 1.0 mA _{dc} , I _B = 0)	2N6515 2N6517, 2N6520	V _{(BR)CEO}	250 350	– –	V _{dc}
Collector–Base Breakdown Voltage (I _C = 100 μA _{dc} , I _E = 0)	2N6515 2N6517, 2N6520	V _{(BR)CBO}	250 350	– –	V _{dc}
Emitter–Base Breakdown Voltage (I _E = 10 μA _{dc} , I _C = 0)	2N6515, 2N6517 2N6520	V _{(BR)EBO}	6.0 5.0	– –	V _{dc}
Collector Cutoff Current (V _{CB} = 150 V _{dc} , I _E = 0) (V _{CB} = 250 V _{dc} , I _E = 0)	2N6515 2N6517, 2N6520	I _{CBO}	– –	50 50	nA _{dc}
Emitter Cutoff Current (V _{EB} = 5.0 V _{dc} , I _C = 0) (V _{EB} = 4.0 V _{dc} , I _C = 0)	2N6515, 2N6517 2N6520	I _{EBO}	– –	50 50	nA _{dc}

ON CHARACTERISTICS (Note 1)

DC Current Gain (I _C = 1.0 mA _{dc} , V _{CE} = 10 V _{dc})	2N6515 2N6517, 2N6520	h _{FE}	35 20	– –	–
(I _C = 10 mA _{dc} , V _{CE} = 10 V _{dc})	2N6515 2N6517, 2N6520		50 30	– –	
(I _C = 30 mA _{dc} , V _{CE} = 10 V _{dc})	2N6515 2N6517, 2N6520		50 30	300 200	
(I _C = 50 mA _{dc} , V _{CE} = 10 V _{dc})	2N6515 2N6517, 2N6520		45 20	220 200	
(I _C = 100 mA _{dc} , V _{CE} = 10 V _{dc})	2N6515 2N6517, 2N6520		25 15	– –	
Collector–Emitter Saturation Voltage (I _C = 10 mA _{dc} , I _B = 1.0 mA _{dc}) (I _C = 20 mA _{dc} , I _B = 2.0 mA _{dc}) (I _C = 30 mA _{dc} , I _B = 3.0 mA _{dc}) (I _C = 50 mA _{dc} , I _B = 5.0 mA _{dc})		V _{CE(sat)}	– – – –	0.30 0.35 0.50 1.0	V _{dc}
Base–Emitter Saturation Voltage (I _C = 10 mA _{dc} , I _B = 1.0 mA _{dc}) (I _C = 20 mA _{dc} , I _B = 2.0 mA _{dc}) (I _C = 30 mA _{dc} , I _B = 3.0 mA _{dc})		V _{BE(sat)}	– – –	0.75 0.85 0.90	V _{dc}
Base–Emitter On Voltage (I _C = 100 mA _{dc} , V _{CE} = 10 V _{dc})		V _{BE(on)}	–	2.0	V _{dc}

SMALL-SIGNAL CHARACTERISTICS

Current–Gain – Bandwidth Product (Note 1) (I _C = 10 mA _{dc} , V _{CE} = 20 V _{dc} , f = 20 MHz)		f _T	40	200	MHz
Collector–Base Capacitance (V _{CB} = 20 V _{dc} , I _E = 0, f = 1.0 MHz)		C _{cb}	–	6.0	pF
Emitter–Base Capacitance (V _{EB} = 0.5 V _{dc} , I _C = 0, f = 1.0 MHz)	2N6515, 2N6517 2N6520	C _{eb}	– –	80 100	pF

SWITCHING CHARACTERISTICS

Turn–On Time (V _{CC} = 100 V _{dc} , V _{BE(off)} = 2.0 V _{dc} , I _C = 50 mA _{dc} , I _{B1} = 10 mA _{dc})		t _{on}	–	200	μs
Turn–Off Time (V _{CC} = 100 V _{dc} , I _C = 50 mA _{dc} , I _{B1} = I _{B2} = 10 mA _{dc})		t _{off}	–	3.5	μs

1. Pulse Test: Pulse Width ≤ 300 μs, Duty Cycle ≤ 2.0%.

NPN – 2N6515, 2N6517; PNP – 2N6520

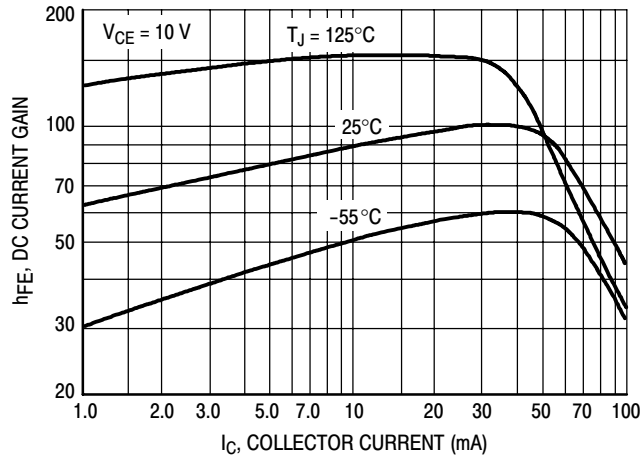


Figure 1. DC Current Gain
NPN 2N6515

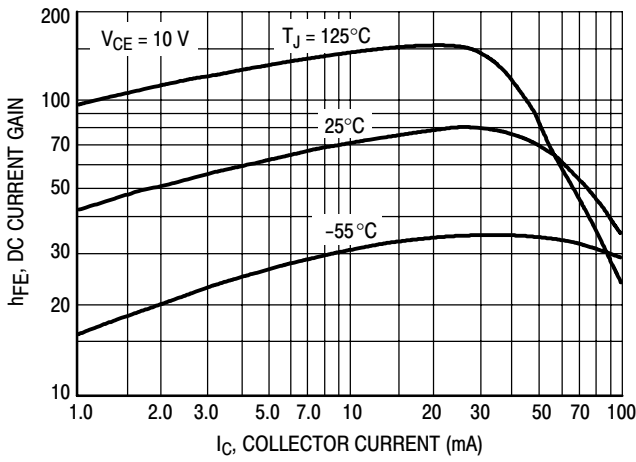


Figure 2. DC Current Gain
NPN 2N6517

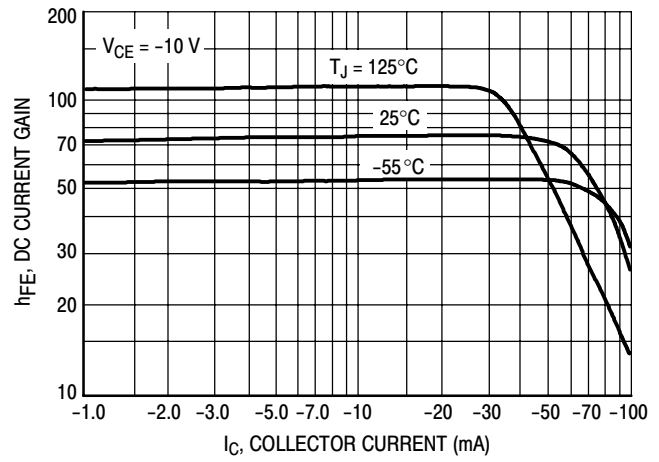


Figure 3. DC Current Gain
PNP 2N6520

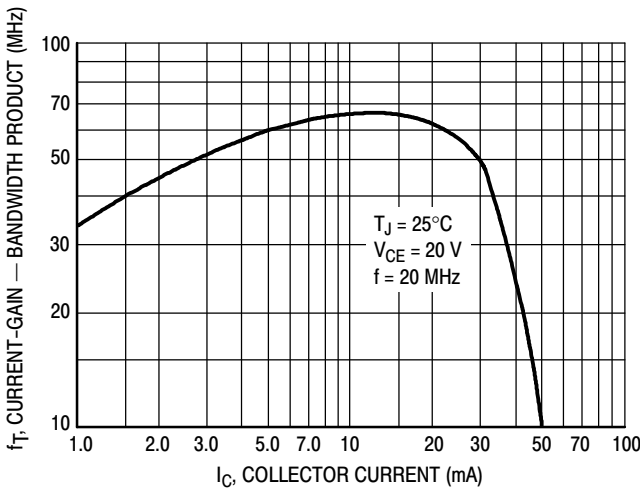


Figure 4. Current-Gain – Bandwidth Product
NPN 2N6515, 2N6517

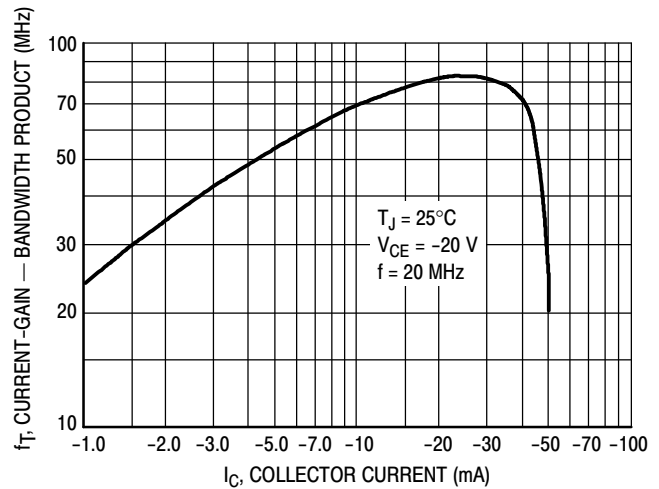
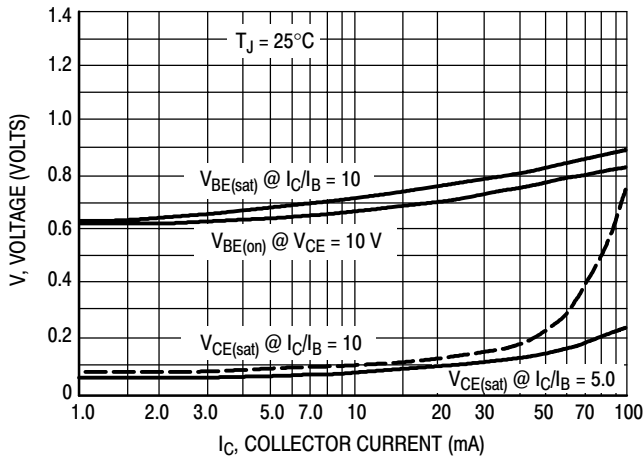
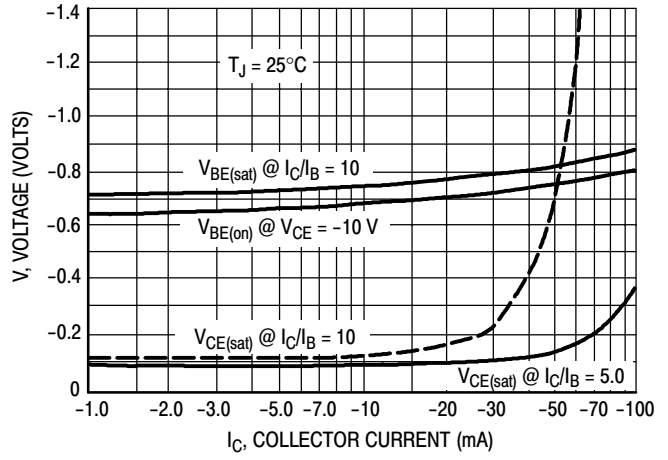


Figure 5. Current-Gain – Bandwidth Product
PNP 2N6520

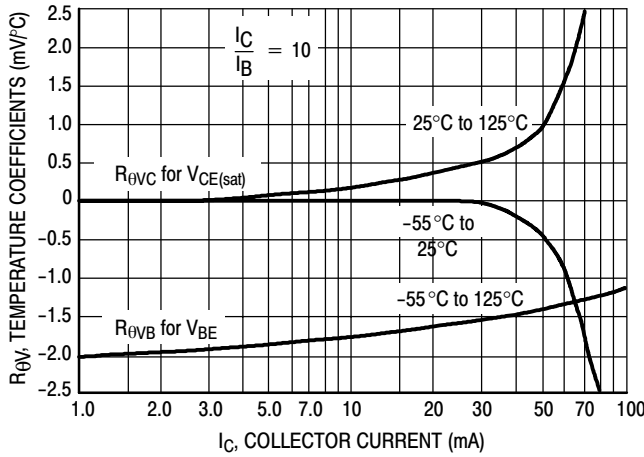
NPN – 2N6515, 2N6517; PNP – 2N6520



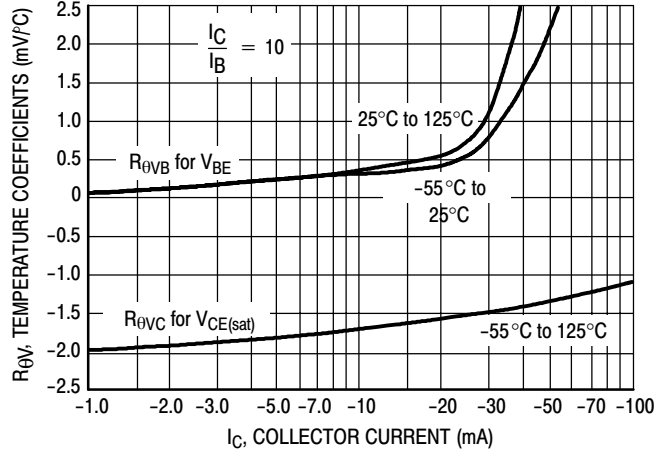
**Figure 6. "On" Voltages
NPN 2N6515, 2N6517**



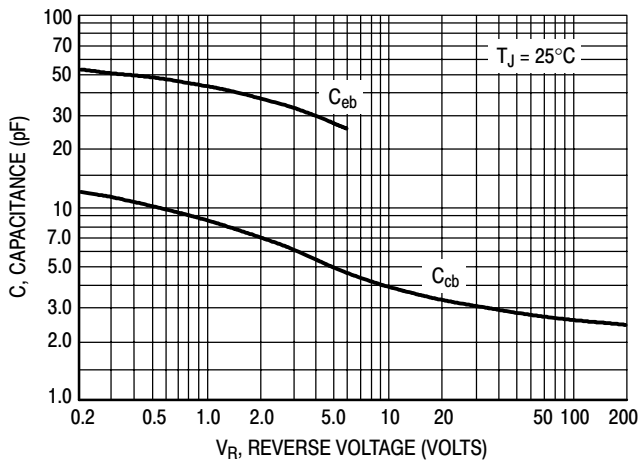
**Figure 7. "On" Voltages
PNP 2N6520**



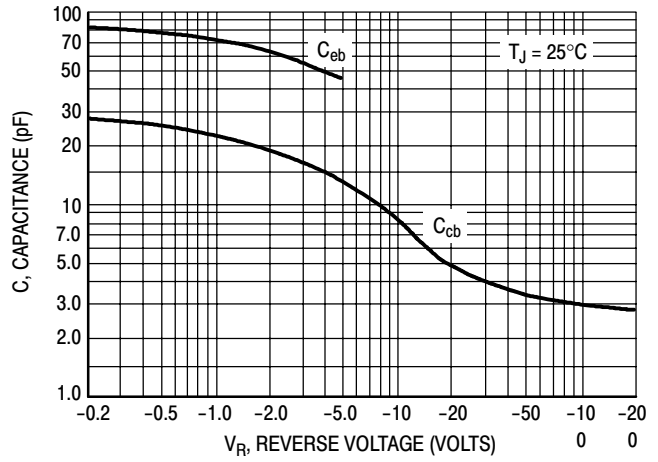
**Figure 8. Temperature Coefficients
NPN 2N6515, 2N6517**



**Figure 9. Temperature Coefficients
PNP 2N6520**

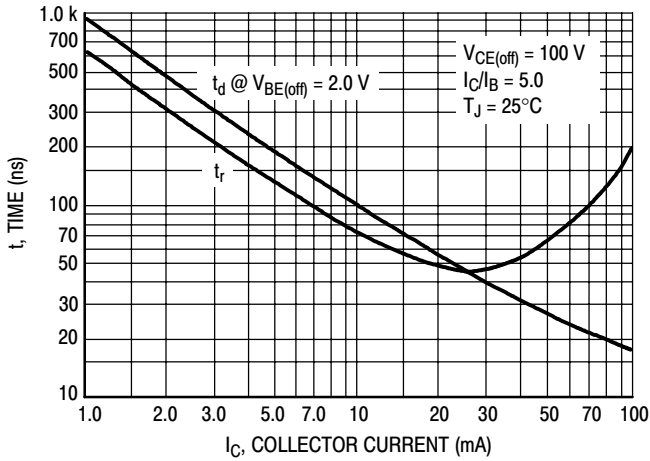


**Figure 10. Capacitance
NPN 2N6515, 2N6517**

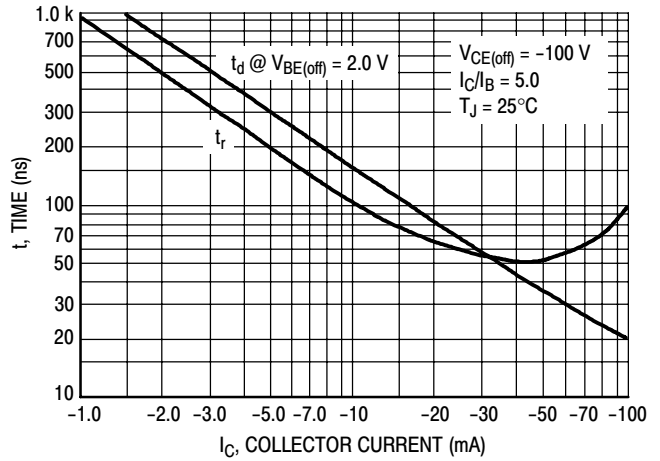


**Figure 11. Capacitance
PNP 2N6520**

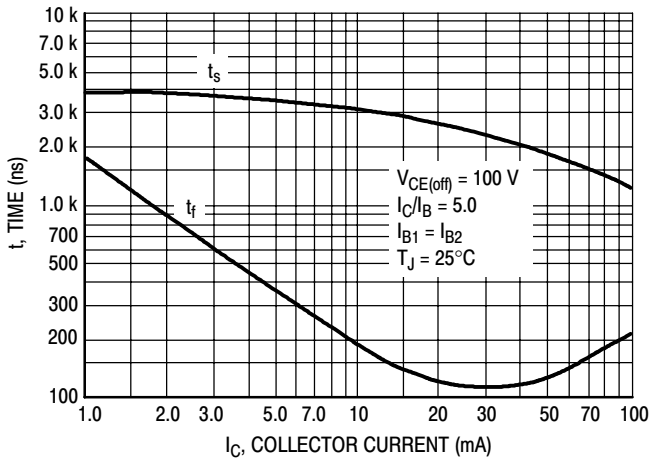
NPN – 2N6515, 2N6517; PNP – 2N6520



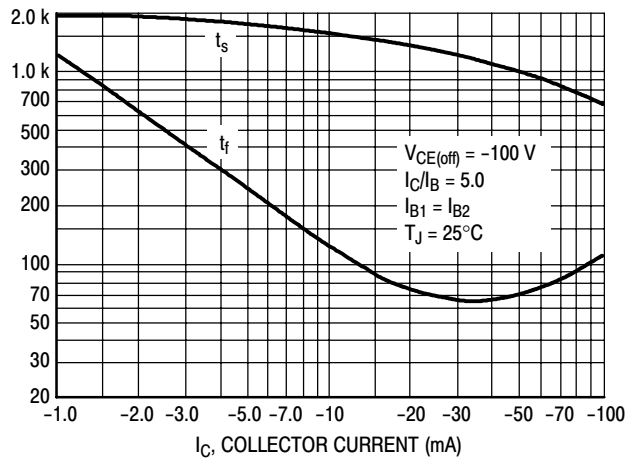
**Figure 12. Turn-On Time
NPN 2N6515, 2N6517**



**Figure 13. Turn-On Time
PNP 2N6520**



**Figure 14. Turn-Off Time
NPN 2N6515, 2N6517**



**Figure 15. Turn-Off Time
PNP 2N6520**

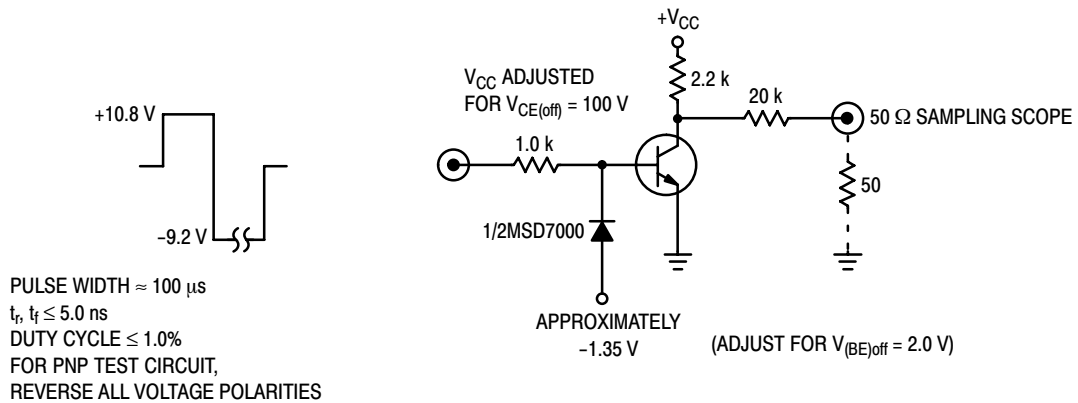


Figure 16. Switching Time Test Circuit

NPN – 2N6515, 2N6517; PNP – 2N6520

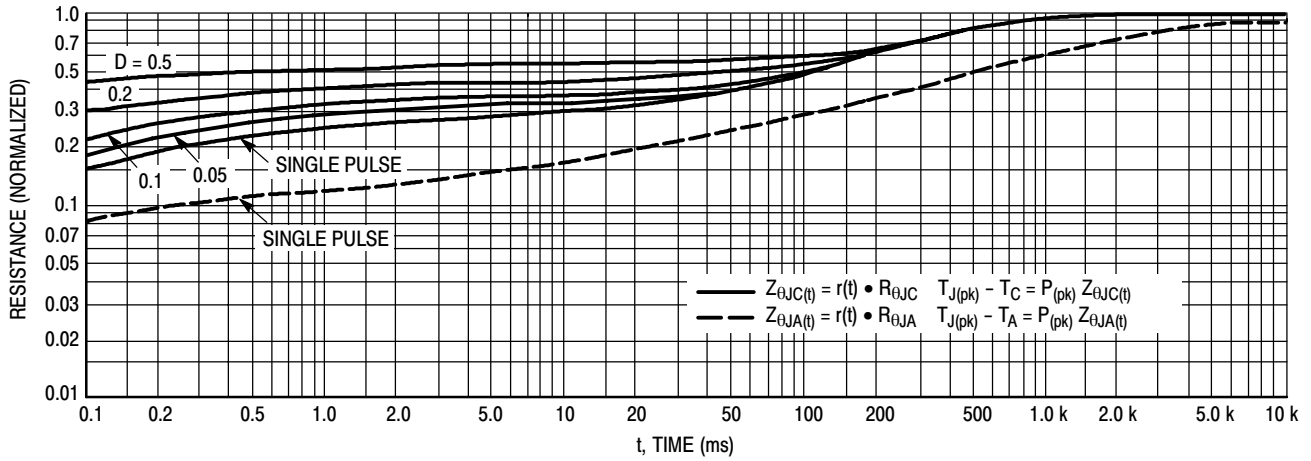


Figure 17. Thermal Response

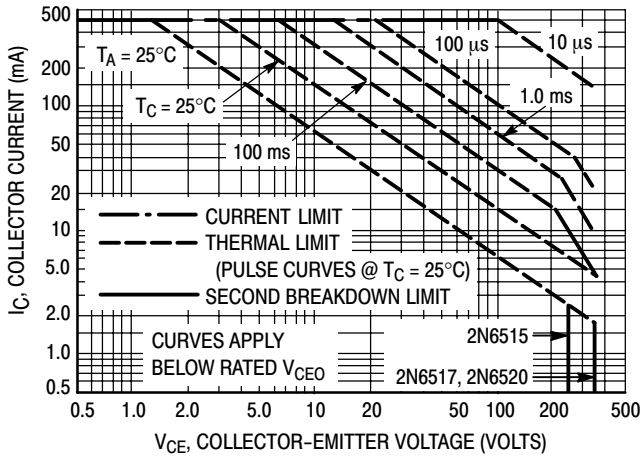
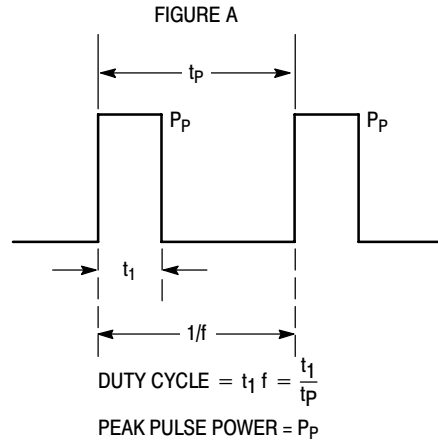


Figure 18. Active Region Safe Operating Area



Design Note: Use of Transient Thermal Resistance Data

ORDERING INFORMATION

Device	Package	Shipping†
2N6515RLRMG	TO-92 (Pb-Free)	2000 Ammo Pack
2N6517G	TO-92 (Pb-Free)	5000 Unit / Bulk
2N6517RLRPG	TO-92 (Pb-Free)	2000 Ammo Pack
2N6520RLRAG	TO-92 (Pb-Free)	2000 Tape & Reel

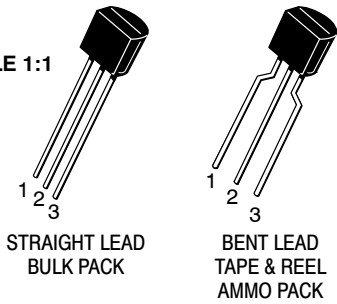
†For information on tape and reel specifications, including part orientation and tape sizes, please refer to our Tape and Reel Packaging Specifications Brochure, BRD8011/D.

MECHANICAL CASE OUTLINE PACKAGE DIMENSIONS

ON Semiconductor®

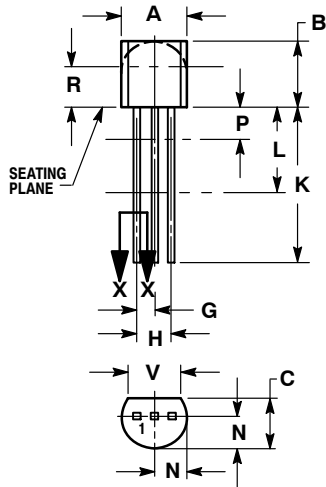


SCALE 1:1

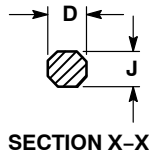


TO-92 (TO-226)
CASE 29-11
ISSUE AM

DATE 09 MAR 2007



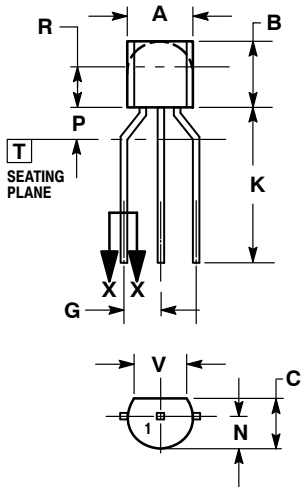
STRAIGHT LEAD
BULK PACK



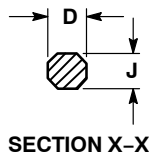
NOTES:

1. DIMENSIONING AND TOLERANCING PER ANSI Y14.5M, 1982.
2. CONTROLLING DIMENSION: INCH.
3. CONTOUR OF PACKAGE BEYOND DIMENSION R IS UNCONTROLLED.
4. LEAD DIMENSION IS UNCONTROLLED IN P AND BEYOND DIMENSION K MINIMUM.

DIM	INCHES		MILLIMETERS	
	MIN	MAX	MIN	MAX
A	0.175	0.205	4.45	5.20
B	0.170	0.210	4.32	5.33
C	0.125	0.165	3.18	4.19
D	0.016	0.021	0.407	0.533
G	0.045	0.055	1.15	1.39
H	0.095	0.105	2.42	2.66
J	0.015	0.020	0.39	0.50
K	0.500	---	12.70	---
L	0.250	---	6.35	---
N	0.080	0.105	2.04	2.66
P	---	0.100	---	2.54
R	0.115	---	2.93	---
V	0.135	---	3.43	---



BENT LEAD
TAPE & REEL
AMMO PACK



NOTES:

1. DIMENSIONING AND TOLERANCING PER ASME Y14.5M, 1994.
2. CONTROLLING DIMENSION: MILLIMETERS.
3. CONTOUR OF PACKAGE BEYOND DIMENSION R IS UNCONTROLLED.
4. LEAD DIMENSION IS UNCONTROLLED IN P AND BEYOND DIMENSION K MINIMUM.

DIM	MILLIMETERS	
	MIN	MAX
A	4.45	5.20
B	4.32	5.33
C	3.18	4.19
D	0.40	0.54
G	2.40	2.80
J	0.39	0.50
K	12.70	---
N	2.04	2.66
P	1.50	4.00
R	2.93	---
V	3.43	---

STYLES ON PAGE 2

DOCUMENT NUMBER:	98ASB42022B	Electronic versions are uncontrolled except when accessed directly from the Document Repository. Printed versions are uncontrolled except when stamped "CONTROLLED COPY" in red.
STATUS:	ON SEMICONDUCTOR STANDARD	
NEW STANDARD:		
DESCRIPTION:	TO-92 (TO-226)	PAGE 1 OF 3

TO-92 (TO-226)
CASE 29-11
ISSUE AM

DATE 09 MAR 2007

STYLE 1:
 PIN 1. EMITTER
 2. BASE
 3. COLLECTOR

STYLE 2:
 PIN 1. BASE
 2. EMITTER
 3. COLLECTOR

STYLE 3:
 PIN 1. ANODE
 2. ANODE
 3. CATHODE

STYLE 4:
 PIN 1. CATHODE
 2. CATHODE
 3. ANODE

STYLE 5:
 PIN 1. DRAIN
 2. SOURCE
 3. GATE

STYLE 6:
 PIN 1. GATE
 2. SOURCE & SUBSTRATE
 3. DRAIN

STYLE 7:
 PIN 1. SOURCE
 2. DRAIN
 3. GATE

STYLE 8:
 PIN 1. DRAIN
 2. GATE
 3. SOURCE & SUBSTRATE

STYLE 9:
 PIN 1. BASE 1
 2. EMITTER
 3. BASE 2

STYLE 10:
 PIN 1. CATHODE
 2. GATE
 3. ANODE

STYLE 11:
 PIN 1. ANODE
 2. CATHODE & ANODE
 3. CATHODE

STYLE 12:
 PIN 1. MAIN TERMINAL 1
 2. GATE
 3. MAIN TERMINAL 2

STYLE 13:
 PIN 1. ANODE 1
 2. GATE
 3. CATHODE 2

STYLE 14:
 PIN 1. EMITTER
 2. COLLECTOR
 3. BASE

STYLE 15:
 PIN 1. ANODE 1
 2. CATHODE
 3. ANODE 2

STYLE 16:
 PIN 1. ANODE
 2. GATE
 3. CATHODE

STYLE 17:
 PIN 1. COLLECTOR
 2. BASE
 3. EMITTER

STYLE 18:
 PIN 1. ANODE
 2. CATHODE
 3. NOT CONNECTED

STYLE 19:
 PIN 1. GATE
 2. ANODE
 3. CATHODE

STYLE 20:
 PIN 1. NOT CONNECTED
 2. CATHODE
 3. ANODE

STYLE 21:
 PIN 1. COLLECTOR
 2. EMITTER
 3. BASE

STYLE 22:
 PIN 1. SOURCE
 2. GATE
 3. DRAIN

STYLE 23:
 PIN 1. GATE
 2. SOURCE
 3. DRAIN

STYLE 24:
 PIN 1. EMITTER
 2. COLLECTOR/ANODE
 3. CATHODE

STYLE 25:
 PIN 1. MT 1
 2. GATE
 3. MT 2

STYLE 26:
 PIN 1. V_{CC}
 2. GROUND 2
 3. OUTPUT

STYLE 27:
 PIN 1. MT
 2. SUBSTRATE
 3. MT

STYLE 28:
 PIN 1. CATHODE
 2. ANODE
 3. GATE

STYLE 29:
 PIN 1. NOT CONNECTED
 2. ANODE
 3. CATHODE

STYLE 30:
 PIN 1. DRAIN
 2. GATE
 3. SOURCE

STYLE 31:
 PIN 1. GATE
 2. DRAIN
 3. SOURCE

STYLE 32:
 PIN 1. BASE
 2. COLLECTOR
 3. EMITTER

STYLE 33:
 PIN 1. RETURN
 2. INPUT
 3. OUTPUT

STYLE 34:
 PIN 1. INPUT
 2. GROUND
 3. LOGIC

STYLE 35:
 PIN 1. GATE
 2. COLLECTOR
 3. EMITTER

DOCUMENT NUMBER:	98ASB42022B	Electronic versions are uncontrolled except when accessed directly from the Document Repository. Printed versions are uncontrolled except when stamped "CONTROLLED COPY" in red.
STATUS:	ON SEMICONDUCTOR STANDARD	
NEW STANDARD:		
DESCRIPTION:	TO-92 (TO-226)	PAGE 2 OF 3

ON Semiconductor and  are trademarks of Semiconductor Components Industries, LLC dba ON Semiconductor or its subsidiaries in the United States and/or other countries. ON Semiconductor owns the rights to a number of patents, trademarks, copyrights, trade secrets, and other intellectual property. A listing of ON Semiconductor's product/patent coverage may be accessed at www.onsemi.com/site/pdf/Patent-Marking.pdf. ON Semiconductor reserves the right to make changes without further notice to any products herein. ON Semiconductor makes no warranty, representation or guarantee regarding the suitability of its products for any particular purpose, nor does ON Semiconductor assume any liability arising out of the application or use of any product or circuit, and specifically disclaims any and all liability, including without limitation special, consequential or incidental damages. Buyer is responsible for its products and applications using ON Semiconductor products, including compliance with all laws, regulations and safety requirements or standards, regardless of any support or applications information provided by ON Semiconductor. "Typical" parameters which may be provided in ON Semiconductor data sheets and/or specifications can and do vary in different applications and actual performance may vary over time. All operating parameters, including "Typicals" must be validated for each customer application by customer's technical experts. ON Semiconductor does not convey any license under its patent rights nor the rights of others. ON Semiconductor products are not designed, intended, or authorized for use as a critical component in life support systems or any FDA Class 3 medical devices or medical devices with a same or similar classification in a foreign jurisdiction or any devices intended for implantation in the human body. Should Buyer purchase or use ON Semiconductor products for any such unintended or unauthorized application, Buyer shall indemnify and hold ON Semiconductor and its officers, employees, subsidiaries, affiliates, and distributors harmless against all claims, costs, damages, and expenses, and reasonable attorney fees arising out of, directly or indirectly, any claim of personal injury or death associated with such unintended or unauthorized use, even if such claim alleges that ON Semiconductor was negligent regarding the design or manufacture of the part. ON Semiconductor is an Equal Opportunity/Affirmative Action Employer. This literature is subject to all applicable copyright laws and is not for resale in any manner.

PUBLICATION ORDERING INFORMATION

LITERATURE FULFILLMENT:

Email Requests to: orderlit@onsemi.com

ON Semiconductor Website: www.onsemi.com

TECHNICAL SUPPORT

North American Technical Support:
Voice Mail: 1 800-282-9855 Toll Free USA/Canada
Phone: 011 421 33 790 2910

Europe, Middle East and Africa Technical Support:

Phone: 00421 33 790 2910

For additional information, please contact your local Sales Representative

