

“ZNR” Transient/Surge Absorbers

Type : **E**

The ZNR Type E is capable of handling larger surge energy than Type D in applications to protect electronic equipment or semiconductor devices from switching and induced lightning surges.



Features

- UL and CSA recognized components
- Very large surge withstanding capability with a compact size
- Direct mounting on boards like a power distribution board available
- Fast response to steep impulse voltage
- Low clamping voltage for better surge protection
- RoHS compliant

Recommended Applications

- Transistor, diode, IC, thyristor or triac semiconductor protection
- Surge protection in industrial power plant operations
- Relay or electromagnetic valve surge absorption
- Surge absorption applications in broadcasting, communications devices, traffic/railroad, agricultural facilities, waterworks
- Surge protection of automatic control devices for power distribution line

Related Standards

Standard No.	UL1449	CSA C22.2 No.1 Class 2221 01
Title	Surge Protective Devices	Accessories and Parts for Electronic Products (Varistor for Across-The-Line use as transient protection on 120V ac nominal system)

- Each type designation is not registered by Part Number.

Note : Ask our factory for Product Specification before use.

As for Handling Precautions and Minimum Quantity / Packing Unit

Please see Related Information

Explanation of Part Numbers

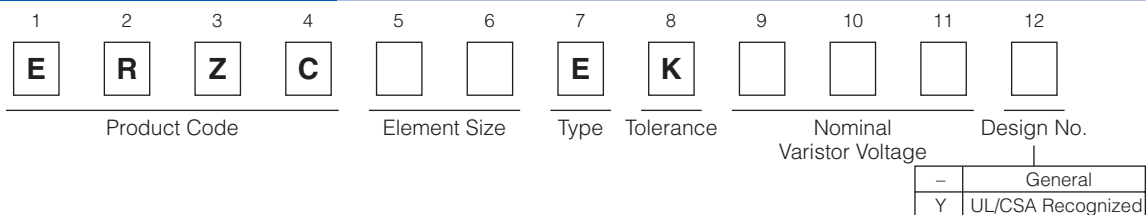

Dimensions in mm (not to scale)

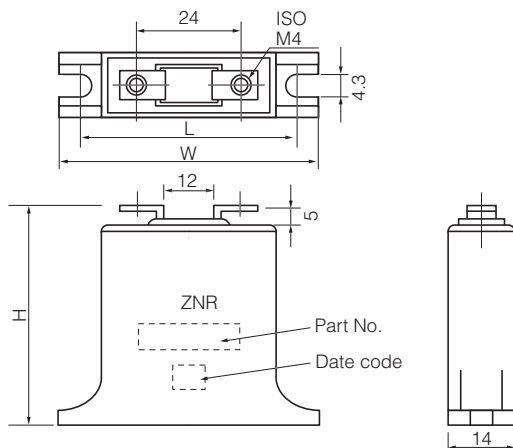

Part No.	W	H	L
ERZC20EK□□□(Y)	48±1	42±1	39±1
ERZC32EK□□□(Y)	60±1	55±1	51±1

(Unit : mm)

20 Series (UL and CSA Recognized)

Ratings and Characteristics(ERZC20EK)

- Operating Temperature Range : -40 to 85 °C
- Storage Temperature Range : -40 to 110 °C

Part No. (UL/CSA Recognized)	Type Designation	Varistor Voltage V_{1mA} (V)	Maximum Allowable Voltage		Maximum Clamping Voltage V_{100A} (V)	Energy (2 ms)	Maximum Peak Current (8/20 μ s)	Rated Voltage (UL/CSA) ACrms (V)
			ACrms (V)	DC (V)		1 time (J)	1 time (A)	
ERZC20EK201Y	20EK201U	200 (185 to 225)	130	170	340	80	8000	118
ERZC20EK241Y	20EK241U	240 (216 to 264)	150	200	395	95	8000	136
ERZC20EK271Y	20EK271U	270 (247 to 303)	175	225	455	100	8000	159
ERZC20EK361Y	20EK361U	360 (324 to 396)	230	300	595	120	8000	209
ERZC20EK391Y	20EK391U	390 (351 to 429)	250	320	650	130	8000	227
ERZC20EK431Y	20EK431U	430 (387 to 473)	275	350	710	140	8000	250
ERZC20EK471Y	20EK471U	470 (423 to 517)	300	385	775	150	8000	272
ERZC20EK511Y	20EK511U	510 (459 to 561)	320	415	845	150	8000	291
ERZC20EK621Y	20EK621U	620 (558 to 682)	385	505	1025	160	8000	350
ERZC20EK681Y	20EK681U	680 (612 to 748)	420	560	1120	175	8000	381
ERZC20EK751Y	20EK751U	750 (675 to 825)	460	615	1240	190	8000	418
ERZC20EK781Y	20EK781U	780 (702 to 858)	485	640	1290	200	8000	440
ERZC20EK821Y	20EK821U	820 (738 to 902)	510	670	1355	215	8000	463
ERZC20EK911Y	20EK911U	910 (819 to 1001)	550	745	1500	240	8000	500
ERZC20EK102Y	20EK102U	1000 (900 to 1100)	625	825	1650	245	8000	568
ERZC20EK112Y	20EK112U	1100 (990 to 1210)	680	895	1815	250	8000	600

32 Series (UL and CSA Recognized)

Ratings and Characteristics(ERZC32EK)

- Operating Temperature Range : -40 to 85 °C
- Storage Temperature Range : -40 to 110 °C

Part No. (UL/CSA Recognized)	Type Designation	Varistor Voltage V_{1mA} (V)	Maximum Allowable Voltage		Maximum Clamping Voltage V_{100A} (V)	Energy (2 ms)	Maximum Peak Current (8/20 μ s)	Rated Voltage (UL/CSA) ACrms (V)
			ACrms (V)	DC (V)		1 time (J)	1 time (A)	
ERZC32EK201Y	32EK201U	200 (185 to 225)	130	170	340	210	25000	118
ERZC32EK241Y	32EK241U	240 (216 to 264)	150	200	395	240	25000	136
ERZC32EK271Y	32EK271U	270 (247 to 303)	175	225	455	255	25000	159
ERZC32EK361Y	32EK361U	360 (324 to 396)	230	300	595	325	25000	209
ERZC32EK391Y	32EK391U	390 (351 to 429)	250	320	650	350	25000	227
ERZC32EK431Y	32EK431U	430 (387 to 473)	275	350	710	400	25000	250
ERZC32EK471Y	32EK471U	470 (423 to 517)	300	385	775	405	25000	272
ERZC32EK511Y	32EK511U	510 (459 to 561)	320	415	845	405	25000	291
ERZC32EK621Y	32EK621U	620 (558 to 682)	385	505	1025	415	25000	350
ERZC32EK681Y	32EK681U	680 (612 to 748)	420	560	1120	450	25000	381
ERZC32EK751Y	32EK751U	750 (675 to 825)	460	615	1240	500	25000	418
ERZC32EK781Y	32EK781U	780 (702 to 858)	485	640	1290	520	25000	440
ERZC32EK821Y	32EK821U	820 (738 to 902)	510	670	1355	545	25000	463
ERZC32EK911Y	32EK911U	910 (819 to 1001)	550	745	1500	600	25000	500
ERZC32EK102Y	32EK102U	1000 (900 to 1100)	625	825	1650	620	25000	568
ERZC32EK112Y	32EK112U	1100 (990 to 1210)	680	895	1815	640	25000	600

20 Series

Ratings and Characteristics(ERZC20EK)

- Operating Temperature Range : -40 to 85 °C
- Storage Temperature Range : -40 to 110 °C

Part No.	Varistor Voltage	Maximum Allowable Voltage		Maximum Clamping Voltage	Rated Power	Energy (2 ms)	Maximum Peak Current (8/20 μs)		Typical Capacitance (Reference) at 1kHz (pF)
		ACrms (V)	DC (V)				1 time	2 times	
	V _{1mA} (V)	ACrms (V)	DC (V)	V _{100A} (V)	(W)	(J)	(A)	(A)	
ERZC20EK201	200 (185 to 225)	130	170	340	0.8	80	8000	5000	2300
ERZC20EK241	240 (216 to 264)	150	200	395	0.8	95	8000	5000	1500
ERZC20EK271	270 (247 to 303)	175	225	455	0.8	100	8000	5000	1400
ERZC20EK361	360 (324 to 396)	230	300	595	0.8	120	8000	5000	1300
ERZC20EK391	390 (351 to 429)	250	320	650	0.8	130	8000	5000	1200
ERZC20EK431	430 (387 to 473)	275	350	710	0.8	140	8000	5000	1000
ERZC20EK471	470 (423 to 517)	300	385	775	0.8	150	8000	5000	950
ERZC20EK511	510 (459 to 561)	320	415	845	0.8	150	8000	5000	930
ERZC20EK621	620 (558 to 682)	385	505	1025	0.8	160	8000	5000	900
ERZC20EK681	680 (612 to 748)	420	560	1120	0.8	175	8000	5000	850
ERZC20EK751	750 (675 to 825)	460	615	1240	0.8	190	8000	5000	800
ERZC20EK781	780 (702 to 858)	485	640	1290	0.8	200	8000	5000	800
ERZC20EK821	820 (738 to 902)	510	670	1355	0.8	215	8000	5000	700
ERZC20EK911	910 (819 to 1001)	550	745	1500	0.8	240	8000	5000	700
ERZC20EK102	1000 (900 to 1100)	625	825	1650	0.8	245	8000	5000	400
ERZC20EK112	1100 (990 to 1210)	680	895	1815	0.8	250	8000	5000	350

32 Series

Ratings and Characteristics(ERZC32EK)

- Operating Temperature Range : -40 to 85 °C
- Storage Temperature Range : -40 to 110 °C

Part No.	Varistor Voltage	Maximum Allowable Voltage		Maximum Clamping Voltage	Rated Power	Energy (2 ms)	Maximum Peak Current (8/20 μs)		Typical Capacitance (Reference) at 1kHz (pF)
		ACrms (V)	DC (V)				1 time	2 times	
	V _{1mA} (V)	ACrms (V)	DC (V)	V _{200A} (V)	(W)	(J)	(A)	(A)	
ERZC32EK201	200 (185 to 225)	130	170	340	1.2	210	25000	20000	5500
ERZC32EK241	240 (216 to 264)	150	200	395	1.2	240	25000	20000	5000
ERZC32EK271	270 (247 to 303)	175	225	455	1.2	255	25000	20000	4200
ERZC32EK361	360 (324 to 396)	230	300	595	1.2	325	25000	20000	3500
ERZC32EK391	390 (351 to 429)	250	320	650	1.2	350	25000	20000	3000
ERZC32EK431	430 (387 to 473)	275	350	710	1.2	400	25000	20000	2500
ERZC32EK471	470 (423 to 517)	300	385	775	1.2	405	25000	20000	2500
ERZC32EK511	510 (459 to 561)	320	415	845	1.2	405	25000	20000	2400
ERZC32EK621	620 (558 to 682)	385	505	1025	1.2	415	25000	20000	2200
ERZC32EK681	680 (612 to 748)	420	560	1120	1.2	450	25000	20000	2100
ERZC32EK751	750 (675 to 825)	460	615	1240	1.2	500	25000	20000	2000
ERZC32EK781	780 (702 to 858)	485	640	1290	1.2	520	25000	20000	1900
ERZC32EK821	820 (738 to 902)	510	670	1355	1.2	545	25000	20000	1800
ERZC32EK911	910 (819 to 1001)	550	745	1500	1.2	600	25000	20000	1700
ERZC32EK102	1000 (900 to 1100)	625	825	1650	1.2	620	25000	20000	1000
ERZC32EK112	1100 (990 to 1210)	680	895	1815	1.2	640	25000	20000	800

Design and specifications are each subject to change without notice. Ask factory for the current technical specifications before purchase and/or use.
Should a safety concern arise regarding this product, please be sure to contact us immediately.

Typical Characteristics (Type E)

Voltage vs. Current

(ERZC20EK201(Y) to ERZC20EK511(Y))

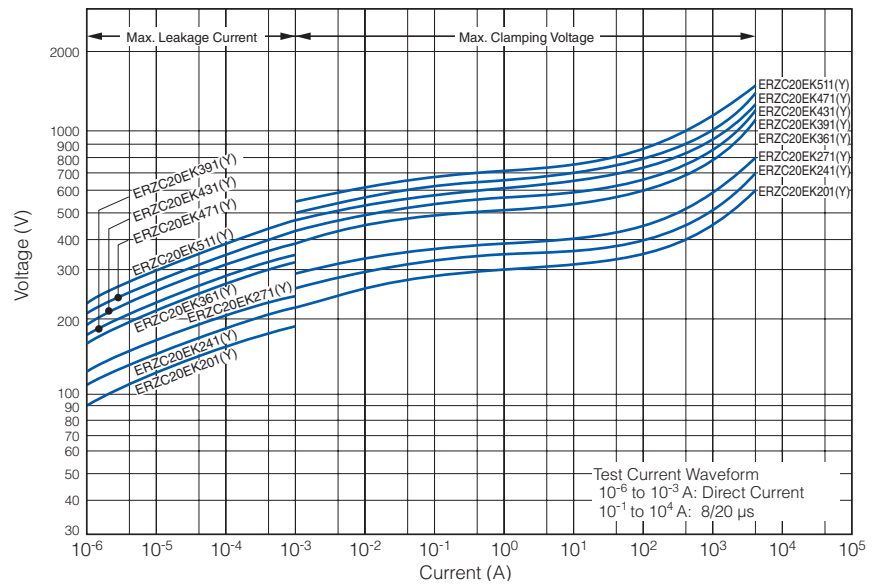

(ERZC20EK621(Y) to ERZC20EK112(Y))

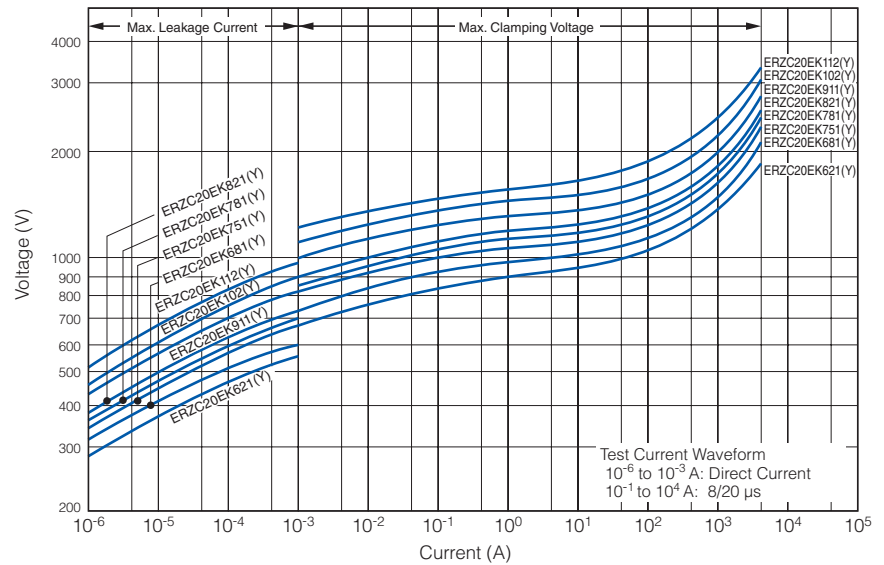

Impulse Derating Curve (Relation between impulse width and surge, repetitively)

20 Series
(ERZC20EK201(Y) to ERZC20EK271(Y))

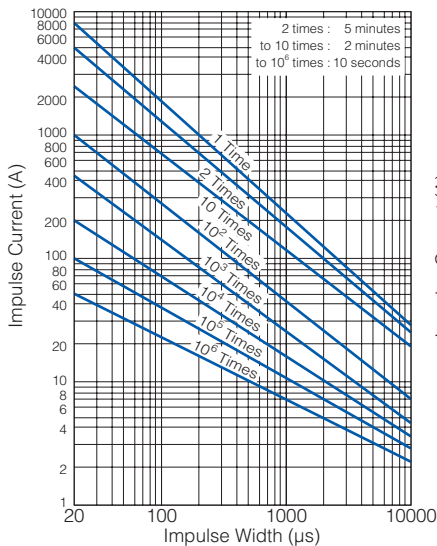

20 Series
(ERZC20EK361(Y) to ERZC20EK681(Y))

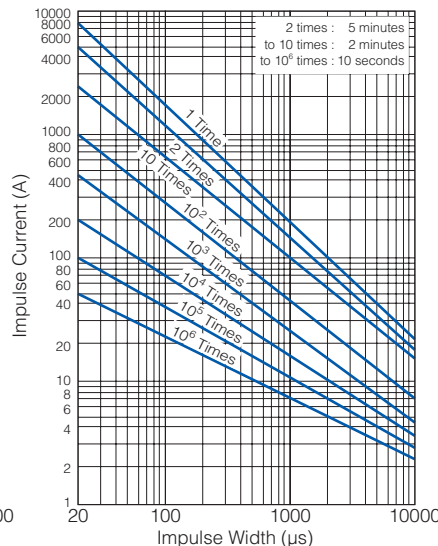

20 Series
(ERZC20EK751(Y) to ERZC20EK112(Y))

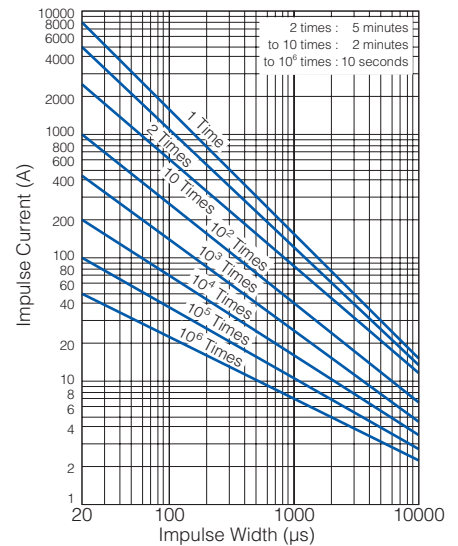

Typical Characteristics (Type E)

Voltage vs. Current

(ERZC32EK201(Y) to ERZC32EK511(Y))

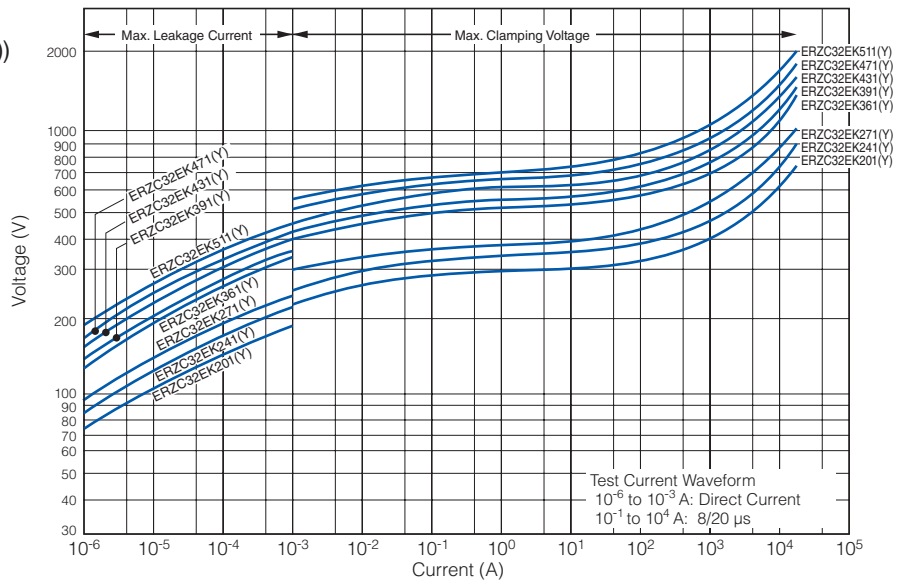

(ERZC32EK621(Y) to ERZC32EK112(Y))

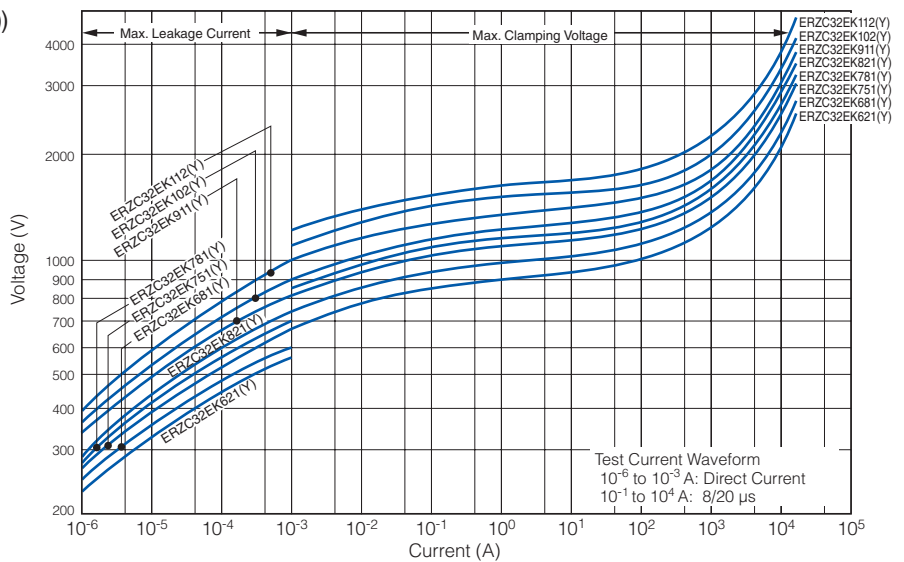

Impulse Derating Curve (Relation between impulse width and surge, repetitively)

32 Series
(ERZC32EK201(Y) to ERZC32EK271(Y))

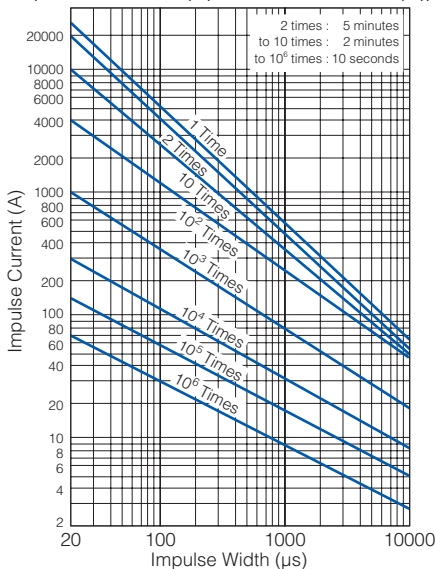

32 Series
(ERZC32EK361(Y) to ERZC32EK681(Y))

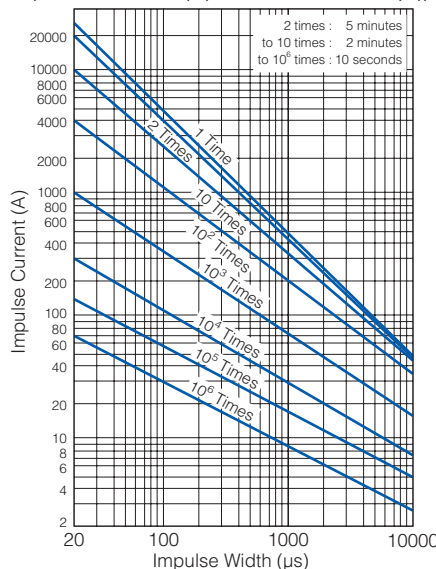

32 Series
(ERZC32EK751(Y) to ERZC32EK112(Y))

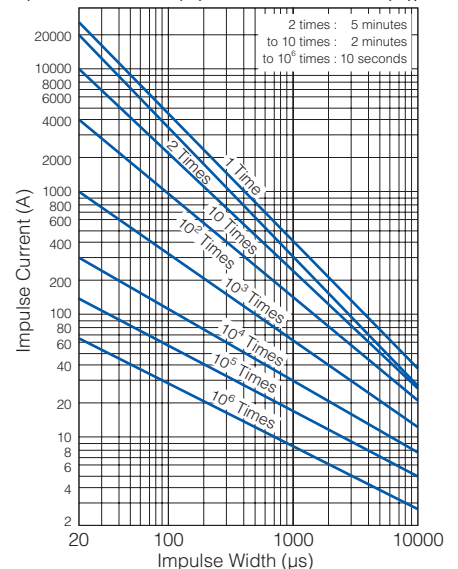

Performance Characteristics (Type E)

Characteristics		Test Methods/Description	Specifications															
Standard Test Condition		Electrical characteristics shall be measured at following conditions (Temperature: 5 to 35 °C, Humidity: Max. 85 %)	—															
Varistor Voltage		The voltage between two terminals with the specified measuring current C_{mA} DC applied is called V_c or V_{CmA} . The measurement shall be made as fast as possible to avoid heat affection.	To meet the specified value.															
Maximum Allowable Voltage		The maximum sinusoidal wave voltage (rms) or the maximum DC voltage that can be applied continuously.																
Clamping Voltage		The maximum voltage between two terminals with the specified standard impulse current (8/20 μ s).																
Rated Power		The maximum power that can be applied within the specified ambient temperature.																
Energy		The maximum energy within the varistor voltage change of ± 10 % when one impulse of 2 ms is applied.																
Maximum Peak Current	2 times	The maximum current within the varistor voltage change of ± 10 % with the standard impulse current (8/20 μ s) applied two times with an interval of 5 minutes.																
	1 time	The maximum current within the varistor voltage change of ± 10 % with the standard impulse current (8/20 μ s) applied one time.																
Temperature Coefficient of Varistor Voltage		$\frac{V_c \text{ at } 70\text{ }^\circ\text{C} - V_c \text{ at } 20\text{ }^\circ\text{C}}{V_c \text{ at } 20\text{ }^\circ\text{C}} \times \frac{1}{50} \times 100 \text{ (\%/}^\circ\text{C)}$		0 to -0.05 %/ $^\circ$ C max.														
Impulse Life		The change of V_c shall be measured after the impulse listed below is applied 10000 times continuously with the interval of ten seconds at room temperature. <table border="1" style="margin-left: auto; margin-right: auto;"> <tr> <td>20 Series</td> <td>200 A (8/20 μs)</td> </tr> <tr> <td>32 Series</td> <td>300 A (8/20 μs)</td> </tr> </table>		20 Series	200 A (8/20 μ s)	32 Series	300 A (8/20 μ s)	$\Delta V_{1\text{ mA}}/V_{1\text{ mA}} \leq \pm 10$ %										
20 Series	200 A (8/20 μ s)																	
32 Series	300 A (8/20 μ s)																	
Withstanding Voltage (Body Insulation)		The commercial frequency voltage of AC 2.5 kV shall be applied between terminals and the bottom of the unit for one minute.	No remarkable damage															
Mechanical	Robustness of Terminations (Tensile)	After gradually applying the load of 49 N (5 kgf) and keeping the unit fixed for 10 seconds in an axial direction, the terminal shall be visually examined for any damage.	No remarkable damage															
	Vibration	After repeatedly applying a single harmonic vibration (amplitude: 0.75 mm): double amplitude: 1.5 mm with 1 minute vibration frequency cycles (10 Hz to 55 Hz to 10 Hz) to each of three perpendicular directions for 2 hours. Thereafter, the damage of the terminals is visually examined.																
Environmental	Dry Heat/ High Temperature Storage	The specimen shall be subjected to 110 ± 3 °C for 500 hours in a thermostatic bath without load and then stored at room temperature and humidity for one to two hours. Thereafter, the change of V_c shall be measured. <table border="1" style="margin-left: auto; margin-right: auto;"> <thead> <tr> <th>Step</th> <th>Temperature (°C)</th> <th>Period (minutes)</th> </tr> </thead> <tbody> <tr> <td>1</td> <td>-25_{-3}^0</td> <td>30_{-3}^0</td> </tr> <tr> <td>2</td> <td>Room Temp.</td> <td>3 max.</td> </tr> <tr> <td>3</td> <td>85_{-3}^0</td> <td>30_{-3}^0</td> </tr> <tr> <td>4</td> <td>Room Temp.</td> <td>3 max.</td> </tr> </tbody> </table>	Step	Temperature (°C)	Period (minutes)	1	-25_{-3}^0	30_{-3}^0	2	Room Temp.	3 max.	3	85_{-3}^0	30_{-3}^0	4	Room Temp.	3 max.	$\Delta V_{1\text{ mA}}/V_{1\text{ mA}} \leq \pm 5$ %
	Step	Temperature (°C)	Period (minutes)															
	1	-25_{-3}^0	30_{-3}^0															
	2	Room Temp.	3 max.															
	3	85_{-3}^0	30_{-3}^0															
4	Room Temp.	3 max.																
Temperature Cycle		The temperature cycle shown below shall be repeated five times and then stored at room temperature and humidity for one to two hours. The change of V_c and mechanical damage shall be examined.	No remarkable damage $\Delta V_{1\text{ mA}}/V_{1\text{ mA}} \leq \pm 5$ %															
Dry Heat Load/ High Temperature Load		After being continuously applied the Maximum Allowable Voltage at 85 ± 5 °C for 500 hours, the specimen shall be stored at room temperature and humidity for one to two hours. Thereafter, the change of V_c shall be measured.	$\Delta V_{1\text{ mA}}/V_{1\text{ mA}} \leq \pm 10$ %															
Damp Heat/Humidity (Steady State)		The specimen shall be subjected to 40 ± 2 °C, 90 to 95 %RH for 1000 hours without load and then stored at room temperature and humidity for one to two hours. Thereafter, the change of V_c shall be measured.	$\Delta V_{1\text{ mA}}/V_{1\text{ mA}} \leq \pm 5$ %															

Mouser Electronics

Authorized Distributor

Click to View Pricing, Inventory, Delivery & Lifecycle Information:

Panasonic:

[ERZ-C20EK241](#) [ERZ-C32EK201](#) [ERZ-C32EK911](#) [ERZ-C32EK751](#) [ERZ-C20EK201](#) [ERZ-C20EK391](#) [ERZ-C25EK391](#) [ERZ-C25EK781](#) [ERZ-C25EK821](#) [ERZ-C32EK241](#) [ERZ-C32EK391](#) [ERZ-C20EK431](#) [ERZ-C20EK471](#) [ERZ-C20EK361](#) [ERZ-C20EK201Y](#) [ERZ-C32EK102Y](#) [ERZ-C20EK911Y](#) [ERZ-C32EK361Y](#) [ERZ-C32EK271Y](#) [ERZ-C20EK511Y](#) [ERZ-C20EK781Y](#) [ERZ-C32EK821Y](#) [ERZ-C20EK391Y](#) [ERZ-C32EK112Y](#) [ERZ-C20EK751Y](#) [ERZ-C32EK621Y](#) [ERZ-C32EK911Y](#) [ERZ-C32EK241Y](#) [ERZ-C20EK471Y](#) [ERZ-C20EK821Y](#) [ERZ-C32EK201Y](#) [ERZ-C20EK361Y](#) [ERZ-C20EK271Y](#) [ERZ-C20EK112Y](#) [ERZ-C32EK781Y](#) [ERZ-C20EK241Y](#) [ERZ-C20EK431Y](#) [ERZ-C32EK391Y](#) [ERZ-C32EK471Y](#) [ERZ-C20EK102Y](#) [ERZ-C32EK511Y](#) [ERZ-C20EK681Y](#) [ERZ-C32EK751Y](#) [ERZ-C32EK431Y](#) [ERZ-C20EK621Y](#) [ERZ-C32EK681Y](#) [ERZ-C20EK221Y](#) [ERZ-C32EK221Y](#)