

Panel Mounting Touchproof, Sealed to IP68, PC2

PANEL MOUNT



FX0419

- Panel Sealed to IP68
- Touchproof Category PC2
- Fuse Size 6.3 x 32mm
- Screw Cap/Screwdriver/Hand Release
- 16A, 250V ac

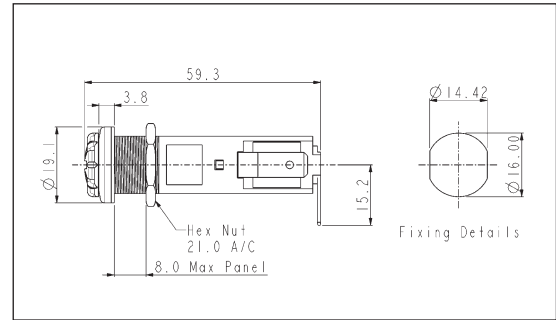

PANEL MOUNT



FX0462

- Panel Sealed to IP68
- Touchproof Category PC2
- Fuse Size 5 x 20mm
- Screw Cap/Screwdriver/Hand Release
- 10A, 250V ac

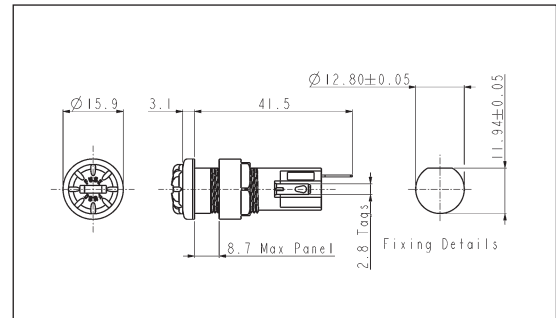

PANEL MOUNT



FX0463

- Panel Sealed to IP68
- Touchproof Category PC2
- Fuse Size 5 x 20mm
- High Profile Bezel
- Screw Cap/Screwdriver/Hand Release
- 10A, 250V ac

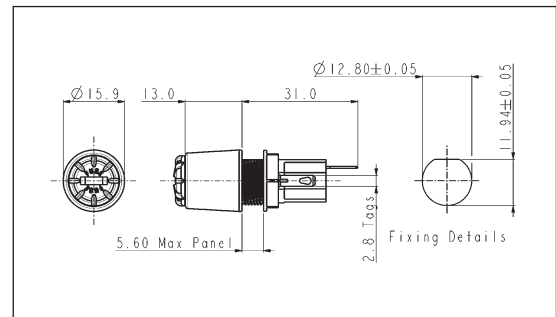

Specification	FX0419	FX0462	FX0463
Fuse Size:	6.3 x 32mm	5 x 20mm	5 x 20mm
Fuse Carrier:	Screw cap/Screwdriver/Hand release	Screw cap/Screwdriver/Hand release	Screw cap/Screwdriver/Hand release
Terminations:	6.3 series tabs	Solder tags	Solder tags
Max. Rating:	16A, 250V ac	10A, 250V ac	10A, 250V ac
Max. Power Dissipation:	2.5W (@ 23°C)	2.5W (@ 23°C)	2.5W (@ 23°C)
Insulation Resistance:	>10 ⁶ MΩ @ 500V d.c.	>10 ² MΩ @ 500V d.c.	>10 ² MΩ @ 500V d.c.
A.C. Breakdown:	>2kV @ 50Hz	7kV @ 50Hz	7kV @ 50Hz
Contact Resistance:	<10mΩ	<10mΩ	<10mΩ
Operating Temp:	-20°C to +85°C (ambient air temp + fuse temp rise)	-20°C to +85°C (ambient air temp + fuse temp rise)	-20°C to +85°C (ambient air temp + fuse temp rise)
Mouldings:			
Body:	Polyester UL94V-0 rated	Polyester UL94V-0 rated	Polyester UL94V-0 rated
Cap:	Nylon UL94V-0 rated	Nylon UL94V-0 rated	Nylon UL94V-0 rated
Nut:	Glass Filled Nylon UL94V-0 rated	Glass Filled Nylon UL94V-0 rated	Glass Filled Nylon UL94V-0 rated
Contacts:	Brass, Silver Plated	Brass, Silver Plated	Brass, Silver Plated
Tightening Torque:			
Cap:	0.5-0.6Nm (4.43-5.3lbf.in.)	0.4-0.6Nm (3.54-5.3lbf.in.)	0.4-0.6Nm (3.54-5.3lbf.in.)
Panel Nut:	0.5Nm (4.4lbf.in.)	0.5Nm (4.4lbf.in.)	0.5Nm (4.4lbf.in.)
Sealing:	IP68 to EN60529:1992	IP68 to EN60529:1992	IP68 to EN60529:1992
Approvals:			
Accessories:	-	P.Nos. 11327 (See page 163)	P.No. 11327(See page 163)
RoHS	Compliant	Compliant	Compliant