

## Current-compensated Chokes



- Rated currents from 6 to 64 A
- Up to 600 VAC or 850 VDC
- DC to 400 Hz frequencies
- Dual, triple and quad-choke configurations



### Approvals & Compliances

## RoHS

RD chokes are attenuating common-mode or asymmetric (P/N → E) interference signals, by being connected in series with the phase and neutral lines of an AC powerline input. Symmetrical components of the noise are also attenuated by the leakage inductance of the windings. These chokes are typically used in conjunction with suppression capacitors.

### Features and Benefits

- High saturation resistance and excellent thermal behavior
- Through hole or wire connections
- Dual, triple and quad-choke configuration
- Up to 64 A quad configuration
- Multiple housing options
- Custom-specific versions are available on request

### Typical Applications

- Phase-angle control circuits in combination with saturating chokes
- EMI input filters
- For suppressing equipment with no earth connection
- Suppressing high interference levels







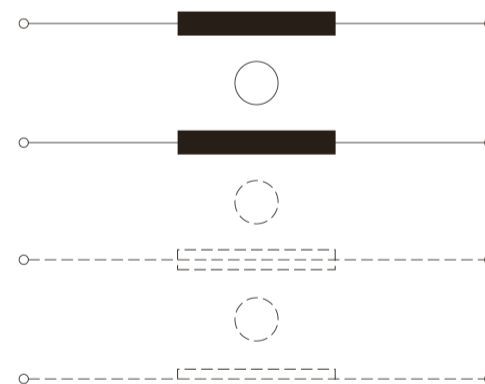



































### Technical Specifications

Maximum continuous operating voltage	600 VAC/850 VDC @ 40°C
Operating frequency	DC to 400 Hz
Rated currents	6 to 64 A @ 40°C max.
High potential test voltage winding-to-winding	2500 V, 50 Hz, 2 sec, factory test 2500 VAC, 60 sec, guaranteed
winding-to-housing	4000 VAC, 60 sec, guaranteed
Surge current @ 10 msec	20 × I <sub>N</sub> @ 25 °C
Temperature range (operation and storage)	-25°C to +110°C (25/110/21)
Flammability corresponding to MTBF @ 40°C/230 V (Mil-HB-217F)	UL 94 V-0 (insulation tubes UL 94 V-2) >5,000,000 hours

### Typical electrical schematic



## Choke Selection Table

Choke	Buy	Nominal current @ 40°C [A]	Inductance L [mH/path]	Resistance R [mΩ/path]	Choke configuration [Qty]	Input/Output connections	Pin footprint connections [mm]	Weight [g]
RD5122-6-9m6		6	9.6	52.55	2	-02	Ø1	160
RD5122-10-6m0		10	6	24.25	2	-02	Ø1.3	160
RD5122-16-2m0		16	2	9.5	2	-02	Ø1.6	160
RD5132-6-5m0		6	5	38	3	-02	Ø1	160
RD5132-10-3m0		10	3	17.6	3	-02	Ø1.3	160
RD5132-16-1m0		16	1	6.9	3	-02	Ø1.6	160
RD6127-6-15m0		6	15	66.65	2	-07	Ø1	235
RD6127-10-9m0		10	9	25.9	2	-07	Ø1.5	235
RD6127-16-3m0		16	3	10.9	2	-07	Ø1.8	235
RD6137-6-7m5		6	7.5	49	3	-07	Ø1	235
RD6137-10-4m5		10	4.5	18.35	3	-07	Ø1.5	235
RD6137-16-1m5		16	1.5	8.3	3	-07	Ø1.8	235
RD7127-6-25m0		6	25	84.2	2	-07	Ø1	320
RD7127-10-14m0		10	14	33.5	2	-07	Ø1.4	350
RD7127-16-5m7		16	5.7	14.1	2	-07	Ø1.8	370
RD7127-25-2m8		25	2.8	6.4	2	-07	Ø2.4	400
RD7127-36-1m0		36	1	3.3	2	-07	Ø2.7	380
RD7137-6-12m0		6	12	60.6	3	-07	Ø1	340
RD7137-10-6m6		10	6.6	21.9	3	-07	Ø1.5	380
RD7137-16-2m8		16	2.8	10.7	3	-07	Ø1.8	380
RD7137-25-1m3		25	1.3	4.45	3	-07	Ø2.5	440
RD7137-36-0m5		36	0.5	2.75	3	-07	Ø2.7	400
RD7147-6-6m0		6	6	45.1	4	-07	Ø1	320
RD7147-10-3m5		10	3.5	19.1	4	-07	Ø1.4	370
RD7147-16-1m5		16	1.5	8.5	4	-07	Ø1.8	390
RD7147-25-0m7		25	0.7	3.65	4	-07	Ø2.4	430
RD7147-36-0m2		36	0.2	2.3	4	-07	Ø2.5	400
RD8127-16-12m0		16	12	20.05	2	-07	Ø2	590
RD8127-25-5m0		25	5	8.45	2	-07	Ø2.4	630
RD8127-36-3m0		36	3	4.55	2	-07	1.5 x 4.5	690
RD8127-50-1m0		50	1	2.5	2	-07	1.7 x 5	640
RD8127-64-0m8		64	0.8	1.6	2	-07	2.5 x 5	710
RD8137-16-5m0		16	5	11.6	3	-07	Ø2	630
RD8137-25-2m5		25	2.5	6.4	3	-07	Ø2.4	650
RD8137-36-1m5		36	1.5	3.65	3	-07	1.5 x 4.5	720
RD8137-50-0m6		50	0.6	2.15	3	-07	1.7 x 5	700
RD8137-64-0m5		64	0.5	1.35	3	-07	2.5 x 5	780
RD8147-16-3m0		16	3	9.25	4	-07	Ø2	650
RD8147-25-1m3		25	1.3	5.05	4	-07	Ø2.4	650
RD8147-36-0m8		36	0.8	3	4	-07	1.5 x 4.5	760
RD8147-50-0m3		50	0.3	1.75	4	-07	1.7 x 5	740
RD8147-64-0m2		64	0.2	1.1	4	-07	2.5 x 5	820

Test conditions:

Measuring frequency: 1 kHz; 500 µA &gt;0.16 mH &gt;1.6 mH; 50 µA &gt;1.6 mH &lt;160 mH

Inductance tolerance: +50%, -30%

Resistance tolerance: ±15% @ 25 °C

Electrical characteristics @ 25°C: ±2°C

### Distribution Inventory

Up-to-date inventory levels for global distributors is available at

<https://products.schaffner.com/stock>



### Typical Choke Attenuation/Resonance Frequency Characteristics

Per CISPR 17; 50 Ω/50 Ω asym

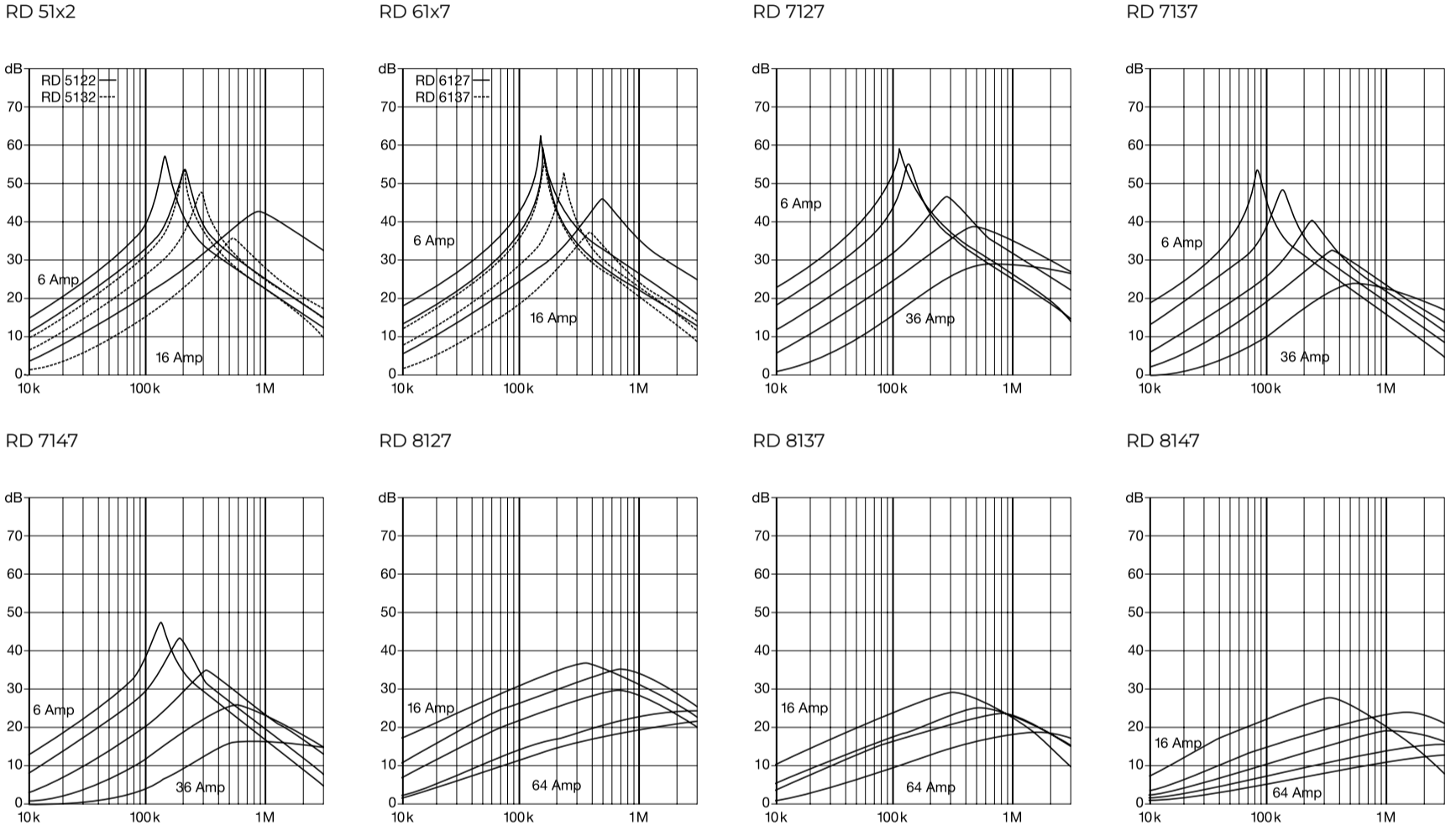

### Typical Saturation Characteristics

Inductance (typical value in %) vs. nominal current (A DC)

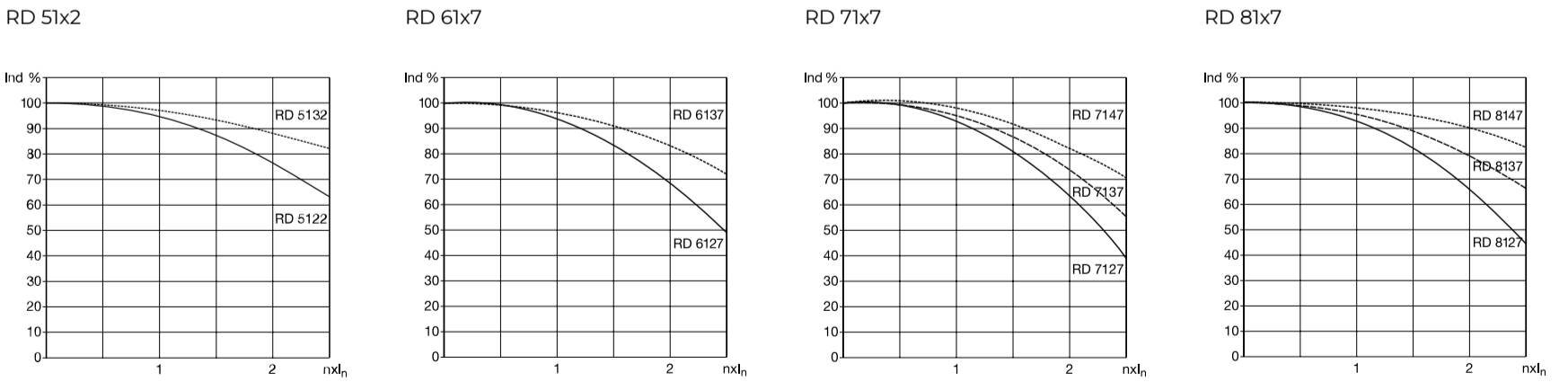

**Mechanical Data**

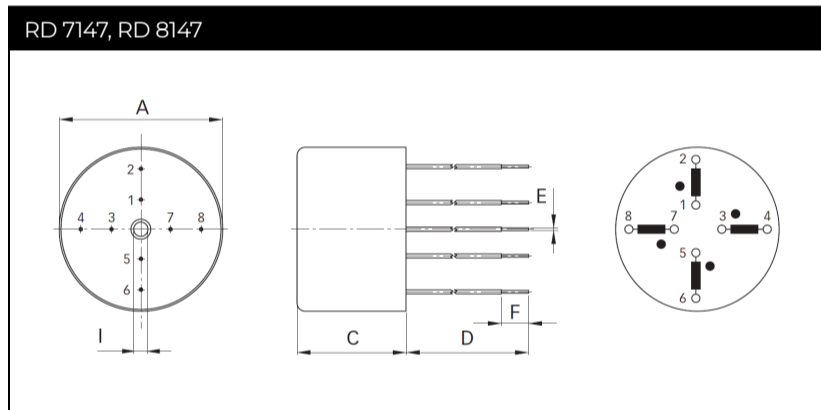
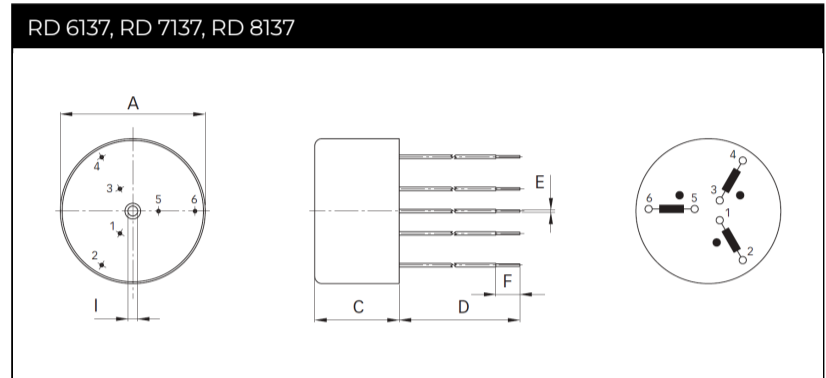
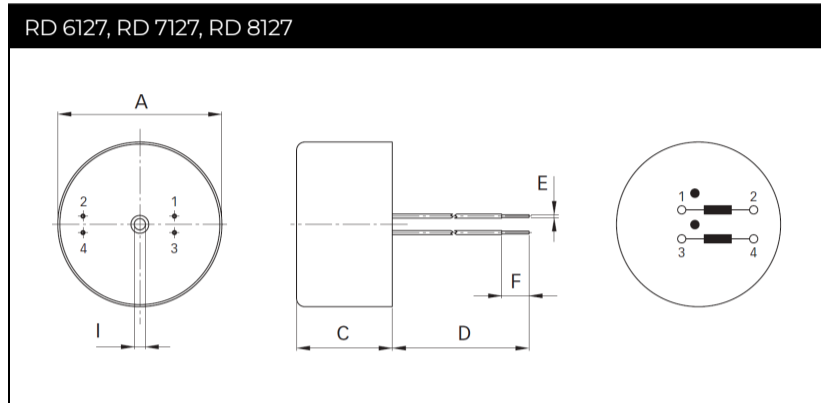
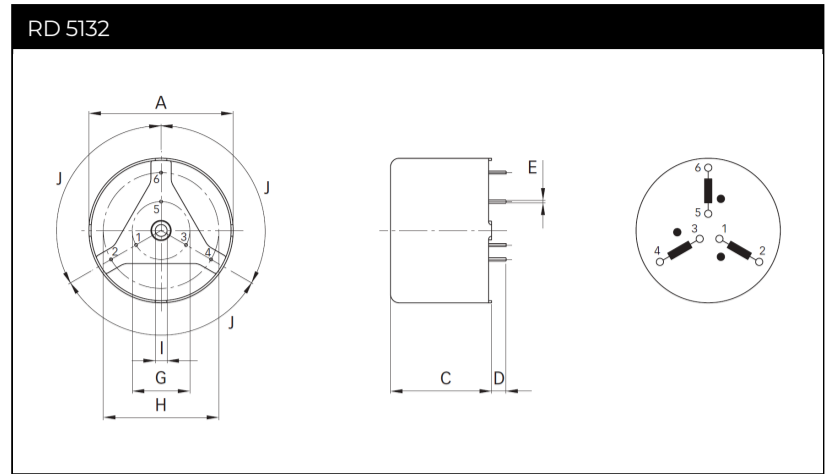
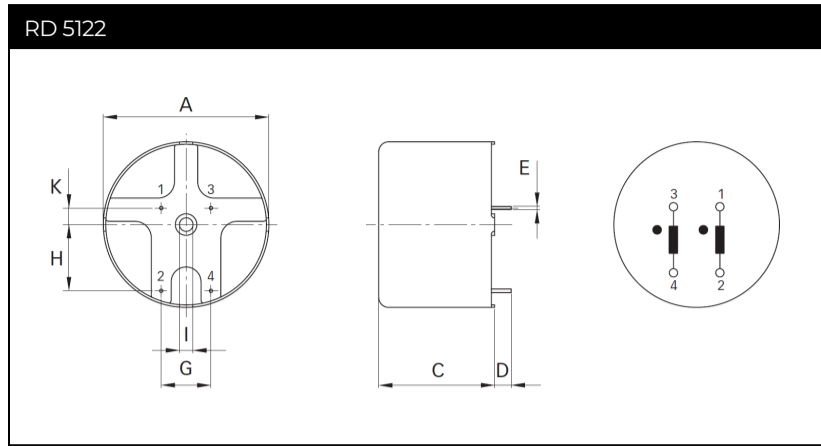

**Dimensions**

	<b>RD 5122</b>	<b>RD 5132</b>	<b>RD 6127</b>	<b>RD 6137</b>	<b>RD 7127</b>	<b>RD 7137</b>	<b>RD 7147</b>	<b>RD 8127</b>	<b>RD 8137</b>	<b>RD 8147</b>	<b>Tolerances</b>
<b>A</b>	50	50	60	60	70	70	70	80	80	80	±0.5
<b>C</b>	35	35	35	35	40	40	40	50	50	50	±0.5
<b>D</b>	5 ±0.5	5 ±0.5	150	150	150	150	150	200	200	200	+5/-0
<b>E</b>	see choke selection table										
<b>F</b>			10	10	10	10	10	20	20	20	±1
<b>G</b>	15	20									±0.3
<b>H</b>	20	40 ±0.4									±0.3
<b>I</b>	4.1 +3/-0	4.1 +3/-0	4.1 +3/-0	4.1 +3/-0	6.1	6.1	6.1	6.1	6.1	6.1	+6/-0
<b>J</b>		120°									
<b>K</b>	5										

All dimensions in mm; 1 inch = 25.4 mm  
 Tolerances according: ISO 2768-m/EN 22768-m

Please visit [www.schaffner.com](http://www.schaffner.com) to find more details on filter connectors.

## Headquarters, Global Innovation and Development

### Switzerland

#### Schaffner Holding AG

Industrie Nord  
Nordstrasse 11e  
4542  
Luterbach  
+41 32 681 66 26  
[info@schaffner.com](mailto:info@schaffner.com)

## Sales and Application Centers

### China

#### Schaffner EMC Ltd. Shanghai

T20-3 C, No 565 Chuangye Road, Pudong district  
201201  
Shanghai  
+86 2138139500  
[cschina@schaffner.com](mailto:cschina@schaffner.com)

### Finland

#### Schaffner Oy

Sauvonrinne 19 H  
8500  
Lohja  
+358 50 468 7284  
[finlandsales@schaffner.com](mailto:finlandsales@schaffner.com)

### France

#### Schaffner EMC S.A.S.

16-20 Rue Louis Rameau  
95875  
Bezons  
+33 1 34 34 30 60  
[francesales@schaffner.com](mailto:francesales@schaffner.com)

### Germany

#### Schaffner Deutschland GmbH

Schoemperlenstrasse 12B  
76185  
Karlsruhe  
+49 721 56910  
[germanysales@schaffner.com](mailto:germanysales@schaffner.com)

### India

#### Schaffner India Pvt. Ltd

Regus World Trade Centre  
WTC, 22nd Floor Unit No 2238, Brigade Gateway Campus, 26/1, Dr. Rajkumar Road Malleshwaram (W)  
560055  
Bangalore  
+91 8067935355  
[indiasales@schaffner.com](mailto:indiasales@schaffner.com)

### Italy

#### Schaffner EMC S.r.l.

Via Ticino, 30  
20900  
Monza (MB)  
+39 039 21 41 070  
[italysales@schaffner.com](mailto:italysales@schaffner.com)

### Japan

#### Schaffner EMC K.K.

ISM Sangenjaya 7F  
1-32-12 Kamiuma, Setagaya-ku  
154-0011  
Tokyo  
+81 3 5712 3650  
[japansales@schaffner.com](mailto:japansales@schaffner.com)

### Singapore

#### Schaffner EMC Pte Ltd.

Blk 3015A Ubi Road 1, #05-09, Kampong Ubi Industrial Estate  
408705  
Singapore  
+65 63773283  
[singaporesales@schaffner.com](mailto:singaporesales@schaffner.com)

### Spain

#### Schaffner EMC España

Calle Caléndula 93, Miniparc III, Edificio E El Soto de Moraleja, Alcobendas  
28109  
Madrid  
+34 917 912 900  
[spainsales@schaffner.com](mailto:spainsales@schaffner.com)

### Sweden

#### Schaffner EMC AB

Östermalmstrorg 1  
114 42  
Stockholm  
+46 8 5050 2425  
[swedensales@schaffner.com](mailto:swedensales@schaffner.com)

### Switzerland

#### Schaffner EMV AG

Industrie Nord  
Nordstrasse 11e  
4542  
Luterbach  
+41 32 681 66 26  
[switzerlandsales@schaffner.com](mailto:switzerlandsales@schaffner.com)

### Taiwan

#### Schaffner EMV Ltd.

U-Town  
20 Floor-2, No 97, Section 1, XinTai 5th Road, XiZhi District  
22175  
New Taipei City  
+886 226975500  
[taiwansales@schaffner.com](mailto:taiwansales@schaffner.com)

### Thailand

#### Schaffner EMC Co. Ltd.

Sathorn Square Tower  
Room 3780, 37FL, 98 North-Sathorn Rd, Silom, Bangrak  
10500  
Bangkok  
+66 621056397  
[thailandsales@schaffner.com](mailto:thailandsales@schaffner.com)

### United Kingdom

#### Schaffner Ltd.

1, Oakmede Place  
Terrace Road  
RG42 4JF  
Binfield  
+44 118 9770070  
[uksales@schaffner.com](mailto:uksales@schaffner.com)

### United States

#### Schaffner EMC Inc.

52 Mayfield Avenue  
Edison, New Jersey  
+1 732 225 9533  
[usasales@schaffner.com](mailto:usasales@schaffner.com)

To find your local partner within Schaffner's global network [schaffner.com](http://schaffner.com)

© 2022 Schaffner Group

The content of this document has been carefully checked and understood. However, neither Schaffner nor its subsidiaries assume any liability whatsoever for any errors or inaccuracies of this document and the consequences thereof. Published specifications are subject to change without notice. Product suitability for any area of application must ultimately be determined by the customer. In all cases, products must never be operated outside their published specifications. Schaffner does not guarantee the availability of all published products. This disclaimer shall be governed by substantive Swiss law and resulting disputes shall be settled by the courts at the place of business of Schaffner Holding AG. Latest publications and a complete disclaimer can be downloaded from the Schaffner website. All trademarks recognized.

# Mouser Electronics

Authorized Distributor

Click to View Pricing, Inventory, Delivery & Lifecycle Information:

## Schaffner:

[RD7127-10-14M0](#) [RD8127-16-12M0](#) [RD8137-50-0M6](#) [RD5122-6-9M6](#) [RD5122-10-6M0](#) [RD5122-16-2M0](#) [RD5132-6-5M0](#) [RD5132-10-3M0](#) [RD5132-16-1M0](#) [RD6127-6-15M0](#) [RD6127-10-9M0](#) [RD6127-16-3M0](#) [RD6137-6-7M5](#) [RD6137-10-4M5](#) [RD6137-16-1M5](#) [RD7127-6-25M0](#) [RD7127-16-5M7](#) [RD7127-25-2M8](#) [RD7127-36-1M0](#) [RD7137-6-12M0](#) [RD7137-10-6M6](#) [RD7137-16-2M8](#) [RD7137-25-1M3](#) [RD7137-36-0M5](#) [RD7147-6-6M0](#) [RD7147-10-3M5](#) [RD7147-16-1M5](#) [RD7147-25-0M7](#) [RD7147-36-0M2](#) [RD8127-25-5M0](#) [RD8127-36-3M0](#) [RD8127-50-1M0](#) [RD8127-64-0M8](#) [RD8137-16-5M0](#) [RD8137-25-2M5](#) [RD8137-36-1M5](#) [RD8137-64-0M5](#) [RD8147-16-3M0](#) [RD8147-25-1M3](#) [RD8147-36-0M8](#) [RD8147-50-0M3](#) [RD8147-64-0M2](#)