

FEATURES

- 8-channel, 24-bit simultaneous sampling ADC**
- Single-ended or true differential inputs**
- PGA per channel (gains of 1, 2, 4, and 8)**
- Low dc input current**
 - ± 4 nA (differential)/ ± 8 nA (single-ended)
- Up to 128 kSPS ODR per channel**
- Programmable ODRs and bandwidth**
- SRC for coherent sampling**
 - Sampling rate resolution up to 15.2×10^{-6} SPS
- Low latency sinc3 and sinc5 filter paths**
- Adjustable phase synchronization**
- Internal 2.5 V reference**
- Two power modes**
 - High resolution mode
 - Low power mode
- Optimizes power dissipation and performance**
- Low resolution SAR ADC for system and chip diagnostics**
- Power supply**
 - Bipolar (± 1.65 V) or unipolar (3.3 V) supplies
 - Digital I/O supply: 1.8 V to 3.6 V
 - Performance temperature range: -40°C to $+105^{\circ}\text{C}$
 - Functional temperature range: -40°C to $+125^{\circ}\text{C}$
- Performance**
 - Combined ac and dc performance
 - 107 dB SNR/dynamic range at 32 kSPS in high resolution mode (sinc5)
 - -109 dB THD
 - ± 8 ppm of FSR INL
 - ± 15 μV offset error
 - $\pm 0.1\%$ FS gain error
 - ± 10 ppm/ $^{\circ}\text{C}$ typical temperature coefficient

APPLICATIONS

- Power quality and measurement applications**
- General-purpose data acquisition**
- Electroencephalography (EEG)**
- Industrial process control**

GENERAL DESCRIPTION

The AD7771¹ is an 8-channel, simultaneous sampling analog-to-digital converter (ADC). Eight full Σ - Δ ADCs are on-chip. The AD7771 provides an ultralow input current to allow direct sensor connection. Each input channel has a programmable gain stage allowing gains of 1, 2, 4, and 8 to map lower amplitude sensor outputs into the full-scale ADC input range, maximizing the dynamic range of the signal chain. The AD7771 accepts a V_{REF}

voltage from 1 V up to 3.6 V. The analog inputs accept unipolar (0 V to V_{REF}) or true bipolar ($\pm V_{\text{REF}}/2$ V) analog input signals with 3.3 V or ± 1.65 V analog supply voltages, respectively. The analog inputs can be configured to accept true differential or single-ended signals to match different sensor output configurations.

Each channel contains an ADC modulator and a sinc3/sinc5, low latency digital filter. A sample rate converter (SRC) is provided to allow fine resolution control over the AD7771 output data rate (ODR). This control can be used in applications where the ODR resolution is required to maintain coherency with 0.01 Hz changes in the line frequency. The SRC is programmable through the serial port interface (SPI). The AD7771 implements two different interfaces: a data output interface and SPI control interface. The ADC data output interface is dedicated to transmitting the ADC conversion results from the AD7771 to the processor. The SPI writes to and reads from the AD7771 configuration registers and for the control and reading of data from the successive approximation register (SAR) ADC. The SPI can also be configured to output the Σ - Δ conversion data.

The AD7771 includes a 12-bit SAR ADC. This ADC can be used for AD7771 diagnostics without having to decommission one of the Σ - Δ ADC channels dedicated to system measurement functions. With the use of an external multiplexer, which can be controlled through the three general-purpose input/output pins (GPIOs), and signal conditioning, the SAR ADC can validate the Σ - Δ ADC measurements in applications where functional safety is required. In addition, the AD7771 SAR ADC includes an internal multiplexer to sense internal nodes.

The AD7771 contains a 2.5 V reference and reference buffer. The reference has a typical temperature coefficient of ± 10 ppm/ $^{\circ}\text{C}$.

The AD7771 offers two modes of operation: high resolution mode and low power mode. High resolution mode provides a higher dynamic range while consuming 16.6 mW per channel; low power mode consumes only 5.25 mW per channel at a reduced dynamic range specification.

The specified operating temperature range is -40°C to $+105^{\circ}\text{C}$, although the device is operational up to $+125^{\circ}\text{C}$.

Note that throughout this data sheet, certain terms are used to refer to either the multifunction pins or a range of pins. The multifunction pins, such as DCLK0/SDO, are referred to either by the entire pin name or by a single function of the pin, for example, DCLK0, when only that function is relevant. In the case of ranges of pins, AVSSx refers to the following pins: AVSS1A, AVSS1B, AVSS2A, AVSS2B, AVSS3, and AVSS4.

¹ This product is protected by at least U.S. Patent No. 9,432,043.

TABLE OF CONTENTS

Features	1	Σ - Δ Output Data.....	54
Applications.....	1	ADC Conversion Output—Header and Data	54
General Description	1	Sample Rate Converter (SRC) (SPI Control Mode)	55
Revision History	3	Data Output Interface.....	57
Functional Block Diagram	4	Calculating the CRC Checksum	61
Specifications.....	5	Register Summary	62
DOUTx Timing Characteristics.....	9	Register Details	66
SPI Timing Characteristics	10	Channel 0 Configuration Register	66
Synchronization Pins and Reset Timing Characteristics	11	Channel 1 Configuration Register	66
SAR ADC Timing Characteristics	12	Channel 2 Configuration Register	67
GPIO SRC Update Timing Characteristics.....	12	Channel 3 Configuration Register	67
Absolute Maximum Ratings.....	13	Channel 4 Configuration Register	68
Thermal Resistance	13	Channel 5 Configuration Register	68
ESD Caution.....	13	Channel 6 Configuration Register	69
Pin Configuration and Function Descriptions.....	14	Channel 7 Configuration Register	69
Typical Performance Characteristics	17	Disable Clocks to ADC Channel Register	70
Terminology	32	Channel 0 Sync Offset Register	70
Theory of Operation	34	Channel 1 Sync Offset Register	70
Analog Inputs.....	34	Channel 2 Sync Offset Register	70
Transfer Function	35	Channel 3 Sync Offset Register	71
Core Signal Chain.....	36	Channel 4 Sync Offset Register	71
Capacitive PGA.....	36	Channel 5 Sync Offset Register	71
Internal Reference and Reference Buffers.....	36	Channel 6 Sync Offset Register	71
Integrated LDOs	37	Channel 7 Sync Offset Register	71
Clocking and Sampling.....	37	General User Configuration 1 Register	72
Digital Reset and Synchronization Pins	37	General User Configuration 2 Register	73
Digital Filtering.....	38	General User Configuration 3 Register.....	74
Shutdown Mode.....	38	Data Output Format Register	74
Controlling the AD7771.....	39	Main ADC Meter and Reference Mux Control Register	75
Pin Control Mode.....	39	Global Diagnostics Mux Register.....	76
SPI Control.....	42	GPIO Configuration Register.....	76
Digital SPI.....	45	GPIO Data Register.....	77
RMS Noise and Resolution.....	48	Buffer Configuration 1 Register	77
High Resolution Mode.....	48	Buffer Configuration 2 Register	77
Low Power Mode.....	49	Channel 0 Offset Upper Byte Register.....	78
Diagnostics and Monitoring	50	Channel 0 Offset Middle Byte Register	78
Self Diagnostics Error	50	Channel 0 Offset Lower Byte Register.....	78
Monitoring Using the AD7771 SAR ADC (SPI Control Mode).....	51	Channel 0 Gain Upper Byte Register.....	78
Σ - Δ ADC Diagnostics (SPI Control Mode).....	53	Channel 0 Gain Middle Byte Register	78
		Channel 0 Gain Lower Byte Register.....	79

Channel 1 Offset Upper Byte Register	79	Channel 6 Gain Lower Byte Register	86
Channel 1 Offset Middle Byte Register.....	79	Channel 7 Offset Upper Byte Register	86
Channel 1 Offset Lower Byte Register	79	Channel 7 Offset Middle Byte Register.....	86
Channel 1 Gain Upper Byte Register.....	79	Channel 7 Offset Lower Byte Register	86
Channel 1 Gain Middle Byte Register.....	80	Channel 7 Gain Upper Byte Register	87
Channel 1 Gain Lower Byte Register.....	80	Channel 7 Gain Middle Byte Register.....	87
Channel 2 Offset Upper Byte Register	80	Channel 7 Gain Lower Byte Register	87
Channel 2 Offset Middle Byte Register.....	80	Channel 0 Status Register	87
Channel 2 Offset Lower Byte Register	80	Channel 1 Status Register	88
Channel 2 Gain Upper Byte Register.....	81	Channel 2 Status Register	88
Channel 2 Gain Middle Byte Register.....	81	Channel 3 Status Register	89
Channel 2 Gain Lower Byte Register.....	81	Channel 4 Status Register	89
Channel 3 Offset Upper Byte Register	81	Channel 5 Status Register	90
Channel 3 Offset Middle Byte Register.....	81	Channel 6 Status Register	90
Channel 3 Offset Lower Byte Register	82	Channel 7 Status Register	91
Channel 3 Gain Upper Byte Register.....	82	Channel 0/Channel 1 DSP Errors Register.....	91
Channel 3 Gain Middle Byte Register.....	82	Channel 2/Channel 3 DSP Errors Register.....	92
Channel 3 Gain Lower Byte Register.....	82	Channel 4/Channel 5 DSP Errors Register.....	92
Channel 4 Offset Upper Byte Register	82	Channel 6/Channel 7 DSP Errors Register.....	93
Channel 4 Offset Middle Byte Register.....	83	Channel 0 to Channel 7 Error Register Enable Register	93
Channel 4 Offset Lower Byte Register	83	General Errors Register 1.....	94
Channel 4 Gain Upper Byte Register.....	83	General Errors Register 1 Enable.....	94
Channel 4 Gain Middle Byte Register.....	83	General Errors Register 2.....	95
Channel 4 Gain Lower Byte Register.....	83	General Errors Register 2 Enable.....	95
Channel 5 Offset Upper Byte Register	84	Error Status Register 1.....	96
Channel 5 Offset Middle Byte Register.....	84	Error Status Register 2.....	96
Channel 5 Offset Lower Byte Register	84	Error Status Register 3.....	97
Channel 5 Gain Upper Byte Register.....	84	Decimation Rate (N) MSB Register	97
Channel 5 Gain Middle Byte Register.....	84	Decimation Rate (N) LSB Register	97
Channel 5 Gain Lower Byte Register.....	85	Decimation Rate (IF) MSB Register.....	97
Channel 6 Offset Upper Byte Register	85	Decimation Rate (IF) LSB Register	98
Channel 6 Offset Middle Byte Register.....	85	SRC Load Source and Load Update Register	98
Channel 6 Offset Lower Byte Register	85	Outline Dimensions.....	99
Channel 6 Gain Upper Byte Register.....	85	Ordering Guide	99
Channel 6 Gain Middle Byte Register.....	86		

REVISION HISTORY

6/2018—Rev. 0 to Rev. A

Changes to I _{AVDD2X} Parameter, Table 1.....	8
Changes to AUXAIN± Parameter, Table 7	13
Changes to Table 13	39
Changes to Phase Adjustment Section	42
Added Table 17; Renumbered Sequentially.....	43

Added Figure 121; Renumbered Sequentially.....	47
Changes to Figure 132 Caption and Figure 133 Caption.....	57
Updated Outline Dimensions.....	99
Changes to Ordering Guide.....	99

6/2017—Revision 0: Initial Version

FUNCTIONAL BLOCK DIAGRAM

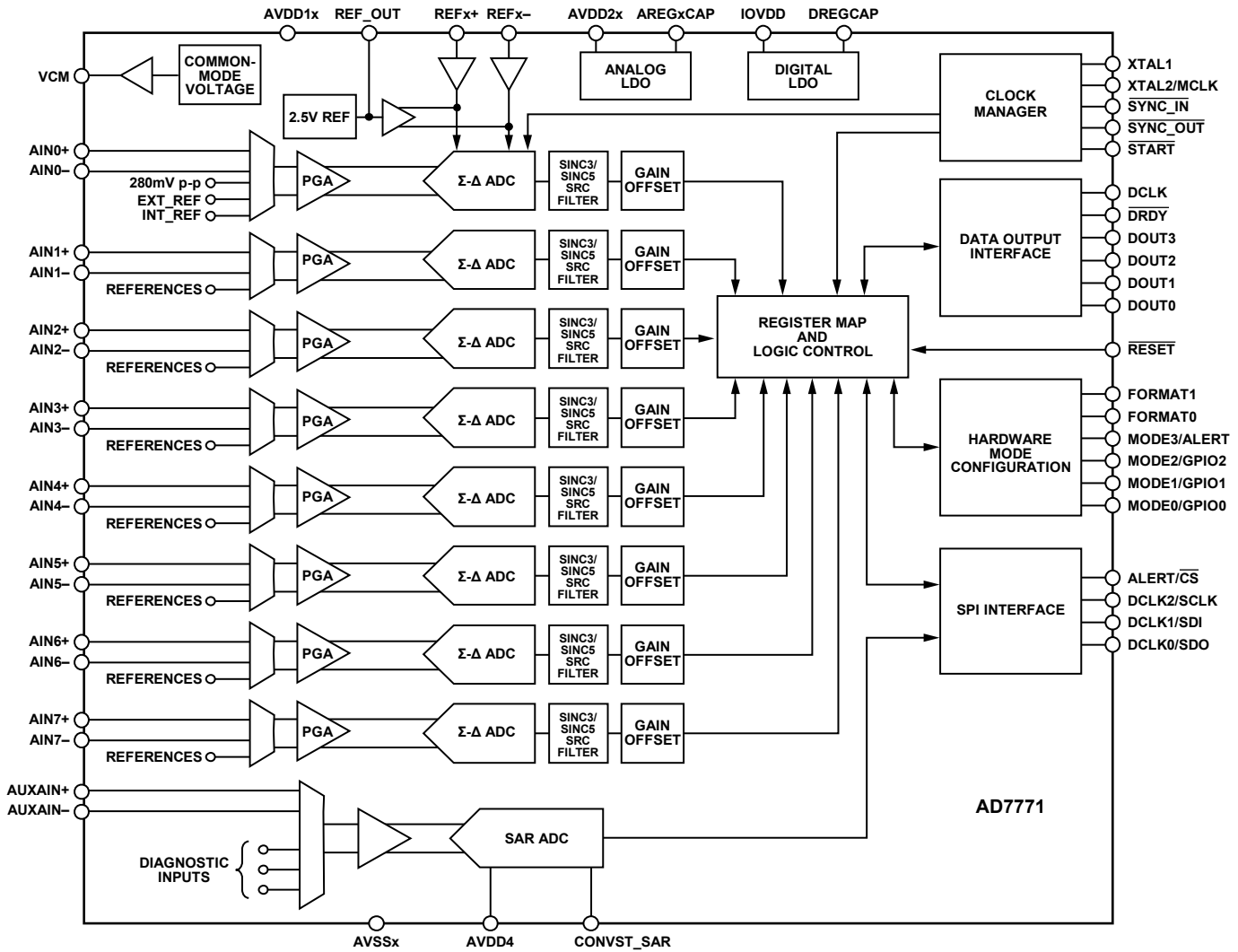

Figure 1.

138102-001

SPECIFICATIONS

AVDD1x = 1.65 V, AVSSx¹ = -1.65 V (dual supply operation), AVDD1x = 3.3 V, AVSSx = analog ground (AGND) (single-supply operation), AVDD2x - AVSSx = 2.2 V to 3.6 V; IOVDD = 1.8 V to 3.6 V; DGND = 0 V, REFx+/REFx- = 2.5 V AVSSx (internal/external), master clock (MCLK) = 8192 kHz for high resolution mode and 4096 kHz for low power mode, ODR = 128 kSPS for high resolution mode and 32 kSPS for low power mode; all specifications at T_{MIN} to T_{MAX}, unless otherwise noted.

Table 1.

Parameter	Test Conditions/Comments	Min	Typ	Max	Unit
ANALOG INPUTS					
Differential Input Voltage Range	V _{REF} = (REFx+ - REFx-)			±V _{REF} /PGA _{GAIN}	V
Single-Ended Input Voltage Range				0 to V _{REF} /PGA _{GAIN}	V
AINx± Common-Mode Input Range		AVSSx + 0.10	(AVDD1x + AVSSx)/2	AVDD1x - 0.10	V
Absolute AINx± Voltage Limits		AVSSx + 0.10		AVDD1x - 0.10	V
DC Input Current					
Differential	High resolution mode		±4		nA
	Low power mode		±1		nA
Single-Ended	High resolution mode		±8		nA
	Low power mode		±2		nA
Input Current Drift			50		pA/°C
AC Input Capacitance			8		pF
PROGRAMMABLE GAIN AMPLIFIER (PGA)					
Gain Settings (PGA _{GAIN})			1, 2, 4, or 8		
Bandwidth					
Small Signal	High resolution mode			2	MHz
	Low power mode			512	kHz
Large Signal	High resolution mode		See Figure 39, Figure 40, and Figure 44		
	Low power mode		See Figure 42, Figure 43, and Figure 47		
REFERENCE					
Internal					
Initial Accuracy	REF_OUT, T _A = 25°C	2.495	2.5	2.505	V
Temperature Coefficient			±10	±38	ppm/°C
Reference Load Current, I _L		-10		+10	mA
DC Power Supply Rejection	Line regulation		95		dB
Load Regulation, ΔV _{OUT} /ΔI _L			100		μV/mA
Voltage Noise, e _{N,p-p}	0.1 Hz to 10 Hz		6.8		μV rms
Voltage Noise Density, e _N	1 kHz, 2.5 V reference		273.5		nV/√Hz
Turn On Settling Time	100 nF		1.5		ms
External					
Input Voltage	V _{REF} = (REFx+ - REFx-)	1	2.5	AVDD1x	V
Buffer Headroom		AVSSx + 0.1		AVDD1x - 0.1	V
REFx- Input Voltage			AVSSx	AVDD1x - REFx+	V
Average REFx± Input Current	Current per channel				
	Reference buffer disabled, high resolution mode		18		μA/V
	Reference buffer precharge mode (pre-Q), high resolution mode		600		nA/V
	Reference buffer disabled, low power mode		4.5		μA/V
	Reference buffer pre-Q, low power mode		100		nA/V
	Reference buffer enabled, high resolution mode		12		nA/V
	Reference buffer enabled, low power mode		5		nA/V

Parameter	Test Conditions/Comments	Min	Typ	Max	Unit
TEMPERATURE RANGE					
Specified Performance	T_{MIN} to T_{MAX}	-40		+105	°C
Functional ²	T_{MIN} to T_{MAX}	-40		+125	°C
TEMPERATURE SENSOR					
Accuracy			±2		°C
DIGITAL FILTER RESPONSE					
Group Delay			See the SRC Group Delay section		
Settling Time			See the Settling Time section		
Pass Band	-0.1 dB -3 dB		See the SRC Bandwidth section See the SRC Bandwidth section		
Decimation Rate					
Sinc3		16		4095.99	
Sinc5		16		2048	
CLOCK SOURCE					
Frequency	High resolution mode Low power mode	0.655 1.3		8.192 4.096	MHz MHz
Duty Cycle		45:55	50:50	55:45	%
Σ-Δ ADC					
Speed and Performance					
Resolution		24			Bits
ODR	High resolution mode Low power mode			128 32	kSPS kSPS
No Missing Codes	Sinc3, up to 24 kSPS Sinc5	24 24			Bits Bits
AC Accuracy					
Dynamic Range	Shorted inputs, $PGA_{GAIN} = 1$				
128 kSPS	High resolution mode (sinc5)		95		dB
32 kSPS	High resolution mode (sinc5)		107		dB
16 kSPS	High resolution mode (sinc3)		105.9		dB
4 kSPS	High resolution mode (sinc3)		116		dB
32 kSPS	Low power mode (sinc5)		94.5		dB
8 kSPS	Low power mode (sinc5)		106.5		dB
8 kSPS	Low power mode (sinc3)		95.8		dB
2 kSPS	Low power mode (sinc3)		111.8		dB
Total Harmonic Distortion (THD)	-0.5 dBFS, high resolution mode -0.5 dBFS, low power mode		-109 -105		dB dB
Signal-to-Noise-and-Distortion Ratio (SINAD)	$f_{IN} = 60$ Hz		106		dB
Spurious-Free Dynamic Range (SFDR)	High resolution mode, 16 kSPS, $PGA_{GAIN} = 1$		132		dB
Intermodulation Distortion (IMD)	$f_A = 50$ Hz, $f_B = 51$ Hz, high resolution mode $f_A = 50$ Hz, $f_B = 51$ Hz, low power mode		-125 -105		dB dB
DC Power Supply Rejection	$AVDD1X = 3.3$ V		-90		dB
DC Common-Mode Rejection Ratio		80			dB
Crosstalk			-120		dB
DC ACCURACY					
Integral Nonlinearity (INL)	Endpoint method				
High Resolution	$PGA_{GAIN} = 1$ Other PGA gains		±8 ±4	±15 ±15	ppm of FSR ppm of FSR

Parameter	Test Conditions/Comments	Min	Typ	Max	Unit
Low Power	PGA _{GAIN} = 1		±9	±17	ppm of FSR
	Other PGA gains		±6	±15	ppm of FSR
Offset Error			±15	±90	μV
Offset Error Drift	Over time		0.25		μV/°C
			–2		μV/1000 hours
Offset Matching			25		μV
Gain Error			±0.1		% FS
Gain Error Drift vs. Temperature	PGA _{GAIN} = 1		±0.75		ppm/°C
Gain Matching			±0.1		%
SAR ADC					
Speed and Performance					
Resolution			12		Bits
Analog Input Range		AVSS4 + 0.1		AVDD4 – 0.1	V
Analog Input Common-Mode Range		AVSS4 + 0.1	(AVDD4 + AVSS4)/2	AVDD4 – 0.1	V
Analog Input Current			±100		nA
Throughput				256	kSPS
DC Accuracy	Differential mode				
INL			±1.5		LSB
Differential Nonlinearity (DNL)	No missing codes (12-bit)	–0.99		1	LSB
Offset			±1		LSB
Gain			12		LSB
AC Performance					
Signal-to-Noise Ratio (SNR)	1 kHz		66		dB
THD	1 kHz		–81		dB
VCM PIN					
Output (V _{CM})			(AVDD1x + AVSSx)/2		V
Load Current, I _L			1		mA
Load Regulation, ΔV _{OUT} /ΔI _L			12		mV/mA
Short-Circuit Current			5		mA
LOGIC INPUTS					
Input Voltage					
High, V _{IH}		0.7 × IOVDD			V
Low, V _{IL}				0.4	V
Hysteresis			0.1		V
Input Currents		–10		+10	μA
LOGIC OUTPUTS³					
Output Voltage					
High, V _{OH}	IOVDD ≥ 3 V, I _{SOURCE} = 1 mA	0.8 × IOVDD			V
	2.3 V ≤ IOVDD < 3 V, I _{SOURCE} = 500 μA	0.8 × IOVDD			V
	IOVDD < 2.3 V, I _{SOURCE} = 200 μA	0.8 × IOVDD			V
Low, V _{OL}	IOVDD ≥ 3 V, I _{SINK} = 2 mA			0.4	V
	2.3 V ≤ IOVDD < 3 V, I _{SINK} = 1 mA			0.4	V
	IOVDD < 2.3 V, I _{SINK} = 100 μA			0.4	V
Leakage Current	Floating state	–10		+10	μA
Output Capacitance	Floating state		10		pF
Σ-Δ ADC Data Output Coding			Twos complement		
SAR ADC Data Output Coding			Binary		

Parameter	Test Conditions/Comments	Min	Typ	Max	Unit
POWER SUPPLIES	All Σ - Δ channels enabled				
AVDD1x – AVSSx		3.0		3.6	V
I_{AVDD1x} ^{4,5}	Reference buffer pre-Q, VCM enabled, internal reference enabled				
	High resolution mode		18.3	23.7	mA
	Low power mode		5	6.4	mA
	Reference buffer enabled, VCM enabled, internal reference enabled				
	High resolution mode		20.5	26.7	mA
	Low power mode		5.5	7.1	mA
	Reference buffer disabled, VCM disabled, internal reference disabled				
	High resolution mode		14.3	18.8	mA
	Low power mode		3.9	5.1	mA
AVDD2x – AVSSx		2.2		3.6	V
I_{AVDD2x}	High resolution mode		9	9.45	mA
	Low power mode		3.5	3.7	mA
AVDD4 – AVSSx		3		3.6	V
I_{AVDD4}	SAR enabled		1.7	2	mA
	SAR disabled		1	10	μ A
AVSSx – DGND		–1.8		0	V
IOVDD – DGND		1.8		3.6	V
I_{IOVDD}	High resolution mode (sinc5)		14.3	17	mA
	Low power mode (sinc5)		4.6	5.5	mA
	High resolution mode (sinc3)		12.2	14.2	mA
	Low power mode (sinc3)		2.2	4.9	mA
Power Dissipation ⁶	Internal buffers bypassed, internal reference disabled, internal oscillator disabled, SAR disabled				
High Resolution Mode	128 kSPS		133	153	mW
Low Power Mode	32 kSPS		42	48.5	mW
Power-Down	All ADCs disabled		530		μ W

¹ AVSSx refers to the following pins: AVSS1A, AVSS1B, AVSS2A, AVSS2B, AVDD3, and AVSS4. This term is used throughout the data sheet.

² At temperatures higher than 105°C, the device can be operated normally, though slight degradation on the maximum/minimum specifications is expected because these specifications are only guaranteed up to 105°C. See the Typical Performance Characteristics section for plots showing the typical performance of the device at high temperatures.

³ The SDO pin and the DOUTx pin are configured in the default mode of strength.

⁴ AVDD1x = 3.3 V, AVSSx = GND = ground, IOVDD = 1.8 V, CMOS clock.

⁵ Disabling either the VCM pin or the internal reference results in a 40 μ A typical current consumption reduction.

⁶ Power dissipation is calculated using the maximum supply voltage, 3.6 V.

DOUTx TIMING CHARACTERISTICS

AVDD1x = 1.65 V, AVSSx¹ = -1.65 V (dual supply operation), AVDD1x = 3.3 V, AVSSx = AGND (single-supply operation), AVDD2 – AVSSx = 2.2 V to 3.6 V; IOVDD = 1.8 V to 3.6 V; DGND = 0 V, REFx+/REFx- = 2.5 V internal/external, MCLK = 8192 kHz; all specifications at T_{MIN} to T_{MAX}, unless otherwise noted.

Table 2.

Parameter	Description ²	Test Conditions/Comments	Min	Typ	Max	Unit
t ₁	MCLK frequency	50:50	0.655		8.192	MHz
t ₂	MCLK low time		60			ns
t ₃	MCLK high time		60			ns
t ₄	DCLK high time	MCLK/2	121			ns
t ₅	DCLK low time	MCLK/2	121			ns
t ₆	MCLK falling edge to DCLK rising edge				45	ns
t ₇	MCLK falling edge to DCLK falling edge				45	ns
t ₈	DCLK rising edge to \overline{DRDY} rising edge		2			ns
t ₉	DCLK rising edge to \overline{DRDY} falling edge		1			ns
t ₁₀	DOUTx setup time		20			ns
t ₁₁	DOUTx hold time		20			ns

¹ AVSSx refers to the following pins: AVSS1A, AVSS1B, AVSS2A, AVSS2B, AVSS3, and AVSS4. This term is used throughout the data sheet.

² All input signals are specified with t_r = t_f = 1 ns/V (10% to 90% of IOVDD) and timed from a voltage level of (V_{IL} + V_{IH})/2.

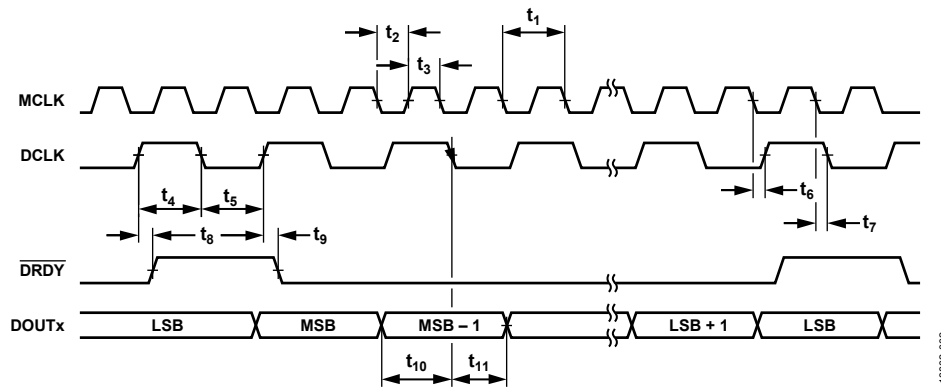

Figure 2. Data Interface Timing Diagram

13802-002

SPI TIMING CHARACTERISTICS

AVDD1x = 1.65 V, AVSSx¹ = -1.65 V (dual supply operation), AVDD1x = 3.3 V, AVSSx = AGND, AVDD2 – AVSSx = 2.2 V to 3.6 V; IOVDD = 1.8 V to 3.6 V; DGND = 0 V, REFx+/REFx- = 2.5 V (internal/external), MCLK = 8192 kHz; all specifications at T_{MIN} to T_{MAX}, unless otherwise noted.

Table 3.

Parameter	Description ²	Test Conditions/Comments	Min	Typ	Max	Unit
t ₁₂	SCLK period	50:50			30	MHz
t ₁₃	SCLK low time		7			ns
t ₁₄	SCLK high time		7			ns
t ₁₅	SCLK rising edge to $\overline{\text{CS}}$ falling edge		10			ns
t ₁₆	$\overline{\text{CS}}$ falling edge to SCLK rising edge		10			ns
t ₁₇	SCLK rising edge to $\overline{\text{CS}}$ rising edge		10			ns
t ₁₈	$\overline{\text{CS}}$ rising edge to SCLK rising edge		10			ns
t ₁₉	Minimum $\overline{\text{CS}}$ high time		10			ns
t ₂₀	SDI setup time		5			ns
t ₂₁	SDI hold time		5			ns
t _{22A}	$\overline{\text{CS}}$ falling edge to SDO enable (SPI = Mode 0)		30			ns
t _{22B}	SCLK falling edge to SDO enable (SPI = Mode 3)		49			ns
t ₂₃	SDO setup time		10			ns
t ₂₄	SDO hold time		10			ns
t ₂₅	$\overline{\text{CS}}$ rising edge to SDO disable		30			ns

¹ AVSSx refers to the following pins: AVSS1A, AVSS1B, AVSS2A, AVSS2B, AVSS3, and AVSS4. This term is used throughout the data sheet.

² All input signals are specified with t_{IR} = t_{IF} = 1 ns/V (10% to 90% of IOVDD) and timed from a voltage level of (V_{IL} + V_{IH})/2.

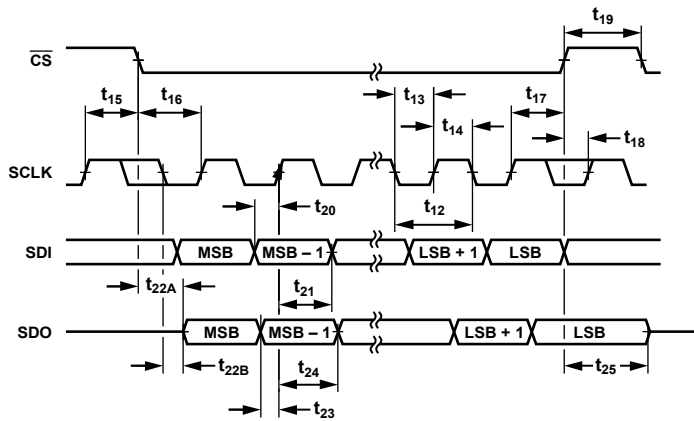

Figure 3. SPI Control Interface Timing Diagram

138102-003

SYNCHRONIZATION PINS AND RESET TIMING CHARACTERISTICS

AVDD1x = 1.65 V, AVSSx¹ = -1.65 V (dual supply operation), AVDD1x = 3.3 V, AVSSx = AGND, AVDD2 – AVSSx = 2.2 V to 3.6 V; IOVDD = 1.8 V to 3.6 V; DGND = 0 V, REFx+/REFx- = 2.5 V (internal/external), MCLK = 8192 kHz; all specifications at T_{MIN} to T_{MAX}, unless otherwise noted.

Table 4.

Parameter	Description ²	Test Conditions/Comments	Min	Typ	Max	Unit
t ₂₆	START setup time		10			ns
t ₂₇	START hold time		MCLK			ns
t ₂₈	MCLK falling edge to SYNC_OUT falling edge		MCLK			ns
t ₂₉	SYNC_IN setup time		10			ns
t ₃₀	SYNC_IN hold time		MCLK			ns
t _{INIT_SYNC_IN}	SYNC_IN rising edge to first DRDY	16 kSPS, high resolution mode	145			μs
t _{INIT_RESET}	RESET rising edge to first DRDY	16 kSPS, high resolution mode	225			μs
t ₃₁	RESET hold time		2 × MCLK			ns
t _{POWER_UP}	Start time	t _{POWER_UP} is not shown in Figure 4		2		ms

¹ AVSSx refers to the following pins: AVSS1A, AVSS1B, AVSS2A, AVSS2B, AVSS3, and AVSS4. This term is used throughout the data sheet.

² All input signals are specified with t_r = t_f = 1 ns/V (10% to 90% of IOVDD) and timed from a voltage level of (V_{IL} + V_{IH})/2.

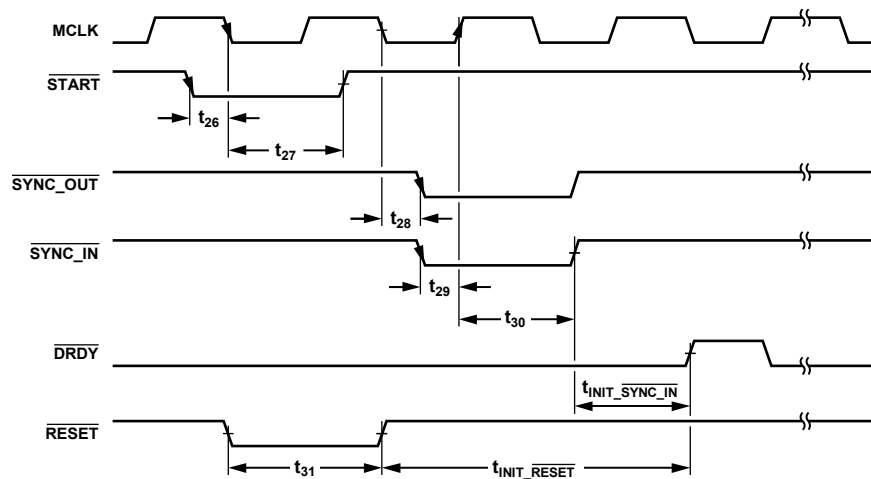

Figure 4. Synchronization Pins and Reset Control Interface Timing Diagram

13802-004

SAR ADC TIMING CHARACTERISTICS

AVDD1x = 1.65 V, AVSSx¹ = -1.65 V (dual supply operation), AVDD1x = 3.3 V, AVSSx = AGND, AVDD2 – AVSSx = 2.2 V to 3.6 V; IOVDD = 1.8 V to 3.6 V; DGND = 0 V, REFx+/REFx- = 2.5 V (internal/external), MCLK = 8192 kHz; all specifications at T_{MIN} to T_{MAX}, unless otherwise noted.

Table 5.

Parameter	Description ²	Min	Typ	Max	Unit
t ₃₂	Conversion time	1		3.4	μs
t ₃₃	Acquisition time ³	500			ns
t ₃₄	Delay time	50			ns
t ₃₅	Throughput data rate			256	kSPS

¹ AVSSx refers to the following pins: AVSS1A, AVSS1B, AVSS2A, AVSS2B, AVSS3 and AVSS4. This term is used throughout the data sheet.

² All input signals are specified with t_r = t_f = 1 ns/V (10% to 90% of IOVDD) and timed from a voltage level of (V_{IL} + V_{IH})/2.

³ Direct mode enabled. If deglitch mode is enabled, add 1.5/MCLK as described in Table 30.



Figure 5. SAR ADC Timing Diagram

GPIO SRC UPDATE TIMING CHARACTERISTICS

AVDD1x = 1.65 V, AVSSx¹ = -1.65 V (dual supply operation), AVDD1x = 3.3 V, AVSSx = AGND, AVDD2 – AVSSx = 2.2 V to 3.6 V; IOVDD = 1.8 V to 3.6 V; DGND = 0 V, REFx+/REFx- = 2.5 V (internal/external), MCLK = 8192 kHz; all specifications T_{MIN} to T_{MAX}, unless otherwise noted.

Table 6.

Parameter	Description ²	Min	Typ	Max	Unit
t ₃₆	GPIO2 setup time	10			ns
t ₃₇	GPIO2 hold time—high resolution mode	MCLK			ns
	GPIO2 hold time—low power mode	2 × MCLK			ns
t ₃₈	MCLK rising edge to GPIO1 rising edge time	20			ns
t ₃₉	GPIO0 setup time	5			ns
t ₄₀	GPIO0 hold time	MCLK			ns

¹ AVSSx refers to the following pins: AVSS1A, AVSS1B, AVSS2A, AVSS2B, AVSS3 and AVSS4. This term is used throughout the data sheet.

² All input signals are specified with t_r = t_f = 1 ns/V (10% to 90% of IOVDD) and timed from a voltage level of (V_{IL} + V_{IH})/2.

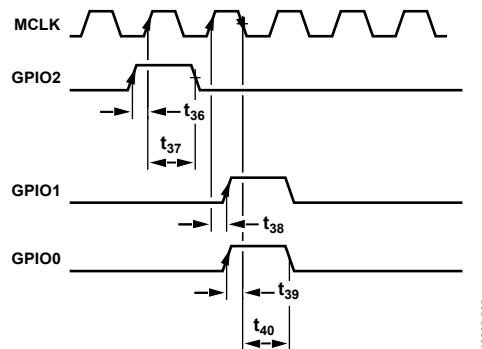

Figure 6. GPIOs for SRC Update Timing Diagram

ABSOLUTE MAXIMUM RATINGS

Table 7.

Parameter	Rating
Any Supply Pin to AVSSx	−0.3 V to +3.96 V
AVSSx to DGND	−1.98 V to +0.3 V
AREGxCAP to AVSSx	−0.3 V to +1.98 V
DREGCAP to DGND	−0.3 V to +1.98 V
IOVDD to DGND	−0.3 V to +3.96 V
IOVDD to AVSSx	−0.3 V to +5.94 V
AVDD4 to AVSSx	−0.3 V to +3.96 V
Analog Input Voltage	AVSSx − 0.3 V to AVDD1x + 0.3 V or 3.96 V (whichever is less)
REFx± Input Voltage	AVSSx − 0.3 V to AVDD1x + 0.3 V or 3.96 V (whichever is less)
AUXAIN±	AVSSx − 0.3 V to AVDD4 + 0.3 V or 3.96 V (whichever is less)
Digital Input Voltage to DGND	DGND − 0.3 V to IOVDD + 0.3 V or 3.96 V (whichever is less)
Digital Output Voltage to DGND	DGND − 0.3 V to IOVDD + 0.3 V or 3.96 V (whichever is less)
XTAL1 to DGND	DGND − 0.3 V to DREGCAP + 0.3 V or 1.98 V (whichever is less)
AINx±, AUXAIN±, and Digital Input Current	±10 mA
Operating Temperature Range	−40°C to +125°C
Junction Temperature, T _J Maximum	150°C
Storage Temperature Range	−65°C to +150°C
Reflow Soldering	260°C
ESD	2 kV
Field Induced Charged Device Model (FICDM)	500 V

Stresses at or above those listed under Absolute Maximum Ratings may cause permanent damage to the product. This is a stress rating only; functional operation of the product at these or any other conditions above those indicated in the operational section of this specification is not implied. Operation beyond the maximum operating conditions for extended periods may affect product reliability.

THERMAL RESISTANCE

Thermal performance is directly linked to printed circuit board (PCB) design and operating environment. Close attention to PCB thermal design is required.

Table 8. Thermal Resistance

Package Type	θ_{JA}	θ_{JB}	Ψ_{JT}	Ψ_{JB}	Unit
CP-64-15 ¹					
No Thermal Vias	30.43	N/A ²	0.13	6.59	°C/W
49 Thermal Vias	22.62	3.17	0.09	3.19	°C/W

¹ Thermal impedance simulated values are based on a JEDEC 2S2P thermal test board. See JEDEC JESD51.

² N/A means not applicable.

ESD CAUTION



ESD (electrostatic discharge) sensitive device. Charged devices and circuit boards can discharge without detection. Although this product features patented or proprietary protection circuitry, damage may occur on devices subjected to high energy ESD. Therefore, proper ESD precautions should be taken to avoid performance degradation or loss of functionality.

PIN CONFIGURATION AND FUNCTION DESCRIPTIONS

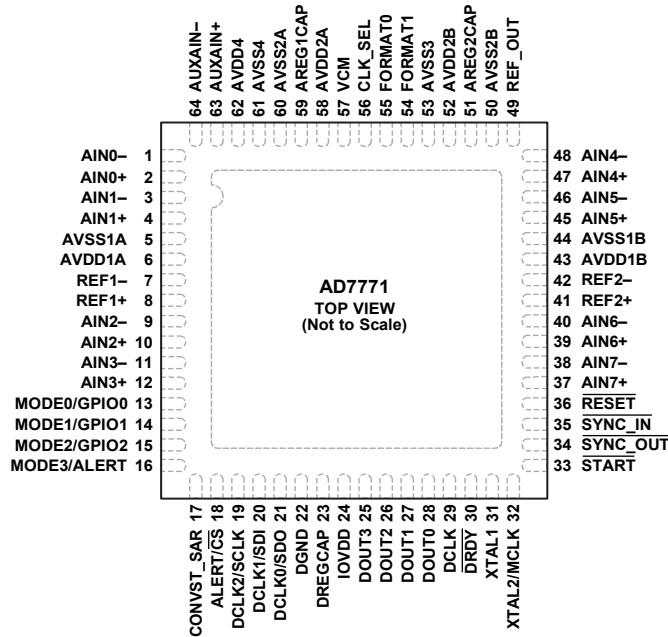

NOTES
1. EXPOSED PAD. CONNECT THE EXPOSED PAD TO AVSSx.

Figure 7. Pin Configuration

Table 9. Pin Function Descriptions

Pin No.	Mnemonic	Type	Direction	Description
1	AIN0-	Analog input	Input	Analog Input Channel 0, Negative.
2	AIN0+	Analog input	Input	Analog Input Channel 0, Positive.
3	AIN1-	Analog input	Input	Analog Input Channel 1, Negative.
4	AIN1+	Analog input	Input	Analog Input Channel 1, Positive.
5	AVSS1A	Supply	Supply	Negative Front-End Analog Supply for Channel 0 to Channel 3, Typical at -1.65 V (Dual Supply) and AGND (Single Supply). Connect all the AVSSx pins to the same potential.
6	AVDD1A	Supply	Supply	Positive Front-End Analog Supply for Channel 0 to Channel 3, Typical at $\text{AVSSx} + 3.3\text{ V}$. Connect this pin to AVDD1B.
7	REF1-	Reference	Input	Negative Reference Input 1 for Channel 0 to Channel 3, Typical at AVSSx. Connect all the REFx- pins to the same potential.
8	REF1+	Reference	Input	Positive Reference Input 1 for Channel 0 to Channel 3, Typical at $\text{REF1-} + 2.5\text{ V}$.
9	AIN2-	Analog input	Input	Analog Input Channel 2, Negative.
10	AIN2+	Analog input	Input	Analog Input Channel 2, Positive.
11	AIN3-	Analog input	Input	Analog Input Channel 3, Negative.
12	AIN3+	Analog input	Input	Analog Input Channel 3, Positive.
13	MODE0/GPIO0	Digital I/O	I/O	Mode 0 Input in Pin Control Mode (MODE0). See Table 14 for more details. Configurable General-Purpose Input/Output 0 in SPI Control Mode (GPIO0). If not in use, connect this pin to DGND or IOVDD.
14	MODE1/GPIO1	Digital I/O	I/O	Mode 1 Input in Pin Control Mode (MODE1). See Table 14 for more details. Configurable General-Purpose Input/Output 1 in SPI Control Mode (GPIO1). If not in use, connect this pin to DGND or IOVDD.
15	MODE2/GPIO2	Digital I/O	I/O	Mode 2 Input in Pin Control Mode (MODE2). See Table 14 for more details. Configurable General-Purpose Input/Output 2 in SPI Control Mode (GPIO2). If not in use, connect this pin to DGND or IOVDD.
16	MODE3/ALERT	Digital I/O	I/O	Mode 3 Input in Pin Control Mode (MODE3). See Table 14 for more details. Alert Output in SPI Control Mode (ALERT).

Pin No.	Mnemonic	Type	Direction	Description
17	CONVST_SAR	Digital input	Input	Σ - Δ Output Interface Selection Pin in Pin Control Mode. See Table 13 for more details. This pin also functions as the start for the SAR conversion in SPI control mode.
18	ALERT/ $\overline{\text{CS}}$	Digital input	Input	Alert Output in Pin Control Mode (ALERT). Chip Select in SPI Control Mode ($\overline{\text{CS}}$).
19	DCLK2/SCLK	Digital input	Input	Data Clock Frequency Selection Pin 2 in Pin Control Mode (DCLK2). See Table 15 for more details. SPI Clock in SPI Control Mode (SCLK).
20	DCLK1/SDI	Digital input	Input	Data Clock Frequency Selection Pin 1 in Pin Control Mode (DCLK1). See Table 15 for more details. SPI Data Input in SPI Control Mode (SDI). Connect this pin to DGND if the device is configured in pin control mode with the SPI as the data output interface.
21	DCLK0/SDO	Digital output	Output	Data Clock Frequency Selection Pin 0 in Pin Control Mode (DCLK0). See Table 15 for more details. SPI Data Output in SPI Control Mode (SDO).
22	DGND	Supply	Supply	Digital Ground.
23	DREGCAP	Supply	Output	Digital Low Dropout (LDO) Output. Decouple this pin to DGND with a 1 μF capacitor.
24	IOVDD	Supply	Supply	Digital Levels Input/Output and Digital LDO (DLDO) Supply from 1.8 V to 3.6 V. IOVDD must not be lower than DREGCAP.
25	DOUT3	Digital output	I/O	Data Output Pin 3. If the device is configured in daisy-chain mode, this pin acts as an input pin. See the Daisy-Chain Mode section for more details.
26	DOUT2	Digital output	I/O	Data Output Pin 2. If the device is configured in daisy-chain mode, this pin acts as an input pin. See the Daisy-Chain Mode section for more details.
27	DOUT1	Digital output	Output	Data Output Pin 1.
28	DOUT0	Digital output	Output	Data Output Pin 0.
29	DCLK	Digital output	Output	Data Output Clock.
30	$\overline{\text{DRDY}}$	Digital output	Output	Data Output Ready Pin.
31	XTAL1	Clock	Input	Crystal 1 Input Connection. If CMOS is used as a clock source, tie this pin to DGND. See Table 12 for more details.
32	XTAL2/MCLK	Clock	Input	Crystal 2 Input Connection (XTAL2). See Table 12 for more details. CMOS Clock (MCLK). See Table 12 for more details.
33	$\overline{\text{START}}$	Digital input	Input	Synchronization Pulse. This pin internally synchronizes an external $\overline{\text{START}}$ asynchronous pulse with MCLK. The synchronize signal is shifted out by the SYNC_OUT pin. If not in use, tie this pin to DGND. See the Phase Adjustment section and the Digital Reset and Synchronization Pins section for more details.
34	$\overline{\text{SYNC_OUT}}$	Digital output	Input	Synchronization Signal. This pin generates a synchronous pulse generated and driven by hardware (via the $\overline{\text{START}}$ pin) or by software (GENERAL_USER_CONFIG_2, Bit 0). If this pin is in use, it must be wired to the SYNC_IN pin. See the Phase Adjustment section and the Digital Reset and Synchronization Pins section for more details.
35	$\overline{\text{SYNC_IN}}$	Digital input	Input	Reset for the Internal Digital Block and Synchronize for Multiple Devices. See the Digital Reset and Synchronization Pins section for more details.
36	$\overline{\text{RESET}}$	Digital input	Input	Asynchronous Reset Pin. This pin resets all registers to their default value. It is recommended to generate a pulse on this pin after the device is powered up because a slow slew rate in the supplies may generate an incorrect initialization in the digital block.
37	AIN7+	Analog input	Input	Analog Input Channel 7, Positive.
38	AIN7-	Analog input	Input	Analog Input Channel 7, Negative.
39	AIN6+	Analog input	Input	Analog Input Channel 6, Positive.
40	AIN6-	Analog input	Input	Analog Input Channel 6, Negative.
41	REF2+	Reference	Input	Positive Reference Input 2 for Channel 4 to Channel 7, Typical at REF2+ + 2.5 V.
42	REF2-	Reference	Input	Negative Reference Input 2 for Channel 4 to Channel 7, Typical at AVSSx. Connect all the REFx- pins to the same potential.
43	AVDD1B	Supply	Supply	Positive Front-End Analog Supply for Channel 4 to Channel 7. Connect this pin to AVDD1A.

Pin No.	Mnemonic	Type	Direction	Description
44	AVSS1B	Supply	Supply	Negative Front-End Analog Supply for Channel 4 to Channel 7, Typical at -1.65 V (Dual Supply) or AGND (Single Supply). Connect all the AVSSx pins to the same potential.
45	AIN5+	Analog input	Input	Analog Input Channel 5, Positive.
46	AIN5-	Analog input	Input	Analog Input Channel 5, Negative.
47	AIN4+	Analog input	Input	Analog Input Channel 4, Positive.
48	AIN4-	Analog input	Input	Analog Input Channel 4, Negative.
49	REF_OUT	Reference	Output	2.5 V Reference Output. Connect a 100 nF capacitor on this pin if using the internal reference.
50	AVSS2B	Supply	Supply	Negative Analog Supply. Connect all the AVSSx pins together.
51	AREG2CAP	Supply	Output	Analog LDO Output 2. Decouple this pin to AVSS2B with a 1 μF capacitor.
52	AVDD2B	Supply	Supply	Positive Analog Supply. Connect this pin to AVDD2A.
53	AVSS3	Supply	Supply	Negative Analog Ground. Connect all the AVSSx to the same potential.
54	FORMAT1	Digital input	Input	Output Data Frame 1. See Table 13 for more details.
55	FORMAT0	Digital input	Input	Output Data Frame 0. See Table 13 for more details.
56	CLK_SEL	Digital input	Input	Select Clock Source. See Table 12 for more details.
57	VCM	Analog output	Output	Common-Mode Voltage Output, Typical at $(\text{AVDD}1\text{x} + \text{AVSSx})/2$.
58	AVDD2A	Supply	Input	Analog Supply from 2.2V to 3.6 V. AVSS2x must not be lower than AREGxCAP. Connect this pin to AVDD2B.
59	AREG1CAP	Supply	Output	Analog LDO Output 1. Decouple this pin to AVSSx with a 1 μF capacitor.
60	AVSS2A	Supply	Input	Negative Analog supply. Connect all the AVSSx pins to the same potential.
61	AVSS4	Supply	Supply	Negative SAR Analog Supply and Reference. Connect all AVSSx pins to the same potential.
62	AVDD4	Supply	Supply	Positive SAR Analog Supply and Reference Source.
63	AUXAIN+	Analog input	Input	Positive SAR Analog Input Channel.
64	AUXAIN-	Analog input	Input	Negative SAR Analog Input Channel.
	EPAD	Supply	Input	Exposed Pad. Connect the exposed pad to AVSSx.

TYPICAL PERFORMANCE CHARACTERISTICS

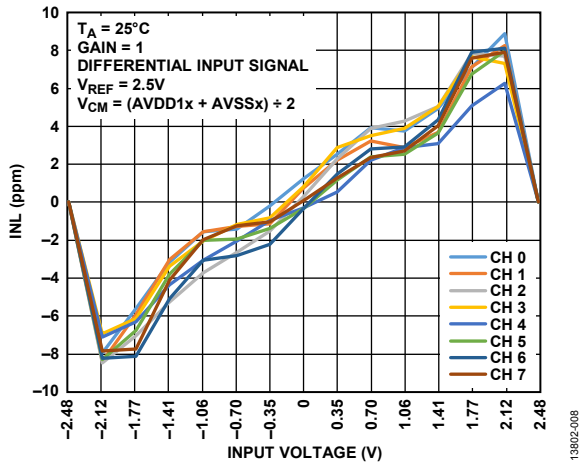

Figure 8. INL vs. Input Voltage and Channel at 64 kSPS, High Resolution Mode

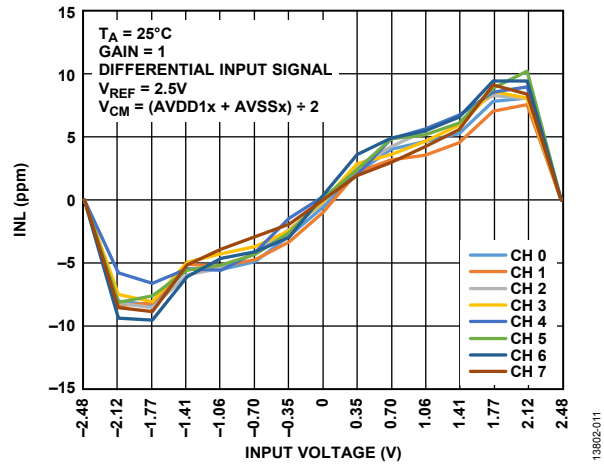

Figure 11. INL vs. Input Voltage and Channel at 16 kSPS, Low Power Mode

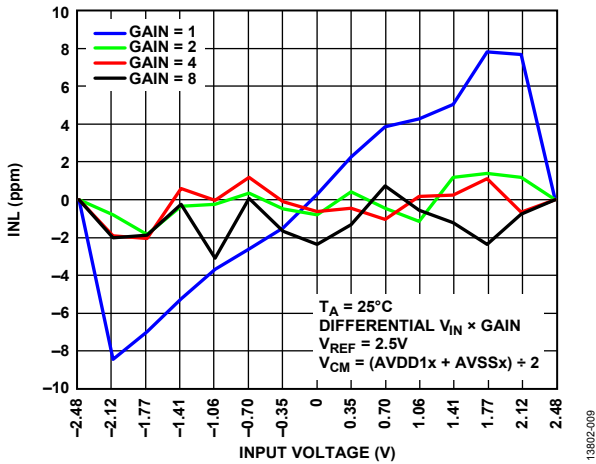

Figure 9. INL vs. Input Voltage and PGA Gain at 64 kSPS, High Resolution Mode

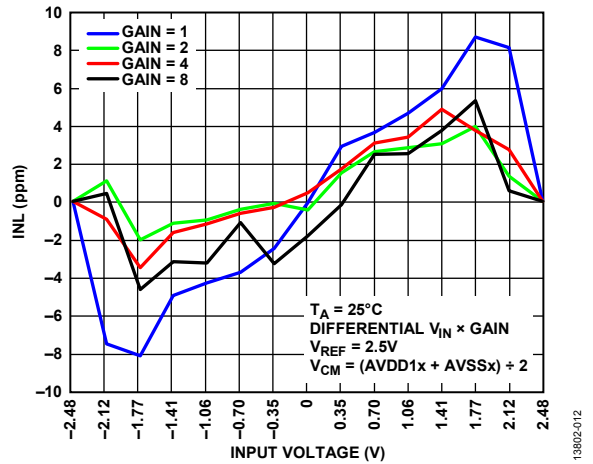

Figure 12. INL vs. Input Voltage and PGA Gain at 16 kSPS, Low Power Mode

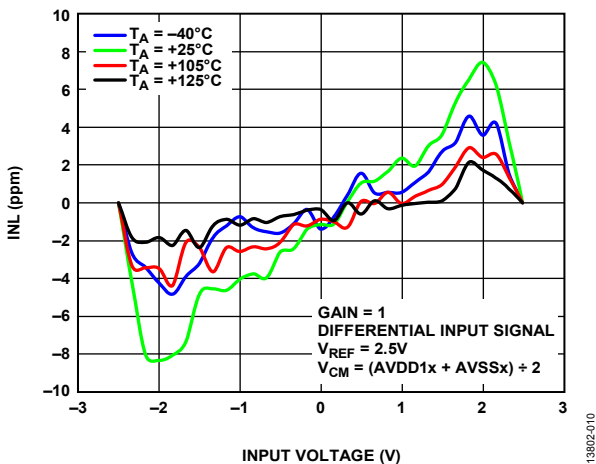

Figure 10. INL vs. Input Voltage and Temperature at 64 kSPS, High Resolution Mode

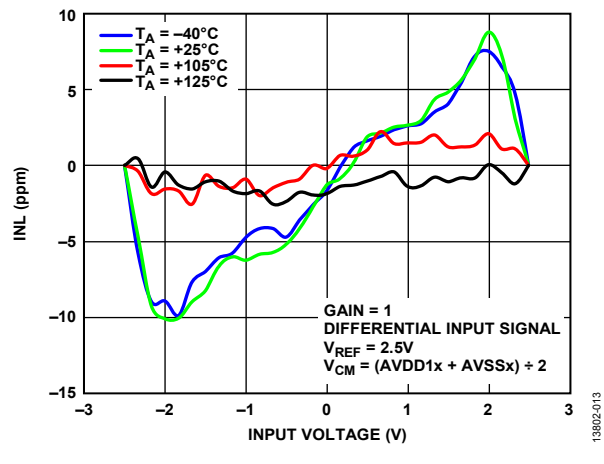

Figure 13. INL vs. Input Voltage and Temperature at 16 kSPS, Low Power Mode

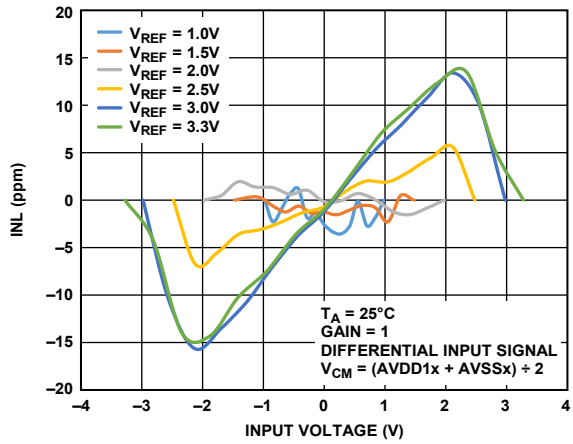

Figure 14. INL vs. Input Voltage and Reference Voltage (V_{REF}) at 64 kSPS, High Resolution Mode

13802-014

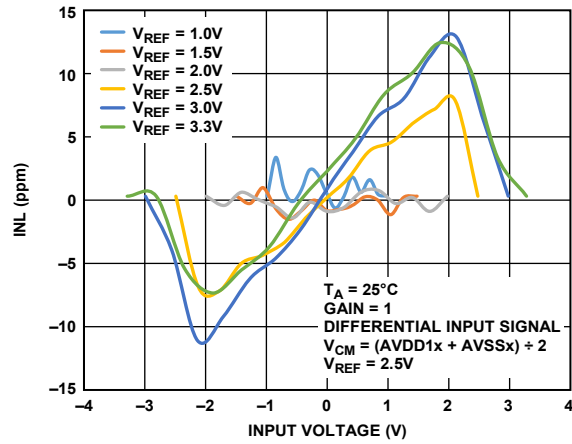

Figure 17. INL vs. Input Voltage and Reference Voltage (V_{REF}) at 16 kSPS, Low Power Mode

13802-017

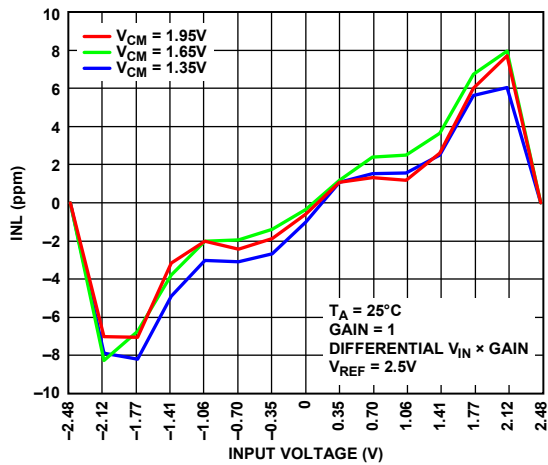

Figure 15. INL vs. Input Voltage and V_{CM} at 64 kSPS, High Resolution Mode

13802-015

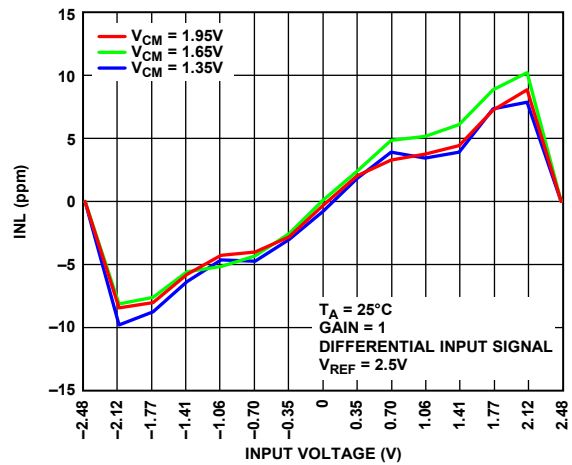

Figure 18. INL vs. Input Voltage and V_{CM} at 16 kSPS, Low Power Mode

13802-018

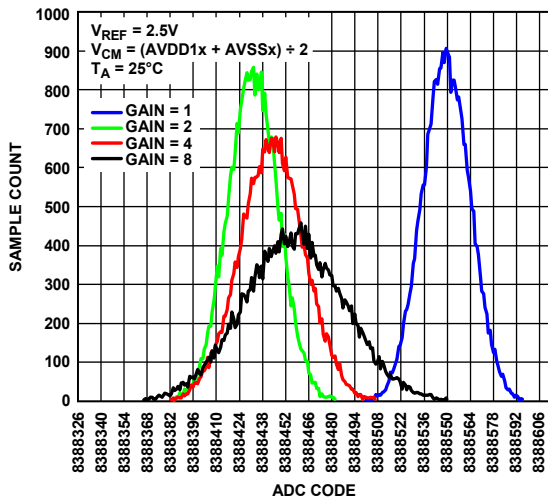

Figure 16. Noise Histogram at 16 kSPS, High Resolution Mode, Sinc3 Filter Enabled

13802-016

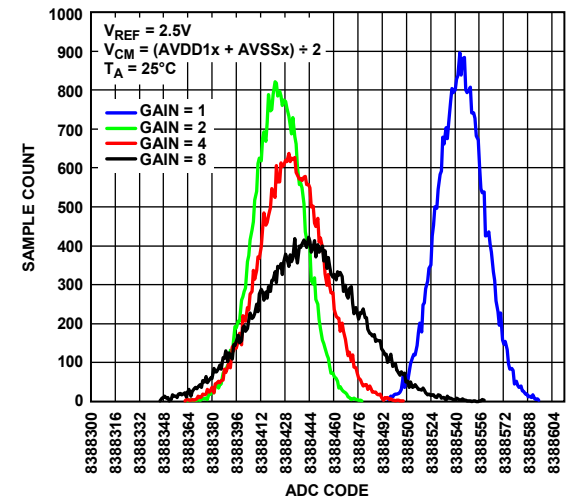

Figure 19. Noise Histogram at 4 kSPS, Low Power Mode, Sinc3 Filter Enabled

13802-019

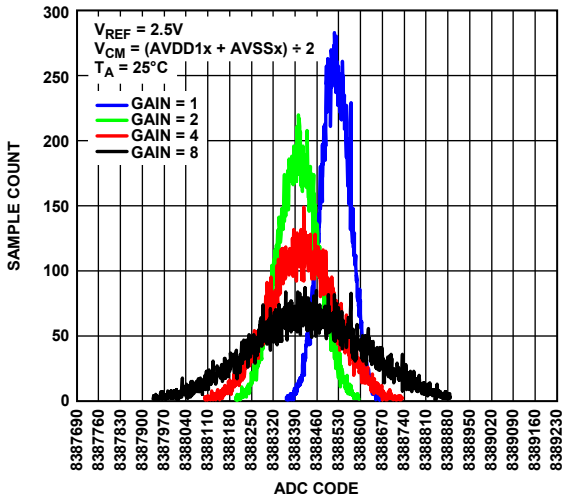

Figure 20. Noise Histogram at 64 kSPS, High Resolution Mode, Sinc5 Filter Enabled

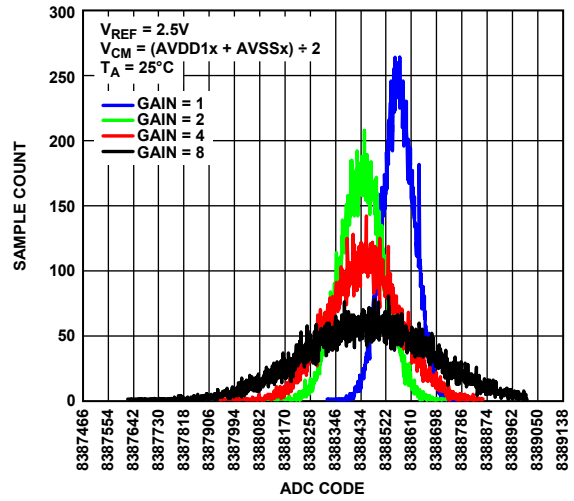

Figure 23. Noise Histogram at 16 kSPS, Low Power Mode, Sinc5 Filter Enabled

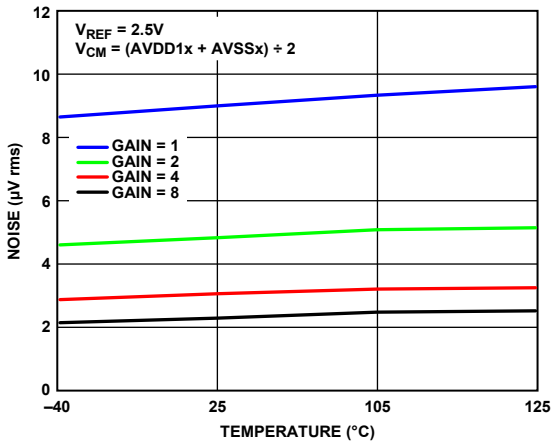

Figure 21. Noise vs. Temperature at 16 kSPS, High Resolution Mode, Sinc3 Filter Enabled

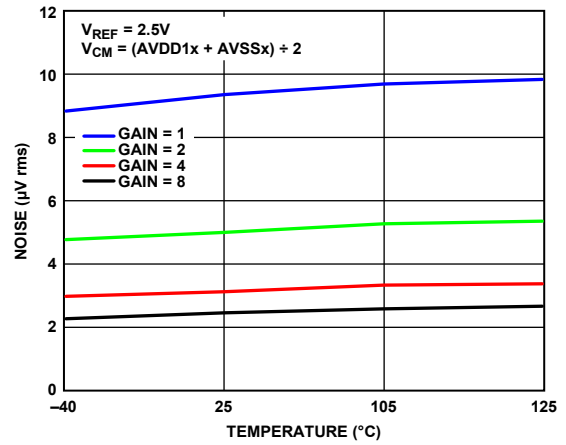

Figure 24. Noise vs. Temperature at 4 kSPS, Low Power Mode, Sinc3 Filter Enabled

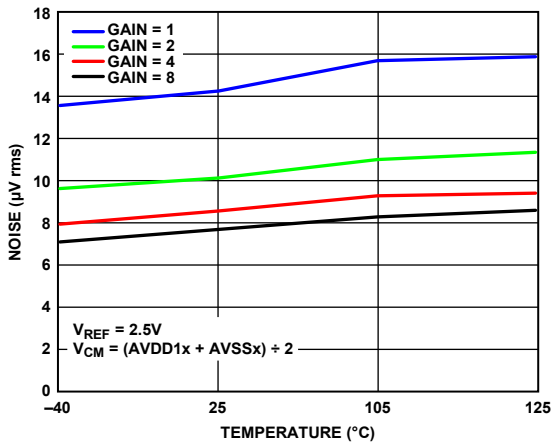

Figure 22. Noise vs. Temperature at 64 kSPS, High Resolution Mode, Sinc5 Filter Enabled

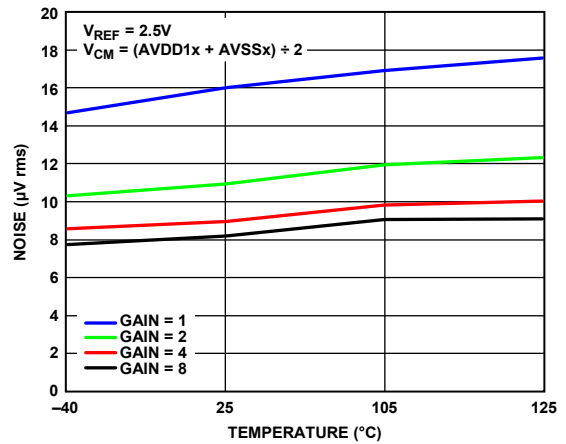

Figure 25. Noise vs. Temperature at 16 kSPS, Low Power Mode, Sinc5 Filter Enabled

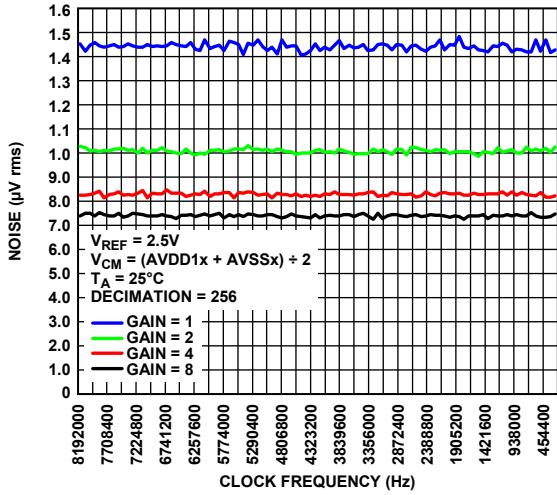

Figure 26. Noise vs. Clock Frequency, High Resolution Mode

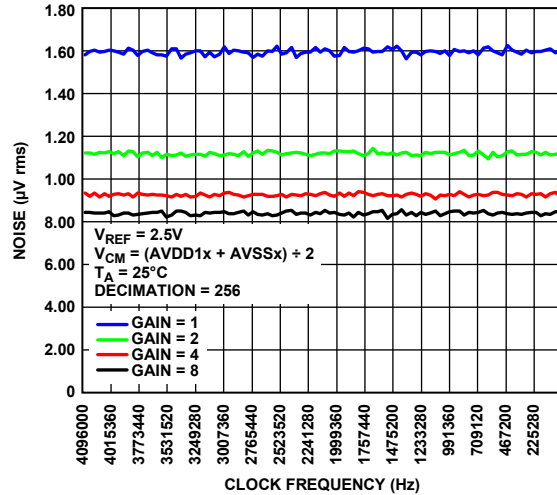

Figure 29. Noise vs. Clock Frequency, Low Power Mode

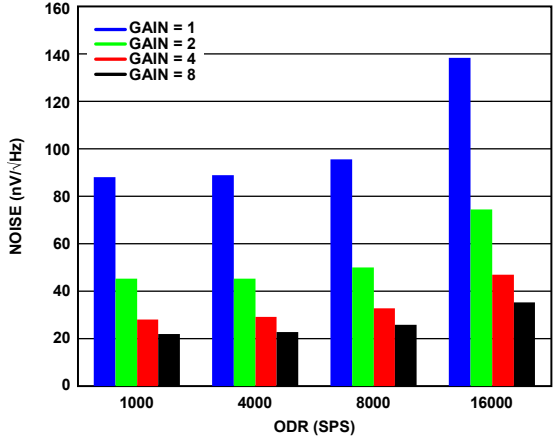

Figure 27. Noise vs. ODR, High Resolution Mode, Sinc3 Filter Enabled

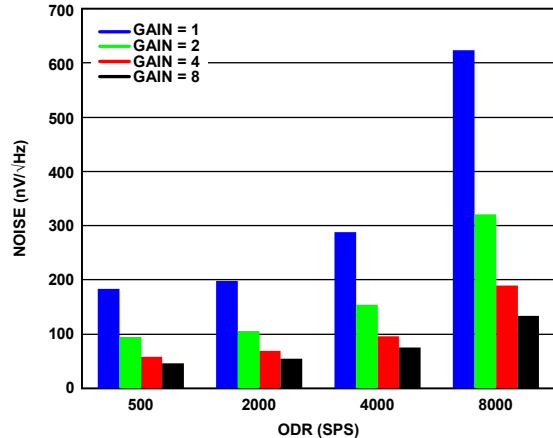

Figure 30. Noise vs. ODR, Low Power Mode, Sinc3 Filter Enabled

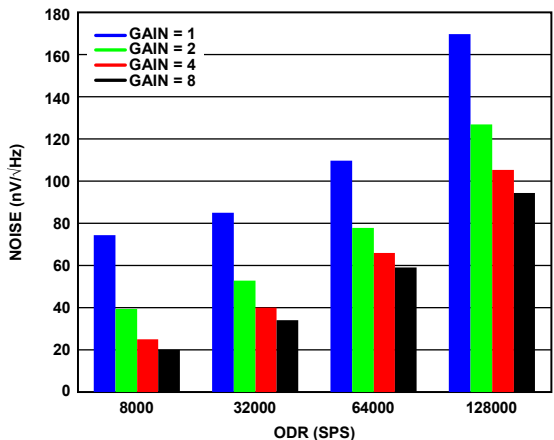

Figure 28. Noise vs. ODR, High Resolution Mode, Sinc5 Filter Enabled

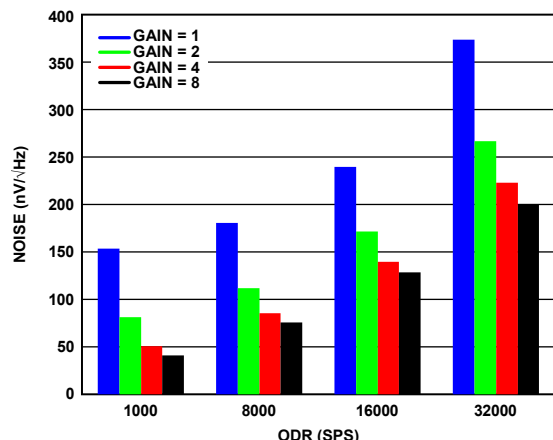

Figure 31. Noise vs. ODR, Low Power Mode, Sinc5 Filter Enabled

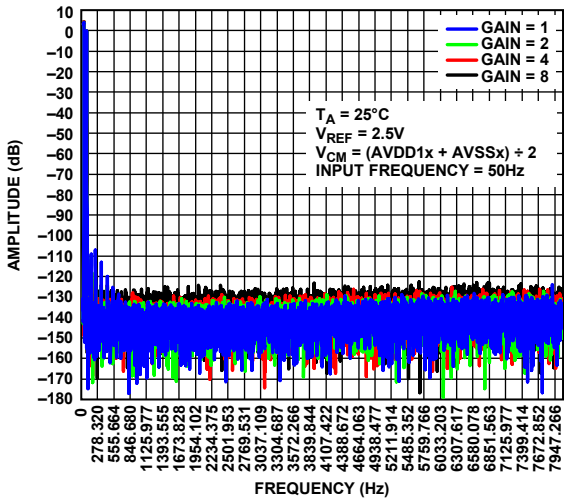

Figure 32. FFT Plot, High Resolution Mode at 16 kSPS, Input Frequency (f_{IN}) = 50 Hz, Sinc3 Filter Enabled

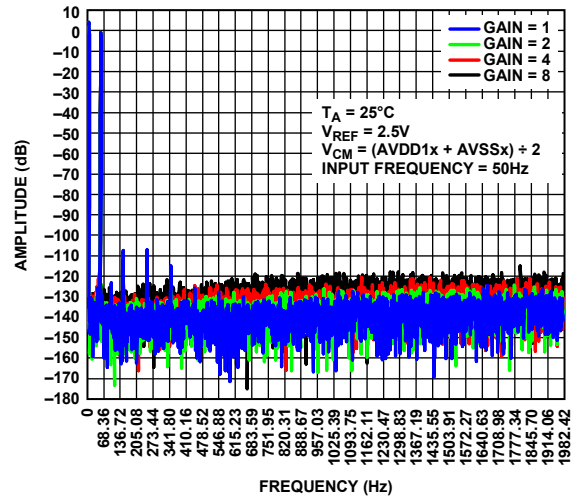

Figure 35. FFT Plot, Low Power Mode at 4 kSPS, Input Frequency (f_{IN}) = 50 Hz, Sinc3 Filter Enabled

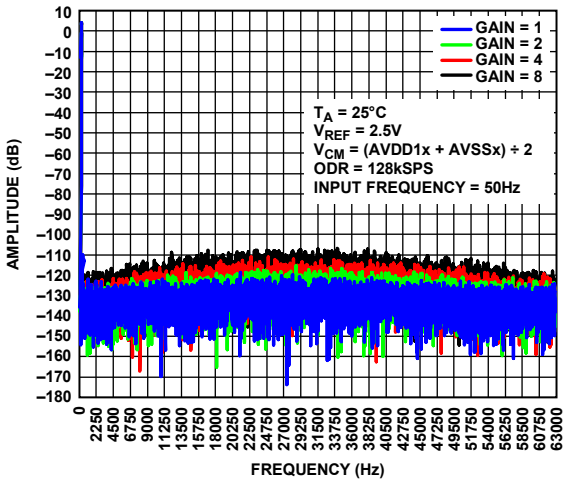

Figure 33. FFT Plot, High Resolution Mode at 128 kSPS, Input Frequency (f_{IN}) = 50 Hz, Sinc5 Filter Enabled

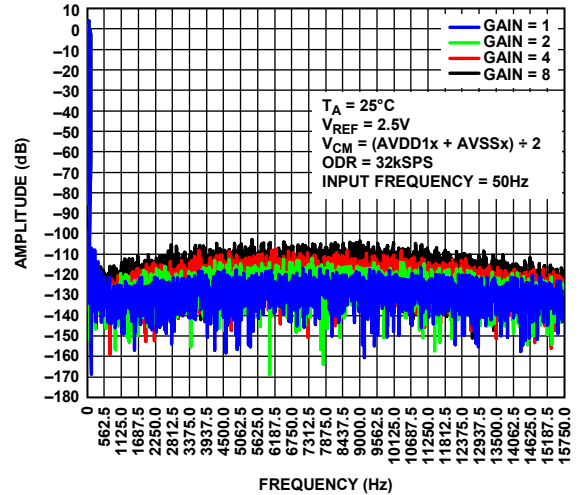

Figure 36. FFT Plot, Low Power Mode at 32 kSPS, Input Frequency (f_{IN}) = 50 Hz, Sinc5 Filter Enabled

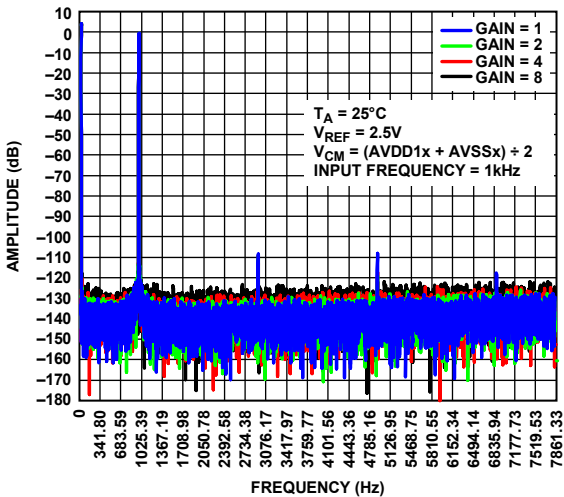

Figure 34. FFT Plot, High Resolution Mode at 16 kSPS, Input Frequency (f_{IN}) = 1 kHz, Sinc3 Filter Enabled

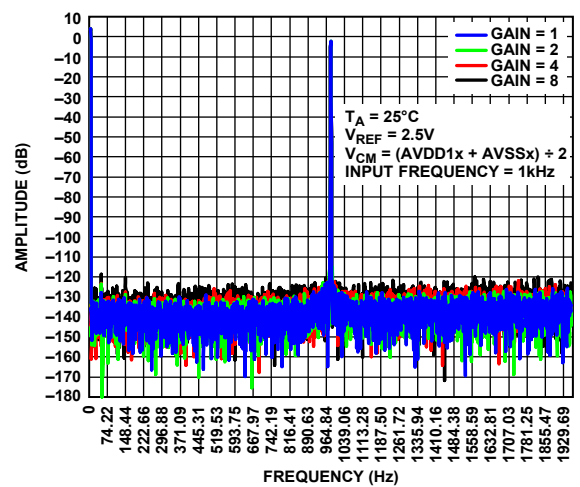

Figure 37. FFT Plot, Low Power Mode at 4 kSPS, Input Frequency (f_{IN}) = 1 kHz, Sinc3 Filter Enabled

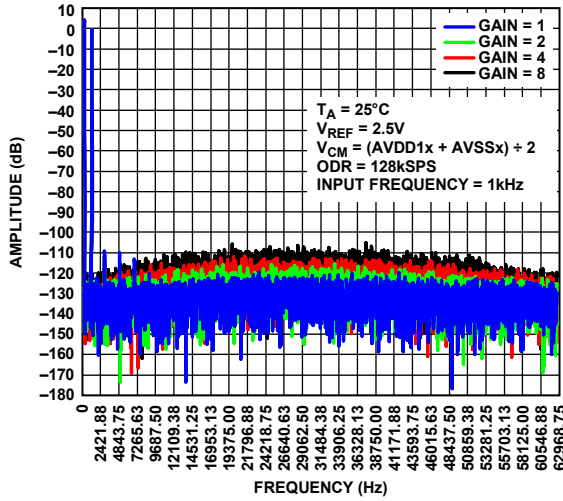

Figure 38. FFT Plot, High Resolution Mode at 128 kSPS, Input Frequency (f_{IN}) = 1 kHz, Sinc5 Filter Enabled

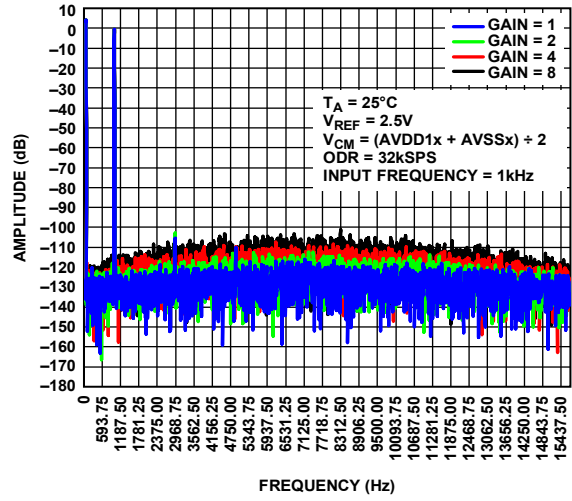

Figure 41. FFT Plot, Low Power Mode at 32 kSPS, Input Frequency (f_{IN}) = 1 kHz, Sinc5 Filter Enabled

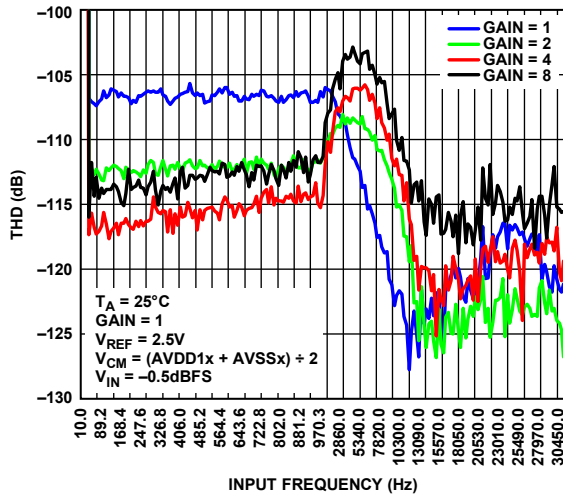

Figure 39. THD vs. Input Frequency at 64 kSPS, High Resolution Mode, Sinc5 Filter Enabled

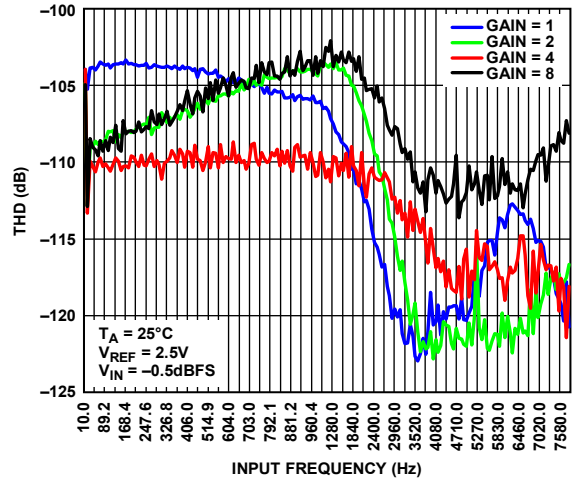

Figure 42. THD vs. Input Frequency at 16 kSPS, Low Power Mode, Sinc5 Filter Enabled

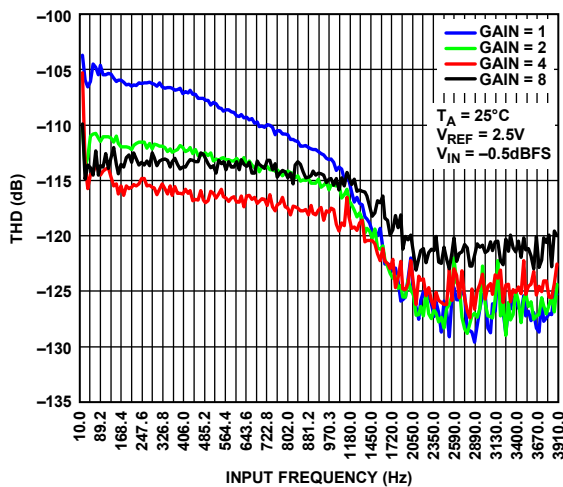

Figure 40. THD vs. Input Frequency at 16 kSPS, High Resolution Mode, Sinc3 Filter Enabled

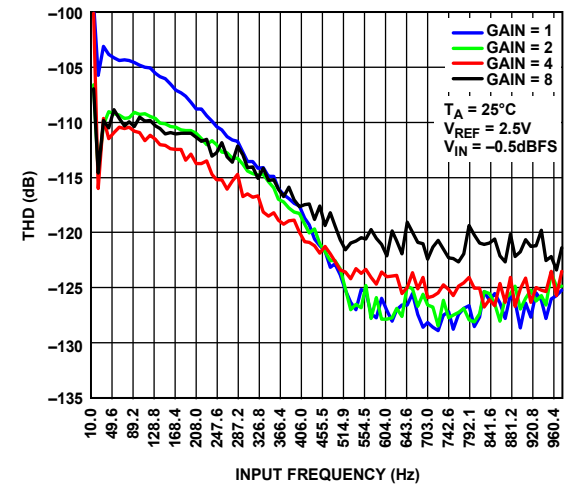

Figure 43. THD vs. Input Frequency at 4 kSPS, Low Power Mode, Sinc3 Filter Enabled

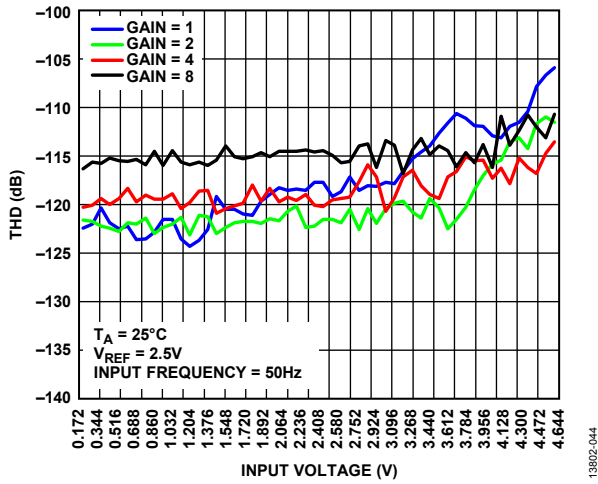

Figure 44. THD vs. Input Voltage at 64 kSPS, High Resolution Mode

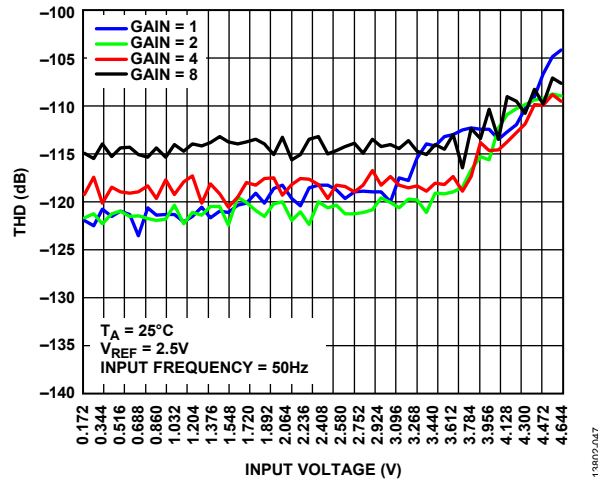

Figure 47. THD vs. Input Voltage at 16 kSPS, Low Power Mode

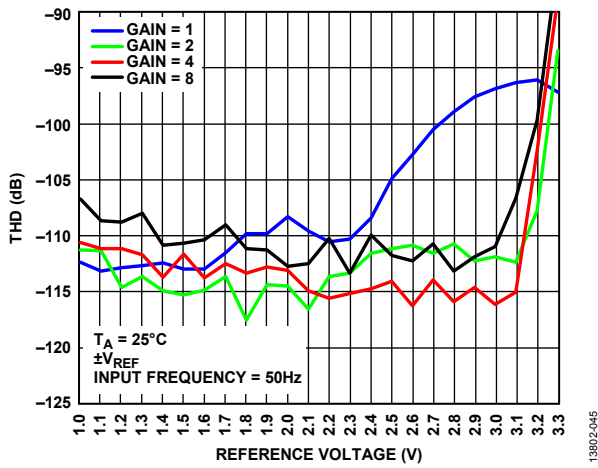

Figure 45. THD vs. Reference Voltage at 64 kSPS, High Resolution Mode

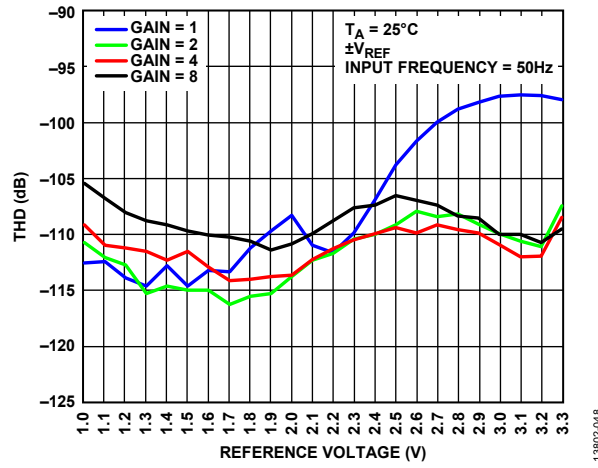

Figure 48. THD vs. Reference Voltage at 16 kSPS, Low Power Mode

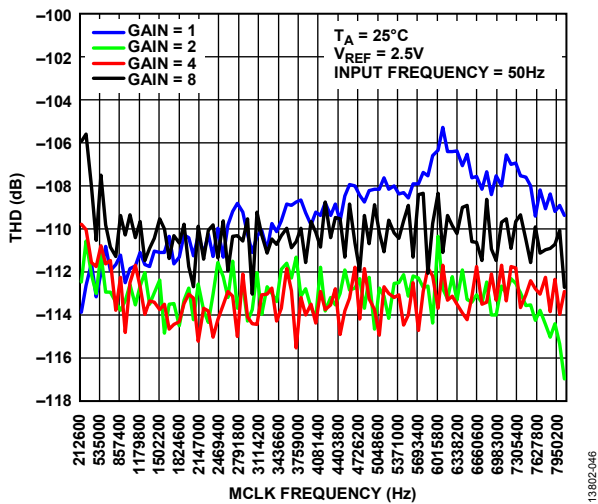

Figure 46. THD vs. Master Clock Frequency, High Resolution Mode

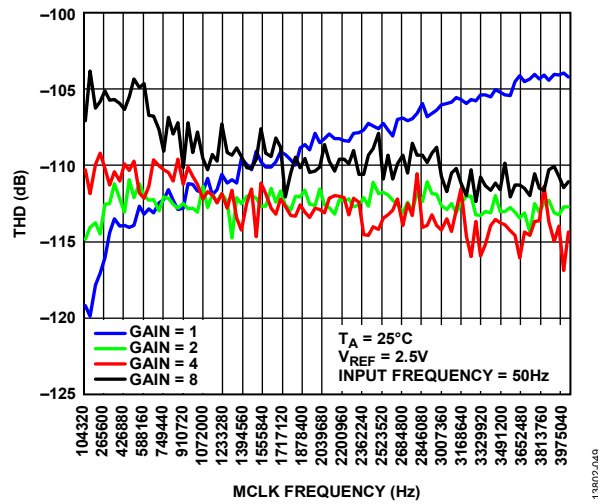

Figure 49. THD vs. Master Clock Frequency, Low Power Mode

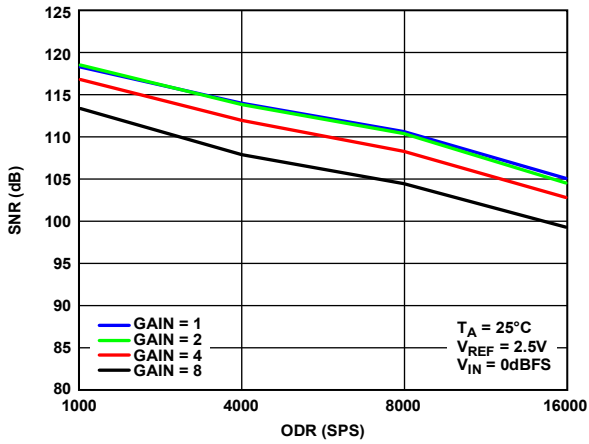

Figure 50. SNR vs. ODR at 16 kSPS, High Resolution Mode (AVDDx = 3.6 V, IOVDD = 3.6 V)

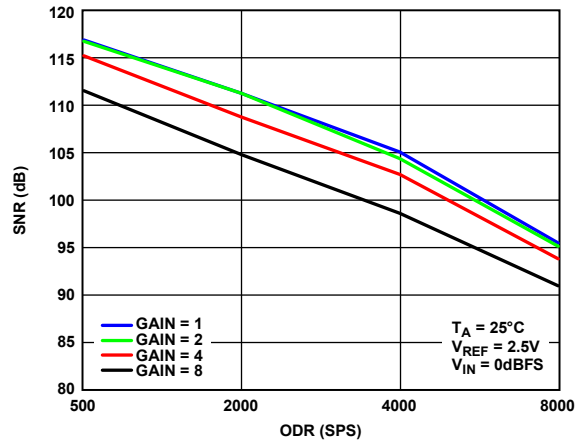

Figure 53. SNR vs. ODR at 4 kSPS, Low Power Mode (AVDDx = 3.6 V, IOVDD = 3.6 V)

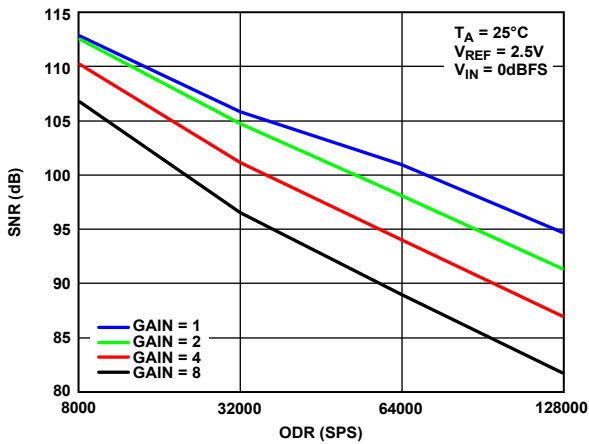

Figure 51. SNR vs. ODR at 64 kSPS, High Resolution Mode (AVDDx = 3.6 V, IOVDD = 3.6 V)

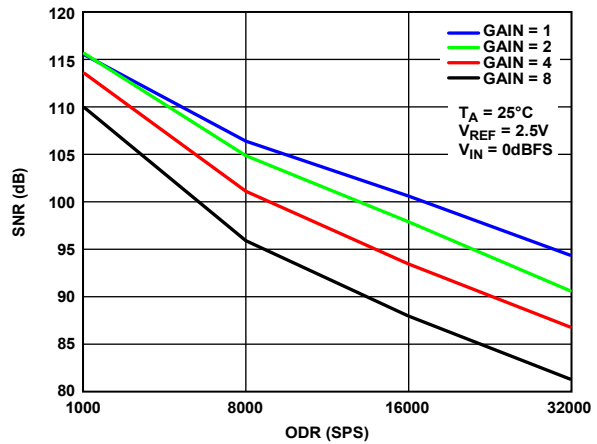

Figure 54. SNR vs. ODR at 16 kSPS, Low Power Mode (AVDDx = 3.6 V, IOVDD = 3.6 V)

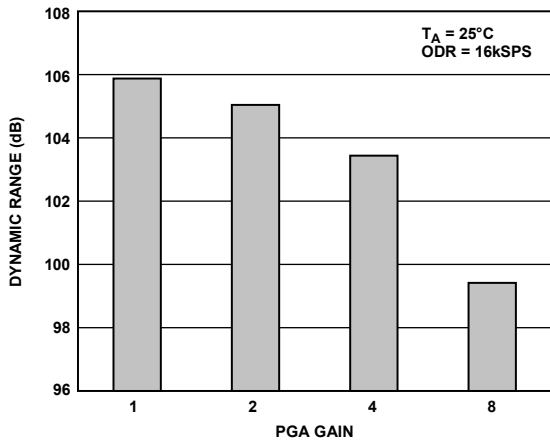

Figure 52. Dynamic Range vs. PGA Gain at 16 kSPS, High Resolution Mode

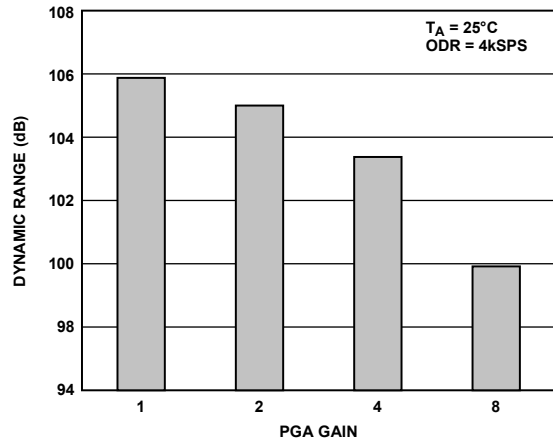

Figure 55. Dynamic Range vs. PGA Gain at 4 kSPS, Low Power Mode

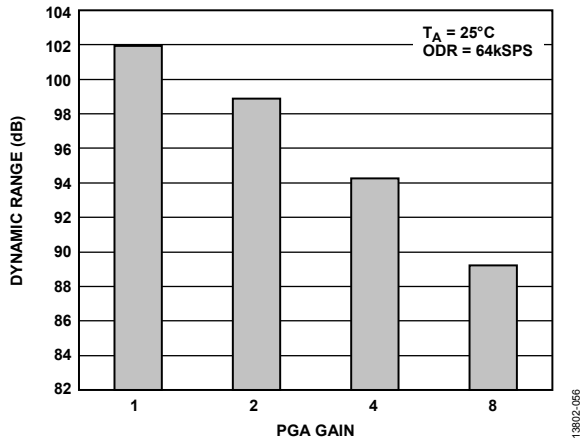

Figure 56. Dynamic Range vs. PGA Gain at 64 kSPS, High Resolution Mode

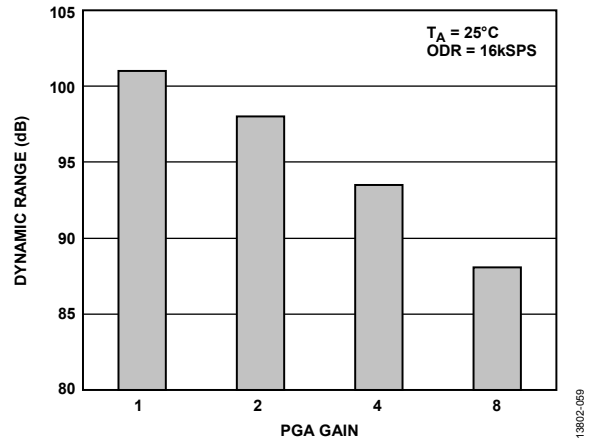

Figure 59. Dynamic Range vs. PGA Gain at 16 kSPS, Low Power Mode

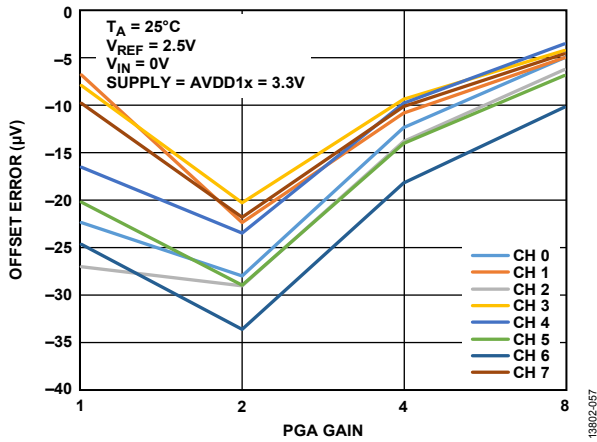

Figure 57. Offset Error vs. PGA Gain at 64 kSPS, High Resolution Mode

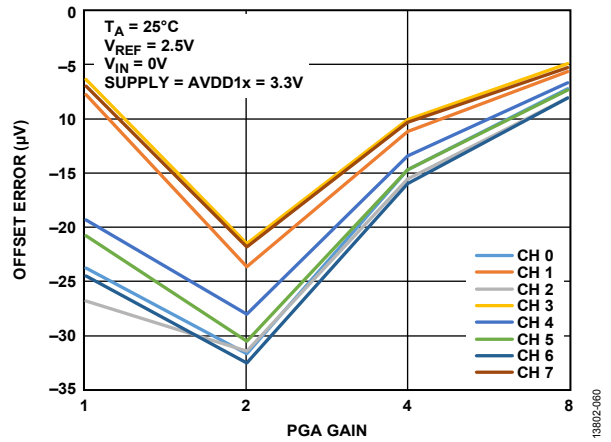

Figure 60. Offset Error vs. PGA Gain at 16 kSPS, Low Power Mode

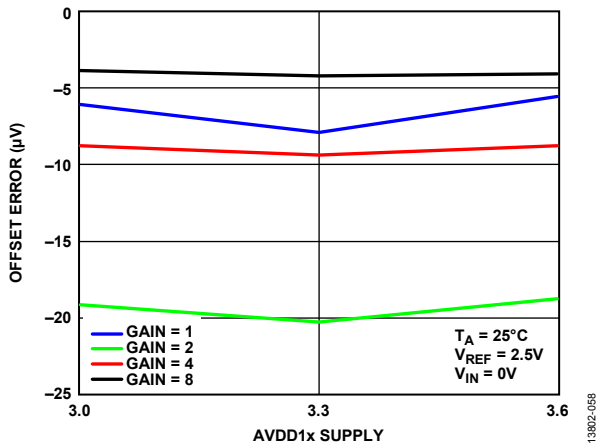

Figure 58. Offset Error vs. AVDD1x Supply, High Resolution Mode

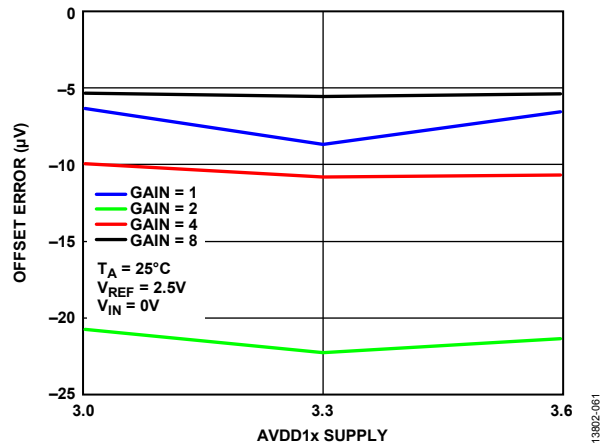

Figure 61. Offset Error vs. AVDD1x Supply, Low Power Mode

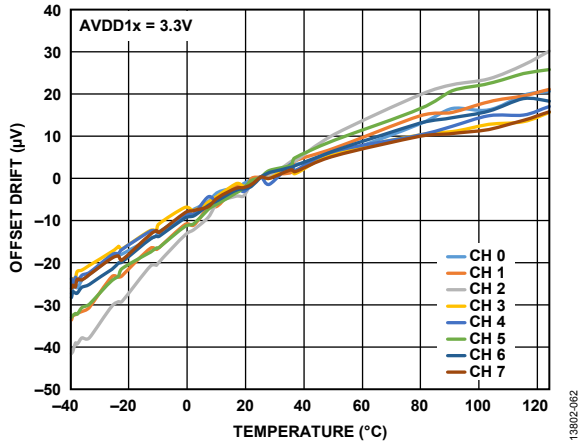

Figure 62. Offset Drift vs. Temperature

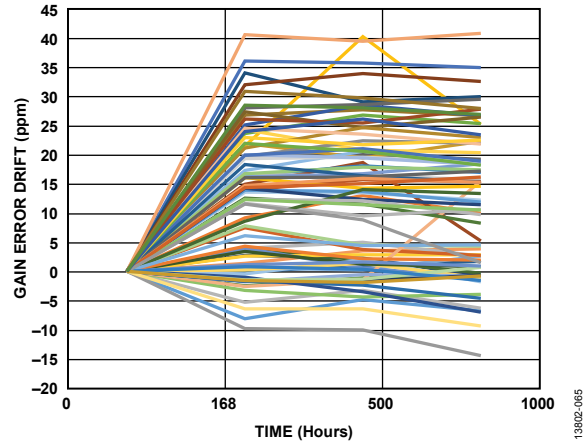

Figure 65. Gain Error Drift vs. Time

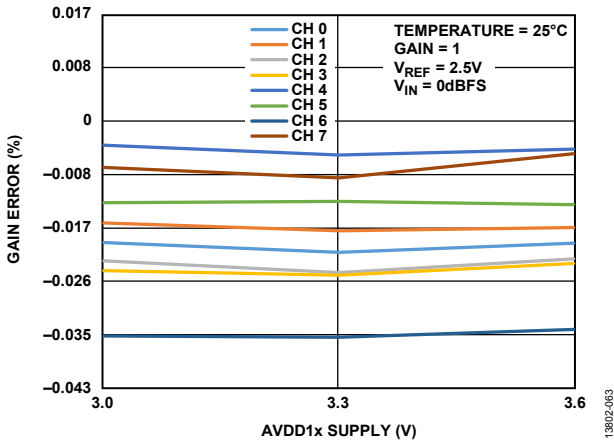

Figure 63. Gain Error vs. AVDD1x Supply, High Resolution Mode

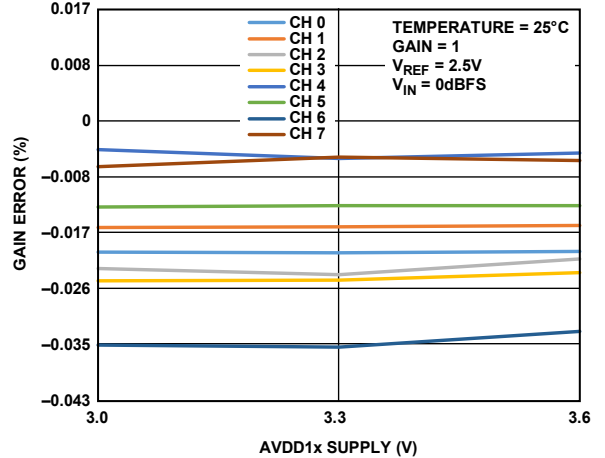

Figure 66. Gain Error vs. AVDD1x Supply, Low Power Mode

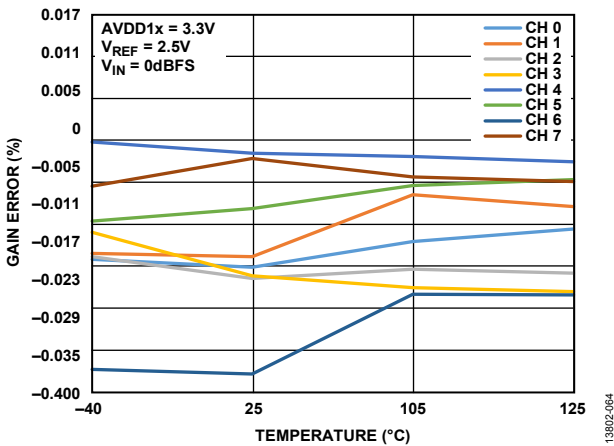

Figure 64. Gain Error vs. Temperature, High Resolution Mode

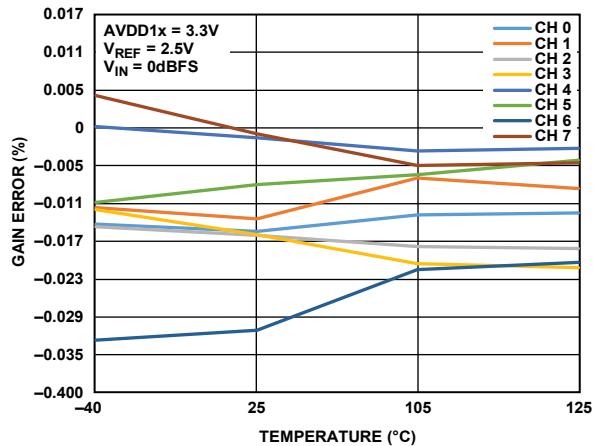

Figure 67. Gain Error vs. Temperature, Low Power Mode

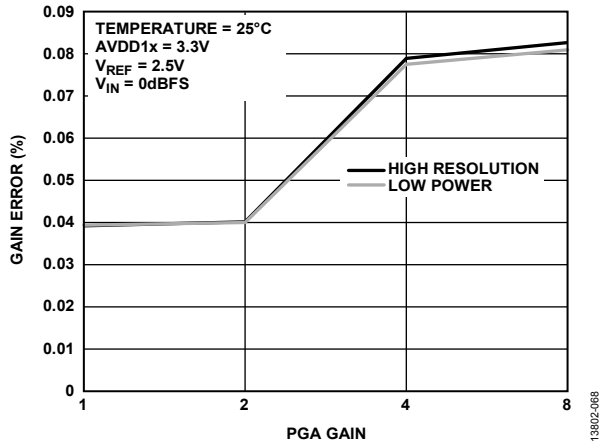

Figure 68. Channel Gain Mismatch

13802-068

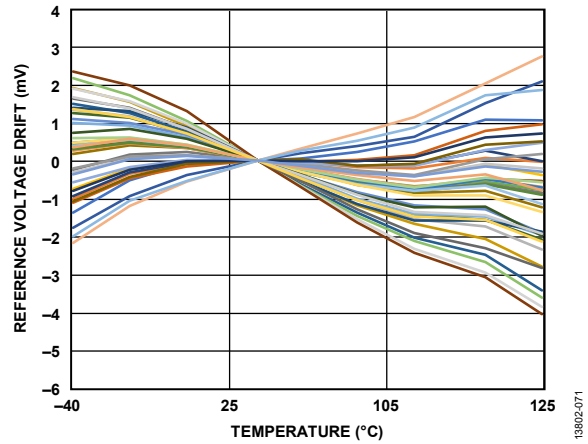

Figure 71. Internal Reference Voltage Drift

13802-071

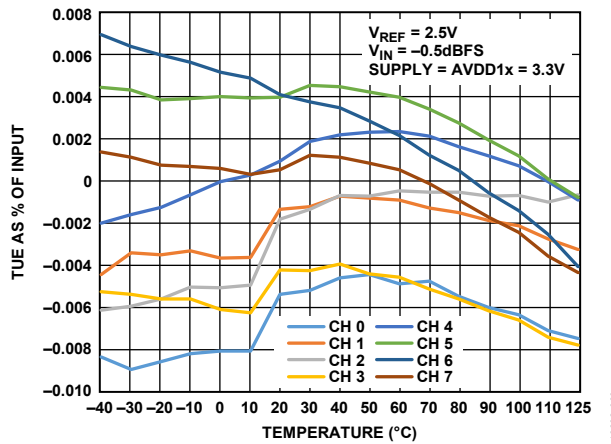

Figure 69. Total Unadjusted Error (TUE) (as Percent of Input) vs. Temperature, High Resolution Mode

13802-069

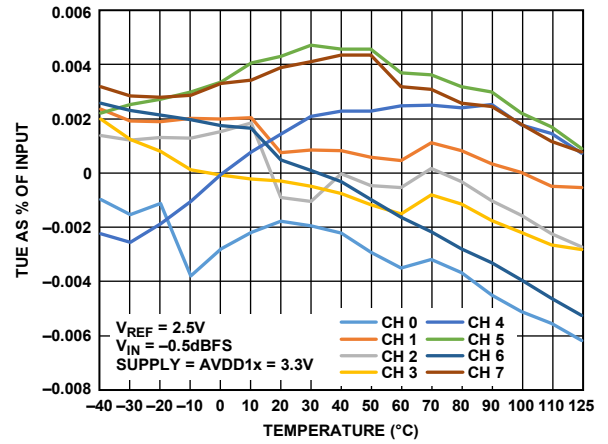

Figure 72. Total Unadjusted Error (TUE) (as Percent of Input) vs. Temperature, Low Power Mode

13802-072

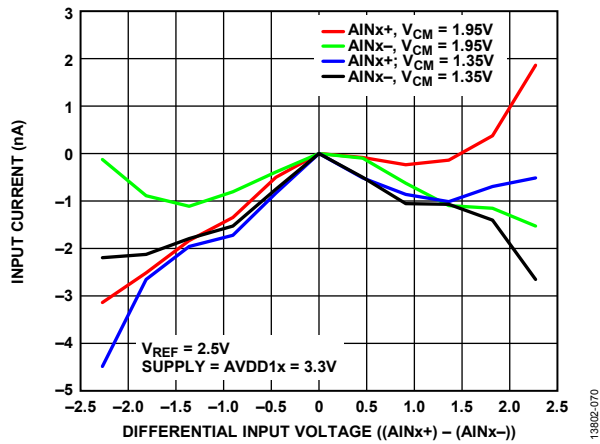

Figure 70. Input Current vs. Differential Input Voltage, High Resolution Mode

13802-070

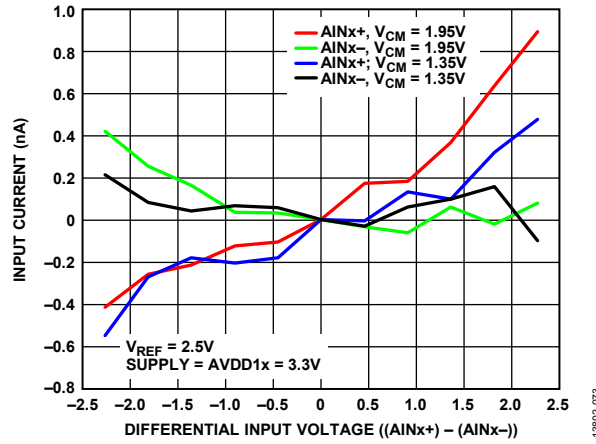

Figure 73. Input Current vs. Differential Input Voltage, Low Power Mode

13802-073

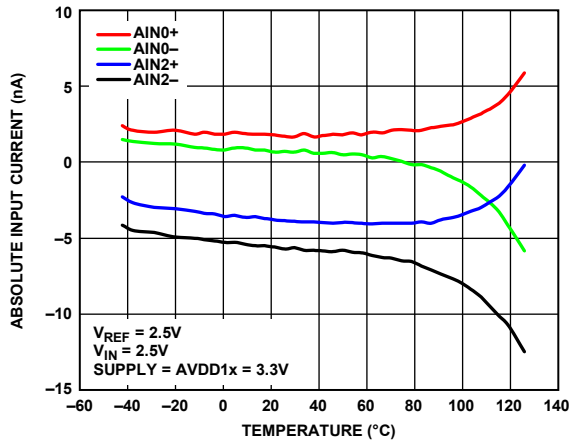

Figure 74. Absolute Input Current vs. Temperature, High Resolution Mode

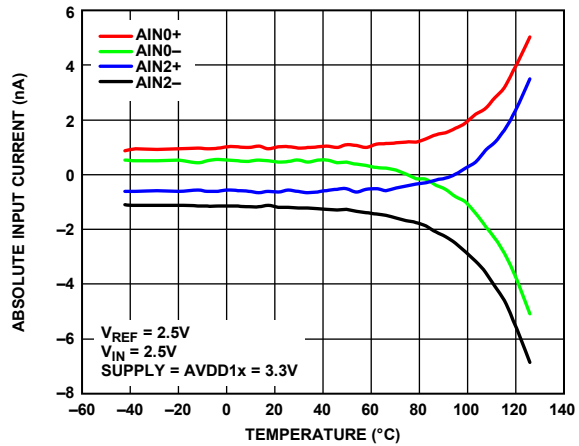

Figure 77. Absolute Input Current vs. Temperature, Low Power Mode

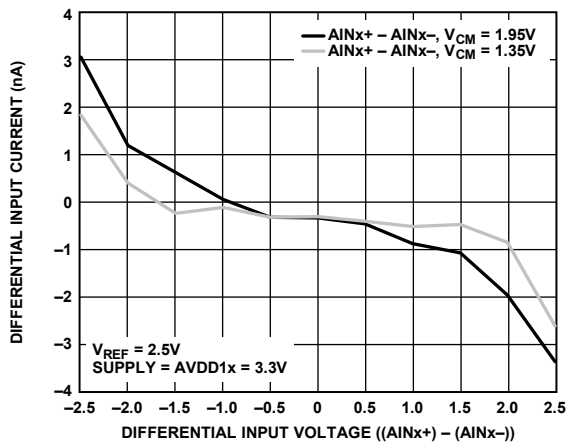

Figure 75. Differential Input Current vs. Differential Input Voltage, High Resolution Mode

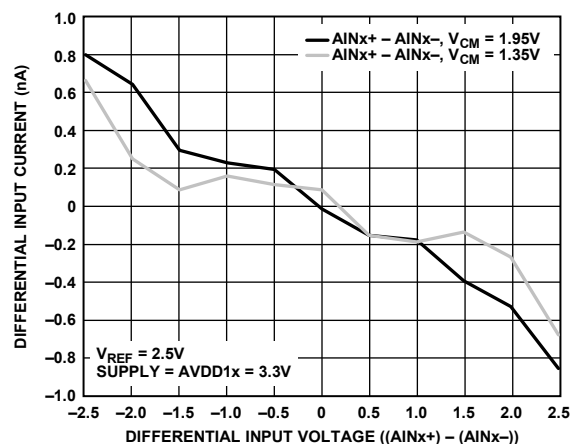

Figure 78. Differential Input Current vs. Differential Input Voltage, Low Power Mode

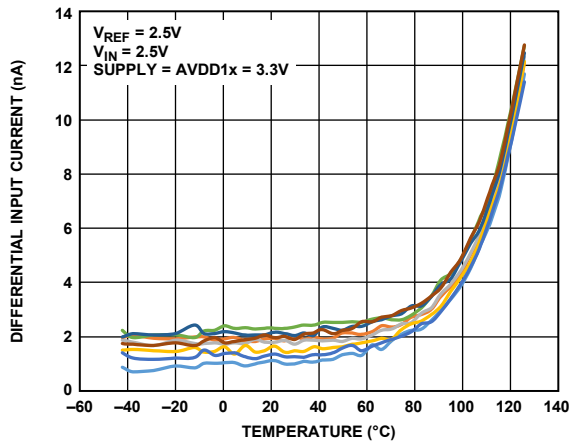

Figure 76. Differential Input Current vs. Temperature, High Resolution Mode

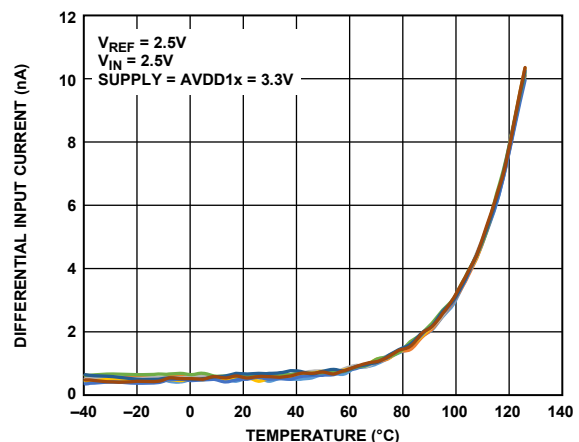

Figure 79. Differential Input Current vs. Temperature, Low Power Mode

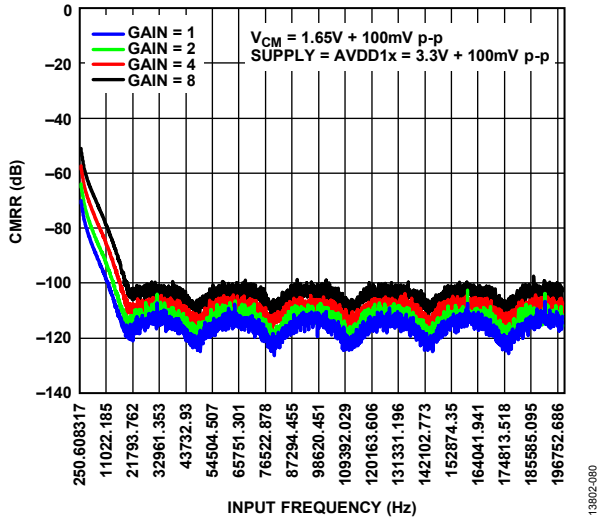

Figure 80. CMRR vs. Input Frequency at 128 kSPS, High Resolution Mode

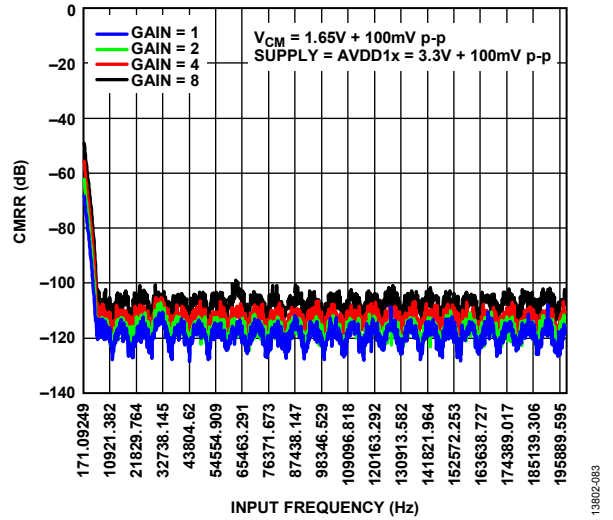

Figure 83. CMRR vs. Input Frequency at 32 kSPS, Low Power Mode

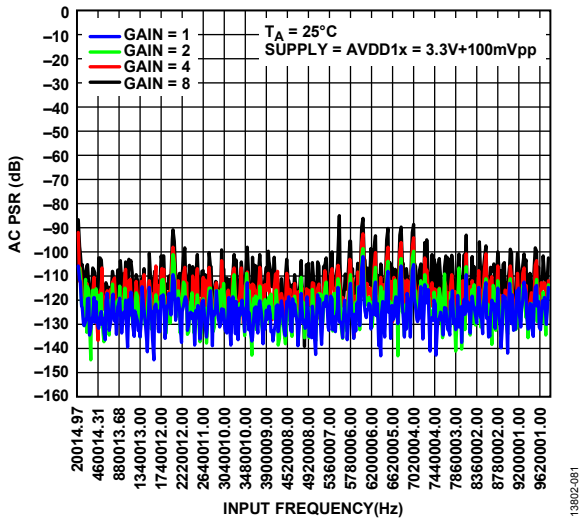

Figure 81. AC PSRR vs. Input Frequency at 128 kSPS, High Resolution Mode

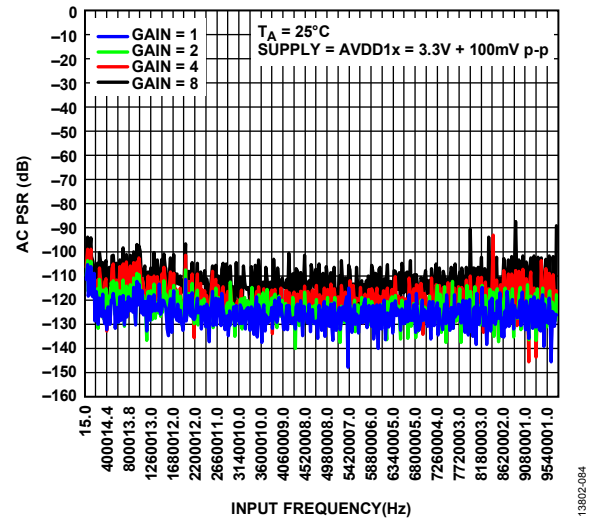

Figure 84. AC PSRR vs. Input Frequency at 32 kSPS, Low Power Mode

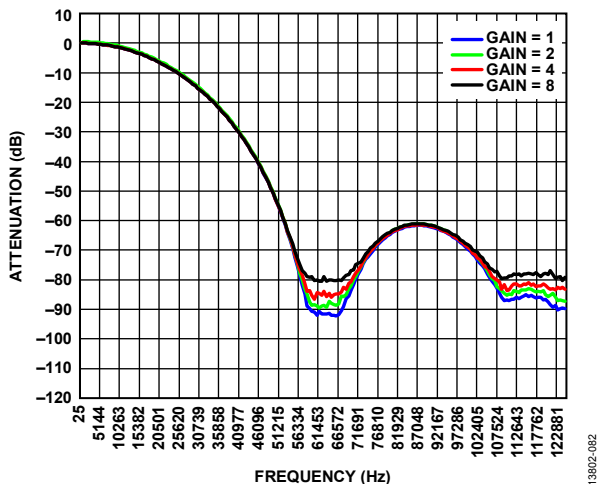

Figure 82. Filter Profiles at 64 kSPS, High Resolution Mode

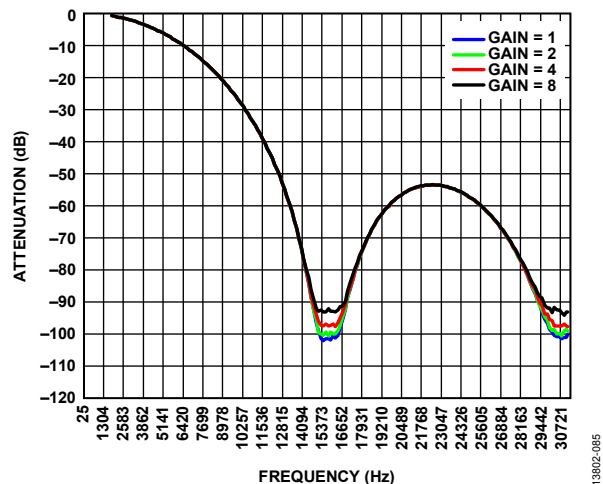

Figure 85. Filter Profiles at 16 kSPS, Low Power Mode

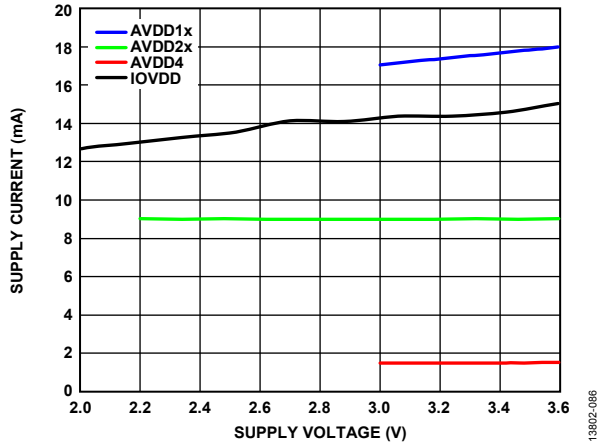

Figure 86. Supply Current vs. Supply Voltage, High Resolution Mode

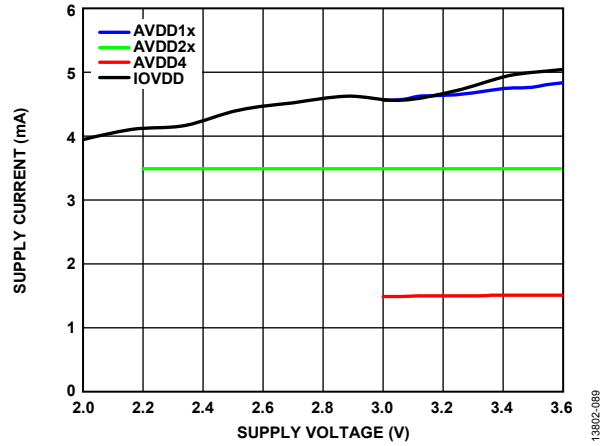

Figure 89. Supply Current vs. Supply Voltage, Low Power Mode

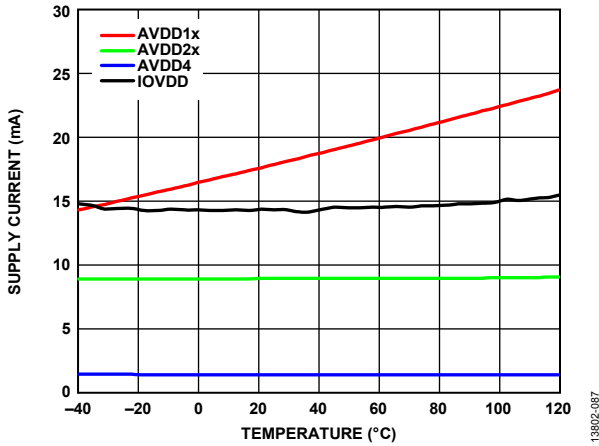

Figure 87. Supply Current vs. Temperature High Resolution Mode

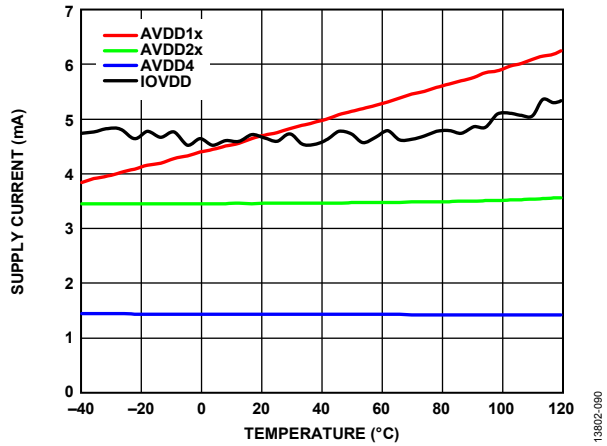

Figure 90. Supply Current vs. Temperature Low Power Mode

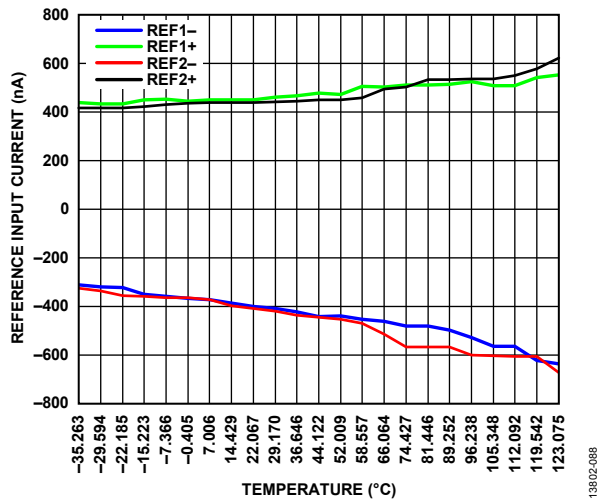

Figure 88. Reference Input Current vs. Temperature, High Resolution Mode

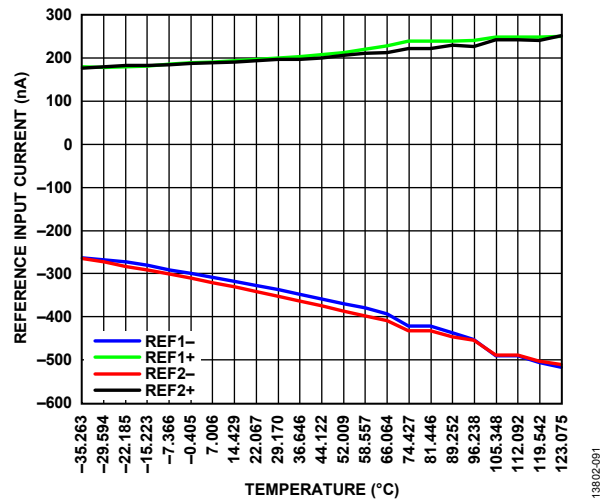

Figure 91. Reference Input Current vs. Temperature, Low Power Mode

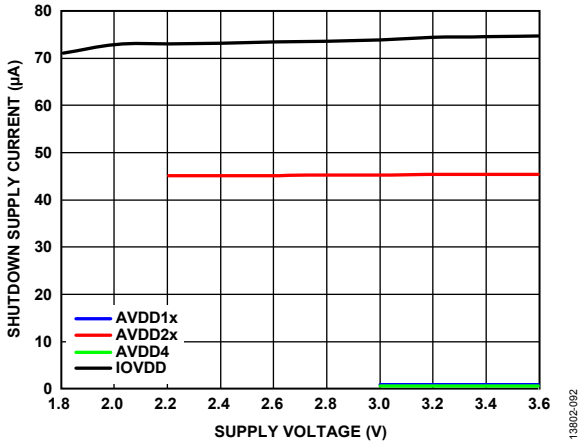

Figure 92. Shutdown Supply Current vs. Supply Voltage

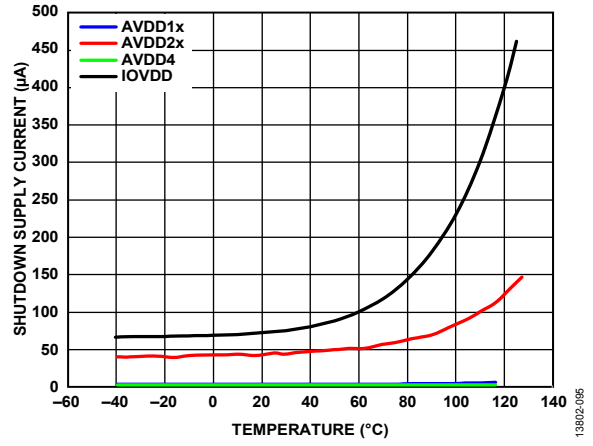

Figure 95. Shutdown Supply Current vs. Temperature

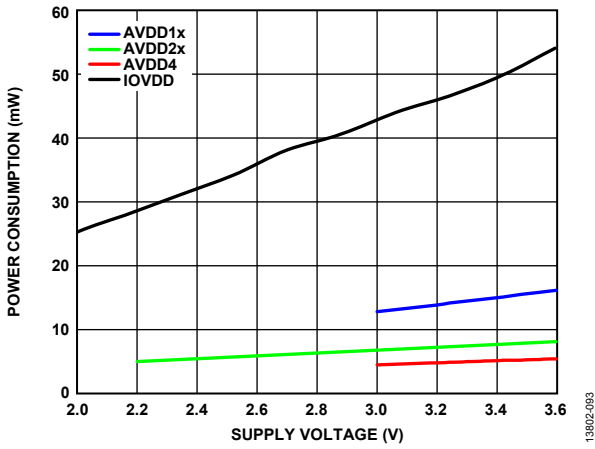

Figure 93. Power Consumption per Channel vs. Supply Voltage, High Resolution Mode

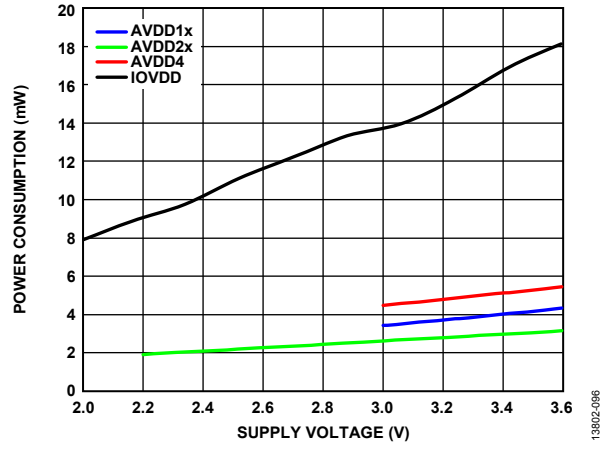

Figure 96. Power Consumption per Channel vs. Supply Voltage, Low Power Mode

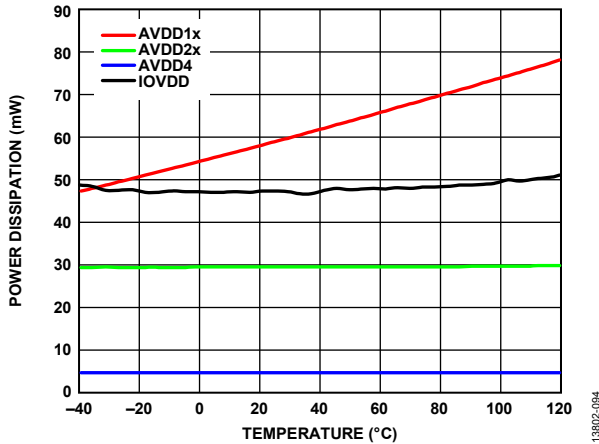

Figure 94. Power Dissipation vs. Temperature, High Resolution Mode

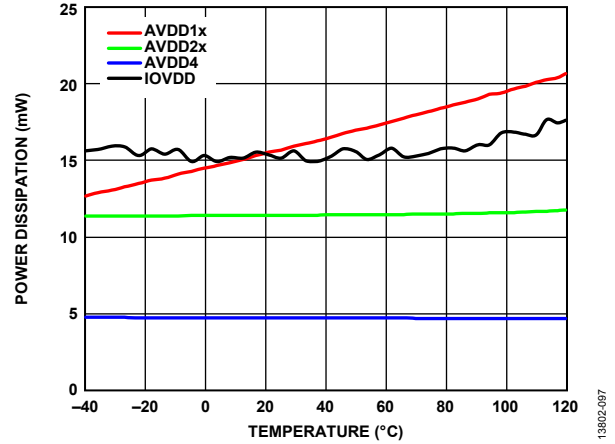

Figure 97. Power Dissipation vs. Temperature, Low Power Mode

TERMINOLOGY

Common-Mode Rejection Ratio (CMRR)

CMRR is the ratio of the power in the ADC output at full-scale frequency, f , to the power of a 100 mV p-p sine wave applied to the common-mode voltage of AINx+ and AINx- at frequency, f_s .

$$CMRR \text{ (dB)} = 10 \log(P_f/P_{f_s})$$

where:

P_f is the power at frequency, f , in the ADC output.

P_{f_s} is the power at frequency, f_s , in the ADC output.

Differential Nonlinearity (DNL) Error

In an ideal ADC, code transitions are 1 LSB apart. Differential nonlinearity is the maximum deviation from this ideal value. DNL error is often specified in terms of resolution for which no missing codes are guaranteed.

Integral Nonlinearity (INL) Error

Integral nonlinearity error refers to the deviation of each individual code from a line drawn from negative full scale through positive full scale. The point used as negative full scale occurs ½ LSB before the first code transition. Positive full scale is a level 1½ LSB beyond the last code transition. The deviation is measured from the middle of each code to the true straight line.

Dynamic Range

Dynamic range is the ratio of the rms value of the full-scale input signal to the rms noise measured for an input. The value for dynamic range is expressed in decibels.

Channel to Channel Isolation

Channel to channel isolation is a measure of the level of crosstalk between channels. It is measured by applying a full-scale frequency sweep sine wave signal to all seven unselected input channels and determining how much that signal is attenuated in the selected channel. The value is given for worst case scenarios across all eight channels of the AD7771.

Intermodulation Distortion

With inputs consisting of sine waves at two frequencies, f_A and f_B , any active device with nonlinearities creates distortion products at the sum and difference frequencies of mf_A and nf_B , where $m, n = 0, 1, 2, 3$, and so on. Intermodulation distortion terms are those for which neither m nor n are equal to 0. For example, the second-order terms include $(f_A + f_B)$ and $(f_A - f_B)$ and the third-order terms include $(2f_A + f_B)$, $(2f_A - f_B)$, $(f_A + 2f_B)$, and $(f_A - 2f_B)$. The AD7771 is tested using the CCIF standard, where two input frequencies near the top end of the input bandwidth are used. In this case, the second-order terms are usually distanced in frequency from the original sine waves, and the third-order terms are usually at a frequency close to the input frequencies. As a result, the second-order and third-order terms are specified separately. The calculation of the intermodulation distortion is per the THD specification, where it is the ratio of the rms sum of the individual distortion products to the rms amplitude of the sum of the fundamentals, expressed in decibels.

Gain Error

The first transition (from 100 ... 000 to 100 ... 001) occurs at a level ½ LSB above nominal negative full scale (-2.49999 V for the ± 2.5 V range). The last transition (from 011 ... 110 to 011 ... 111) occurs for an analog voltage 1½ LSB below the nominal full scale (2.49999 V for the ± 2.5 V range). The gain error is the deviation of the difference between the actual level of the last transition and the actual level of the first transition from the difference between the ideal levels.

Gain Error Drift

Gain error drift is the ratio of the gain error change due to a temperature change of 1°C and the full-scale range (2^N). It is expressed in ppm/°C.

Least Significant Bit (LSB)

The least significant bit, or LSB, is the smallest increment that can be represented by a converter. For a fully differential input ADC with N bits of resolution, the LSB expressed in volts is

$$LSB \text{ (V)} = \frac{2 \times V_{REF}}{2^N}$$

The LSB referred to the input is

$$LSB \text{ (V}_{IN}) = \frac{2 \times V_{REF}}{2^N} \frac{PGA_{GAIN}}{2^N}$$

Power Supply Rejection Ratio (PSRR)

Variations in power supply affect the full-scale transition but not the linearity of the converter. PSRR is the maximum change in the full-scale transition point due to a change in the power supply voltage from the nominal value.

Signal-to-Noise Ratio (SNR)

SNR is the ratio of the rms value of the actual input signal to the rms sum of all other spectral components below the Nyquist frequency, excluding harmonics and dc. The value for SNR is expressed in decibels.

Signal-to-(Noise + Distortion) Ratio (SINAD)

SINAD is the ratio of the rms value of the actual input signal to the rms sum of all other spectral components below the Nyquist frequency, including harmonics but excluding dc. The value for SINAD is expressed in decibels.

Spurious-Free Dynamic Range (SFDR)

SFDR is the difference, in decibels, between the rms amplitude of the input signal and the peak spurious signal including harmonics.

Total Harmonic Distortion (THD)

THD is the ratio of the rms sum of the first five harmonic components to the rms value of a full-scale input signal and is expressed in decibels.

Offset Error

Offset error is the difference between the ideal midscale input voltage (0 V) and the actual voltage producing the midscale output code.

Offset Error Drift

Offset error drift is the ratio of the offset error change due to a temperature change of 1°C and the full-scale code range (2^N). It is expressed in $\mu\text{V}/^\circ\text{C}$.

THEORY OF OPERATION

The AD7771 is an 8-channel, simultaneously sampling, low noise, 24-bit Σ - Δ ADC with integrated digital filtering per channel and SRC.

The AD7771 offers two operation modes: high resolution mode, which offers up to 128 kSPS, and low power mode, which offers up to 32 kSPS.

The AD7771 employs a Σ - Δ conversion technique to convert the analog input signal into an equivalent digital word. The overview of the Σ - Δ technique is that the modulator samples the input waveform and outputs an equivalent digital word at the input clock frequency, f_{CLKIN} .

Due to the high oversampling rate, this technique spreads the quantization noise from 0 Hz to $f_{CLKIN}/2$ (in the case of the AD7771, f_{CLKIN} relates to the external clock); therefore, the noise energy contained in the band of interest is reduced (see Figure 98). To further reduce the quantization noise, a high order modulator is employed to shape the noise spectrum so that most of the noise energy is shifted out of the band of interest (see Figure 99). The digital filter that follows the modulator removes the large out of band quantization noise (see Figure 100).

For more information on basic and advanced concepts of Σ - Δ ADCs, see the [MT-022 Tutorial](#) and [MT-023 Tutorial](#).

Digital filtering has certain advantages over analog filtering. Because digital filtering occurs after the analog-to-digital conversion process, it can remove noise injected during the conversion. Analog filtering cannot remove noise injected during conversion.

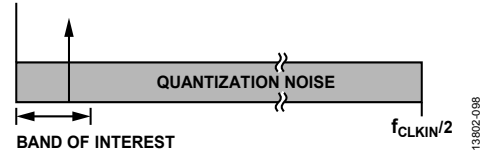

Figure 98. Σ - Δ ADC Operation, Reduction of Noise Energy Contained in the Band of Interest (Linear Scale X-Axis)

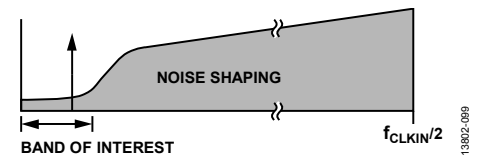

Figure 99. Σ - Δ ADC Operation, Majority of Noise Energy Shifted Out of the Band of Interest (Linear Scale X-Axis)

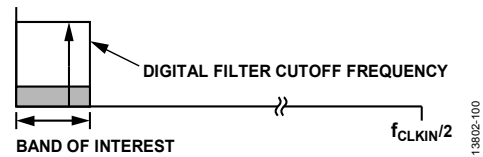

Figure 100. Σ - Δ ADC Operation, Removal of Noise Energy from the Band of Interest (Linear Scale X-Axis)

The Σ - Δ ADC starts the conversions of the input signal after the supplies generated by the internal LDO regulators become stable. An external signal is not required to generate the conversions.

ANALOG INPUTS

The AD7771 can be operated in bipolar or unipolar modes and accepts true differential, pseudo differential, and single-ended input signals, as shown in Figure 101 through Figure 104.

Table 10 summarizes the maximum differential input signal and dynamic range for the different input modes.

Table 10. Input Signal Modes

Input Signal Mode	PGA Gain	Maximum Differential Signal	Maximum Peak-to-Peak Signal
True differential	All gains	$\pm(V_{REF}/PGA_{GAIN})$	$2 \times V_{REF}/PGA_{GAIN}$
Pseudo differential	All gains	$\pm(V_{REF}/PGA_{GAIN})$	$2 \times V_{REF}/PGA_{GAIN}$
Single-ended	All gains	V_{REF}/PGA_{GAIN}	V_{REF}/PGA_{GAIN}

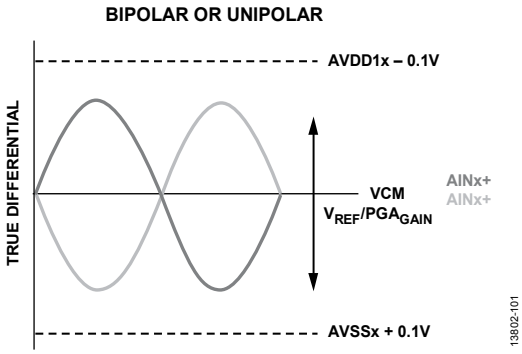

Figure 101. Σ-Δ ADC Input Signal Configuration, True Differential

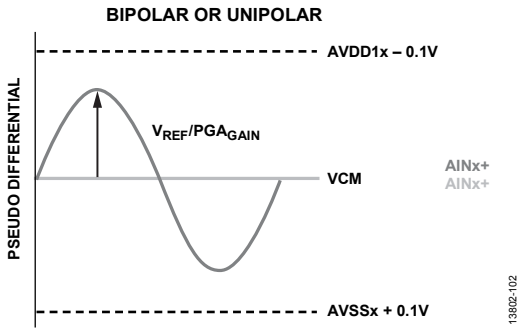

Figure 102. Σ-Δ ADC Input Signal Configuration, Pseudo Differential

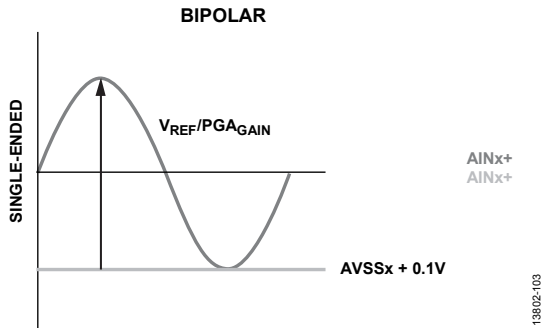

Figure 103. Σ-Δ ADC Input Signal Configuration, Single-Ended Bipolar

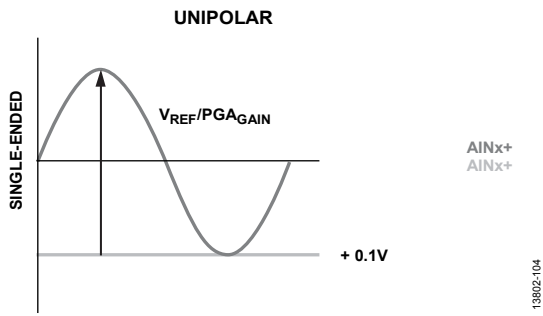

Figure 104. Σ-Δ ADC Input Signal Configuration, Single-Ended Unipolar

The common mode input signal is not limited, but keep the absolute input signal voltage on any AINx± pin between AVSSx + 100 mV and AVDD1x - 100 mV; otherwise, the input signal linearity degrades and, if the signal voltage exceeds the absolute maximum signal rating, damages the device.

Figure 105 shows the maximum and minimum voltage common-mode range at different PGA gains for a maximum differential input voltage.

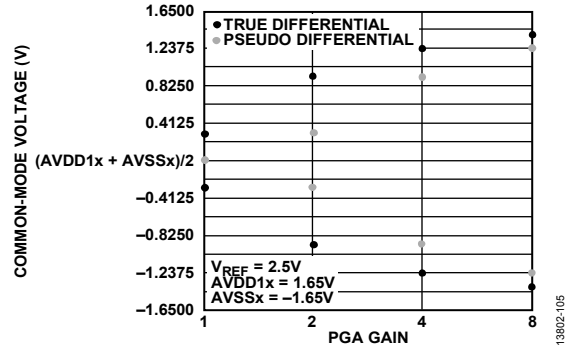

Figure 105. Maximum Common-Mode Voltage Range for a Maximum Differential Input Signal

The AD7771 provides a common-mode voltage pin (AVDD1x + AVSSx)/2, VCM, for the single-supply, pseudo differential, or true differential input configurations.

TRANSFER FUNCTION

The AD7771 can operate with up to a 3.6 V reference, typical at 2.5 V, and converts the differential voltage between the analog inputs (AINx+ and AINx-) into a digital output. The ADC converts the voltage difference between the analog input pins (AINx+ - AINx-) into a digital code on the output. The 24-bit conversion result is in MSB first, twos complement format, as shown in Table 11 and Figure 106.

Table 11. Output Codes and Ideal Input Voltages for PGA = 1x

Condition	Analog Input ((AINx+) - (AINx-)), VREF = 2.5 V	Digital Output Code, Twos Complement (Hexadecimal)
FS - 1 LSB	+2.499999702 V	0x7FFFFF
Midscale + 1 LSB	+298 nV	0x000001
Midscale	0 V	0x000000
Midscale - 1 LSB	-298 nV	0xFFFFF
-FS + 1 LSB	-2.499999702 V	0x800001
-FS	-2.5 V	0x800000

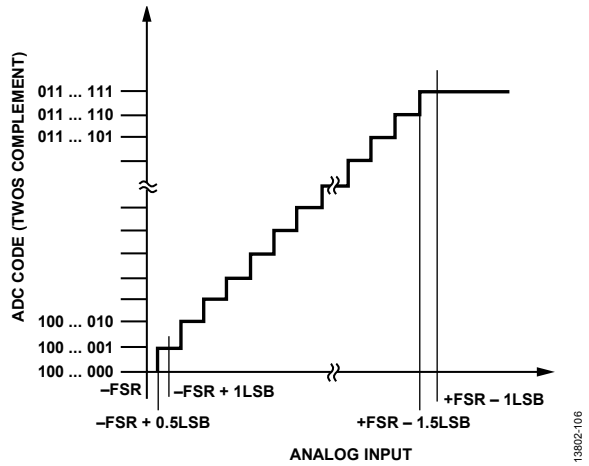

Figure 106. Transfer Function

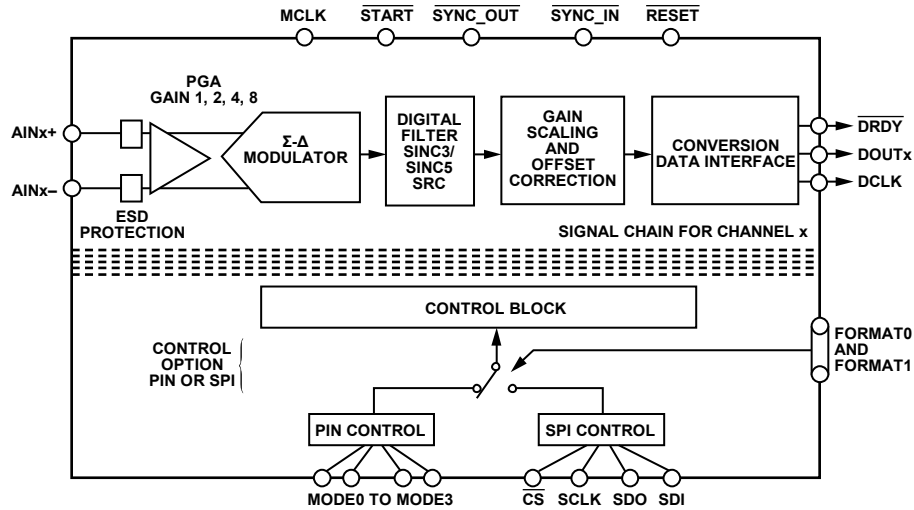

Figure 107. Top Level Core Signal Chain

CORE SIGNAL CHAIN

Each Σ - Δ ADC channel on the AD7771 has an identical signal path from the analog input pins to the digital output pins. Figure 107 shows a top level implementation of this signal chain. Prior to each Σ - Δ ADC, a PGA maps sensor outputs into the ADC inputs, providing low input current in dc (± 8 nA, input current, and ± 2 nA differential input current for high resolution mode), an 8 pF input capacitance in ac, and configurable gains of 1, 2, 4, and 8. See the [AN-1392 Application Note](#) for more information. Each ADC channel has its own Σ - Δ modulator, which oversamples the analog input and passes the digital representation to the digital filter block. The data is filtered, scaled for gain and offset, and is then output on the data interface.

To minimize power consumption, the channels can be individually disabled.

CAPACITIVE PGA

Each Σ - Δ ADC has a dedicated PGA, offering gain ranges of 1, 2, 4, and 8. This PGA reduces the need for an external input buffer and allows the user to amplify small sensor signals to use the full dynamic range of the AD7771.

The PGA maximizes the signal chain dynamic range for small sensor output signals.

The AD7771 uses chopping of the PGA to minimize offset and offset drift in the input amplifier, reducing the $1/f$ noise as well. For the AD7771, the chopping frequency is set to 128 kHz for high resolution mode, and 32 kHz for low power mode (see the [AN-1392 Application Note](#) for more information). The chopping tone is rejected by the sinc3 or sinc5 filters.

To minimize intermodulation effects that may cause an image in the band of interest, it is recommended to limit the input signal bandwidth to $2/3$ of the chop frequency.

The capacitive PGA common-mode voltage does not depend on the gain, and can be any value as long as the input signal voltage is within $AVSSx + 100$ mV to $AVDD1x - 100$ mV. See Figure 105

for the maximum common-mode voltage at maximum differential input signals.

INTERNAL REFERENCE AND REFERENCE BUFFERS

The AD7771 integrates a 2.5 V, ± 10 ppm/ $^{\circ}\text{C}$ (typical), voltage reference that is disabled at power-up. The buffered reference is available at Pin 49 and offers up to 10 mA of continuous current. A 100 nF capacitor is required if the reference is enabled.

In applications where a low noise reference is required, it is recommended to add a low-pass filter (LPF) with a cutoff frequency (f_{CUTOFF}) below 10 Hz to the REF_OUT pin. Connect the output of this filter to REFx+, and connect AVSSx to REFx-. In this scenario, configure the Σ - Δ reference as external. An example of performance with and without the output filter is shown in Figure 108.

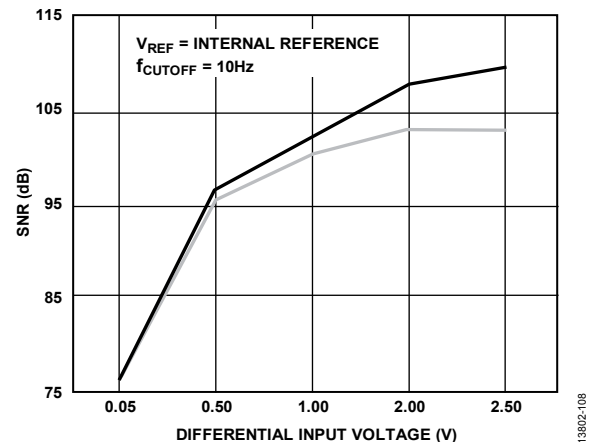
Figure 108. SNR Adding External LPF with $V_{\text{REF}} = \text{Internal Reference}$ and $f_{\text{CUTOFF}} = 10$ Hz

The AD7771 can be used with an external reference connected between the REFx+ and REFx- pins. Recommended reference voltage sources for the AD7771 include the [ADR441](#) and [ADR4525](#) family of low noise, high accuracy voltage references.

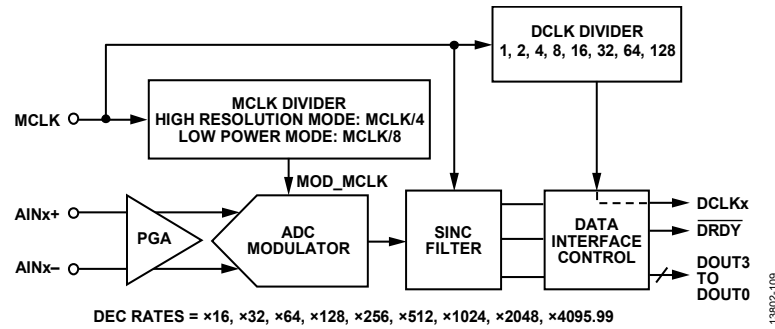

Figure 109. Clock Generation on the AD7771

The reference buffers can be operated in three different modes: buffer enabled mode, buffer bypassed mode, and buffer precharged mode.

In buffer enabled mode, the buffer is fully enabled, minimizing the current requirements from the external references. Note that the buffer output voltage headroom is ± 100 mV from the rails.

In buffer bypassed mode, the external reference is directly connected to the ADC reference capacitors; the reference must provide enough current to correctly charge the internal ADC reference capacitors. In this mode of operation, a degradation in crosstalk is expected because the ADC channels are not isolated from each other.

Buffer precharged (pre-Q) mode is the default operation mode. It is a hybrid mode where the internal reference buffers are connected during the initial acquisition time to precharge the internal ADC reference capacitors. During the final phase of the acquisition, the reference is connected directly to the ADC capacitors. This mode has some benefits compared to the buffer enabled and buffer bypassed modes. In buffer pre-Q mode, the reference current requirements are minimized compared to buffer bypassed mode and the noise contribution from the internal reference buffers is removed (compared to buffer enabled mode).

In buffer pre-Q mode, the headroom/footroom of the buffer reference is not applicable because the reference sets the final voltage in the ADC reference capacitors.

INTEGRATED LDOs

The AD7771 has three internal LDOs to regulate the internal supplies: two LDOs for the analog block and one LDO for the digital core. The internal LDOs requires an external $1 \mu\text{F}$ decoupling capacitor on the DREGCAP, AREG1CAP, and the AREG2CAP pins. The LDO slew rate may be low because it depends on the main supply slew rate; therefore, a hardware reset generated by pulsing the $\overline{\text{RESET}}$ pin at power-up is required to guarantee that the digital block initializes correctly.

CLOCKING AND SAMPLING

The AD7771 includes eight Σ - Δ ADC cores. Each ADC receives the same master clock signal. The AD7771 requires a maximum external MCLK frequency of 8192 kHz for high resolution mode and 4096 kHz for low power mode. The MCLK is internally divided by 4 in high performance mode and by 8 in low power mode to produce the modulator MCLK (MOD_MCLK) signal used as the modulator sampling clock for the ADCs. The MCLK can be decreased to accommodate lower ODRs if the minimum ODR selected by the sinc3 filter is not low enough. If the external clock is lower than 250 kHz, set the CLK_QUAL_DIS bit (in SPI control mode only).

The AD7771 integrates an internal oscillator clock that initializes the internal registers at power-up. The CLK_SEL pin defines the external clock used after initialization (see Table 12).

Table 12. Clock Sources

CLK_SEL State	Clock Source	Connection
0	CMOS	Input to XTAL2/MCLK, IOVDD logic level. XTAL1 must be tied to DGND.
1	Crystal	Connected between XTAL1 and XTAL2/MCLK.

The MCLK signal generates the DCLK output signal, which in turn clocks the Σ - Δ conversion data from the AD7771, as shown in Figure 109.

DIGITAL RESET AND SYNCHRONIZATION PINS

An external pulse in the SYNC_IN pin generates the internal reset of the digital block; this pulse does not affect the data programmed in the internal registers. A pulse in this pin is required in two cases as follows:

- After updating one or more registers directly related to the sinc filter (power mode, offset, gain, phase compensation, and sinc filter).
- To synchronize multiple devices.

The pulse in the $\overline{\text{SYNC_IN}}$ pin must be synchronous with MCLK.

There are two different ways to achieve a synchronous pulse if the controller/processor cannot generate it as follows:

- Applying an asynchronous pulse on the $\overline{\text{START}}$ pin, which is then internally synchronized with the external MCLK clock, and the resulting synchronous signal is output on the $\overline{\text{SYNC_OUT}}$ pin.
- Triggering the $\overline{\text{SYNC_OUT}}$ internally. When the AD7771 is configured in SPI control mode, toggling Bit 0 in the GENERAL_USER_CONFIG_2 register generates a synchronous pulse that is output on the $\overline{\text{SYNC_OUT}}$ pin.

The $\overline{\text{SYNC_IN}}$ and $\overline{\text{SYNC_OUT}}$ pins must be externally connected if internal synchronization is used.

If multiple AD7771 devices must be synchronized, the $\overline{\text{SYNC_OUT}}$ pin of one device can be connected to multiple devices. This synchronization method requires the use of a common MCLK signal for all the AD7771 devices connected, as shown in Figure 110.

If the $\overline{\text{START}}$ pin is not used, tie it to DGND.

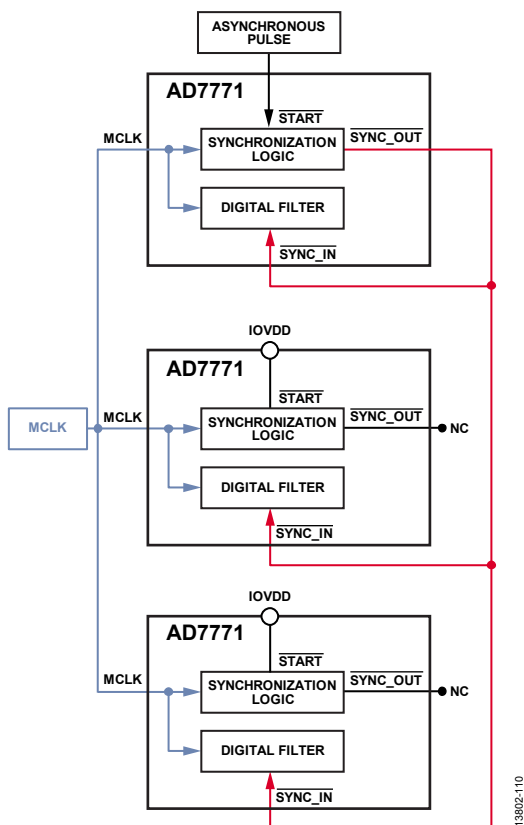

Figure 110. Multiple AD7771 Devices Synchronization

DIGITAL FILTERING

The AD7771 offers low latency sinc3 and sinc5 filters. Most precision Σ - Δ ADCs use sinc filters because the sinc filters offer a low latency path for applications requiring low bandwidth signals, for example, in control loops or where application specific postprocessing is required. The digital filter adds notches at multiples of the sampling frequency.

The digital sinc3 filter implements three main notches, one at the maximum ODR (128 kHz or 32 kHz, depending on the power mode) and another two at the ODR frequency selected to stop noise aliasing into the pass band. The sinc5 filter implements five notches, one at the maximum ODR (128 kHz or 32 kHz, depending on the power mode) and another four at the ODR frequency selected to stop noise aliasing into the pass band. It is recommended to select the sinc5 digital filter for output data rates higher than 24 kSPS.

Figure 111 and Figure 112 show the typical filter transfer function for the high resolution and low power modes using a decimation rate of 32 samples for the sinc3 and sinc5 filters.

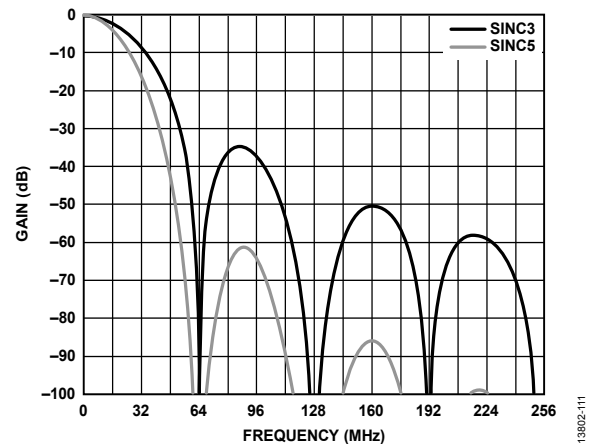

Figure 111. Sinc3/Sinc5 Frequency Response in High Resolution Mode

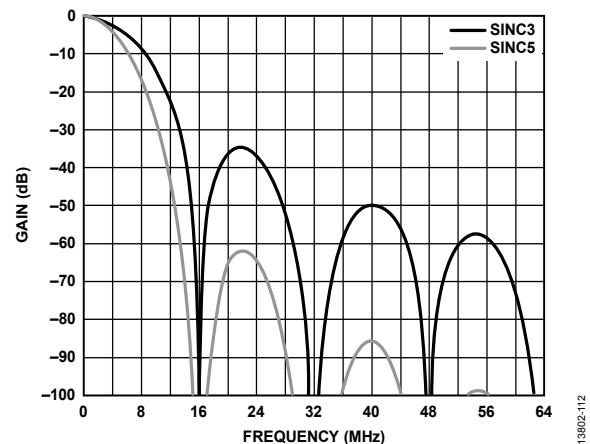

Figure 112. Sinc3/Sinc5 Frequency Response in Low Power Mode

The sample rate converter feature allows fine tuning of the decimation rate, even for noninteger multiples of the decimation rate. See the Sample Rate Converter (SRC) section for more information on filter profiles for noninteger decimation rates.

SHUTDOWN MODE

The AD7771 can be placed in shutdown mode by pulling AVDD2x to ground and connecting 1 M Ω resistance, pulled low, to XTAL2/MCLK. In this mode, the average current consumption is reduced to 1 mA, as shown in Figure 113.

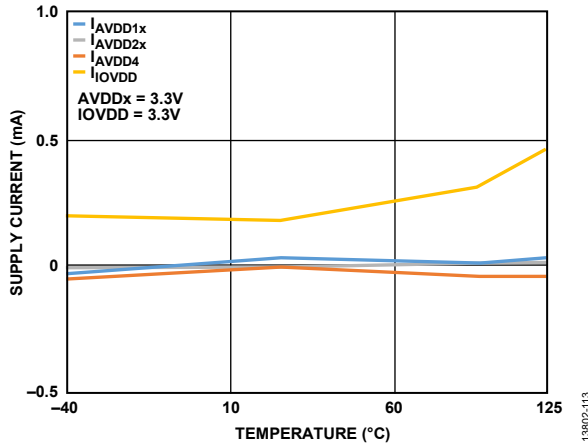

Figure 113. Shutdown Current

CONTROLLING THE AD7771

The AD7771 can be controlled using either pin control mode or SPI control mode.

Pin control mode allows the AD7771 to be hardwired to predefined settings that offer a subset of the overall functionality of the AD7771. In this mode, the SRC and diagnostic features or extended errors source are not available.

Controlling the AD7771 over the SPI allows the user access to the full monitoring, diagnostic, and Σ - Δ control functionality. SPI control offers additional functionality such as offset, gain, and phase correction per channel, in addition to access to the flexible SRC to achieve a coherent sampling.

See Table 13 for more details about these different configurations.

PIN CONTROL MODE

In pin control mode, the AD7771 is configured at power-up based on the level of the mode pins, MODE0, MODE1, MODE2, and MODE3. These four pins set the following functions on the AD7771: the mode of operation, the decimation rate/ODR, the PGA gain, and the reference source, as shown in Table 14.

Due to the limited number of mode pins and the number of options available, the PGA gain control is grouped into blocks of 4, and the ODR is selected for the maximum value defined by the decimation rate; $ODR \text{ (kHz)} = 2048/\text{decimation}$ for high resolution mode, and $ODR \text{ (kHz)} = 512/\text{decimation}$ for low power mode.

Depending on the mode selected, the device is configured to use an external or an internal reference.

The conversion data can be read back using the SPI or the data output interface, as shown in Table 13. If the data output interface is used to read back the data from the conversions, the number of DOUTx lines enabled and the number of clocks required for the Σ - Δ data transfer are determined by the logic level of the CONVST_SAR, FORMAT0, and FORMAT1 pins. In this case, the DCLK2, DCLK1, and DCLK0 pins select the Σ - Δ output interface and control the DCLKx divide function, which is a submultiple of MCLK, as shown in Table 15. The DCLKx divide function sets the frequency of the data output interface DCLKx signal. The DCLK minimum frequency depends on the decimation rate and operation mode. See the Data Output Interface section for more details about the minimum DCLKx frequency.

All the pins that define the AD7771 configuration mode are reevaluated each time the SYNC_IN pin is pulsed. The typical connection diagram for pin control mode is shown in Figure 114.

Table 13. Format of the Data Interface

CONVST_SAR State	FORMAT1	FORMAT0	Control Mode	Data Output Mode
1	0	0	Pin	SPI output
	0	1	Pin	SPI output
	1	0	Pin	SPI output
	1	1	SPI	Defined in Register 0x013 and/or Register 0x014
0	0	0	Pin	DOUT0, Channel 0 and Channel 1 DOUT1, Channel 2 and Channel 3 DOUT2, Channel 4 and Channel 5 DOUT3, Channel 6 and Channel 7
	0	1	Pin	DOUT0, Channel 0 to Channel 3 DOUT1, Channel 4 to Channel 7
	1	0	Pin	DOUT0, Channel 0 to Channel 7
	1	1	SPI	Defined in Register 0x013 and/or Register 0x014

Table 14. Pin Control Mode Options

Pin State				Decimation Rate	Power Mode	PGA Gain Channel		Reference Source	Filter
MODE3	MODE2	MODE1	MODE0			Channel 0 to Channel 3	Channel 4 to Channel 7		
0	0	0	0	16	High resolution	1	1	External	Sinc5
0	0	0	1	16	High resolution	1	4	External	Sinc5
0	0	1	0	32	High resolution	1	1	External	Sinc5
0	0	1	1	32	High resolution	1	4	External	Sinc5
0	1	0	0	64	High resolution	1	1	External	Sinc5
0	1	0	1	64	High resolution	1	4	External	Sinc5
0	1	1	0	128	High resolution	1	1	External	Sinc5
0	1	1	1	128	High resolution	1	4	External	Sinc5
1	0	0	0	256	High resolution	1	1	External	Sinc5
1	0	0	1	16	High resolution	1	1	Internal	Sinc5
1	0	1	0	32	High resolution	1	1	Internal	Sinc5
1	0	1	1	64	High resolution	1	1	Internal	Sinc5
1	1	0	0	16	Low power	1	1	External	Sinc5
1	1	0	1	32	Low power	1	1	External	Sinc5
1	1	1	0	64	Low power	1	1	External	Sinc3
1	1	1	1	32	Low power	1	1	External	Sinc3

Table 15. DCLKx Selection for Pin Control Mode State

DCLK2/SCLK	DCLK1/SDI	DCLK0/SDO	MCLK Divider
0	0	0	1
0	0	1	2
0	1	0	4
0	1	1	8
1	0	0	16
1	0	1	32
1	1	0	64
1	1	1	128

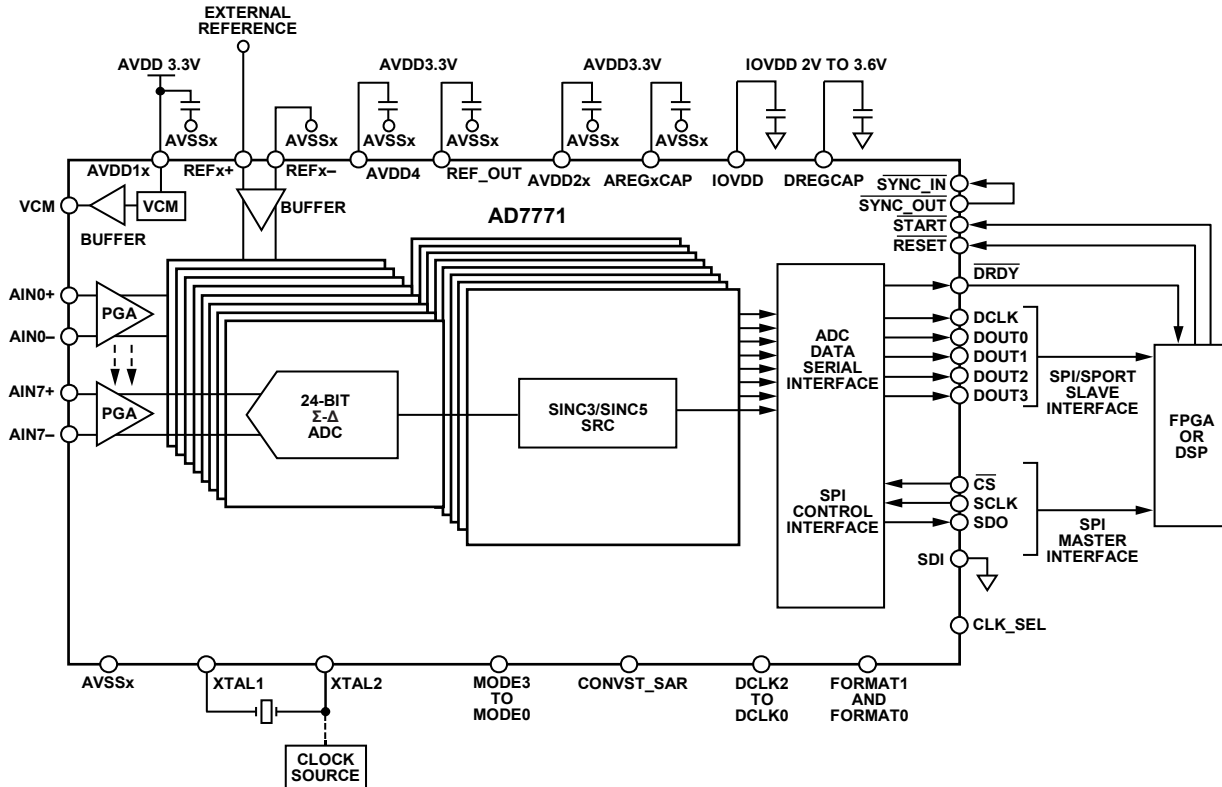

Figure 114. Pin Control Mode Connection Diagram with External Reference

13802-114

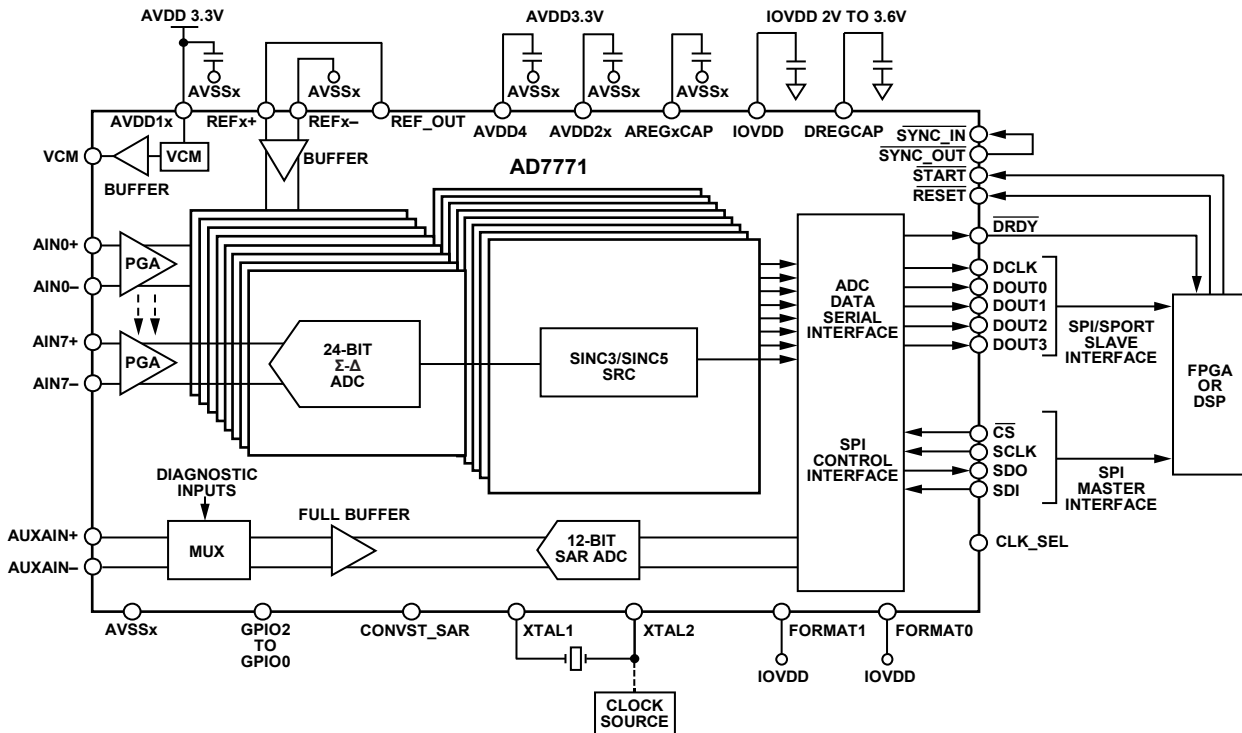

Figure 115. SPI Control Mode Connection Diagram with Internal Reference

13802-115

SPI CONTROL

The second option for control and monitoring the AD7771 is via the SPI. This option allows access to the full functionality on the AD7771, including access to the SAR converter, phase synchronization, offset and gain adjustment, diagnostics, and the SRC. To use the SPI control, set the FORMAT0 and FORMAT1 pins to logic high.

In this mode, the SPI can also read the Σ - Δ conversation data by setting the SPI_SLAVE_MODE_EN bit.

The typical connection diagram for SPI control mode is shown in Figure 115.

Functionality Available in SPI Control Mode

SPI control of the AD7771 offers the super set of the functions and diagnostics. The SPI Control Functionality section describes the functionality and diagnostics offered when in SPI control mode.

Offset and Gain Correction

Offset and gain registers are available for system calibration. The gain register is preprogrammed during final production for a PGA gain of 1, but can be overwritten with a new value if required.

The gain register is 24 bits long and is split across three registers, CHx_GAIN_UPPER_BYTE, CHx_GAIN_MID_BYTE, and CHx_GAIN_LOWER_BYTE, which set the gain on a per channel basis.

The gain value is relative to 0x555555, which represents a gain of 1.

The offset register is 24 bits long and is spread across three byte registers, CHx_OFFSET_UPPER_BYTE, CHx_OFFSET_MID_BYTE, and CHx_OFFSET_LOWER_BYTE. The default value is 0x000000 at power-up. Program the offset as a twos complement, signed 24-bit number. If the channel gain is set to its nominal value of 0x555555, an LSB of offset register adjustment changes the digital output by $-4/3$ LSBs.

As an example of calibration, the offset measured is -200 LSB (with both AINx \pm pins connected to the same potential).

An offset adjustment of -150 LSB changes the digital output by $-150 \times (-4/3) = 200$ LSBs (gain value = 0x555555), representing this number as two complement, 0xFFFFF - 0x96 + 1 = 0xFFFF70. Program the offset register as follows:

- CHx_OFFSET_UPPER_BYTE = 0xFF
- CHx_OFFSET_MID_BYTE = 0xFF
- CHx_OFFSET_LOWER_BYTE = 0x70

Note that the offset compensation is performed before the gain compensation. The gain is programmed during final testing for $PGA_{GAIN} = 1$. The gain register values can be overwritten; however, after a reset or power cycle, the gain register values revert to the hard coded programmed factory setting.

If the gain required is 0.75 of the nominal value (0x555555), the value that must be programmed is

$$0x555555 \times 0.75 = 0x400000$$

Then, an LSB of the offset register adjustment changes the digital output by $-4/3 \times 0.75 = 1$ LSB. Program the gain register as follows:

- CHx_GAIN_UPPER_BYTE = 0x40
- CHx_GAIN_MID_BYTE = 0x00
- CHx_GAIN_LOWER_BYTE = 0x00

SPI Control Functionality

Global Control Functions

The following list details the global control functions of the AD7771:

- High resolution and low power modes of operation
- ODR: SRC
- Sinc3 and sinc5 filters
- VCM buffer power-down
- Internal/external reference selection
- Enable, pre-Q, or bypassed reference buffer modes
- Internal reference power-down
- SAR diagnostic mux
- SAR power-down
- GPIO write/read
- SPI SAR conversion readback
- SPI slave mode—read Σ - Δ results
- SDO and DOUTx drive strength
- DOUTx mode
- DCLK division
- Internal LDO bypassed
- Cyclic redundancy check (CRC) protection: enabled or disabled

Per Channel Functions

The following list details the per channel functions of the AD7771:

- PGA gain.
- Σ - Δ channel power-down.
- Phase delay: synchronization phase offset per channel.
- Calibration of offset.
- Calibration of gain.
- Σ - Δ input signal mux.
- Channel error register.
- PGA gain.

Phase Adjustment

The AD7771 phase delay can be adjusted to compensate for phase mismatches between channels due to sensors or signal channel phase errors connected to the AD7771. Achieve phase adjustment by programming the CHx_SYNC_OFFSET register. This programming delays the synchronization signal by a certain number of modulator clocks (MOD_MCLK) to individually initiate the digital filter for each Σ - Δ ADC. In other words, programming the channel with higher phase delay as CHx_SYNC_OFFSET=0, any other channel with lower phase, can be delayed to compensate for the phase mismatch.

The phase adjustment register is read after a pulse on the SYNC_IN pin; consequently, any further changes on the register have no effect unless a pulse is generated (see the Digital Reset and Synchronization Pins section for more information on how to generate a pulse in the pin).

The phase offset register is multiplied internally by a factor (n) that depends on the decimation rate, as shown in Table 16.

Table 16. Phase Adjustment vs. Decimation Rate

Phase Adjustment Compensation (n)	Decimation Rate
×1	≤255
×2	≤511
×4	≤1023
×8	≤2047
×16	≤4095

The maximum phase delay cannot be equal to or greater than the decimation rate. If this is the case, the value changes internally to the decimation rate value minus 1.

When the CHx_SYNC_OFFSET register is written, it automatically overwrites itself multiplied by the corresponding factor (n), as defined in Table 16. Because CHx_SYNC_OFFSET is only 8 bits long, the resulting value is scaled down to fit 8 bits. To determine whether phase adjustment was clipped or not, see Table 17.

Table 17. Phase Adjustment Clipping

CHx_SYNC_OFFSET × n	CHx_SYNC_OFFSET Overwrite
≤255	CHx_SYNC_OFFSET × n
≤511	CHx_SYNC_OFFSET × n/2
≤1023	CHx_SYNC_OFFSET × n/4
≤2047	CHx_SYNC_OFFSET × n/8
≤4095	CHx_SYNC_OFFSET × n/16

As an example, the phase mismatch between Channel 0 and Channel 1 is 5°, and the ODR is 5 kSPS in high resolution mode. In this case, the decimation rate is 2048 kHz/5 kHz = 409.6, which means that the offset register value is multiplied internally by 2.

Assuming an input signal of 50 Hz, the number of MOD_MCLK pulses required to sample a full period is 2048 kHz/50 Hz = 40960 > 360°/40960 = 0.00878°.

If a 5° delay is required, the number of MOD_MCLK delays must be 569 (5°/0.00878°) because the offset register is multiplied by 2; the final offset register value is 409.6/2 – 569/2, which gives a negative value. In this case, if the offset value programmed to the register is higher than 204 (for example, 210 × 2 = 420), the value is internally changed to 408, resulting in a phase compensation of 408 × 0.00878° = 3.58°.

PGA Gain

The PGA gain can be selected individually by appropriately selecting Bits[7:6] in the CHx_CONFIG register, as shown in Table 18.

Table 18. PGA Gain Settings via CHx_CONFIG

CHx_CONFIG, Bits[7:6] Setting	PGA Gain Setting
00	×1
01	×2
10	×4
11	×8

If the Σ-Δ reference is updated, it is recommended to apply a pulse on the SYNC_IN pin to remove invalid samples during the transition of the reference.

Decimation

The decimation defines the sampling frequency as follows:

- In high resolution mode, the sampling frequency = MCLK/(4 × decimation)
- In low power mode, the sampling frequency = MCLK/(8 × decimation)

Refer to the Sample Rate Converter (SRC) section for more information.

GPIOx Pins

If the AD7771 operates in SPI control mode, the mode pins operate as GPIOx pins, as shown in Figure 116. The GPIOx pins can be configured as inputs or outputs in any order.

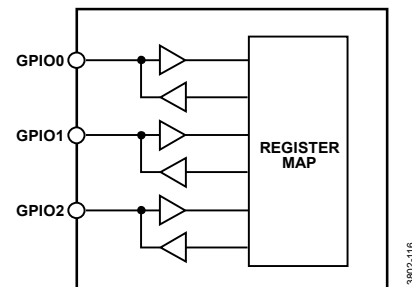

Figure 116. GPIOx Pin Functionality

Configuration control and readback of the GPIOx pins are set via Bits[2:0] in the GPIO_CONFIG register (0 = input, 1 = output) and the GPIO_DATA register. Among other uses, the GPIOs can control an external mux connected to the auxiliary inputs of the SAR ADC. Use this mux to verify the results on the Σ-Δ ADCs.

In addition, the GPIOx pins can be used to externally trigger a new decimation rate. Refer to the Sample Rate Converter (SRC) section for more information about this functionality.

Σ-Δ Reference Configuration

The AD7771 can operate with internal or external references. In addition, for diagnostic purposes, the analog supply can be used as a reference, as shown in Table 19. REF_{x-}/REF_{x+} allow the selection of a voltage reference where the REF_{x+} voltage is lower than the voltage on the REF_{x-} pin.

Table 19. Σ-Δ References

Setting for ADC_MUX_CONFIG, Bits[7:6]	Channel 0 to Channel 3	Channel 4 to Channel 7
00	REF1+/REF1-	REF2+/REF2-
01	Internal reference	Internal reference
10	AVDD1A/AVSS1A	AVDD1B/AVSS1B
11	REF1-/REF1+	REF2-/REF2+

Reference buffer operation is described in Table 21. The selected reference and buffer operation mode affect all channels.

If the Σ-Δ reference is updated, it is recommended to apply a pulse on the SYNC_IN pin to remove invalid samples during the transition of the reference.

Power Modes

The AD7771 offers different power modes to improve the power efficiency, high resolution and low power mode, which can be controlled via GENERAL_USER_CONFIG_1, Bit 6. To further

reduce the power, additional blocks can be disabled independently, as described in Table 22.

If the power mode changes, a pulse on the SYNC_IN pin is required.

Sinc3 and Sinc5 Filters

The AD7771 implements sinc3 and sinc5 digital filters. By default, the device powers up with the sinc3 filter, but it can be changed by setting GENERAL_USER_CONFIG_2, Bit 6. If the sinc filter is changed, a pulse in the SYNC_IN pin is required.

LDO Bypassing

The internal LDOs can be individually bypassed and an external supply can be applied directly to the AREG1CAP, AREG2CAP, or DREGCAP pin. Table 20 shows the absolute minimum and maximum supplies for these pins, as well as the associated register used to bypass the regulator.

Table 20. LDO Bypassing

LDO	BUFFER_CONFIG_2, Bits[2:0] ¹	Supply	
		Max (V)	Min (V)
AREG1CAP	1XX	1.9	1.85
AREG2CAP	X1X	1.9	1.85
DREGCAP	XX1	1.9	1.65

¹ X means don't care.

Table 21. Reference Buffer Operation Modes

Reference Buffer Operation Mode	REF _{x+}	REF _{x-}
Enabled	BUFFER_CONFIG_1, Bit 4 = 1; BUFFER_CONFIG_2, Bit 7 = 0	BUFFER_CONFIG_1, Bit 3 = 1; BUFFER_CONFIG_2, Bit 6 = 0
Precharged	BUFFER_CONFIG_1, Bit 4 = 1; BUFFER_CONFIG_2, Bit 7 = 1	BUFFER_CONFIG_1, Bit 3 = 1; BUFFER_CONFIG_2, Bit 6 = 1
Disabled	BUFFER_CONFIG_1, Bit 4 = 0	BUFFER_CONFIG_1, Bit 3 = 0

Table 22. Additional Disable Power-Down Blocks

Block	Register	Notes
VCM	GENERAL_USER_CONFIG_1, Bit 5	Enabled by default
Reference Buffer	BUFFER_CONFIG_1, Bits[4:3]	Precharge mode by default
Internal Reference Buffer	GENERAL_USER_CONFIG_1, Bit 4	Disabled by default
Σ-Δ Channel	CH_DISABLE, Bits[7:0]	All channels enabled
SAR	GENERAL_USER_CONFIG_1, Bit 3	Disabled by default
Internal Oscillator	GENERAL_USER_CONFIG_1, Bit 2	Enabled by default

DIGITAL SPI

The SPI serial interface on the AD7771 consists of four signals: CS, SDI, SCLK, and SDO. A typical connection diagram of the SPI is shown in Figure 117.

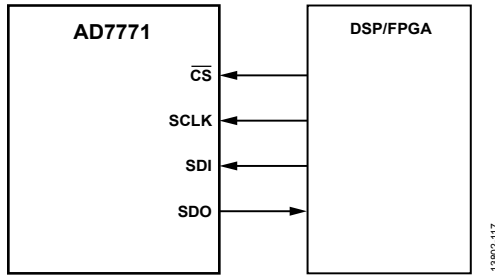

Figure 117. SPI Control Interface—AD7771 is the SPI Slave, Digital Signal Processor (DSP)/Field Programmable Gate Array (FPGA) is the Master

The SPIs operates in Mode 0 and Mode 3, CPOL = 0, CPHA = 0 (Mode 0) or CPOL = 1, CPHA = 1 (Mode 3).

In pin control mode, the SDI can read back the Σ-Δ results, depending on the level of the CONVST_SAR pin, as described in Table 13.

In SPI control mode, the SPI transfers data into the on-chip registers while the SDO pin reads back data from the on-chip registers or reads the SAR or the Σ-Δ conversions results, depending on the selected operation mode.

The SDO data source in SPI control mode is defined by the GENERAL_USER_CONFIG_2 and GENERAL_USER_CONFIG_3 registers, as described in Table 23.

Table 23. SPI Operation Mode in SPI Control Mode

GENERAL_USER_CONFIG_2, Bit 5 Setting	GENERAL_USER_CONFIG_3, Bit 4 Setting ¹	Mode
0	0	Internal register
0	1	Σ-Δ data conversion
1	X	SAR conversion

¹ X means don't care.

In SPI control mode, there are four different levels of input/output (I/O) strength on the SDO pin that can be selected in GENERAL_USER_CONFIG_2, Bits[4:3], as described in Table 24.

Table 24. SDO Strength

GENERAL_USER_CONFIG_2, Bits[4:3] Setting	Mode
00	Nominal
01	Strong
10	Weak
11	Extra strong

SCLK is the serial clock input for the device. All data transfers (on either SDO or SDI) occur with respect to this SCLK signal.

The SPI can operate in multiples of eight bits. For example, in SPI control mode, if the SDO pin is used to read back the data from the internal register or the SAR ADC, the data frame is 16 bits wide (CRC disabled), as shown in Figure 118, or 24 bits wide (CRC enabled), as shown in Figure 119. In this case, the controller can generate one frame of 16 bits or 24 bits (with and without the CRC enabled), or two or three frames of 8 bits (with and without the CRC enabled). When the SDO pin reads back the data from the Σ-Δ channels, 64 bits must be read back from the controller (in this case, the controller can generate a frame of 64 bits—either 2 × 32 bits, 4 × 16 bits, or 8 × 8 bits).

SPI CRC—Checksum Protection (SPI Control Mode)

The AD7771 has a checksum mode that improves SPI robustness in SPI control mode. Using the checksum ensures that only valid data is written to a register and allows data read from the device to be validated. The SPI CRC can be enabled by setting the SPI_CRC_TEST_EN bit. If an error occurs during a register write, the SPI_CRC_ERR is set in the error register.

Enabling the SPI_CRC_TEST_EN bit results in a CRC checksum being performed on all the R/W operations. When SPI_CRC_TEST_EN is enabled, an 8-bit CRC word is appended to every SPI transaction for SAR and register map operations. For more information on Σ-Δ readback operations, see the CRC Header section.

To ensure that the register write is successful, it is recommended to read back the register and verify the checksum.

For CRC checksum calculations, the following polynomial is always used: $x^8 + x^2 + x + 1$. See the SPI Control Mode Checksum section for more information.

SPI Read/Write Register Mode (SPI Control Mode)

The AD7771 has on-board registers to configure and control the device.

The registers have 7-bit addresses—the 7-bit register address on the SDI line selects the register for the read/write function. The 7-bit register address follows the R/W bit in the SDI data. The 8 bits on the SDI line following the 7-bit register address are the data to be written to the selected register if the SPI is a write transfer. Data on the SDI line is clocked into the AD7771 on the rising edge of SCLK, as shown in Figure 3.

The data on the SDO line during the SPI transfer contains the 8-bit 0010 0000 header: 8 bits of register data in the case of a read (R) operation, or 8 zeros in the case of a write (W) operation.

With the CRC disabled, the basic data frame on the SDI line during the transfer is 16 bits long, as shown in Figure 118. When the CRC is enabled, a minimum frame length of 24 SCLK periods are required on SPI transfers. The 24 bits of data on the SDO line consist of an 8-bit header (0010 0000), 8 bits of data, and an 8-bit CRC (see Figure 119).

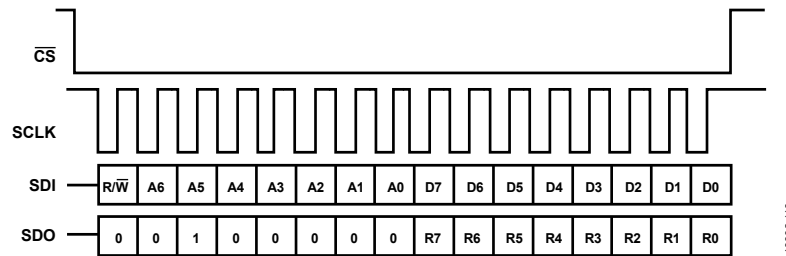

Figure 118. 16-Bit SPI Transfer—CRC Disabled

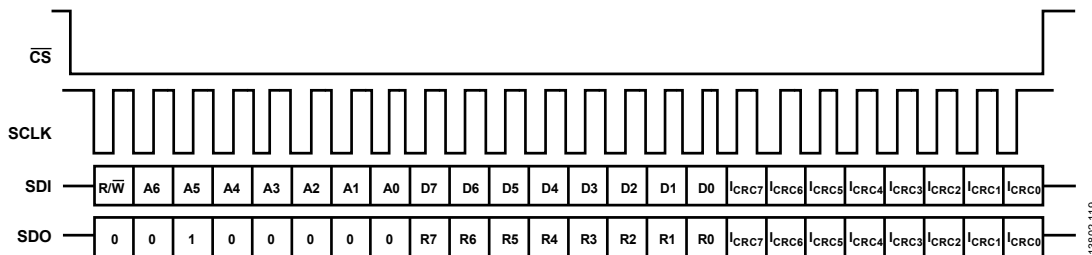

Figure 119. 24-Bit SPI Transfer—CRC Enabled

SPI SAR Diagnostic Mode (SPI Control Mode)

Setting Bit 5 in the GENERAL_USER_CONFIG_2 register configures the SDO line to shift out data from the SAR ADC conversions, as described in Table 23.

In SAR mode, the AD7771 internal registers can be written to, but any readback command is ignored because the SDO data frame is dedicated to shift out the conversion results from the SAR ADC.

To exit this mode of operation, reset Bit 5 in the GENERAL_USER_CONFIG_2 register.

The data on the SDO line during the SPI transfer contains a 4-bit 0010 header and the 12-bit SAR conversion result if the CRC is disabled.

When the CRC is enabled, a minimum frame length of 24 SCLK periods is required on SPI transfers. The 24 bits of data on the SDO line consist of a 4-bit header (0010), the 12-bit data, and an 8-bit CRC, as shown in Figure 120.

Per the SPI read/write register mode (see the SPI Read/Write Register Mode section), the SDI line contains the R/W bit, a 7-bit register address, the 8-bit data, and an 8-bit CRC (if enabled). To avoid unwanted writes to the internal register while the SAR conversions are read back through the SDO line, it is recommended to send a readback command, for example, 0x8000,

to the device, which is ignored because the SDO pin shifts out the content of the SAR ADC.

If consecutive conversions are performed in the SAR ADC, read back the result from the previous conversion before a new conversion is generated. Otherwise, the results are corrupted.

Σ - Δ Data, ADC Mode

In pin control mode, the SPI can be used to read back the Σ - Δ conversions as described in Table 13. In SPI control mode, the SPI reads back the Σ - Δ conversions by setting GENERAL_USER_CONFIG_3, Bit 4, as described in Table 23; in this mode, the AD7771 internal register can be written to, but any readback command is ignored because the SDO data frame is dedicated to shifting out the conversion results from the Σ - Δ ADCs. To avoid unwanted writes to the internal register, it is recommended to send a readback command, for example, 0x8000, to the device, which is ignored because the SDO pin shifts out the content of the Σ - Δ ADC.

The SDO pin data can be read back in any multiple of 8 bits, for example, as 64 bits, 2×32 bits, 4×16 bits, or 8×8 bits.

SPI Software Reset

Keeping the SDI pin high during 64 consecutive clocks generates a software reset.

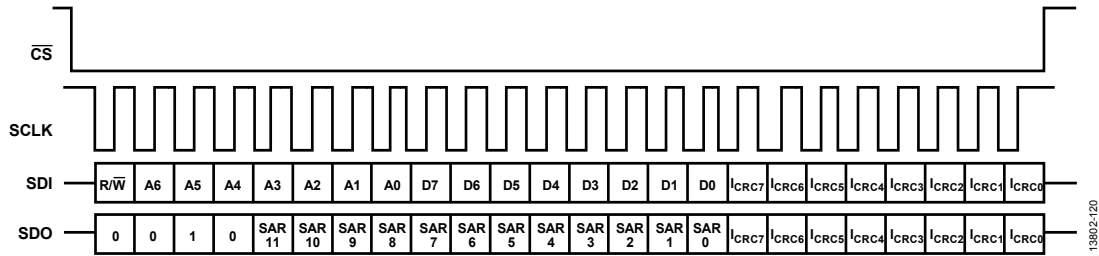

Figure 120. SAR ADC/Diagnostic Mode—CRC Enabled

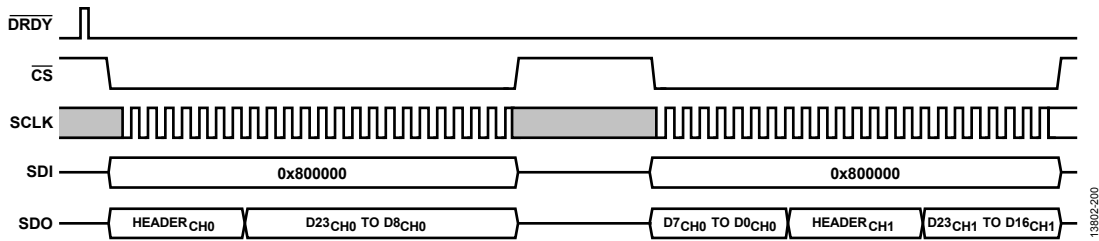

Figure 121. SPI Used to Read Back the Σ - Δ ADC Data, in 24-Bit Frames

RMS NOISE AND RESOLUTION

Table 25 through Table 28 show the dynamic range (DR), rms noise (RTI), effective number of bits (ENOB), and effective resolution (ER) of the AD7771 for various output data rates and gain settings. The numbers given are for the bipolar input range with an external 2.5 V reference. These numbers are typical and are generated with a differential input voltage of 0 V when the ADC is continuously converting on a single channel.

It is important to note that the effective resolution is calculated using the rms noise; 16,384 consecutive samples were used to calculate the rms noise.

$$\text{Effective Resolution} = \log_2(\text{Input Range}/\text{RMS Noise})$$

$$\text{ENOB} = (\text{DR} - 1.78)/6$$

HIGH RESOLUTION MODE

Table 25. DR and RTI for High Resolution Mode

Sinc Filter	Decimation Rate	Output Data Rate (SPS)	f _{-3 dB} (Hz)	Gain = 1		Gain = 2		Gain = 4		Gain = 8	
				DR (dB)	RTI (μV rms)	DR (dB)	RTI (μV rms)	DR (dB)	RTI (μV rms)	DR (dB)	RTI (μV rms)
Sinc5	16	128,000	26542.34	95.1	31.32	91.7	22.68	87.1	19.39	82.0	17.11
	32	64,000	13403.14	101.8	14.31	98.5	10.30	94.4	8.41	89.7	7.37
	64	32,000	6833.54	107.1	7.90	105.3	4.85	101.5	3.65	96.9	3.14
	256	8,000	1906.34	114.4	3.34	113.8	1.84	111.6	1.16	107.9	0.91
Sinc3	128	16,000	4878.83	105.7	9.01	105.2	4.88	103.2	2.99	99.6	2.26
	256	8,000	2756.43	112.1	4.32	111.5	2.31	109.3	1.52	105.5	1.19
	512	4,000	1695.23	115.8	2.86	115.6	1.51	113.5	0.96	109.5	0.75
	1024	1,000	899.33	122.0	1.39	121.6	0.73	119.6	0.47	115.7	0.36

Table 26. ENOB and ER for High Resolution Mode

Sinc Filter	Decimation Rate	Output Data Rate (SPS)	f _{-3 dB} (Hz)	Gain = 1		Gain = 2		Gain = 4		Gain = 8	
				ENOB (Bits)	ER (Bits)	ENOB (Bits)	ER (Bits)	ENOB (Bits)	ER (Bits)	ENOB (Bits)	ER (Bits)
Sinc5	16	128,000	26542.34	15.5	17.3	14.9	17.8	14.2	18.0	13.3	18.2
	32	64,000	13403.14	16.6	18.4	16.1	18.9	15.4	19.2	14.6	19.4
	64	32,000	6833.54	17.5	19.3	17.2	20.0	16.6	20.4	15.8	20.6
	256	8,000	1906.34	18.7	20.5	18.6	21.4	18.2	22.0	17.6	22.4
Sinc3	128	16,000	4878.83	17.3	19.1	17.2	20.0	16.9	20.7	16.3	21.1
	256	8,000	2756.43	18.3	20.1	18.2	21.0	17.9	21.6	17.2	22.0
	512	4,000	1695.23	18.9	20.7	18.9	21.7	18.6	22.3	17.9	22.7
	1024	1,000	899.33	20.0	21.8	19.9	22.7	19.6	23.3	18.9	23.7

LOW POWER MODE

Table 27. DR and RTI for Low Power Mode

Sinc Filter	Decimation Rate	Output Data Rate (SPS)	f _{-3 dB} (Hz)	Gain = 1		Gain = 2		Gain = 4		Gain = 8	
				DR (dB)	RTI (μV rms)	DR (dB)	RTI (μV rms)	DR (dB)	RTI (μV rms)	DR (dB)	RTI (μV rms)
Sinc5	16	32,000	6833.54	94.3	34.2	90.9	25.04	86.5	20.5	81.3	19.43
	32	16,000	3548.74	100.9	15.7	97.8	11.22	93.6	9.0	87.9	8.39
	64	8,000	1906.34	106.7	83.3	104.6	5.18	100.6	4.03	96.1	3.46
	512	1,000	469.24	117.1	25.2	116.8	1.29	114.4	8.41	110.7	0.67
Sinc3	64	8,000	2756.43	95.5	29.86	95.0	15.26	93.7	8.9	90.8	6.11
	128	4,000	1695.23	105.4	9.47	105.1	4.95	102.7	3.21	98.7	2.51
	256	2,000	1164.63	111.7	4.62	111.2	2.41	108.9	1.57	104.8	1.27
	1024	500	766.68	118.6	2.1	118.2	1.07	116.2	0.7	112.5	0.54

Table 28. ENOB and ER for Low Power Mode

Sinc Filter	Decimation Rate	Output Data Rate (SPS)	f _{-3 dB} (Hz)	Gain = 1		Gain = 2		Gain = 4		Gain = 8	
				ENOB (Bits)	ER (Bits)	ENOB (Bits)	ER (Bits)	ENOB (Bits)	ER (Bits)	ENOB (Bits)	ER (Bits)
Sinc5	16	32,000	6833.54	15.4	17.2	14.8	17.6	14.1	17.9	13.2	18.0
	32	16,000	3548.74	16.5	18.3	16.0	18.8	15.3	19.1	14.3	19.2
	64	8000	1906.34	17.4	15.9	17.1	19.9	16.4	20.2	15.7	20.5
	512	1000	469.24	19.2	17.6	19.1	21.9	18.7	19.2	18.1	22.8
Sinc3	64	8,000	2756.43	15.6	17.4	15.5	18.3	15.3	19.1	14.8	19.6
	128	4,000	1695.23	17.2	19.0	17.2	19.9	16.8	20.6	16.1	20.9
	256	2,000	1164.63	18.3	20.0	18.2	21.0	17.8	21.6	17.1	21.9
	1024	500	766.68	19.4	21.2	19.3	22.2	19.0	22.8	18.4	23.1

DIAGNOSTICS AND MONITORING

SELF DIAGNOSTICS ERROR

The AD7771 includes self diagnostic features to guarantee the correct operation. If an error is detected, the ALERT pin (Pin 18 when using pin control mode or Pin 16 when using SPI control mode) is pulled high to generate an external interruption to the controller. In addition, the header of the Σ - Δ output data contains an alert bit that informs the controller of a chip error (see the ADC Conversion Output—Header and Data section).

Both the ALERT pin and bit (status header) are automatically cleared if the error is no longer present. The errors related to the SPI do not recover automatically; read back the appropriate register to clear the error. The ALERT pin and bit reset in the next SPI access after the bit is read back.

If an error detector is manually disabled, it does not generate an internal error and, consequently, the register map or the ALERT pin and bit are not triggered.

There are different sources of errors, as described in Table 29. In pin control code, it is not possible to check the error source, and some sources of error are not enabled. In SPI control mode, check the source of an error by reading the appropriate register bit.

The STATUS_REG_x register bits identify the register that generates an error, as summarized in Table 29.

Table 29. Register Error Source

Bit Name	Register Source
ERR_LOC_GEN2	GEN_ERR_REG_2
ERR_LOC_GEN1	GEN_ERR_REG_1
ERR_LOC_CH7	CH7_ERR_REG
ERR_LOC_CH6	CH6_ERR_REG
ERR_LOC_CH5	CH5_ERR_REG
ERR_LOC_CH4	CH4_ERR_REG
ERR_LOC_CH3	CH3_ERR_REG
ERR_LOC_CH2	CH2_ERR_REG
ERR_LOC_CH1	CH1_ERR_REG
ERR_LOC_CH0	CH0_ERR_REG
ERR_LOC_SAT_CH6_7	CH6_7_SAT_ERR
ERR_LOC_SAT_CH4_5	CH4_5_SAT_ERR
ERR_LOC_SAT_CH2_3	CH2_3_SAT_ERR
ERR_LOC_SAT_CH0_1	CH0_1_SAT_ERR

In addition, the STATUS_REG_x registers have a bit that indicates if any internal error bit is set, CHIP_ERROR. This bit clears if the error is no longer present and the register is read back.

The INIT_COMPLETE bit in the STATUS_REG_3 indicates that the device is initialized correctly. This bit is not an error bit but an indicator.

General Errors

MCLK Switch Error (SPI Control Mode)

After power-up, the AD7771 initiates a clocking handover sequence to pass clocking control to the external oscillator, or

the CMOS clock. In SPI control mode, if an error occurs in the handover, the EXT_MCLK_SWITCH_ERR bit is set in the general error register, GEN_ERR_REG_2.

If EXT_MCLK_SWITCH_ERR is set, this means that the device is operating using the internal oscillator.

To use a slow external clock (<265 kHz), set the CLK_QUAL_DIS bit. Setting this bit also clears the error bit.

If the external clock is between 132 kHz and 265 kHz, depending on the internal synchronization between the internal oscillator and the external clock, the error may not trigger. However, it is still recommended to set the CLK_QUAL_DIS bit.

If a slow clock is not in use and the error triggers, a reset is required.

Reset Detection

The AD7771 general error register contains a RESET_DETECTED bit. This bit is asserted if a reset pulse is applied to the AD7771 and is cleared by reading the general error register. This bit indicates that the power-on reset (POR) initialized correctly on the device. In addition, this bit can be used to detect an unexpected device reset or glitch on the RESET pin. To reset this error signal in SPI control mode, toggle the SYNC_IN pin or read from the general error register, GEN_ERR_REG_2. To reset this error signal in pin control mode, toggle the SYNC_IN pin.

Internal LDO Status

The AD7771 has three internal LDOs to regulate the internal analog and digital supply rails. The LDOs have internal power supply monitors. Internal comparators monitor and flag errors with these supplies after they pass a predetermined limit.

The ALDO1_PSM_ERR, ALDO2_PSM_ERR, and DLDO_PSM_ERR bits indicate either an LDO malfunction, or, if the LDOs are bypassed, an incorrect external supply.

The internal analog and digital voltage monitors can be disabled by appropriately selecting the LDO_PSM_TEST_EN bits.

Use the SAR ADC to verify the error.

Additionally, the levels of the internal monitors can be manually triggered to check if the detector works correctly by appropriately setting the LDO_PSM_TRIP_TEST_EN bits. These bits increase the comparator window threshold above the LDO outputs, forcing the comparator to trigger.

ROM and Memory Map CRC

If an error is found at power-up during the ROM verification, or if the internal memory map is corrupted, the AD7771 generates an error and sets MEMMAP_CRC_ERR or ROM_CRC_ERR, depending on the source of the error.

The checker can be disabled by clearing the MEMMAP_CRC_TEST_EN and ROM_CRC_TEST_EN bits.

The device must be reset if any of these errors trigger.

Σ - Δ ADC Errors

Reference Detect (SPI Control Mode)

In SPI control mode, the AD7771 includes on-chip circuitry to detect if there is a valid reference for conversions or calibrations. If the voltage between the selected REFx+ and REFx- pins goes below 0.7 V, the AD7771 detects that it no longer has a valid reference. CHx_ERR_REF_DET can be interrogated to identify the affected channel, which clears the bits if the error is no longer present. The voltage detector can be disabled by clearing the REF_DET_TEST_EN bit.

Use the Σ - Δ ADC diagnostic or the SAR ADC to verify the error.

Overvoltage and Undervoltage Events

The AD7771 includes on-chip overvoltage/undervoltage circuitry on each analog input pin. When the voltage on an analog input pin goes above AVDD1x + 0.04 mV, the CHx_ERR_AINx_OV bit is set. The error disappears if the input voltage falls below AVDD1x - 40 mV.

If an undervoltage event occurs (AVSSx - 40 mV), the CHx_ERR_AINx_UV bit is set. The error disappears if the input voltage increases to AVSSx + 0.04 V.

The CHx_ERR_AINM_UV, CHx_ERR_AINM_OV, CHx_ERR_AINP_UV, and CHx_ERR_AINP_OV bits can be read back to verify the affected channel input, which clears the bits if the error is no longer present. The overvoltage and undervoltage detection can be disabled independently by clearing the AINM_UV_TEST_EN, AINM_OV_TEST_EN, AINP_UV_TEST_EN, or AINP_OV_TEST_EN bit.

The input voltage can be checked independently with the SAR ADC.

Modulator Saturation

The AD7771 includes modulator saturation detection on each of the Σ - Δ ADCs. If 20 consecutive codes for the modulator are either all 1s or 0s, this condition is flagged as a modulator saturation event. Reading CHx_ERR_MOD_SAT clears the bit if the error corrects itself.

Modulator saturation detection can be disabled by clearing the MOD_SAT_TEST_EN bit.

Note that the modulator input voltage is attenuated internally, which means that a modulator output of all 1s or 0s represents a modulator that is out of bounds and that a RESET pulse is required.

Filter Saturation

The AD7771 includes digital filter saturation detection on each Σ - Δ ADC channel. This detection indicates that the filter output is out of bounds, which represents an output code approximately 20% higher than positive or negative full scale. Reading the CHx_ERR_FILTER_SAT bit clears the bit if the error corrects itself.

The detection can be disabled by clearing FILTER_SAT_TEST_EN bit.

Output Saturation

An output saturation event can occur when gain and offset calibration causes the output from the digital filter to clip at either positive or negative full scale. The output does not wrap. Reading the CHx_ERR_OUTPUT_SAT bit clears the bit if the error corrects itself.

The detection can be disabled by clearing OUTPUT_SAT_TEST_EN bit.

SPI Transmission Errors (SPI Control Mode)

All SPI errors clear after reading GEN_ERR_REG_1, which contains the SPI errors. These errors are not recovered automatically and, consequently, the ALERT pin and the ALERT bit remain set until the error register is read back.

CRC Checksum Error

If the CRC checksum is enabled by setting the SPI_CRC_TEST_EN bit, an error bit, SPI_CRC_ERR, is raised if the CRC message does not match the message computed by the AD7771 internal CRC block. If the CRC message does not match the internally computed message, the register is not updated.

SCLK Counter

If the number of clocks generated by the controller is not a multiple of 8 after CS is pulled high, an error bit, SPI_CLK_COUNT_ERR is raised. The last command multiple of 8 is executed; however, the SCLK counter can be disabled by setting the SPI_CLK_COUNT_TEST_EN bit.

Invalid Read

When attempting to read back an invalid register address, the SPI_INVALID_READ_ERR bit is set.

The invalid readback address detection can be disabled by setting the SPI_INVALID_READ_TEST_EN bit.

Invalid Write

When attempting to write to an invalid register address, the SPI_INVALID_WRITE_ERR bit is set.

The invalid write address detection can be disabled by setting the SPI_INVALID_WRITE_TEST_EN bit.

MONITORING USING THE AD7771 SAR ADC (SPI CONTROL MODE)

The AD7771 contains an on-chip SAR ADC for chip diagnostics, system diagnostics, or measurement verification. The SAR ADC has a 12-bit resolution. The AVDD4 and AVSS4 pins operate in complete independence of the Σ - Δ ADC supplies and, therefore, can be used for chip diagnostics in systems where functional safety is important. The reference for the SAR conversion process is taken from the SAR ADC supply voltage (AVDD4/AVSS4) and, therefore, the SAR analog input range is from AVSS4 to AVDD4.

The SAR ADC has a maximum throughput rate of 256 kSPS. The CONVST_SAR pin initiates a conversion on the SAR ADC. The maximum allowable frequency of the CONVST_SAR pin is 256 kHz. If consecutive conversions are performed in the SAR ADC, read back the result from the previous conversion before a new conversion is generated. Otherwise, the results are corrupted.

The SAR ADC is only available in SPI control mode. To read conversion results from the SAR ADC, set the SAR_DIAG_MODE_EN bit. After this bit is set, all data shifted out from the SDO pin originates from the SAR ADC conversion, as shown in Figure 122.

The CONVST_SAR signal can be internally deglitched to avoid false triggers.

Table 30. SAR Synchronization and Deglitching

CONVST_DEGLITCH_DIS (Register 0x013, Bits[7:6])	Effect on CONVST_SAR
11	CONVST_SAR goes directly to the SAR
10	CONVST_SAR reaches the SAR when it is 1.5/MCLK cycles wide

Increase the acquisition time by 1.5/MCLK when the deglitch circuitry is enabled.

Prior to the SAR ADC, the AD7771 contains an internal multiplexer. This multiplexer can be configured over the SPI to set the inputs to the SAR ADC to be either internal circuit nodes (in the case of diagnostics) or to select the external AUXAIN+ and AUXAIN– pins.

Along with converting external voltages, the SAR ADC monitors the internal nodes on the AVDD, IOVDD, and DGND pins, and the DLDO and analog LDO (ALDO) outputs. Some voltages are internally attenuated by 6, and the resulting voltage is applied to the SAR ADC, as shown in Table 31. This is useful because variations in the power supply voltage can be monitored.

The input multiplexer of the SAR is controlled by the GLOBAL_MUX_CONFIG register, and the different inputs available are described in Table 31.

The SAR ADC also contains an SAR driver amplifier, as shown in Figure 123. This amplifier settles the SAR input to 12-bit accuracy within the t_{33} time. This driver amplifier helps minimize the kickback from the SAR converter to the global diagnostic mux input circuit nodes.

Use the auxiliary inputs, AUXAIN+ and AUXAIN–, to validate the Σ - Δ measurements. While operating in SPI control mode, the AD7771 has three available GPIOx ports controlled via the SPI. The GPIOx pins can be used to control an external, dual 8:1 multiplexer, which, in turn, samples the eight Σ - Δ channels. Use this diagnostic in applications where functional safety is required. This diagnostic aids in removing the need for a secondary external ADC to validate primary measurements on the Σ - Δ channels.

Temperature Sensor

The internal die temperature can be measured with an accuracy of $\pm 2^\circ\text{C}$. The differential voltage base emitter (DV_{BE}) is proportional to the temperature measured referred to 25°C .

$$\text{Temperature } (^\circ\text{C}) = \frac{DV_{BE} - 0.6 \text{ V}}{2 \text{ mV}}$$

Table 31. SAR Mux Inputs

SAR Input	Positive Signal	Negative Signal	Attenuation $\div 6$
0	AUXAIN+	AUXAIN–	No
1	DV_{BE}	AVSSx	No
2	REF1+	REF1–	No
3	REF2+	REF2–	No
4	REF_OUT	AVSSx	No
5	VCM	AVSSx	No
6	AREG1CAP	AVSSx	Yes
7	AREG2CAP	AVSSx	Yes
8	DREGCAP	DGND	Yes
9	AVDD1A	AVSSx	Yes
10	AVDD1B	AVSSx	Yes
11	AVDD2A	AVSSx	Yes
12	AVDD2B	AVSSx	Yes
13	IOVDD	DGND	Yes
14	AVDD4	AVSSx	No
15	DGND	AVSSx	Yes
16	DGND	AVSSx	Yes
17	DGND	AVSSx	Yes
18	AVDD4	AVSSx	Yes
19	REF1+	AVSSx	No
20	REF2+	AVSSx	No
21	AVSSx	AVDD4	Yes

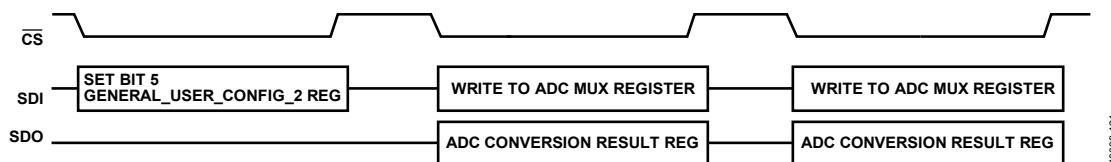

Figure 122. Configuring the AD7771 to Operate the SPI to Read from the SAR ADC

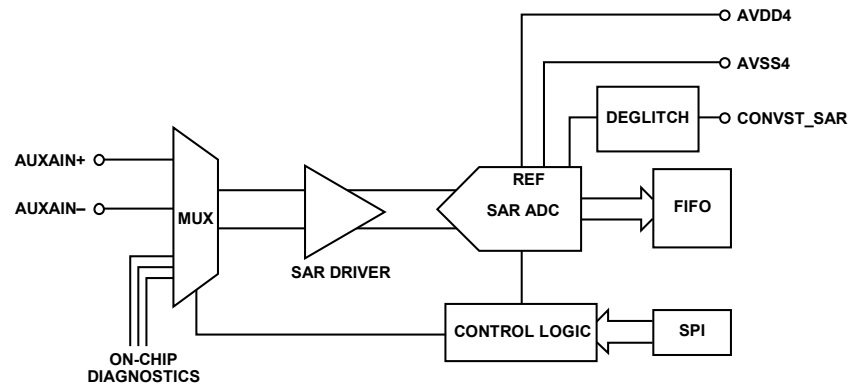

Figure 123. SAR ADC Configuration and Control

Table 32. Σ - Δ Diagnostic

Input	Voltage	Recommended Voltage Reference	Notes/Result
0	Floating	Not applicable	Not applicable
1	Floating	Not applicable	Not applicable
2	280 mV differential signal	Internal/external	PGA gain verification
3	External reference, positive/negative	External	Positive full scale
4	External reference, negative/positive	External	Negative full scale
5	External reference, negative/negative	External	Zero scale
6	Internal reference, positive/negative	Internal	Positive full scale
7	Internal reference, negative/positive	Internal	Negative full scale
8	Internal reference, positive/positive	Internal	Zero scale
9	External reference, positive/positive	External	Zero scale

Σ - Δ ADC DIAGNOSTICS (SPI CONTROL MODE)

The AD7771 Σ - Δ ADC diagnostic functions are accessible through the SPI. The internal mux placed before the PGA has different inputs, allowing the user to select a zero-scale, positive full-scale, or negative full-scale input to the Σ - Δ ADC, which can be converted to verify the correct operation of the Σ - Δ ADC channel.

The diagnostic mux control signals are shared across all the Σ - Δ channels. Depending on the diagnostic selected, connect the Σ - Δ ADC reference to a different reference source to guarantee that the conversion is within the measurable range.

There are two different ways to enable the diagnostic mux, as follows:

- Setting the CH_x_RX bit. This bit enables the input Σ - Δ mux. The multiplexer inputs are described in Table 32. The reference used during the conversions are controlled by the REF_MUX_CTRL bits.
- Setting CH_x_REF_MONITOR. This bit has the same effect as enabling the CH_x_RX bit and selects the VDD1_x/AVSS_x supplies as the main reference.

If the AIN_x \pm pin is connected to AVSS_x, the input range is outside the range of AVSS_x + 100 mV; therefore, results may differ slightly from the expected value.

Alternatively, the inputs can be used to calibrate gain and offset errors.

Σ-Δ OUTPUT DATA

ADC CONVERSION OUTPUT—HEADER AND DATA

The AD7771 Σ-Δ conversion results are output on the DOUT0 to DOUT3 pins or over the SPI, depending on the selected interface. If the DOUTx interface is selected, the AD7771 acts as the master in the transmission. If the SPI is selected, the controller is the master.

The $\overline{\text{DRDY}}$ signal indicates the end of conversion independent of the interface selected to read back the Σ-Δ conversion. When the SPI reads back the Σ-Δ conversion, if a new conversion is completed ($\overline{\text{DRDY}}$ falling edge) before the previous conversion is read back, the results from previous conversion are overwritten and, consequently, the previous conversion data is corrupted.

For each channel, the width is 32 bits long: 8 bits for the header and 24 bits for the Σ-Δ conversion, as shown in Figure 124.

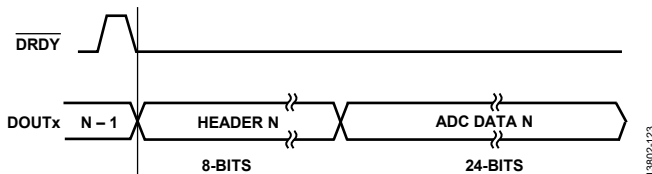

Figure 124. ADC Output—8-Bit Header Plus 24-Bit Conversion Data

In pin control mode, the header is fixed to the CRC while in SPI mode, and can be selected between the CRC and error headers.

CRC Header

The CRC header is the header generated in pin control mode or in SPI control mode if DOUT_HEADER_FORMAT is set.

As shown in Figure 125, the header consists of an alert bit, three bits for the ADC channel ID, as shown in Table 33, and four bits for the CRC.

The alert bit is set high if an error is detected in any channel, as explained in the General Errors section. The alert bit remains set to 1 until the error disappears.



Figure 125. CRC Header

Table 36. Status Header Output

Bits	Name	Description
7	Alert	This bit is set high if any of the enabled diagnostic functions have detected an error, including an external clock not detected, a memory map bit flip, or an internal CRC error. This bit is not channel specific. This bit clears if the error is no longer present.
6:4	CH_ID_[2:0]	These bits indicate which ADC channel the following conversion data came from (see Table 33).
3	RESET_DETECTED	This bit indicates if a reset condition occurs. This bit is not channel specific.
2	MODULATOR_SATURATE	This bit indicates that the modulator output is 20 consecutive 0s or 1s. The bit resets automatically after the error is no longer present.
1	FILTER_SATURATE	This bit indicates that the filter output is out of bounds. The bit resets automatically after the error is no longer present.
0	AIN_OV_UVERROR	This bit indicates that there is an AINx± overvoltage/undervoltage condition on the inputs. This bit is set until the appropriate register is read back and the error is no longer present.

Table 33. Channel ID

Channel	CH_ID_2	CH_ID_1	CH_ID_0
0	0	0	0
1	0	0	1
2	0	1	0
3	0	1	1
4	1	0	0
5	1	0	1
6	1	1	0
7	1	1	1

The CRC generated is eight bits long; the 4 MSBs are placed on the header for the first channel in the pairing and the 4 LSBs on the header of the second channel in the pairing, as shown in Table 34. If a channel is disabled, the 24-bit output data for this channel is 0x000000.

Table 34. 8-Bit CRC, Header Configuration (Channel 2)

CE	0	1	0	CRC7	CRC6	CRC5	CRC4

Table 35. 8-Bit CRC, Header Configuration (Channel 3)

CE	0	1	1	CRC3	CRC2	CRC1	CRC0

Error Header (SPI Control Mode)

In SPI control mode, the default header can be replaced by an error header. If the Σ-Δ conversion is read back through the SPI, disable the CRC by clearing the SPI_CRC_TEST_EN bit. If the DOUTx interface is used, clear the DOUT_HEADER_FORMAT bit.

The error header provides information of common error sources specific for each channel, as shown in Table 36. Modulator and filter errors are indicated even if the checker for these errors are specifically disabled, as described in the Σ-Δ ADC Errors section.

SAMPLE RATE CONVERTER (SRC) (SPI CONTROL MODE)

The AD7771 implements a patented feature called the SRC on each Σ - Δ channel that allows the user to configure the output data rate or sampling frequency to any desired value, including noninteger values. The SRC achieves fine resolution control over the Σ - Δ ADC ODR, up to 15.2 μ SPS. In applications where the ODR must change based on changes in the input signal to maintain sampling coherency, the SRC provides fine control over the ODR. For example, to achieve the highest classification standard, Class A, in power quality applications, coherency must be maintained for 0.01 Hz changes in the input power line. Use the SRC to achieve this sampling frequency accuracy.

In pin control mode, the ODR is fixed per the predefined pin control options. Consequently, a noninteger number cannot be selected, as shown in Table 13.

To set the ODR, the user must program up to four registers, depending on the decimation value: two registers to program the integer value, N (the effective decimation rate), and two registers to program the decimal value, the interpolation factor (IF).

The integer value registers are SRC_N_MSB, Bits[3:0] and SRC_N_LSB, Bits[7:0]. The decimal part value registers are SRC_IF_MSB, Bits[7:0] and SRC_IF_LSB, Bits[7:0].

As an example, if an output data rate of 2.8 kHz is required, the decimation rate equates to

- High resolution mode = $2048/2.8 = 731.428$
- Low power mode = $512/2.8 = 182.857$

The register values for high resolution mode are as follows:

- 731 (decimal) = 0x2DB
- SRC_N_MSB, Bits[3:0] = 0x02
- SRC_N_LSB, Bits[7:0] = 0xDB
- 0.428 (decimal) = $0.428 \times 2^{16} = 28049$ (decimal) = 0x6D91
- SRC_IF_MSB, Bits[7:0] = 0x6D
- SRC_IF_LSB, Bits[7:0] = 0x91

The SRC resolution depends on the decimal number used in the decimation, as well as the modulator clock (MOD_MCLK), as follows:

$$Resolution = \frac{MOD_{MCLK}}{2^{16} \times DEC^2 + 3 \times DEC + 2 \times \frac{1}{2^{16}}}$$

where:

MOD_{MCLK} is the modulator frequency.

DEC is the decimal portion of the decimation rate.

In high resolution mode, for a decimal decimation of 450, the resolution is defined as

$$\frac{2048}{2^{16} \times 450^2 + 3 \times 450^2 \times \frac{1}{2^{16}}} = 15.2 \times 10^{-6} \text{ SPS}$$

The ODR can be updated on the fly, but a new ODR is effective in three conversion cycles of the Σ - Δ ADCs. This condition guarantees a smooth transition with no conversion results out of range.

There are two different ways to change the ODR after a new value is written in the SRC registers: via software or via hardware, depending on the SRC_LOAD_SOURCE bit (SRC_UPDATE register, Bit 7).

If the SRC_LOAD_SOURCE bit is clear, the new ODR value is updated by setting the SRC_LOAD_UPDATE bit to 1. This bit must be held high for at least two MCLK periods; return the bit to 0 before attempting another update.

If SRC_LOAD_SOURCE is set, the GPIO0 pin controls the ODR update externally. Apply a pulse in the GPIO2 pin, which is then internally synchronized with the external MCLK clock, and the resultant synchronous signal is output on the GPIO1 pin.

The GPIO1 and GPIO0 pins must be externally connected.

If multiple AD7771 devices must be synchronized, the GPIO1 pin of one device can be connected to multiple devices. This synchronization method requires the use of a common MCLK signal for all the AD7771 devices connected, as shown in Figure 126.

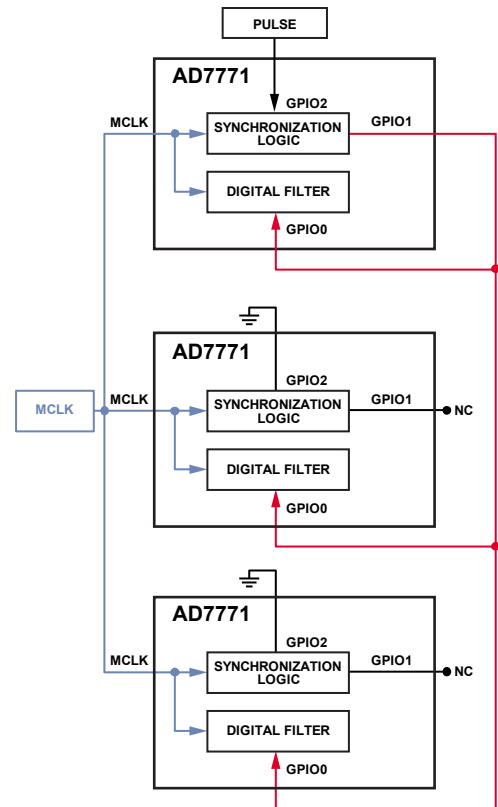

Figure 126. Hardware ODR Update

13802-125

SRC Bandwidth

The sinc3 and sinc5 filters architecture allows the user to select a noninteger value as the decimation range. This versatility means that the filter notches must be adjusted dynamically: two notches (sinc3) or four notches (sinc5) at the variable frequency, and one fixed notch to remove the PGA chopping tone. Consequently, the traditional formula for the -0.1 dB and -3 dB bandwidth must be adjusted depending on the selected decimation rate.

The bandwidth transfer function is not linear but can be approximated by using a linear function.

Figure 127 to Figure 130 show the correction factor for the -0.1 dB and -3 dB bandwidth, respectively. In low power mode, the offset must be divided by 4. For example, for sinc5 when the ODR = 1000 SPS, the -0.1 dB point is

$$BW = 0.0377 \times 1000 + \frac{49.355}{4} = 50.03 \text{ Hz}$$

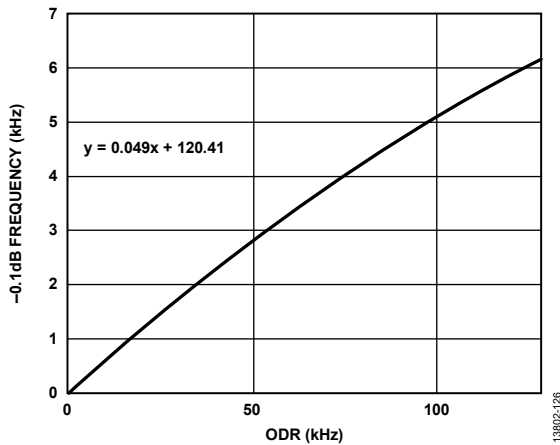

Figure 127. -0.1 dB Correction Factor, Sinc3 Filter Enabled

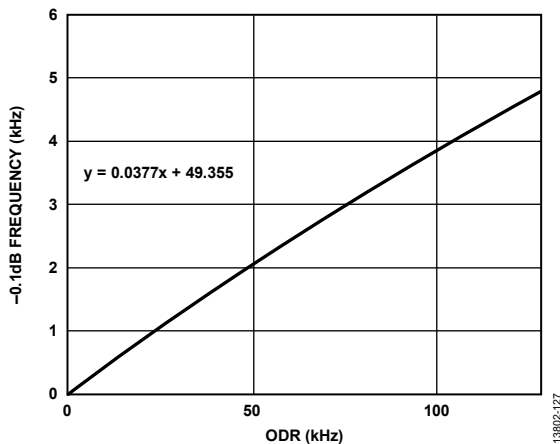

Figure 128. -0.1 dB Correction Factor, Sinc5 Filter Enabled

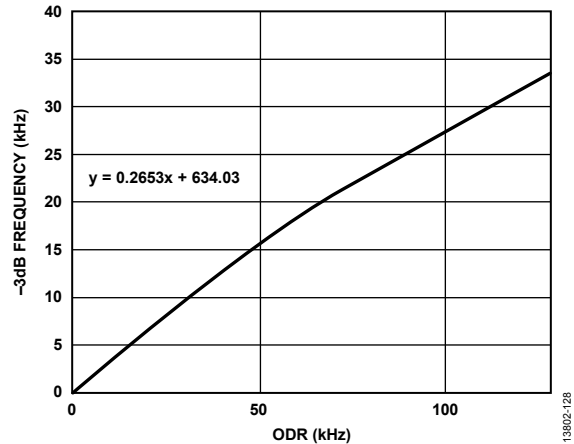

Figure 129. -3 dB Correction Factor, Sinc3 Filter Enabled

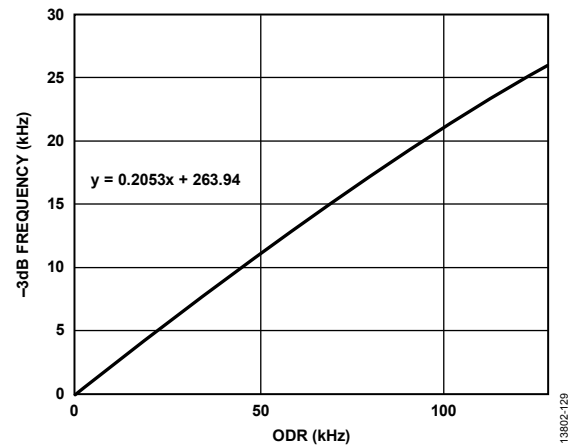

Figure 130. -3 dB Correction Factor, Sinc5 Filter Enabled

SRC Group Delay

The SRC group delay depends on the selected ODR and is defined by the following equation:

$$SRC \text{ Group Delay} = \frac{PM + SRC_N}{SRC_N \times ODR}$$

where:

PM is a constant equal to 8.

SRC_N is the integer value of the programmed ODR.

ODR is the programmed output data rate.

When using the sinc5 filter, the equation that defines the group delay is

$$SRC \text{ Group Delay} = \frac{PM + 2 \times SRC_N}{SRC_N \times ODR}$$

The latency is the contribution of the group delay and the calibration time.

$$Latency = Group \text{ Delay} + t_{CAL}$$

In high resolution mode, the calibration delay is defined as $62 \times t_{MCLK}$, with a maximum error of $2 \times t_{MCLK}$. In low power mode, the calibration delay is defined as $121 \times t_{MCLK}$, with a maximum error of $4 \times t_{MCLK}$. t_{MCLK} is the modulator period and is 488 ns in high resolution mode and 1.9 μ s in low power mode.

Settling Time

The settling time is defined by the contribution of all the internal stages, the filter delay, and the block calibration.

When using the sinc3 filter option, the filter delay is defined as 3/ODR. In some extreme cases, such as when an external pulse is applied, this value may increase to 4/ODR. If using the sinc5 filter, the filter delay is defined as 5/ODR, or 6/ODR for extreme cases.

DATA OUTPUT INTERFACE

The Σ - Δ output data interface is defined by the CONVST_SAR, FORMAT0, and FORMAT1 pins in pin control mode at power-up. The FORMATx pins cannot be changed dynamically. Table 14 shows the available options for pin control mode. If the device

is configured in SPI control mode, the SPI_SLAVE_MODE_EN bit enables the SPI to transmit the Σ - Δ ADC conversion results, as shown in Table 23.

DOUT3 to DOUT0 Data Interface Standalone Mode

In standalone mode, the AD7771 interface acts as a master. There are three different DOUT configurations, configurable through the FORMATx pins in pin control mode, as shown in Figure 131 through Figure 133, or via the DOUT_FORMAT bits, Bits[7:6], in SPI control mode, as described in Table 37.

Figure 134, Figure 135, and Figure 136 show the expected data outputs for different DOUTx output modes.

Table 37. DOUTx Channels

DOUT_FORMAT Bits/ FORMATx Pins	Number of DOUTx Lines Enabled	Associated Channels
00	4	DOUT0—Channel 0 and Channel 1 DOUT1—Channel 2 and Channel 3 DOUT2—Channel 4 and Channel 5 DOUT3—Channel 6 and Channel 7
01	2	DOUT0—Channel 0, Channel 1, Channel 2, and Channel 3 DOUT1—Channel 4, Channel 5, Channel 6, and Channel 7
10 or 11	1	DOUT0—Channel 0, Channel 1, Channel 2, Channel 3, Channel 4, Channel 5, Channel 6, and Channel 7

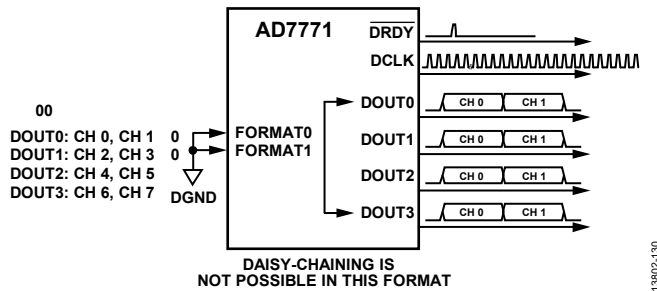

Figure 131. FORMATx Pin Configuration—FORMAT0 = 0, FORMAT1 = 0

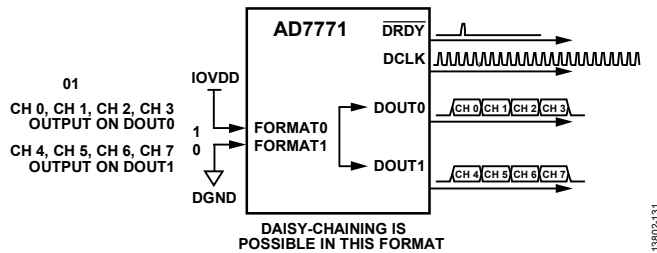

Figure 132. FORMATx Pin Configuration—FORMAT0 = 1, FORMAT1 = 0

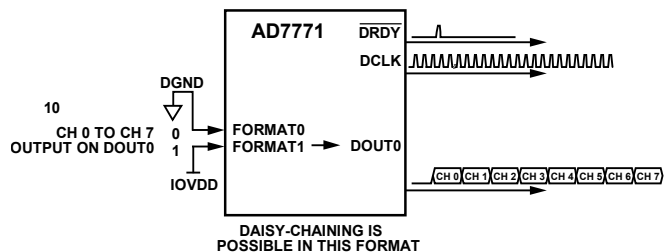

Figure 133. FORMATx Pin Configuration—FORMAT0 = 0, FORMAT1 = 1

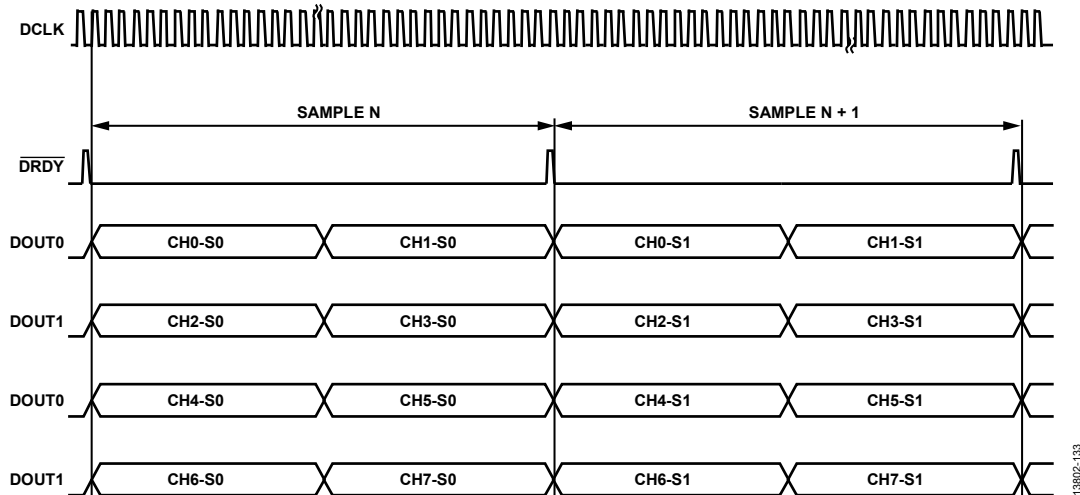

Figure 134. $FORMAT0 = 0, FORMAT1 = 0$ —Each $DOUTx$ Outputs Two ADC Conversions (S0 Means Sample 0 and S1 Means Sample 1)

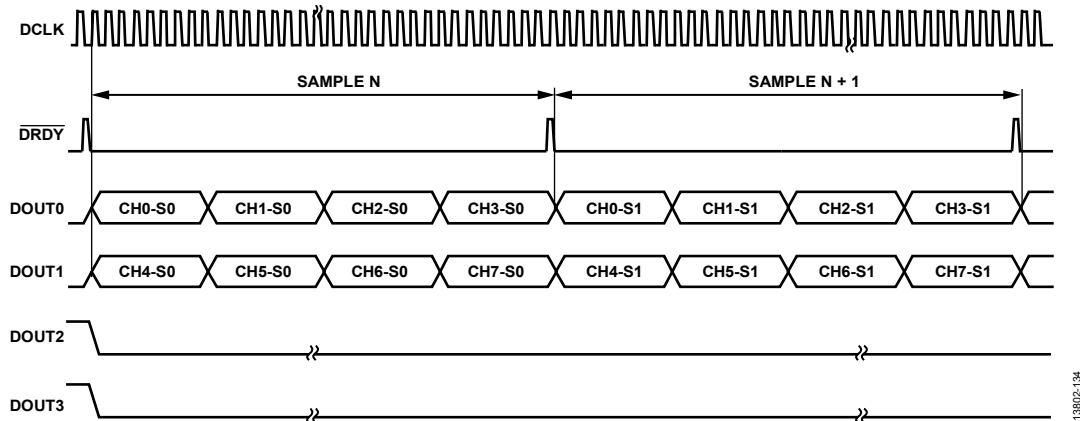

Figure 135. $FORMAT0 = 0, FORMAT1 = 1$ —Channel 0 to Channel 3 Share $DOUT0$, and Channel 4 to Channel 7 Share $DOUT1$ (S0 Means Sample 0 and S1 Means Sample 1)

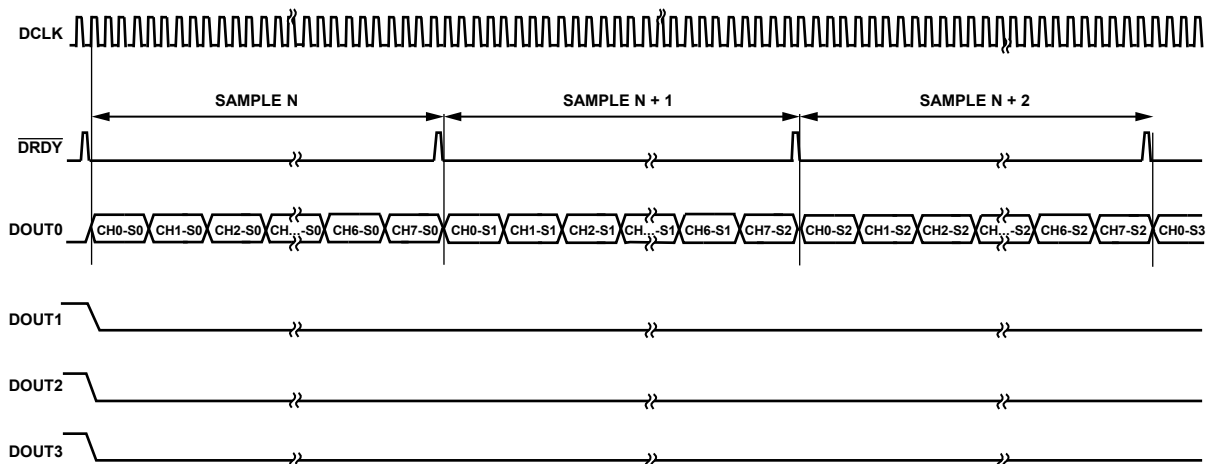

Figure 136. $FORMAT0 = 1, FORMAT1 = 0$ —Channel 0 to Channel 7 Output on $DOUT0$ Only (S0 Means Sample 0 and S1 Means Sample 1)

Daisy-Chain Mode

Daisy-chaining devices allows numerous devices to use the same data interface lines by cascading the outputs of multiple ADCs from separate AD7771 devices. In daisy-chain configuration, only one device has a direct connection between the DOUTx interface and the digital host. For the AD7771, daisy-chain capability is implemented by cascading DOUT0 and DOUT1 through a number of devices, or by just using DOUT0 (the number of DOUTx pins available depends on the selected DOUTx mode). The ability to daisy-chain devices and the limit on the number of devices that can be handled by the chain is dependent on the selected DOUTx mode and the decimation rate employed.

When operating in daisy-chain mode, it is required that all AD7771 devices in the chain are correctly synchronized. See

the Digital Reset and Synchronization Pins section for more information.

This feature is especially useful for reducing the component count and wiring connections in, for example, isolated multiconverter applications or for systems with a limited interfacing capacity.

For daisy-chain operation, there are two different configurations possible, as described in Table 38.

Using the FORMATx = 10 mode, DOUT2 acts as an input pin, as shown in Figure 137. In this case, the DOUT0 pin of the AD7771 devices is cascaded to the DOUT2 pin of the next device in the chain. Data readback is analogous to clocking a shift register where data is clocked on the rising edge of DCLK.

Table 38. DOUTx Modes in Daisy-Chain Operation

DOUT_FORMAT Bits/ FORMATx Pins	Number of DOUTx Lines Enabled	Associated Channels
01	2	DOUT0—Channel 0 to Channel 3 and DOUT2 DOUT1—Channel 4 to Channel 7 and DOUT3 DOUT2—input channel DOUT3—input channel
10	1	DOUT0—Channel 0 to Channel 7 and DOUT2 DOUT2—input channel

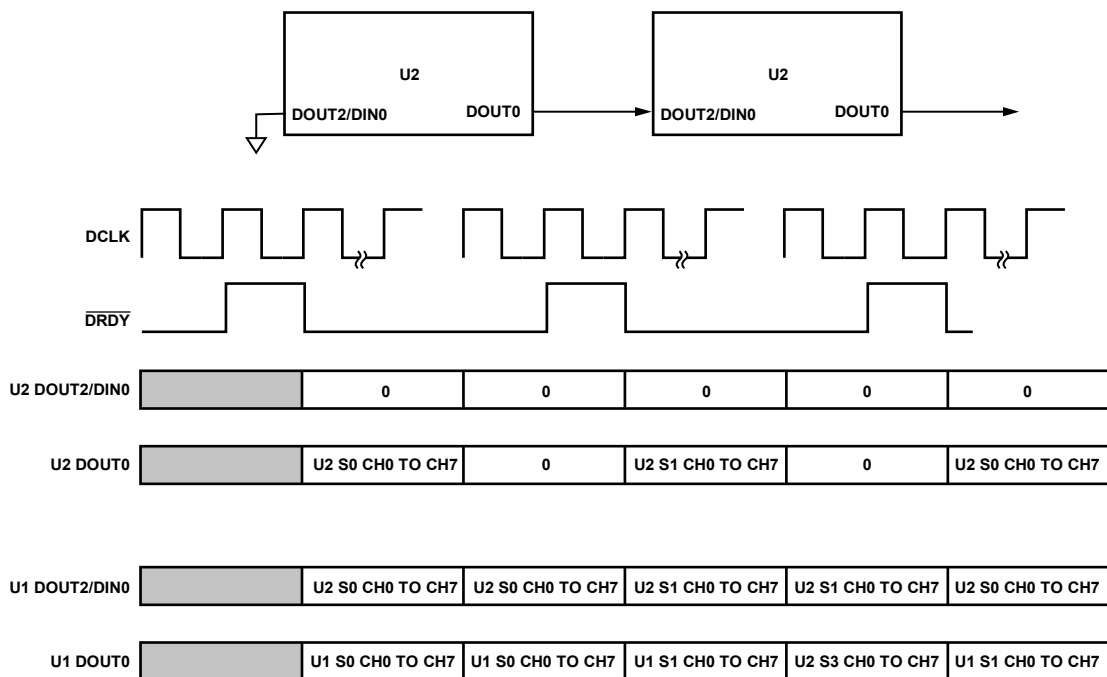

Figure 137. Daisy-Chain Connection Mode, FORMAT0 = 1, FORMAT1 = 0 (S0 Means Sample 0 and S1 Means Sample 1); When Connected in Daisy-Chain Mode, DOUT2 Acts as an Input Pin, Represented by DIN0

Minimum DCLKx Frequency

Select the DCLKx frequency ratio in such a way that the data is completely shifted out before a new conversion is completed; otherwise, the previous conversion is overwritten and the transmission becomes corrupt. The minimum DCLKx frequency ratio is defined by the decimation rate, the operation mode, and the lines enabled on the DOUT3 to DOUT0 data interface as described in the following equations:

In standalone, high resolution mode,

$$DCLK_{MIN_RATIO} < Decimation / (8 \times DOUT_FORMAT)$$

In standalone, low power mode,

$$DCLK_{MIN_RATIO} < Decimation / (4 \times DOUT_FORMAT)$$

In daisy-chain, high resolution mode,

$$DCLK_{MIN_RATIO} < Decimation / (8 \times Devices \times DOUTx\ Channels)$$

In daisy-chain, low power mode,

$$DCLK_{MIN_RATIO} < Decimation / (4 \times Devices \times DOUTx\ Channels)$$

As an example, when operating in master interface mode, FORMATx = 01, the DOUT0 and DOUT1 pins shift out four Σ - Δ channels each and, assuming a maximum output rate in high resolution mode, the decimation = 128.

$$DCLK_{MIN} < 128 / (8 \times 4) = 4$$

If the DCLK_{MIN_RATIO} is selected above the necessary minimum, a Logic 0 is continuously transmitted until a new sample is available.

An example in daisy-chain mode, assuming FORMATx = 01, and with three devices connected and a decimation rate of 256 in high resolution mode, is as follows:

$$DCLK_{MIN_RATIO} < 256 / (8 \times 3 \times 4) = 2.66 = 2$$

The different ratios are summarized in Table 39.

Table 39. Available DCLK Ratios

DCLK_CLK_DIV (SPI Control Mode), DCLKx (Pin Control Mode)	DCLKx Ratio
000	1
001	2
010	4
011	8
100	16
101	32
110	64
111	128

There are maximum achievable ODRs and minimum DCLKx frequencies required for a given DOUTx pin configuration, as shown in Table 40 and Table 41.

Table 40. Maximum ODRs and Minimum DCLKx Frequencies in High Resolution Mode

Decimation Rate	ODR (kSPS)	Minimum DCLKx (kHz) ¹		
		1 × DOUTx	2 × DOUTx	4 × DOUTx
4095	0.500122	128	64	32
2048	1	256	128	64
1024	2	512	256	128
512	4	1024	512	256
256	8	2048	1024	512
128	16	4096	2048	1024
64	32	8192	4096	2048
32	64	N/A	8192	4096
16	128	N/A	N/A	8192

¹ N/A means not applicable.

Table 41. Maximum ODRs and Minimum DCLK Frequencies in Low Power Mode

Decimation Rate	ODR (kSPS)	Minimum DCLKx (kHz)		
		1 × DOUTx	2 × DOUTx	4 × DOUTx
2048	0.25	64	32	16
1024	0.5	128	64	32
512	1	256	128	64
256	2	512	256	128
128	4	1024	512	256
64	8	2048	1024	512
32	16	4096	2048	1024
16	32	N/A ¹	4096	2048

¹ N/A means not applicable.

If the AD7771 operates in SPI control mode, it is possible to adjust the DOUTx strength, which can be selected in the DOUT_DRIVE_STR bits, as described in Table 42.

Table 42. DOUTx Strength

DOUT_DRIVE_STR	Mode
00	Nominal
01	Strong
10	Weak
11	Extra strong

SPI

The SPI gives the user flexibility to read the conversion from the Σ - Δ ADC where the processor or microcontroller is the master.

When a new conversion is completed, the \overline{DRDY} signal is toggled to indicate that data can be accessed. When DRDY toggles, the internal channel counter is reset and the next SPI read originates from Channel 0 again. Conversely, after the last channel data is read, all successive reads before the next DRDY signal originate from Channel 7 (LSB).

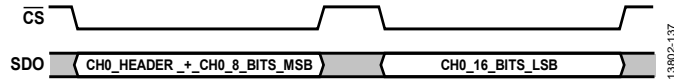

Figure 138. SPI Readback, 16 Bits per Frame

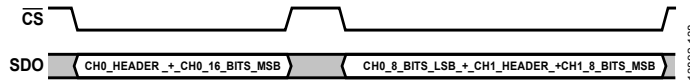

Figure 139. SPI Readback, 24 Bits per Frame

The SPI operates in multiples of 8 bits per frame; Figure 138 shows a readback example in 16 bits per frames, and Figure 139 shows a readback in 24 bits per frame.

Note that if the device is configured in SPI control mode, the AD7771 generates a software reset if the SDI pin is sampled high for 64 consecutive clocks. To avoid a reset or unwanted register writes, it is recommended to transfer a 0x8000 command, which generates a readback command that is ignored by the device, as explained in the SPI Software Reset section.

CALCULATING THE CRC CHECKSUM

The AD7771 implements two different CRC checksum generators, one for the Σ - Δ results and another for the SPI control mode.

The AD7771 uses a CRC polynomial to calculate the CRC checksum value. The 8-bit CRC polynomial used is $x^8 + x^2 + x + 1$.

The polynomial is aligned so that its MSB is adjacent to the leftmost Logic 1 of the data. An exclusive OR (XOR) function is applied to the data to produce a new, shorter number. The polynomial is again aligned so that its MSB is adjacent to the leftmost Logic 1 of the new result, and the procedure is repeated. This process is repeated until the original data is reduced to a value less than the polynomial. This is the 8-bit checksum.

An example of CRC calculation for 12-bit data is shown in Table 43.

Table 43. Example CRC Calculation for 12-Bit Data¹

Data	0	1	1	0	0	1	0	0	1	1	1	0
Polynomial		1	0	0	0	0	0	1	1			
			1	0	0	1	0	1	0	1	1	0
			1	0	0	0	0	0	1	1		
CRC					0	1	0	1	1	1	1	0

¹ This table represents the division of the data; blank cells are for formatting purposes.

Σ - Δ CRC Checksum

The CRC message is calculated internally by the AD7771 on ADC pairs. The CRC is calculated using the ADC output data from two ADCs and Bits[7:4] from the header. Therefore, 56 bits are used to calculate the 8-bit CRC. This CRC is split between the two channel headers. The CRC data covers channel pairings as follows: Channel 0 and Channel 1, Channel 2 and Channel 3, Channel 4 and Channel 5, and Channel 6 and Channel 7.

To generate the checksum, the data is left shifted by eight bits to create a number ending in eight Logic 1s.

The CRC is calculated from 56 bits across two consecutive/channel pairings (Channel 0 and Channel 1, Channel 2 and Channel 3, Channel 4 and Channel 5, Channel 6, and Channel 7). The 56 bits consist of the alert bit, the 3 bits for the first ADC pairing channel, and the 24 bits of data of each pairing channel. For example, for the second channel pairing, Channel 2 and Channel 3,

$$56 \text{ bits} = \text{alert bit} + 3 \text{ ADC channel bits (010)} + 24 \text{ data bits (Channel 2)} + \text{alert bit} + 3 \text{ ADC channel bits (011)} + 24 \text{ data bits (Channel 3)}$$

SPI Control Mode Checksum

The CRC message is calculated internally by the AD7771. The data transferred to the AD7771 uses the R/W bit, a 7-bit address, and 8 bits of data for the CRC calculation.

The CRC calculated and appended to the data that is shifted out uses a 0010 0000 header and 8 bits of data for the register readback, as well as the 0010 header and 12 bits of SAR conversion data for the SAR readback transfers.

REGISTER SUMMARY

Table 44. Register Summary

Reg.	Name	Bits	Bit 7	Bit 6	Bit 5	Bit 4	Bit 3	Bit 2	Bit 1	Bit 0	Reset	R/W		
0x000	CH0_CONFIG	[7:0]	CH0_GAIN		CH0_REF_MONITOR	CH0_RX	RESERVED				0x00	/W R		
0x001	CH1_CONFIG	[7:0]	CH1_GAIN		CH1_REF_MONITOR	CH1_RX	RESERVED				0x00	R/W		
0x002	CH2_CONFIG	[7:0]	CH2_GAIN		CH2_REF_MONITOR	CH2_RX	RESERVED				0x00	R/W		
0x003	CH3_CONFIG	[7:0]	CH3_GAIN		CH3_REF_MONITOR	CH3_RX	RESERVED				0x00	R/W		
0x004	CH4_CONFIG	[7:0]	CH4_GAIN		CH4_REF_MONITOR	CH4_RX	RESERVED				0x00	R/W		
0x005	CH5_CONFIG	[7:0]	CH5_GAIN		CH5_REF_MONITOR	CH5_RX	RESERVED				0x00	R/W		
0x006	CH6_CONFIG	[7:0]	CH6_GAIN		CH6_REF_MONITOR	CH6_RX	RESERVED				0x00	R/W		
0x007	CH7_CONFIG	[7:0]	CH7_GAIN		CH7_REF_MONITOR	CH7_RX	RESERVED				0x00	R/W		
0x008	CH_DISABLE	[7:0]	CH7_DISABLE	CH6_DISABLE	CH5_DISABLE	CH4_DISABLE	CH3_DISABLE	CH2_DISABLE	CH1_DISABLE	CH0_DISABLE	0x00	R/W		
0x009	CH0_SYNC_OFFSET	[7:0]	CH0_SYNC_OFFSET									0x00	R/W	
0x00A	CH1_SYNC_OFFSET	[7:0]	CH1_SYNC_OFFSET									0x00	R/W	
0x00B	CH2_SYNC_OFFSET	[7:0]	CH2_SYNC_OFFSET									0x00	R/W	
0x00C	CH3_SYNC_OFFSET	[7:0]	CH3_SYNC_OFFSET									0x00	R/W	
0x00D	CH4_SYNC_OFFSET	[7:0]	CH4_SYNC_OFFSET									0x00	R/W	
0x00E	CH5_SYNC_OFFSET	[7:0]	CH5_SYNC_OFFSET									0x00	R/W	
0x00F	CH6_SYNC_OFFSET	[7:0]	CH6_SYNC_OFFSET									0x00	R/W	
0x010	CH7_SYNC_OFFSET	[7:0]	CH7_SYNC_OFFSET									0x00	R/W	
0x011	GENERAL_USER_CONFIG_1	[7:0]	ALL_CH_DIS_MCLK_EN	POWER-MODE	PDB_VCM	PDB_REFOUT_BUF	PDB_SAR	PDB_RC_OSC	SOFT_RESET		0x24	R/W		
0x012	GENERAL_USER_CONFIG_2	[7:0]	RESERVED	FILTER_MODE	SAR_DIAG_MODE_EN	SDO_DRIVE_STR		DOUT_DRIVE_STR		SPI_SYNC	0x09	R/W		
0x013	GENERAL_USER_CONFIG_3	[7:0]	CONVST_DEGLITCH_DIS		RESERVED	SPI_SLAVE_MODE_EN	RESERVED			CLK_QUAL_DIS	0x80	R/W		
0x014	DOUT_FORMAT	[7:0]	DOUT_FORMAT		DOUT_HEADER_FORMAT	RESERVED	DCLK_CLK_DIV			RESERVED	0x20	R/W		
0x015	ADC_MUX_CONFIG	[7:0]	REF_MUX_CTRL		MTR_MUX_CTRL				RESERVED		0x00	R/W		
0x016	GLOBAL_MUX_CONFIG	[7:0]	GLOBAL_MUX_CTRL					RESERVED					0x00	R/W
0x017	GPIO_CONFIG	[7:0]	RESERVED					GPIO_OP_EN					0x00	R/W
0x018	GPIO_DATA	[7:0]	RESERVED		GPIO_READ_DATA			GPIO_WRITE_DATA				0x00	R/W	
0x019	BUFFER_CONFIG_1	[7:0]	RESERVED			REF_BUF_POS_EN	REF_BUF_NEG_EN	RESERVED				0x38	R/W	
0x01A	BUFFER_CONFIG_2	[7:0]	REF-BUFP_PREQ	REF-BUFN_PREQ	RESERVED			PDB_ALDO1_OVRDRV	PDB_ALDO2_OVRDRV	PDB_DLDO_OVRDRV	0xC0	R/W		
0x01C	CH0_OFFSET_UPPER_BYTE	[7:0]	CH0_OFFSET_ALL[23:16]									0x00	R/W	
0x01D	CH0_OFFSET_MID_BYTE	[7:0]	CH0_OFFSET_ALL[15:8]									0x00	R/W	

Reg.	Name	Bits	Bit 7	Bit 6	Bit 5	Bit 4	Bit 3	Bit 2	Bit 1	Bit 0	Reset	R/W
0x01E	CH0_OFFSET_LOWER_BYTE	[7:0]				CH0_OFFSET_ALL[7:0]					0x00	R/W
0x01F	CH0_GAIN_UPPER_BYTE	[7:0]				CH0_GAIN_ALL[23:16]					0x00	R/W
0x020	CH0_GAIN_MID_BYTE	[7:0]				CH0_GAIN_ALL[15:8]					0x00	R/W
0x021	CH0_GAIN_LOWER_BYTE	[7:0]				CH0_GAIN_ALL[7:0]					0x00	R/W
0x022	CH1_OFFSET_UPPER_BYTE	[7:0]				CH1_OFFSET_ALL[23:16]					0x00	R/W
0x023	CH1_OFFSET_MID_BYTE	[7:0]				CH1_OFFSET_ALL[15:8]					0x00	R/W
0x024	CH1_OFFSET_LOWER_BYTE	[7:0]				CH1_OFFSET_ALL[7:0]					0x00	R/W
0x025	CH1_GAIN_UPPER_BYTE	[7:0]				CH1_GAIN_ALL[23:16]					0x00	R/W
0x026	CH1_GAIN_MID_BYTE	[7:0]				CH1_GAIN_ALL[15:8]					0x00	R/W
0x027	CH1_GAIN_LOWER_BYTE	[7:0]				CH1_GAIN_ALL[7:0]					0x00	R/W
0x028	CH2_OFFSET_UPPER_BYTE	[7:0]				CH2_OFFSET_ALL[23:16]					0x00	R/W
0x029	CH2_OFFSET_MID_BYTE	[7:0]				CH2_OFFSET_ALL[15:8]					0x00	R/W
0x02A	CH2_OFFSET_LOWER_BYTE	[7:0]				CH2_OFFSET_ALL[7:0]					0x00	R/W
0x02B	CH2_GAIN_UPPER_BYTE	[7:0]				CH2_GAIN_ALL[23:16]					0x00	R/W
0x02C	CH2_GAIN_MID_BYTE	[7:0]				CH2_GAIN_ALL[15:8]					0x00	R/W
0x02D	CH2_GAIN_LOWER_BYTE	[7:0]				CH2_GAIN_ALL[7:0]					0x00	R/W
0x02E	CH3_OFFSET_UPPER_BYTE	[7:0]				CH3_OFFSET_ALL[23:16]					0x00	R/W
0x02F	CH3_OFFSET_MID_BYTE	[7:0]				CH3_OFFSET_ALL[15:8]					0x00	R/W
0x030	CH3_OFFSET_LOWER_BYTE	[7:0]				CH3_OFFSET_ALL[7:0]					0x00	R/W
0x031	CH3_GAIN_UPPER_BYTE	[7:0]				CH3_GAIN_ALL[23:16]					0x00	R/W
0x032	CH3_GAIN_MID_BYTE	[7:0]				CH3_GAIN_ALL[15:8]					0x00	R/W
0x033	CH3_GAIN_LOWER_BYTE	[7:0]				CH3_GAIN_ALL[7:0]					0x00	R/W
0x034	CH4_OFFSET_UPPER_BYTE	[7:0]				CH4_OFFSET_ALL[23:16]					0x00	R/W
0x035	CH4_OFFSET_MID_BYTE	[7:0]				CH4_OFFSET_ALL[15:8]					0x00	R/W
0x036	CH4_OFFSET_LOWER_BYTE	[7:0]				CH4_OFFSET_ALL[7:0]					0x00	R/W
0x037	CH4_GAIN_UPPER_BYTE	[7:0]				CH4_GAIN_ALL[23:16]					0x00	R/W
0x038	CH4_GAIN_MID_BYTE	[7:0]				CH4_GAIN_ALL[15:8]					0x00	R/W
0x039	CH4_GAIN_LOWER_BYTE	[7:0]				CH4_GAIN_ALL[7:0]					0x00	R/W
0x03A	CH5_OFFSET_UPPER_BYTE	[7:0]				CH5_OFFSET_ALL[23:16]					0x00	R/W
0x03B	CH5_OFFSET_MID_BYTE	[7:0]				CH5_OFFSET_ALL[15:8]					0x00	R/W
0x03C	CH5_OFFSET_LOWER_BYTE	[7:0]				CH5_OFFSET_ALL[7:0]					0x00	R/W
0x03D	CH5_GAIN_UPPER_BYTE	[7:0]				CH5_GAIN_ALL[23:16]					0x00	R/W
0x03E	CH5_GAIN_MID_BYTE	[7:0]				CH5_GAIN_ALL[15:8]					0x00	R/W

Reg.	Name	Bits	Bit 7	Bit 6	Bit 5	Bit 4	Bit 3	Bit 2	Bit 1	Bit 0	Reset	R/W	
0x03F	CH5_GAIN_LOWER_BYTE	[7:0]	CH5_GAIN_ALL[7:0]								0x00	R/W	
0x040	CH6_OFFSET_UPPER_BYTE	[7:0]	CH6_OFFSET_ALL[23:16]								0x00	R/W	
0x041	CH6_OFFSET_MID_BYTE	[7:0]	CH6_OFFSET_ALL[15:8]								0x00	R/W	
0x042	CH6_OFFSET_LOWER_BYTE	[7:0]	CH6_OFFSET_ALL[7:0]								0x00	R/W	
0x043	CH6_GAIN_UPPER_BYTE	[7:0]	CH6_GAIN_ALL[23:16]								0x00	R/W	
0x044	CH6_GAIN_MID_BYTE	[7:0]	CH6_GAIN_ALL[15:8]								0x00	R/W	
0x045	CH6_GAIN_LOWER_BYTE	[7:0]	CH6_GAIN_ALL[7:0]								0x00	R/W	
0x046	CH7_OFFSET_UPPER_BYTE	[7:0]	CH7_OFFSET_ALL[23:16]								0x00	R/W	
0x047	CH7_OFFSET_MID_BYTE	[7:0]	CH7_OFFSET_ALL[15:8]								0x00	R/W	
0x048	CH7_OFFSET_LOWER_BYTE	[7:0]	CH7_OFFSET_ALL[7:0]								0x00	R/W	
0x049	CH7_GAIN_UPPER_BYTE	[7:0]	CH7_GAIN_ALL[23:16]								0x00	R/W	
0x04A	CH7_GAIN_MID_BYTE	[7:0]	CH7_GAIN_ALL[15:8]								0x00	R/W	
0x04B	CH7_GAIN_LOWER_BYTE	[7:0]	CH7_GAIN_ALL[7:0]								0x00	R/W	
0x04C	CH0_ERR_REG	[7:0]	RESERVED			CH0_ERR_AINM_UV	CH0_ERR_AINM_OV	CH0_ERR_AINP_UV	CH0_ERR_AINP_OV	CH0_ERR_REF_DET	0x00	R	
0x04D	CH1_ERR_REG	[7:0]	RESERVED			CH1_ERR_AINM_UV	CH1_ERR_AINM_OV	CH1_ERR_AINP_UV	CH1_ERR_AINP_OV	CH1_ERR_REF_DET	0x00	R	
0x04E	CH2_ERR_REG	[7:0]	RESERVED			CH2_ERR_AINM_UV	CH2_ERR_AINM_OV	CH2_ERR_AINP_UV	CH2_ERR_AINP_OV	CH2_ERR_REF_DET	0x00	R	
0x04F	CH3_ERR_REG	[7:0]	RESERVED			CH3_ERR_AINM_UV	CH3_ERR_AINM_OV	CH3_ERR_AINP_UV	CH3_ERR_AINP_OV	CH3_ERR_REF_DET	0x00	R	
0x050	CH4_ERR_REG	[7:0]	RESERVED			CH4_ERR_AINM_UV	CH4_ERR_AINM_OV	CH4_ERR_AINP_UV	CH4_ERR_AINP_OV	CH4_ERR_REF_DET	0x00	R	
0x051	CH5_ERR_REG	[7:0]	RESERVED			CH5_ERR_AINM_UV	CH5_ERR_AINM_OV	CH5_ERR_AINP_UV	CH5_ERR_AINP_OV	CH5_ERR_REF_DET	0x00	R	
0x052	CH6_ERR_REG	[7:0]	RESERVED			CH6_ERR_AINM_UV	CH6_ERR_AINM_OV	CH6_ERR_AINP_UV	CH6_ERR_AINP_OV	CH6_ERR_REF_DET	0x00	R	
0x053	CH7_ERR_REG	[7:0]	RESERVED			CH7_ERR_AINM_UV	CH7_ERR_AINM_OV	CH7_ERR_AINP_UV	CH7_ERR_AINP_OV	CH7_ERR_REF_DET	0x00	R	
0x054	CH0_1_SAT_ERR	[7:0]	RESERVED		CH1_ERR_MOD_SAT	CH1_ERR_FILTER_SAT	CH1_ERR_OUTPUT_SAT	CH0_ERR_MOD_SAT	CH0_ERR_FILTER_SAT	CH0_ERR_OUTPUT_SAT	0x00	R	
0x055	CH2_3_SAT_ERR	[7:0]	RESERVED		CH3_ERR_MOD_SAT	CH3_ERR_FILTER_SAT	CH3_ERR_OUTPUT_SAT	CH2_ERR_MOD_SAT	CH2_ERR_FILTER_SAT	CH2_ERR_OUTPUT_SAT	0x00	R	
0x056	CH4_5_SAT_ERR	[7:0]	RESERVED		CH5_ERR_MOD_SAT	CH5_ERR_FILTER_SAT	CH5_ERR_OUTPUT_SAT	CH4_ERR_MOD_SAT	CH4_ERR_FILTER_SAT	CH4_ERR_OUTPUT_SAT	0x00	R	
0x057	CH6_7_SAT_ERR	[7:0]	RESERVED		CH7_ERR_MOD_SAT	CH7_ERR_FILTER_SAT	CH7_ERR_OUTPUT_SAT	CH6_ERR_MOD_SAT	CH6_ERR_FILTER_SAT	CH6_ERR_OUTPUT_SAT	0x00	R	
0x058	CHX_ERR_REG_EN	[7:0]	OUTPUT_SAT_TEST_EN	FILTER_SAT_TEST_EN	MOD_SAT_TEST_EN	AINM_UV_TEST_EN	AINM_OV_TEST_EN	AINP_UV_TEST_EN	AINP_OV_TEST_EN	REF_DET_TEST_EN	0xFE	R/W	
0x059	GEN_ERR_REG_1	[7:0]	RESERVED			MEMMAP_CRC_ERR	ROM_CRC_ERR	SPI_CLK_COUNT_ERR	SPI_INVALID_READ_ERR	SPI_INVALID_WRITE_ERR	SPI_CRC_ERR	0x00	R
0x05A	GEN_ERR_REG_1_EN	[7:0]	RESERVED			MEMMAP_CRC_TEST_EN	ROM_CRC_TEST_EN	SPI_CLK_COUNT_TEST_EN	SPI_INVALID_READ_TEST_EN	SPI_INVALID_WRITE_TEST_EN	SPI_CRC_TEST_EN	0x3E	R/W
0x05B	GEN_ERR_REG_2	[7:0]	RESERVED			RESET_DETECTED	EXT_MCLK_SWITCH_ERR	RESERVED	ALDO1_PSM_ERR	ALDO2_PSM_ERR	DLDO_PSM_ERR	0x00	R
0x05C	GEN_ERR_REG_2_EN	[7:0]	RESERVED			RESET_DETECT_EN	RESERVED	LDO_PSM_TEST_EN	LDO_PSM_TRIP_TEST_EN		0x3C	R/W	

Reg.	Name	Bits	Bit 7	Bit 6	Bit 5	Bit 4	Bit 3	Bit 2	Bit 1	Bit 0	Reset	R/W	
0x05D	STATUS_REG_1	[7:0]	RESERVED		CHIP_ERROR	ERR_LOC_CH4	ERR_LOC_CH3	ERR_LOC_CH2	ERR_LOC_CH1	ERR_LOC_C H0	0x00	R	
0x05E	STATUS_REG_2	[7:0]	RESERVED		CHIP_ERROR	ERR_LOC_GEN2	ERR_LOC_GEN1	ERR_LOC_CH7	ERR_LOC_CH6	ERR_LOC_C H5	0x00	R	
0x05F	STATUS_REG_3	[7:0]	RESERVED		CHIP_ERROR	INIT_COMPLETE	ERR_LOC_SAT_CH6_7	ERR_LOC_SAT_CH4_5	ERR_LOC_SAT_CH2_3	ERR_LOC_SAT_CH0_1	0x00	R	
0x060	SRC_N_MSB	[7:0]	RESERVED				SRC_N_ALL[11:8]					0x00	R/W
0x061	SRC_N_LSB	[7:0]	SRC_N_ALL[7:0]									0x80	R/W
0x062	SRC_IF_MSB	[7:0]	SRC_IF_ALL[15:8]									0x00	R/W
0x063	SRC_IF_LSB	[7:0]	SRC_IF_ALL[7:0]									0x00	R/W
0x064	SRC_UPDATE	[7:0]	SRC_LOAD_SOURCE	RESERVED						SRC_LOAD_UPDATE	0x00	R/W	

REGISTER DETAILS

CHANNEL 0 CONFIGURATION REGISTER

Address: 0x000, Reset: 0x00, Name: CH0_CONFIG

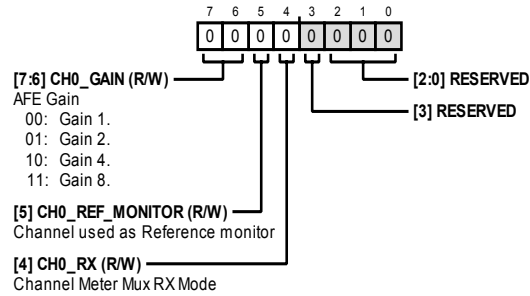

Table 45. Bit Descriptions for CH0_CONFIG

Bits	Bit Name	Settings	Description	Reset	Access
[7:6]	CH0_GAIN	00 01 10 11	AFE Gain Gain = 1 Gain = 2 Gain = 4 Gain = 8	0x0	R/W
5	CH0_REF_MONITOR		Channel Used as Reference Monitor	0x0	R/W
4	CH0_RX		Channel Meter Mux Rx Mode	0x0	R/W
[3:0]	RESERVED		Reserved	0x0	R/W

CHANNEL 1 CONFIGURATION REGISTER

Address: 0x001, Reset: 0x00, Name: CH1_CONFIG

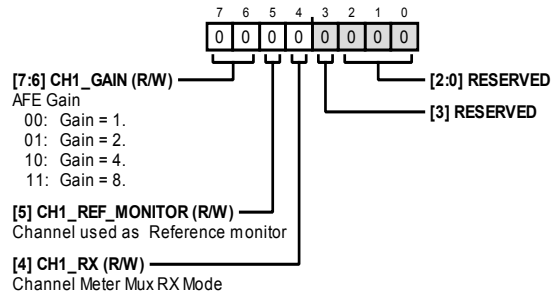

Table 46. Bit Descriptions for CH1_CONFIG

Bits	Bit Name	Settings	Description	Reset	Access
[7:6]	CH1_GAIN	00 01 10 11	AFE Gain Gain = 1 Gain = 2 Gain = 4 Gain = 8	0x0	R/W
5	CH1_REF_MONITOR		Channel Used as Reference Monitor	0x0	R/W
4	CH1_RX		Channel Meter Mux Rx Mode	0x0	R/W
[3:0]	RESERVED		Reserved	0x0	R/W

CHANNEL 2 CONFIGURATION REGISTER

Address: 0x002, Reset: 0x00, Name: CH2_CONFIG

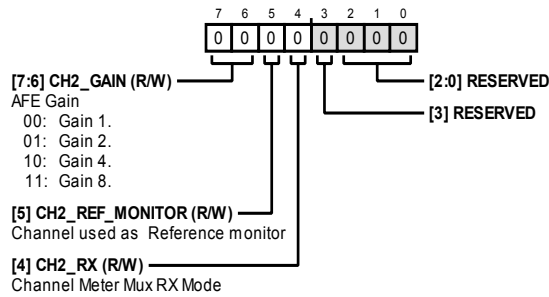

Table 47. Bit Descriptions for CH2_CONFIG

Bits	Bit Name	Settings	Description	Reset	Access
[7:6]	CH2_GAIN	00 01 10 11	AFE Gain Gain = 1 Gain = 2 Gain = 4 Gain = 8	0x0	R/W
5	CH2_REF_MONITOR		Channel Used as Reference Monitor	0x0	R/W
4	CH2_RX		Channel Meter Mux Rx Mode	0x0	R/W
[3:0]	RESERVED		Reserved	0x0	R/W

CHANNEL 3 CONFIGURATION REGISTER

Address: 0x003, Reset: 0x00, Name: CH3_CONFIG

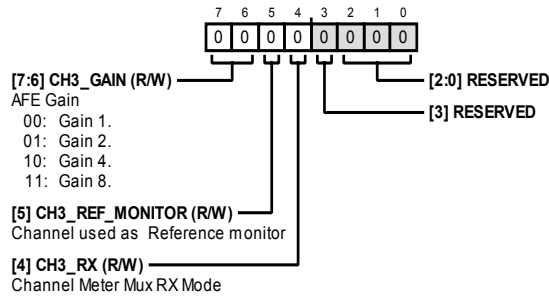

Table 48. Bit Descriptions for CH3_CONFIG

Bits	Bit Name	Settings	Description	Reset	Access
[7:6]	CH3_GAIN	00 01 10 11	AFE Gain Gain = 1 Gain = 2 Gain = 4 Gain = 8	0x0	R/W
5	CH3_REF_MONITOR		Channel Used as Reference Monitor	0x0	R/W
4	CH3_RX		Channel Meter Mux Rx Mode	0x0	R/W
[3:0]	RESERVED		Reserved	0x0	R/W

CHANNEL 4 CONFIGURATION REGISTER

Address: 0x004, Reset: 0x00, Name: CH4_CONFIG

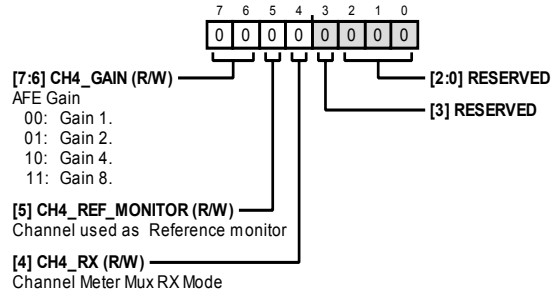

Table 49. Bit Descriptions for CH4_CONFIG

Bits	Bit Name	Settings	Description	Reset	Access
[7:6]	CH4_GAIN	00 01 10 11	AFE Gain Gain = 1 Gain = 2 Gain = 4 Gain = 8	0x0	R/W
5	CH4_REF_MONITOR		Channel Used as Reference Monitor	0x0	R/W
4	CH4_RX		Channel Meter Mux Rx Mode	0x0	R/W
[3:0]	RESERVED		Reserved	0x0	R/W

CHANNEL 5 CONFIGURATION REGISTER

Address: 0x005, Reset: 0x00, Name: CH5_CONFIG

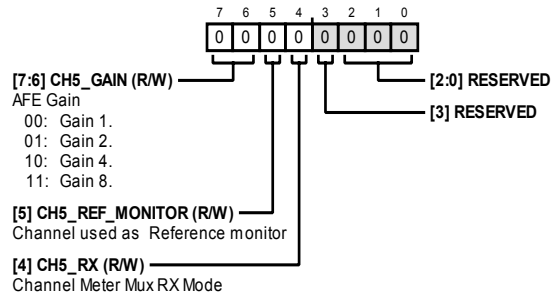

Table 50. Bit Descriptions for CH5_CONFIG

Bits	Bit Name	Settings	Description	Reset	Access
[7:6]	CH5_GAIN	00 01 10 11	AFE Gain Gain = 1 Gain = 2 Gain = 4 Gain = 8	0x0	R/W
5	CH5_REF_MONITOR		Channel Used as Reference Monitor	0x0	R/W
4	CH5_RX		Channel Meter Mux Rx Mode	0x0	R/W
[3:0]	RESERVED		Reserved	0x0	R/W

CHANNEL 6 CONFIGURATION REGISTER

Address: 0x006, Reset: 0x00, Name: CH6_CONFIG

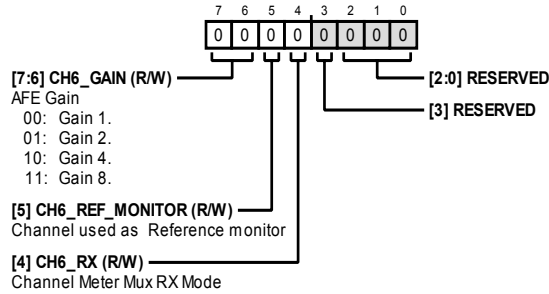

Table 51. Bit Descriptions for CH6_CONFIG

Bits	Bit Name	Settings	Description	Reset	Access
[7:6]	CH6_GAIN	00 01 10 11	AFE Gain Gain = 1 Gain = 2 Gain = 4 Gain = 8	0x0	R/W
5	CH6_REF_MONITOR		Channel Used as Reference Monitor	0x0	R/W
4	CH6_RX		Channel Meter Mux Rx Mode	0x0	R/W
[3:0]	RESERVED		Reserved	0x0	R/W

CHANNEL 7 CONFIGURATION REGISTER

Address: 0x007, Reset: 0x00, Name: CH7_CONFIG

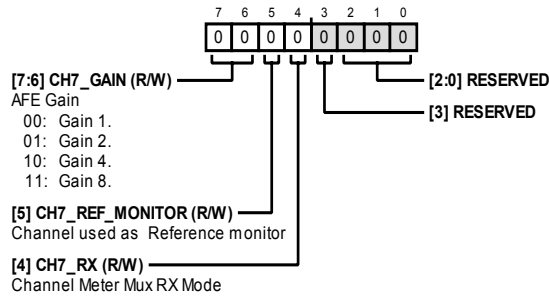

Table 52. Bit Descriptions for CH7_CONFIG

Bits	Bit Name	Settings	Description	Reset	Access
[7:6]	CH7_GAIN	00 01 10 11	AFE Gain Gain = 1 Gain = 2 Gain = 4 Gain = 8	0x0	R/W
5	CH7_REF_MONITOR		Channel Used as Reference Monitor	0x0	R/W
4	CH7_RX		Channel Meter Mux Rx Mode	0x0	R/W
[3:0]	RESERVED		Reserved	0x0	R/W

DISABLE CLOCKS TO ADC CHANNEL REGISTER

Address: 0x008, Reset: 0x00, Name: CH_DISABLE

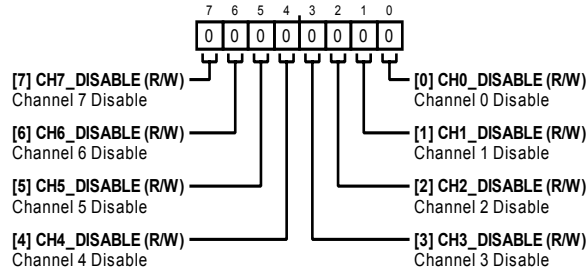

Table 53. Bit Descriptions for CH_DISABLE

Bits	Bit Name	Settings	Description	Reset	Access
7	CH7_DISABLE		Channel 7 Disable	0x0	R/W
6	CH6_DISABLE		Channel 6 Disable	0x0	R/W
5	CH5_DISABLE		Channel 5 Disable	0x0	R/W
4	CH4_DISABLE		Channel 4 Disable	0x0	R/W
3	CH3_DISABLE		Channel 3 Disable	0x0	R/W
2	CH2_DISABLE		Channel 2 Disable	0x0	R/W
1	CH1_DISABLE		Channel 1 Disable	0x0	R/W
0	CH0_DISABLE		Channel 0 Disable	0x0	R/W

CHANNEL 0 SYNC OFFSET REGISTER

Address: 0x009, Reset: 0x00, Name: CH0_SYNC_OFFSET

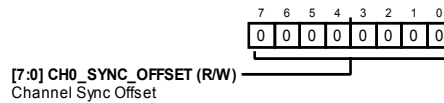

Table 54. Bit Descriptions for CH0_SYNC_OFFSET

Bits	Bit Name	Settings	Description	Reset	Access
[7:0]	CH0_SYNC_OFFSET		Channel Sync Offset	0x0	R/W

CHANNEL 1 SYNC OFFSET REGISTER

Address: 0x00A, Reset: 0x00, Name: CH1_SYNC_OFFSET

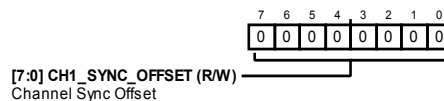

Table 55. Bit Descriptions for CH1_SYNC_OFFSET

Bits	Bit Name	Settings	Description	Reset	Access
[7:0]	CH1_SYNC_OFFSET		Channel Sync Offset	0x0	R/W

CHANNEL 2 SYNC OFFSET REGISTER

Address: 0x00B, Reset: 0x00, Name: CH2_SYNC_OFFSET

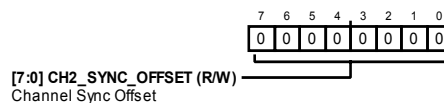

Table 56. Bit Descriptions for CH2_SYNC_OFFSET

Bits	Bit Name	Settings	Description	Reset	Access
[7:0]	CH2_SYNC_OFFSET		Channel Sync Offset	0x0	R/W

CHANNEL 3 SYNC OFFSET REGISTER

Address: 0x00C, Reset: 0x00, Name: CH3_SYNC_OFFSET

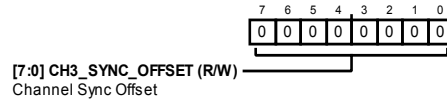

Table 57. Bit Descriptions for CH3_SYNC_OFFSET

Bits	Bit Name	Settings	Description	Reset	Access
[7:0]	CH3_SYNC_OFFSET		Channel Sync Offset	0x0	R/W

CHANNEL 4 SYNC OFFSET REGISTER

Address: 0x00D, Reset: 0x00, Name: CH4_SYNC_OFFSET

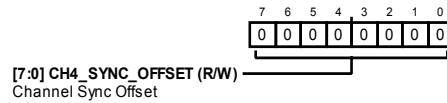

Table 58. Bit Descriptions for CH4_SYNC_OFFSET

Bits	Bit Name	Settings	Description	Reset	Access
[7:0]	CH4_SYNC_OFFSET		Channel Sync Offset	0x0	R/W

CHANNEL 5 SYNC OFFSET REGISTER

Address: 0x00E, Reset: 0x00, Name: CH5_SYNC_OFFSET

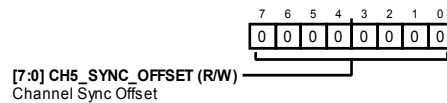

Table 59. Bit Descriptions for CH5_SYNC_OFFSET

Bits	Bit Name	Settings	Description	Reset	Access
[7:0]	CH5_SYNC_OFFSET		Channel Sync Offset	0x0	R/W

CHANNEL 6 SYNC OFFSET REGISTER

Address: 0x00F, Reset: 0x00, Name: CH6_SYNC_OFFSET

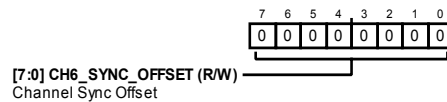

Table 60. Bit Descriptions for CH6_SYNC_OFFSET

Bits	Bit Name	Settings	Description	Reset	Access
[7:0]	CH6_SYNC_OFFSET		Channel Sync Offset	0x0	R/W

CHANNEL 7 SYNC OFFSET REGISTER

Address: 0x010, Reset: 0x00, Name: CH7_SYNC_OFFSET

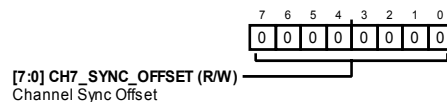
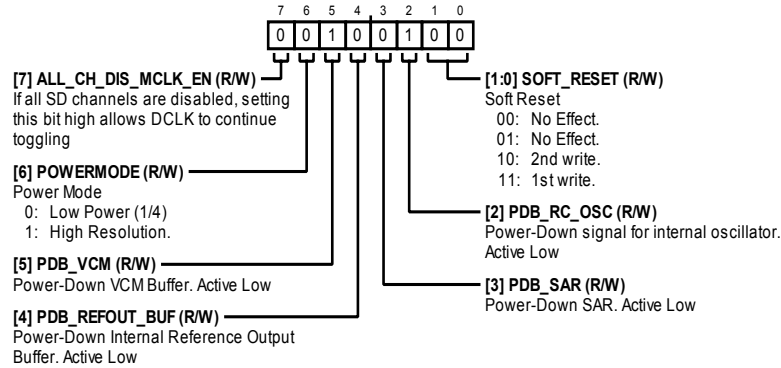

Table 61. Bit Descriptions for CH7_SYNC_OFFSET

Bits	Bit Name	Settings	Description	Reset	Access
[7:0]	CH7_SYNC_OFFSET		Channel Sync Offset	0x0	R/W

GENERAL USER CONFIGURATION 1 REGISTER

Address: 0x011, Reset: 0x24, Name: GENERAL_USER_CONFIG_1

**Table 62. Bit Descriptions for GENERAL_USER_CONFIG_1**

Bits	Bit Name	Settings	Description	Reset	Access
7	ALL_CH_DIS_MCLK_EN		If all Σ - Δ channels are disabled, setting this bit high allows DCLK to continue toggling.	0x0	R/W
6	POWERMODE	0 1	Power Mode. Low power (1/4). High resolution.	0x0	R/W
5	PDB_VCM		Power-Down VCM Buffer. Active low.	0x1	R/W
4	PDB_REFOUT_BUF		Power-Down Internal Reference Output Buffer. Active low.	0x0	R/W
3	PDB_SAR		Power-Down SAR. Active low.	0x0	R/W
2	PDB_RC_OSC		Power-Down Signal for Internal Oscillator. Active low.	0x1	R/W
[1:0]	SOFT_RESET	00 01 10 11	Soft Reset No effect No effect 2nd write 1st write	0x0	R/W

GENERAL USER CONFIGURATION 2 REGISTER

Address: 0x012, Reset: 0x09, Name: GENERAL_USER_CONFIG_2

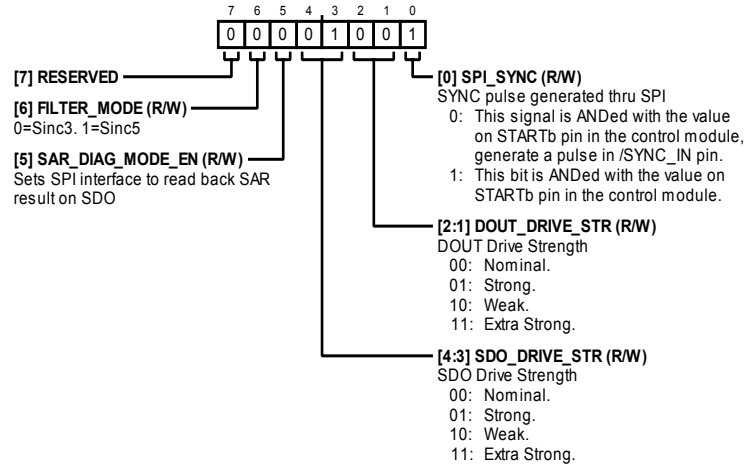

Table 63. Bit Descriptions for GENERAL_USER_CONFIG_2

Bits	Bit Name	Settings	Description	Reset	Access
7	RESERVED		Reserved.	0x0	R/W
6	FILTER_MODE		0 = Sinc3. 1 = Sinc5.	0x0	R/W
5	SAR_DIAG_MODE_EN		Sets SPI interface to read back SAR result on SDO.	0x0	R/W
[4:3]	SDO_DRIVE_STR	00 01 10 11	SDO Drive Strength. Nominal. Strong. Weak. Extra Strong.	0x1	R/W
[2:1]	DOUT_DRIVE_STR	00 01 10 11	DOUTx Drive Strength. Nominal. Strong. Weak. Extra Strong.	0x0	R/W
0	SPI_SYNC	0 1	Sync pulse generated through SPI. This signal is AND'ed with the value on <u>START</u> pin in the control module to generate a pulse in <u>SYNC_IN</u> pin. This bit is AND'ed with the value on <u>START</u> pin in the control module.	0x1	R/W

GENERAL USER CONFIGURATION 3 REGISTER

Address: 0x013, Reset: 0x80, Name: GENERAL_USER_CONFIG_3

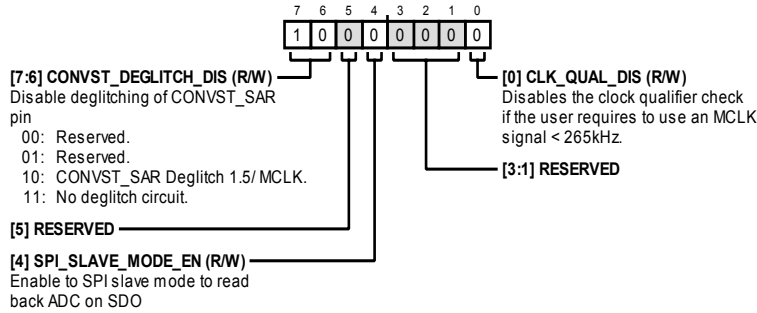

Table 64. Bit Descriptions for GENERAL_USER_CONFIG_3

Bits	Bit Name	Settings	Description	Reset	Access
[7:6]	CONVST_DEGLITCH_DIS	00 01 10 11	Disable deglitching of CONVST_SAR pin. Reserved. Reserved. CONVST_SAR deglitch 1.5/MCLK. No deglitch circuit.	0x2	R/W
5	RESERVED		Reserved.	0x0	R/W
4	SPI_SLAVE_MODE_EN		Enable to SPI slave mode to read back ADC on SDO.	0x0	R/W
[3:2]	RESERVED		Reserved.	0x0	R/W
1	RESERVED		Reserved.	0x0	R/W
0	CLK_QUAL_DIS		Disables the clock qualifier check if the user requires to use an MCLK signal <265 kHz.	0x0	R/W

DATA OUTPUT FORMAT REGISTER

Address: 0x014, Reset: 0x20, Name: DOUT_FORMAT

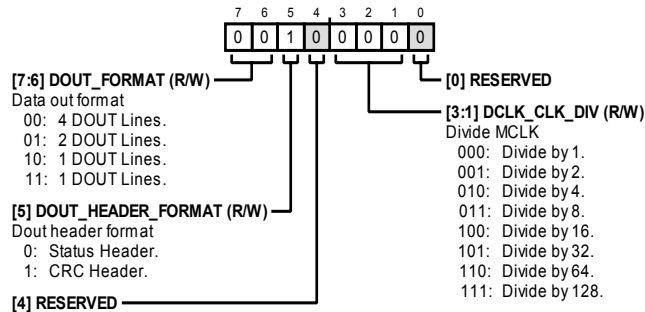

Table 65. Bit Descriptions for DOUT_FORMAT

Bits	Bit Name	Settings	Description	Reset	Access
[7:6]	DOUT_FORMAT	00 01 10 11	Data Out Format 4 DOUTx lines 2 DOUTx lines 1 DOUTx lines 1 DOUTx line	0x0	R/W
5	DOUT_HEADER_FORMAT	0 1	DOUTx Header Format Status header CRC header	0x1	R/W
4	RESERVED		Reserved	0x0	R/W

Bits	Bit Name	Settings	Description	Reset	Access
[3:1]	DCLK_CLK_DIV	000 001 010 011 100 101 110 111	Divide MCLK Divide by 1 Divide by 2 Divide by 4 Divide by 8 Divide by 16 Divide by 32 Divide by 64 Divide by 128	0x0	R/W
0	RESERVED		Reserved	0x0	R/W

MAIN ADC METER AND REFERENCE MUX CONTROL REGISTER

Address: 0x015, Reset: 0x00, Name: ADC_MUX_CONFIG

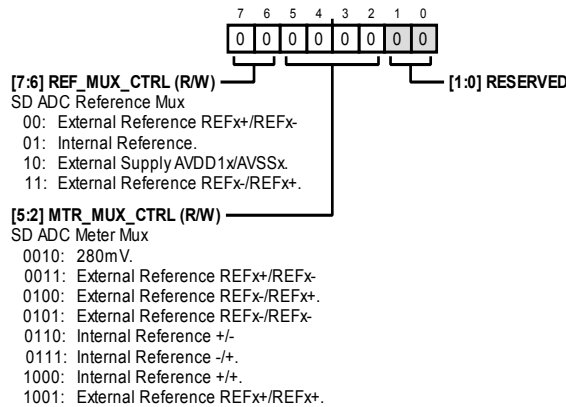

Table 66. Bit Descriptions for ADC_MUX_CONFIG

Bits	Bit Name	Settings	Description	Reset	Access
[7:6]	REF_MUX_CTRL	00 01 10 11	Σ - Δ ADC Reference Mux. External reference REFx+/REFx-. Internal reference. External supply AVDD1x/AVSSx. External reference REFx-/REFx+.	0x0	R/W
[5:2]	MTR_MUX_CTRL	0010 0011 0100 0101 0110 0111 1000 1001	Σ - Δ ADC Meter Mux. 280 mV. External reference REFx+/REFx-. External reference REFx-/REFx+. External reference REFx-/REFx-. Internal reference +/-. Internal reference -/+. Internal reference +/-. External reference REFx+/REFx+.	0x0	R/W
[1:0]	RESERVED		Reserved.	0x0	R/W

GLOBAL DIAGNOSTICS MUX REGISTER

Address: 0x016, Reset: 0x00, Name: GLOBAL_MUX_CONFIG

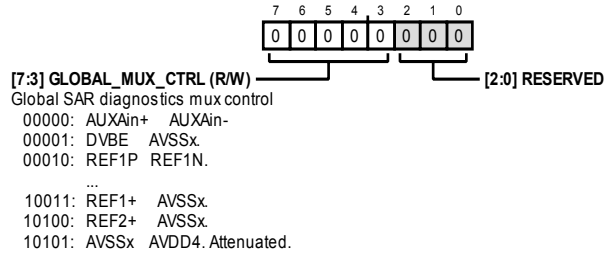

Table 67. Bit Descriptions for GLOBAL_MUX_CONFIG

Bits	Bit Name	Settings	Description	Reset	Access
[7:3]	GLOBAL_MUX_CTRL		Global SAR Diagnostics Mux Control.	0x0	R/W
		00000	AUXAIN+/AUXAIN-.		
		00001	DV _{BE} /AVSSx.		
		00010	REF1+/REF1-.		
		10011	REF2+/REF2-.		
		10100	REF_OUT/AVSSx.		
		10101	VCN/AVSSx.		
		10110	AREG1CAP/AVSSx.		
		10111	AREG2CAP/AVSSx.		
		11000	DREGCAP/DGND.		
		11001	AVDD1A/AVSSx.		
		11010	AVDD1B/AVSSx.		
		11011	AVDD2A/AVSSx.		
		11100	AVDD2B/AVSSx.		
		11101	IOVDD/DGND.		
		11110	AVDD4/AVSSx.		
		11111	DGND/AVSSx.		
		10000	DGND/AVSSx.		
		10001	DGND/AVSSx.		
		10010	AVDD4/AVSSx.		
		10011	REF1+/AVSSx.		
		10100	REF2+/AVSSx.		
		10101	AVSSx/AVDD4. Attenuated.		
[2:0]	RESERVED		Reserved.	0x0	R/W

GPIO CONFIGURATION REGISTER

Address: 0x017, Reset: 0x00, Name: GPIO_CONFIG

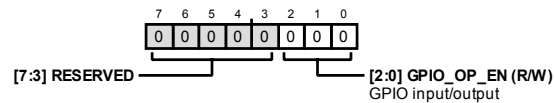

Table 68. Bit Descriptions for GPIO_CONFIG

Bits	Bit Name	Settings	Description	Reset	Access
[7:3]	RESERVED		Reserved.	0x0	R/W
[2:0]	GPIO_OP_EN		GPIO Input/Output	0x0	R/W

GPIO DATA REGISTER

Address: 0x018, Reset: 0x00, Name: GPIO_DATA

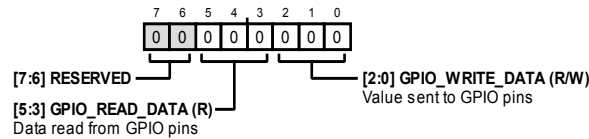

Table 69. Bit Descriptions for GPIO_DATA

Bits	Bit Name	Settings	Description	Reset	Access
[7:6]	RESERVED		Reserved.	0x0	R/W
[5:3]	GPIO_READ_DATA		Data Read from the GPIO Pins	0x0	R
[2:0]	GPIO_WRITE_DATA		Value Sent to the GPIO Pins	0x0	R/W

BUFFER CONFIGURATION 1 REGISTER

Address: 0x019, Reset: 0x38, Name: BUFFER_CONFIG_1

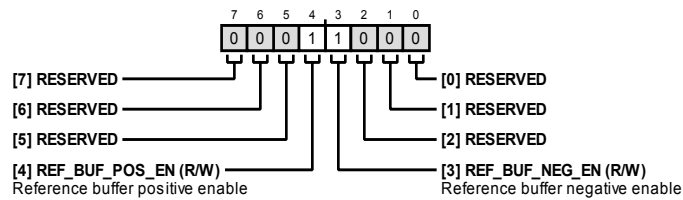

Table 70. Bit Descriptions for BUFFER_CONFIG_1

Bits	Bit Name	Settings	Description	Reset	Access
[7:5]	RESERVED		Reserved	0x0	R/W
4	REF_BUF_POS_EN		Reference Buffer Positive Enable	0x1	R/W
3	REF_BUF_NEG_EN		Reference Buffer Negative Enable	0x1	R/W
[2:0]	RESERVED		Reserved	0x0	R/W

BUFFER CONFIGURATION 2 REGISTER

Address: 0x01A, Reset: 0xC0, Name: BUFFER_CONFIG_2

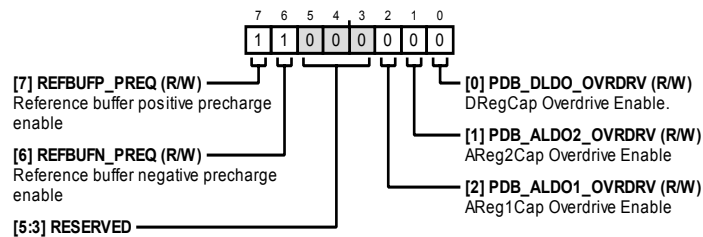

Table 71. Bit Descriptions for BUFFER_CONFIG_2

Bits	Bit Name	Settings	Description	Reset	Access
7	REFBUF_P_REQ		Reference Buffer Positive Precharge Enable	0x1	R/W
6	REFBUF_N_REQ		Reference Buffer Negative Precharge Enable	0x1	R/W
[5:3]	RESERVED		Reserved	0x0	R/W
2	PDB_ALDO1_OVRDRV		AREG1CAP Overdrive Enable	0x0	R/W
1	PDB_ALDO2_OVRDRV		AREG2CAP Overdrive Enable	0x0	R/W
0	PDB_DLDO_OVRDRV		DREGCAP Overdrive Enable	0x0	R/W

CHANNEL 0 OFFSET UPPER BYTE REGISTER

Address: 0x01C, Reset: 0x00, Name: CH0_OFFSET_UPPER_BYTE

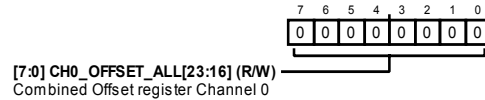

Table 72. Bit Descriptions for CH0_OFFSET_UPPER_BYTE

Bits	Bit Name	Settings	Description	Reset	Access
[7:0]	CH0_OFFSET_ALL[23:16]		Combined Offset Register Channel 0	0x0	R/W

CHANNEL 0 OFFSET MIDDLE BYTE REGISTER

Address: 0x01D, Reset: 0x00, Name: CH0_OFFSET_MID_BYTE

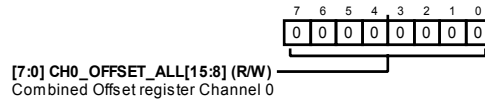

Table 73. Bit Descriptions for CH0_OFFSET_MID_BYTE

Bits	Bit Name	Settings	Description	Reset	Access
[7:0]	CH0_OFFSET_ALL[15:8]		Combined Offset Register Channel 0	0x0	R/W

CHANNEL 0 OFFSET LOWER BYTE REGISTER

Address: 0x01E, Reset: 0x00, Name: CH0_OFFSET_LOWER_BYTE

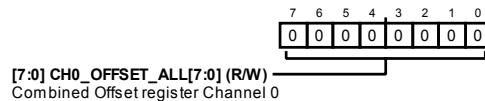

Table 74. Bit Descriptions for CH0_OFFSET_LOWER_BYTE

Bits	Bit Name	Settings	Description	Reset	Access
[7:0]	CH0_OFFSET_ALL[7:0]		Combined Offset Register Channel 0	0x0	R/W

CHANNEL 0 GAIN UPPER BYTE REGISTER

Address: 0x01F, Reset: 0x00, Name: CH0_GAIN_UPPER_BYTE

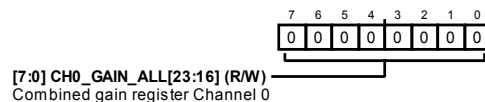

Table 75. Bit Descriptions for CH0_GAIN_UPPER_BYTE

Bits	Bit Name	Settings	Description	Reset	Access
[7:0]	CH0_GAIN_ALL[23:16]		Combined Gain Register Channel 0	0x0	R/W

CHANNEL 0 GAIN MIDDLE BYTE REGISTER

Address: 0x020, Reset: 0x00, Name: CH0_GAIN_MID_BYTE

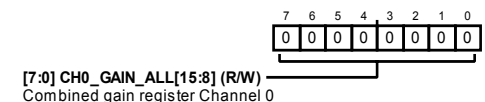

Table 76. Bit Descriptions for CH0_GAIN_MID_BYTE

Bits	Bit Name	Settings	Description	Reset	Access
[7:0]	CH0_GAIN_ALL[15:8]		Combined Gain Register Channel 0	0x0	R/W

CHANNEL 0 GAIN LOWER BYTE REGISTER

Address: 0x021, Reset: 0x00, Name: CH0_GAIN_LOWER_BYTE

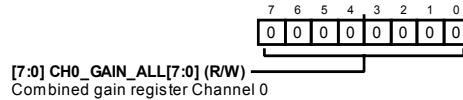

Table 77. Bit Descriptions for CH0_GAIN_LOWER_BYTE

Bits	Bit Name	Settings	Description	Reset	Access
[7:0]	CH0_GAIN_ALL[7:0]		Combined Gain Register Channel 0	0x0	R/W

CHANNEL 1 OFFSET UPPER BYTE REGISTER

Address: 0x022, Reset: 0x00, Name: CH1_OFFSET_UPPER_BYTE



Table 78. Bit Descriptions for CH1_OFFSET_UPPER_BYTE

Bits	Bit Name	Settings	Description	Reset	Access
[7:0]	CH1_OFFSET_ALL[23:16]		Combined Offset Register Channel 1	0x0	R/W

CHANNEL 1 OFFSET MIDDLE BYTE REGISTER

Address: 0x023, Reset: 0x00, Name: CH1_OFFSET_MID_BYTE

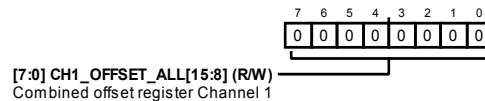

Table 79. Bit Descriptions for CH1_OFFSET_MID_BYTE

Bits	Bit Name	Settings	Description	Reset	Access
[7:0]	CH1_OFFSET_ALL[15:8]		Combined Offset Register Channel 1	0x0	R/W

CHANNEL 1 OFFSET LOWER BYTE REGISTER

Address: 0x024, Reset: 0x00, Name: CH1_OFFSET_LOWER_BYTE

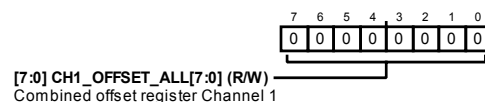

Table 80. Bit Descriptions for CH1_OFFSET_LOWER_BYTE

Bits	Bit Name	Settings	Description	Reset	Access
[7:0]	CH1_OFFSET_ALL[7:0]		Combined Offset Register Channel 1	0x0	R/W

CHANNEL 1 GAIN UPPER BYTE REGISTER

Address: 0x025, Reset: 0x00, Name: CH1_GAIN_UPPER_BYTE

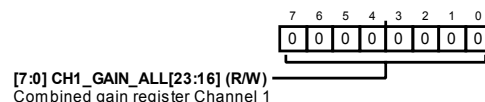

Table 81. Bit Descriptions for CH1_GAIN_UPPER_BYTE

Bits	Bit Name	Settings	Description	Reset	Access
[7:0]	CH1_GAIN_ALL[23:16]		Combined Gain Register Channel 1	0x0	R/W

CHANNEL 1 GAIN MIDDLE BYTE REGISTER

Address: 0x026, Reset: 0x00, Name: CH1_GAIN_MID_BYTE

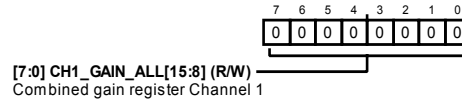

Table 82. Bit Descriptions for CH1_GAIN_MID_BYTE

Bits	Bit Name	Settings	Description	Reset	Access
[7:0]	CH1_GAIN_ALL[15:8]		Combined Gain Register Channel 1	0x0	R/W

CHANNEL 1 GAIN LOWER BYTE REGISTER

Address: 0x027, Reset: 0x00, Name: CH1_GAIN_LOWER_BYTE

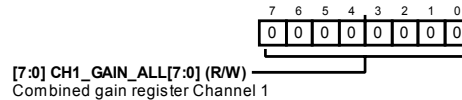

Table 83. Bit Descriptions for CH1_GAIN_LOWER_BYTE

Bits	Bit Name	Settings	Description	Reset	Access
[7:0]	CH1_GAIN_ALL[7:0]		Combined Gain Register Channel 1	0x0	R/W

CHANNEL 2 OFFSET UPPER BYTE REGISTER

Address: 0x028, Reset: 0x00, Name: CH2_OFFSET_UPPER_BYTE

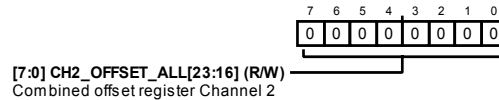

Table 84. Bit Descriptions for CH2_OFFSET_UPPER_BYTE

Bits	Bit Name	Settings	Description	Reset	Access
[7:0]	CH2_OFFSET_ALL[23:16]		Combined Offset Register Channel 2	0x0	R/W

CHANNEL 2 OFFSET MIDDLE BYTE REGISTER

Address: 0x029, Reset: 0x00, Name: CH2_OFFSET_MID_BYTE

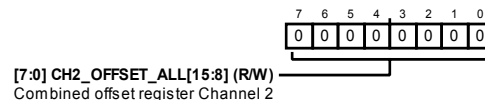

Table 85. Bit Descriptions for CH2_OFFSET_MID_BYTE

Bits	Bit Name	Settings	Description	Reset	Access
[7:0]	CH2_OFFSET_ALL[15:8]		Combined Offset Register Channel 2	0x0	R/W

CHANNEL 2 OFFSET LOWER BYTE REGISTER

Address: 0x02A, Reset: 0x00, Name: CH2_OFFSET_LOWER_BYTE

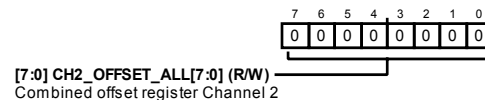

Table 86. Bit Descriptions for CH2_OFFSET_LOWER_BYTE

Bits	Bit Name	Settings	Description	Reset	Access
[7:0]	CH2_OFFSET_ALL[7:0]		Combined Offset Register Channel 2	0x0	R/W

CHANNEL 2 GAIN UPPER BYTE REGISTER

Address: 0x02B, Reset: 0x00, Name: CH2_GAIN_UPPER_BYTE

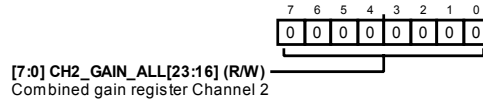

Table 87. Bit Descriptions for CH2_GAIN_UPPER_BYTE

Bits	Bit Name	Settings	Description	Reset	Access
[7:0]	CH2_GAIN_ALL[23:16]		Combined Gain Register Channel 2	0x0	R/W

CHANNEL 2 GAIN MIDDLE BYTE REGISTER

Address: 0x02C, Reset: 0x00, Name: CH2_GAIN_MID_BYTE

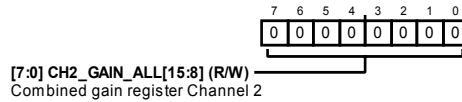

Table 88. Bit Descriptions for CH2_GAIN_MID_BYTE

Bits	Bit Name	Settings	Description	Reset	Access
[7:0]	CH2_GAIN_ALL[15:8]		Combined Gain Register Channel 2	0x0	R/W

CHANNEL 2 GAIN LOWER BYTE REGISTER

Address: 0x02D, Reset: 0x00, Name: CH2_GAIN_LOWER_BYTE

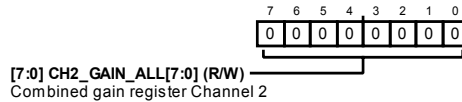

Table 89. Bit Descriptions for CH2_GAIN_LOWER_BYTE

Bits	Bit Name	Settings	Description	Reset	Access
[7:0]	CH2_GAIN_ALL[7:0]		Combined Gain Register Channel 2	0x0	R/W

CHANNEL 3 OFFSET UPPER BYTE REGISTER

Address: 0x02E, Reset: 0x00, Name: CH3_OFFSET_UPPER_BYTE



Table 90. Bit descriptions for CH3_OFFSET_UPPER_BYTE

Bits	Bit Name	Settings	Description	Reset	Access
[7:0]	CH3_OFFSET_ALL[23:16]		Combined Offset Register Channel 3	0x0	R/W

CHANNEL 3 OFFSET MIDDLE BYTE REGISTER

Address: 0x02F, Reset: 0x00, Name: CH3_OFFSET_MID_BYTE

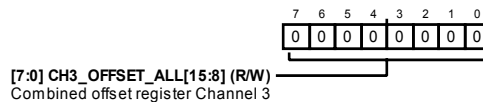

Table 91. Bit Descriptions for CH3_OFFSET_MID_BYTE

Bits	Bit Name	Settings	Description	Reset	Access
[7:0]	CH3_OFFSET_ALL[15:8]		Combined Offset Register Channel 3	0x0	R/W

CHANNEL 3 OFFSET LOWER BYTE REGISTER

Address: 0x030, Reset: 0x00, Name: CH3_OFFSET_LOWER_BYTE

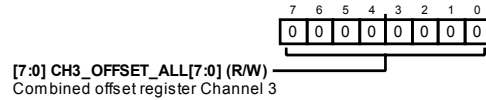

Table 92. Bit Descriptions for CH3_OFFSET_LOWER_BYTE

Bits	Bit Name	Settings	Description	Reset	Access
[7:0]	CH3_OFFSET_ALL[7:0]		Combined Offset Register Channel 3	0x0	R/W

CHANNEL 3 GAIN UPPER BYTE REGISTER

Address: 0x031, Reset: 0x00, Name: CH3_GAIN_UPPER_BYTE

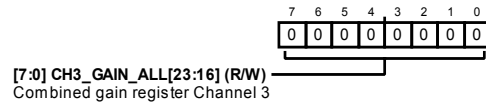

Table 93. Bit Descriptions for CH3_GAIN_UPPER_BYTE

Bits	Bit Name	Settings	Description	Reset	Access
[7:0]	CH3_GAIN_ALL[23:16]		Combined Gain Register Channel 3	0x0	R/W

CHANNEL 3 GAIN MIDDLE BYTE REGISTER

Address: 0x032, Reset: 0x00, Name: CH3_GAIN_MID_BYTE

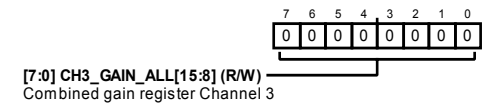

Table 94. Bit Descriptions for CH3_GAIN_MID_BYTE

Bits	Bit Name	Settings	Description	Reset	Access
[7:0]	CH3_GAIN_ALL[15:8]		Combined Gain Register Channel 3	0x0	R/W

CHANNEL 3 GAIN LOWER BYTE REGISTER

Address: 0x033, Reset: 0x00, Name: CH3_GAIN_LOWER_BYTE

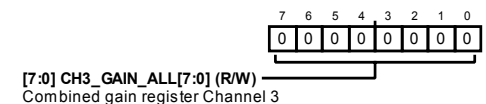

Table 95. Bit Descriptions for CH3_GAIN_LOWER_BYTE

Bits	Bit Name	Settings	Description	Reset	Access
[7:0]	CH3_GAIN_ALL[7:0]		Combined Gain Register Channel 3	0x0	R/W

CHANNEL 4 OFFSET UPPER BYTE REGISTER

Address: 0x034, Reset: 0x00, Name: CH4_OFFSET_UPPER_BYTE

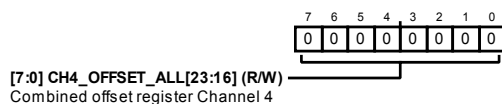

Table 96. Bit Descriptions for CH4_OFFSET_UPPER_BYTE

Bits	Bit Name	Settings	Description	Reset	Access
[7:0]	CH4_OFFSET_ALL[23:16]		Combined Offset Register Channel 4	0x0	R/W

CHANNEL 4 OFFSET MIDDLE BYTE REGISTER

Address: 0x035, Reset: 0x00, Name: CH4_OFFSET_MID_BYTE

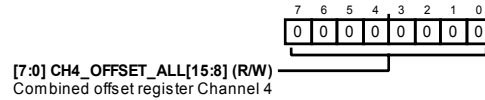

Table 97. Bit Descriptions for CH4_OFFSET_MID_BYTE

Bits	Bit Name	Settings	Description	Reset	Access
[7:0]	CH4_OFFSET_ALL[15:8]		Combined Offset Register Channel 4	0x0	R/W

CHANNEL 4 OFFSET LOWER BYTE REGISTER

Address: 0x036, Reset: 0x00, Name: CH4_OFFSET_LOWER_BYTE

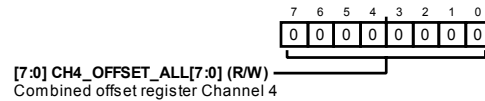

Table 98. Bit Descriptions for CH4_OFFSET_LOWER_BYTE

Bits	Bit Name	Settings	Description	Reset	Access
[7:0]	CH4_OFFSET_ALL[7:0]		Combined Offset Register Channel 4	0x0	R/W

CHANNEL 4 GAIN UPPER BYTE REGISTER

Address: 0x037, Reset: 0x00, Name: CH4_GAIN_UPPER_BYTE

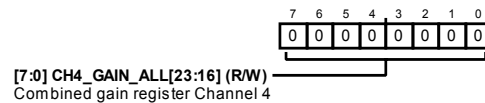

Table 99. Bit Descriptions for CH4_GAIN_UPPER_BYTE

Bits	Bit Name	Settings	Description	Reset	Access
[7:0]	CH4_GAIN_ALL[23:16]		Combined Gain Register Channel 4	0x0	R/W

CHANNEL 4 GAIN MIDDLE BYTE REGISTER

Address: 0x038, Reset: 0x00, Name: CH4_GAIN_MID_BYTE

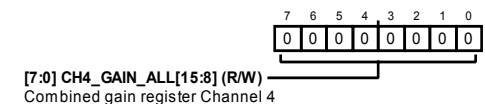

Table 100. Bit Descriptions for CH4_GAIN_MID_BYTE

Bits	Bit Name	Settings	Description	Reset	Access
[7:0]	CH4_GAIN_ALL[15:8]		Combined Gain Register Channel 4	0x0	R/W

CHANNEL 4 GAIN LOWER BYTE REGISTER

Address: 0x039, Reset: 0x00, Name: CH4_GAIN_LOWER_BYTE

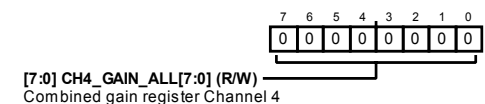

Table 101. Bit Descriptions for CH4_GAIN_LOWER_BYTE

Bits	Bit Name	Settings	Description	Reset	Access
[7:0]	CH4_GAIN_ALL[7:0]		Combined Gain Register Channel 4	0x0	R/W

CHANNEL 5 OFFSET UPPER BYTE REGISTER

Address: 0x03A, Reset: 0x00, Name: CH5_OFFSET_UPPER_BYTE

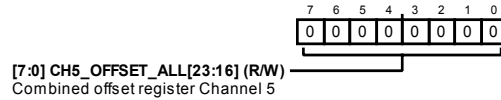

Table 102. Bit Descriptions for CH5_OFFSET_UPPER_BYTE

Bits	Bit Name	Settings	Description	Reset	Access
[7:0]	CH5_OFFSET_ALL[23:16]		Combined Offset Register Channel 5	0x0	R/W

CHANNEL 5 OFFSET MIDDLE BYTE REGISTER

Address: 0x03B, Reset: 0x00, Name: CH5_OFFSET_MID_BYTE

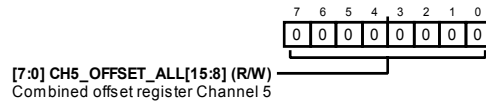

Table 103. Bit Descriptions for CH5_OFFSET_MID_BYTE

Bits	Bit Name	Settings	Description	Reset	Access
[7:0]	CH5_OFFSET_ALL[15:8]		Combined Offset Register Channel 5	0x0	R/W

CHANNEL 5 OFFSET LOWER BYTE REGISTER

Address: 0x03C, Reset: 0x00, Name: CH5_OFFSET_LOWER_BYTE

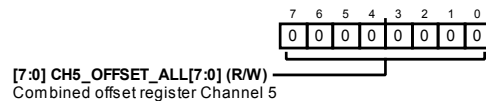

Table 104. Bit Descriptions for CH5_OFFSET_LOWER_BYTE

Bits	Bit Name	Settings	Description	Reset	Access
[7:0]	CH5_OFFSET_ALL[7:0]		Combined Offset Register Channel 5	0x0	R/W

CHANNEL 5 GAIN UPPER BYTE REGISTER

Address: 0x03D, Reset: 0x00, Name: CH5_GAIN_UPPER_BYTE

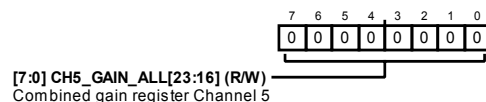

Table 105. Bit Descriptions for CH5_GAIN_UPPER_BYTE

Bits	Bit Name	Settings	Description	Reset	Access
[7:0]	CH5_GAIN_ALL[23:16]		Combined Gain Register Channel 5	0x0	R/W

CHANNEL 5 GAIN MIDDLE BYTE REGISTER

Address: 0x03E, Reset: 0x00, Name: CH5_GAIN_MID_BYTE

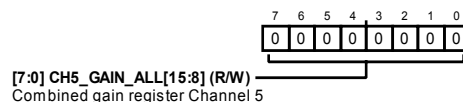

Table 106. Bit Descriptions for CH5_GAIN_MID_BYTE

Bits	Bit Name	Settings	Description	Reset	Access
[7:0]	CH5_GAIN_ALL[15:8]		Combined Gain Register Channel 5	0x0	R/W

CHANNEL 5 GAIN LOWER BYTE REGISTER

Address: 0x03F, Reset: 0x00, Name: CH5_GAIN_LOWER_BYTE

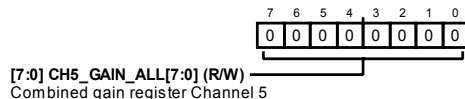

Table 107. Bit Descriptions for CH5_GAIN_LOWER_BYTE

Bits	Bit Name	Settings	Description	Reset	Access
[7:0]	CH5_GAIN_ALL[7:0]		Combined Gain Register Channel 5	0x0	R/W

CHANNEL 6 OFFSET UPPER BYTE REGISTER

Address: 0x040, Reset: 0x00, Name: CH6_OFFSET_UPPER_BYTE

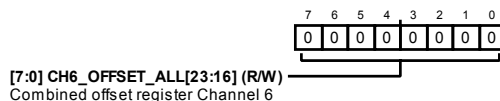

Table 108. Bit Descriptions for CH6_OFFSET_UPPER_BYTE

Bits	Bit Name	Settings	Description	Reset	Access
[7:0]	CH6_OFFSET_ALL[23:16]		Combined Offset Register Channel 6	0x0	R/W

CHANNEL 6 OFFSET MIDDLE BYTE REGISTER

Address: 0x041, Reset: 0x00, Name: CH6_OFFSET_MID_BYTE

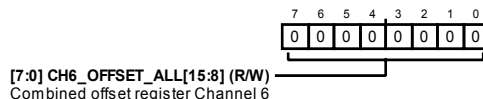

Table 109. Bit Descriptions for CH6_OFFSET_MID_BYTE

Bits	Bit Name	Settings	Description	Reset	Access
[7:0]	CH6_OFFSET_ALL[15:8]		Combined Offset Register Channel 6	0x0	R/W

CHANNEL 6 OFFSET LOWER BYTE REGISTER

Address: 0x042, Reset: 0x00, Name: CH6_OFFSET_LOWER_BYTE

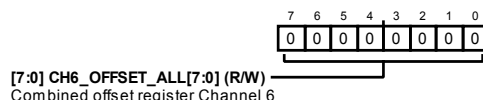

Table 110. Bit Descriptions for CH6_OFFSET_LOWER_BYTE

Bits	Bit Name	Settings	Description	Reset	Access
[7:0]	CH6_OFFSET_ALL[7:0]		Combined Offset Register Channel 6	0x0	R/W

CHANNEL 6 GAIN UPPER BYTE REGISTER

Address: 0x043, Reset: 0x00, Name: CH6_GAIN_UPPER_BYTE

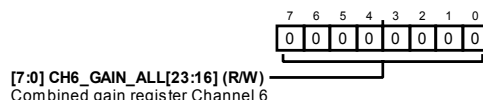

Table 111. Bit Descriptions for CH6_GAIN_UPPER_BYTE

Bits	Bit Name	Settings	Description	Reset	Access
[7:0]	CH6_GAIN_ALL[23:16]		Combined Gain Register Channel 6	0x0	R/W

CHANNEL 6 GAIN MIDDLE BYTE REGISTER

Address: 0x044, Reset: 0x00, Name: CH6_GAIN_MID_BYTE

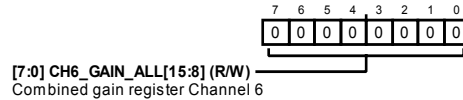

Table 112. Bit Descriptions for CH6_GAIN_MID_BYTE

Bits	Bit Name	Settings	Description	Reset	Access
[7:0]	CH6_GAIN_ALL[15:8]		Combined Gain Register Channel 6	0x0	R/W

CHANNEL 6 GAIN LOWER BYTE REGISTER

Address: 0x045, Reset: 0x00, Name: CH6_GAIN_LOWER_BYTE

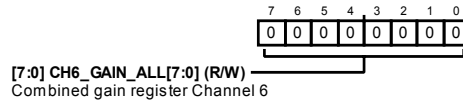

Table 113. Bit Descriptions for CH6_GAIN_LOWER_BYTE

Bits	Bit Name	Settings	Description	Reset	Access
[7:0]	CH6_GAIN_ALL[7:0]		Combined Gain Register Channel 6	0x0	R/W

CHANNEL 7 OFFSET UPPER BYTE REGISTER

Address: 0x046, Reset: 0x00, Name: CH7_OFFSET_UPPER_BYTE

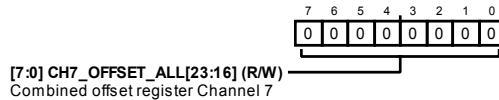

Table 114. Bit Descriptions for CH7_OFFSET_UPPER_BYTE

Bits	Bit Name	Settings	Description	Reset	Access
[7:0]	CH7_OFFSET_ALL[23:16]		Combined Offset Register Channel 7	0x0	R/W

CHANNEL 7 OFFSET MIDDLE BYTE REGISTER

Address: 0x047, Reset: 0x00, Name: CH7_OFFSET_MID_BYTE

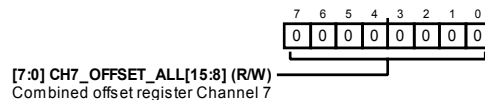

Table 115. Bit Descriptions for CH7_OFFSET_MID_BYTE

Bits	Bit Name	Settings	Description	Reset	Access
[7:0]	CH7_OFFSET_ALL[15:8]		Combined Offset Register Channel 7	0x0	R/W

CHANNEL 7 OFFSET LOWER BYTE REGISTER

Address: 0x048, Reset: 0x00, Name: CH7_OFFSET_LOWER_BYTE

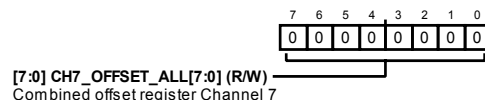

Table 116. Bit Descriptions for CH7_OFFSET_LOWER_BYTE

Bits	Bit Name	Settings	Description	Reset	Access
[7:0]	CH7_OFFSET_ALL[7:0]		Combined Offset Register Channel 7	0x0	R/W

CHANNEL 7 GAIN UPPER BYTE REGISTER

Address: 0x049, Reset: 0x00, Name: CH7_GAIN_UPPER_BYTE

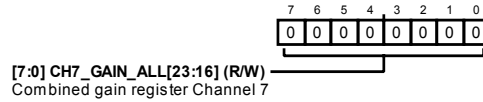

Table 117. Bit Descriptions for CH7_GAIN_UPPER_BYTE

Bits	Bit Name	Settings	Description	Reset	Access
[7:0]	CH7_GAIN_ALL[23:16]		Combined Gain Register Channel 7	0x0	R/W

CHANNEL 7 GAIN MIDDLE BYTE REGISTER

Address: 0x04A, Reset: 0x00, Name: CH7_GAIN_MID_BYTE

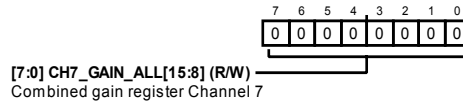

Table 118. Bit Descriptions for CH7_GAIN_MID_BYTE

Bits	Bit Name	Settings	Description	Reset	Access
[7:0]	CH7_GAIN_ALL[15:8]		Combined Gain Register Channel 7	0x0	R/W

CHANNEL 7 GAIN LOWER BYTE REGISTER

Address: 0x04B, Reset: 0x00, Name: CH7_GAIN_LOWER_BYTE

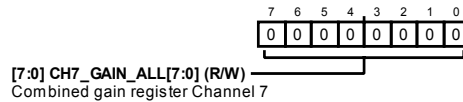

Table 119. Bit Descriptions for CH7_GAIN_LOWER_BYTE

Bits	Bit Name	Settings	Description	Reset	Access
[7:0]	CH7_GAIN_ALL[7:0]		Combined Gain Register Channel 7	0x0	R/W

CHANNEL 0 STATUS REGISTER

Address: 0x04C, Reset: 0x00, Name: CH0_ERR_REG

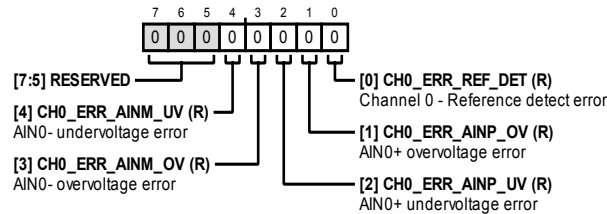

Table 120. Bit Descriptions for CH0_ERR_REG

Bits	Bit Name	Settings	Description	Reset	Access
[7:5]	RESERVED		Reserved	0x0	R/W
4	CH0_ERR_AINM_UV		Channel 0—AIN0– Undervoltage Error	0x0	R
3	CH0_ERR_AINM_OV		Channel 0—AIN0– Overvoltage Error	0x0	R
2	CH0_ERR_AINP_UV		Channel 0—AIN0+ Undervoltage Error	0x0	R
1	CH0_ERR_AINP_OV		Channel 0—AIN0+ Overvoltage Error	0x0	R
0	CH0_ERR_REF_DET		Channel 0—Reference Detect Error	0x0	R

CHANNEL 1 STATUS REGISTER

Address: 0x04D, Reset: 0x00, Name: CH1_ERR_REG

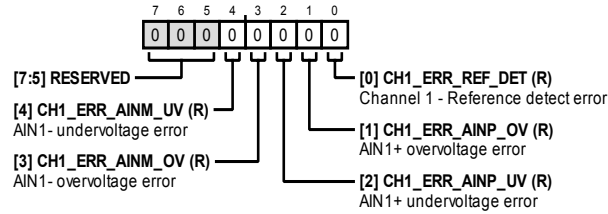

Table 121. Bit Descriptions for CH1_ERR_REG

Bits	Bit Name	Settings	Description	Reset	Access
[7:5]	RESERVED		Reserved	0x0	R/W
4	CH1_ERR_AINM_UV		Channel 1—AIN1– Undervoltage Error	0x0	R
3	CH1_ERR_AINM_OV		Channel 1—AIN1– Overvoltage Error	0x0	R
2	CH1_ERR_AINP_UV		Channel 1—AIN1+ Undervoltage Error	0x0	R
1	CH1_ERR_AINP_OV		Channel 1—AIN1+ Overvoltage Error	0x0	R
0	CH1_ERR_REF_DET		Channel 1—Reference Detect Error	0x0	R

CHANNEL 2 STATUS REGISTER

Address: 0x04E, Reset: 0x00, Name: CH2_ERR_REG

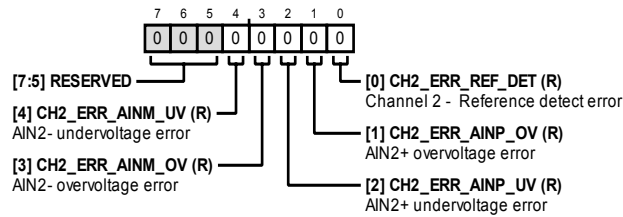

Table 122. Bit Descriptions for CH2_ERR_REG

Bits	Bit Name	Settings	Description	Reset	Access
[7:5]	RESERVED		Reserved	0x0	R/W
4	CH2_ERR_AINM_UV		Channel 2—AIN2– Undervoltage Error	0x0	R
3	CH2_ERR_AINM_OV		Channel 2—AIN2– Overvoltage Error	0x0	R
2	CH2_ERR_AINP_UV		Channel 2—AIN2+ Undervoltage Error	0x0	R
1	CH2_ERR_AINP_OV		Channel 2—AIN2+ Overvoltage Error	0x0	R
0	CH2_ERR_REF_DET		Channel 2—Reference Detect Error	0x0	R

CHANNEL 3 STATUS REGISTER

Address: 0x04F, Reset: 0x00, Name: CH3_ERR_REG

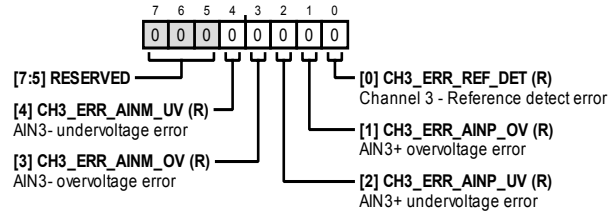

Table 123. Bit Descriptions for CH3_ERR_REG

Bits	Bit Name	Settings	Description	Reset	Access
[7:5]	RESERVED		Reserved	0x0	R/W
4	CH3_ERR_AINM_UV		Channel 3—AIN3– Undervoltage Error	0x0	R
3	CH3_ERR_AINM_OV		Channel 3—AIN3– Overvoltage Error	0x0	R
2	CH3_ERR_AINP_UV		Channel 3—AIN3+ Undervoltage Error	0x0	R
1	CH3_ERR_AINP_OV		Channel 3—AIN3+ Overvoltage Error	0x0	R
0	CH3_ERR_REF_DET		Channel 3—Reference Detect Error	0x0	R

CHANNEL 4 STATUS REGISTER

Address: 0x050, Reset: 0x00, Name: CH4_ERR_REG

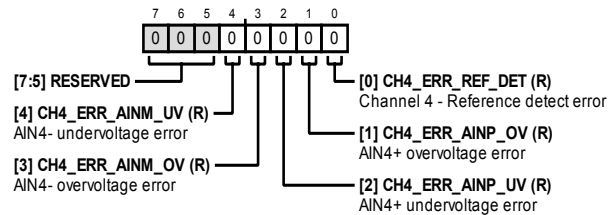

Table 124. Bit Descriptions for CH4_ERR_REG

Bits	Bit Name	Settings	Description	Reset	Access
[7:5]	RESERVED		Reserved	0x0	R/W
4	CH4_ERR_AINM_UV		Channel 4—AIN4– Undervoltage Error	0x0	R
3	CH4_ERR_AINM_OV		Channel 4—AIN4– Overvoltage Error	0x0	R
2	CH4_ERR_AINP_UV		Channel 4—AIN4+ Undervoltage Error	0x0	R
1	CH4_ERR_AINP_OV		Channel 4—AIN4+ Overvoltage Error	0x0	R
0	CH4_ERR_REF_DET		Channel 4—Reference Detect Error	0x0	R

CHANNEL 5 STATUS REGISTER

Address: 0x051, Reset: 0x00, Name: CH5_ERR_REG

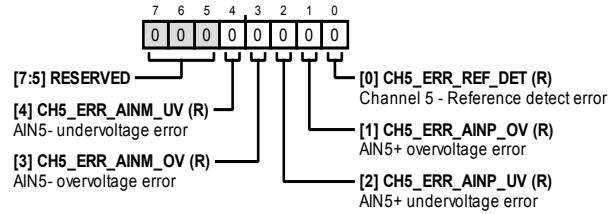

Table 125. Bit Descriptions for CH5_ERR_REG

Bits	Bit Name	Settings	Description	Reset	Access
[7:5]	RESERVED		Reserved	0x0	R/W
4	CH5_ERR_AINM_UV		Channel 5—AIN5– Undervoltage Error	0x0	R
3	CH5_ERR_AINM_OV		Channel 5—AIN5– Overvoltage Error	0x0	R
2	CH5_ERR_AINP_UV		Channel 5—AIN5+ Undervoltage Error	0x0	R
1	CH5_ERR_AINP_OV		Channel 5—AIN5+ Overvoltage Error	0x0	R
0	CH5_ERR_REF_DET		Channel 5—Reference Detect Error	0x0	R

CHANNEL 6 STATUS REGISTER

Address: 0x052, Reset: 0x00, Name: CH6_ERR_REG

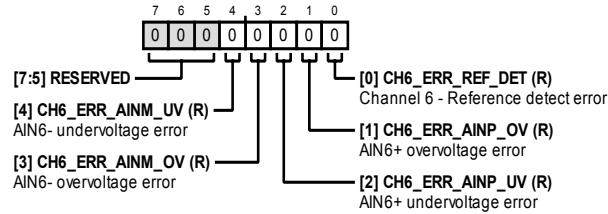

Table 126. Bit Descriptions for CH6_ERR_REG

Bits	Bit Name	Settings	Description	Reset	Access
[7:5]	RESERVED		Reserved	0x0	R/W
4	CH6_ERR_AINM_UV		Channel 6—AIN6– Undervoltage Error	0x0	R
3	CH6_ERR_AINM_OV		Channel 6—AIN6– Overvoltage Error	0x0	R
2	CH6_ERR_AINP_UV		Channel 6—AIN6+ Undervoltage Error	0x0	R
1	CH6_ERR_AINP_OV		Channel 6—AIN6+ Overvoltage Error	0x0	R
0	CH6_ERR_REF_DET		Channel 6—Reference Detect Error	0x0	R

CHANNEL 7 STATUS REGISTER

Address: 0x053, Reset: 0x00, Name: CH7_ERR_REG

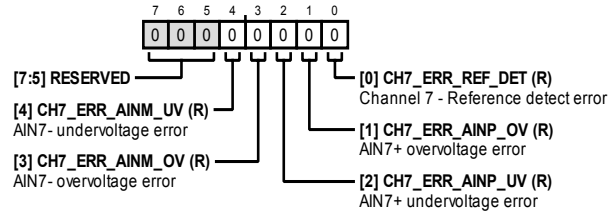

Table 127. Bit Descriptions for CH7_ERR_REG

Bits	Bit Name	Settings	Description	Reset	Access
[7:5]	RESERVED		Reserved	0x0	R
4	CH7_ERR_AINM_UV		Channel 7—AIN7– Undervoltage Error	0x0	R
3	CH7_ERR_AINM_OV		Channel 7—AIN7– Overvoltage Error	0x0	R
2	CH7_ERR_AINP_UV		Channel 7—AIN7+ Undervoltage Error	0x0	R
1	CH7_ERR_AINP_OV		Channel 7—AIN7+ Overvoltage Error	0x0	R
0	CH7_ERR_REF_DET		Channel 7—Reference Detect Error	0x0	R

CHANNEL 0/CHANNEL 1 DSP ERRORS REGISTER

Address: 0x054, Reset: 0x00, Name: CH0_1_SAT_ERR

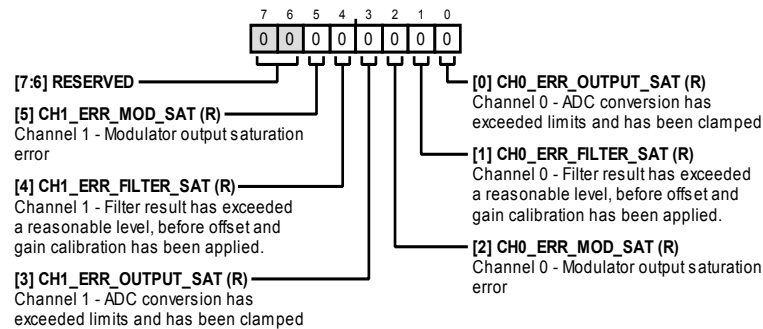

Table 128. Bit Descriptions for CH0_1_SAT_ERR

Bits	Bit Name	Settings	Description	Reset	Access
[7:6]	RESERVED		Reserved	0x0	R
5	CH1_ERR_MOD_SAT		Channel 1—Modulator output saturation error	0x0	R
4	CH1_ERR_FILTER_SAT		Channel 1—Filter result has exceeded a reasonable level, before offset and gain calibration are applied	0x0	R
3	CH1_ERR_OUTPUT_SAT		Channel 1—ADC conversion has exceeded limits and is clamped	0x0	R
2	CH0_ERR_MOD_SAT		Channel 0—Modulator output saturation error	0x0	R
1	CH0_ERR_FILTER_SAT		Channel 0—Filter result has exceeded a reasonable level, before offset and gain calibration are applied	0x0	R
0	CH0_ERR_OUTPUT_SAT		Channel 0—ADC conversion has exceeded limits and is clamped	0x0	R

CHANNEL 2/CHANNEL 3 DSP ERRORS REGISTER

Address: 0x055, Reset: 0x00, Name: CH2_3_SAT_ERR

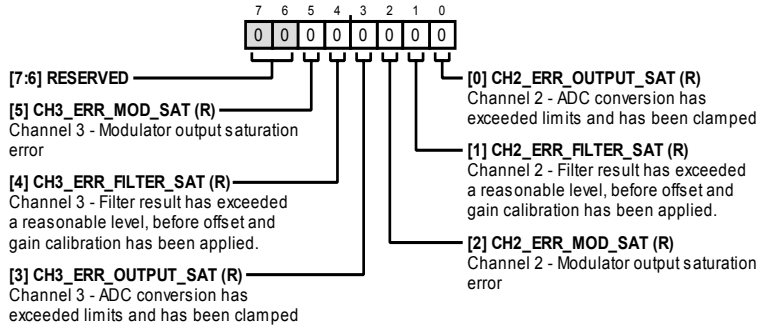

Table 129. Bit Descriptions for CH2_3_SAT_ERR

Bits	Bit Name	Settings	Description	Reset	Access
[7:6]	RESERVED		Reserved	0x0	R
5	CH3_ERR_MOD_SAT		Channel 3—Modulator output saturation error	0x0	R
4	CH3_ERR_FILTER_SAT		Channel 3—Filter result has exceeded a reasonable level, before offset and gain calibration are applied	0x0	R
3	CH3_ERR_OUTPUT_SAT		Channel 3—ADC conversion has exceeded limits and is clamped	0x0	R
2	CH2_ERR_MOD_SAT		Channel 2—Modulator output saturation error	0x0	R
1	CH2_ERR_FILTER_SAT		Channel 2—Filter result has exceeded a reasonable level, before offset and gain calibration are applied	0x0	R
0	CH2_ERR_OUTPUT_SAT		Channel 2—ADC conversion has exceeded limits and has been clamped	0x0	R

CHANNEL 4/CHANNEL 5 DSP ERRORS REGISTER

Address: 0x056, Reset: 0x00, Name: CH4_5_SAT_ERR

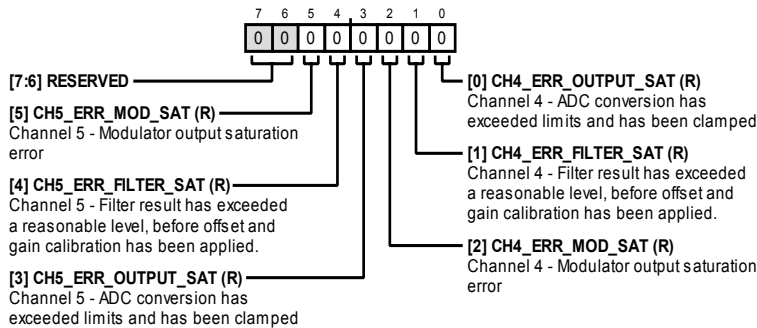

Table 130. Bit Descriptions for CH4_5_SAT_ERR

Bits	Bit Name	Settings	Description	Reset	Access
[7:6]	RESERVED		Reserved	0x0	R
5	CH5_ERR_MOD_SAT		Channel 5—Modulator output saturation error	0x0	R
4	CH5_ERR_FILTER_SAT		Channel 5—Filter result has exceeded a reasonable level, before offset and gain calibration are applied	0x0	R
3	CH5_ERR_OUTPUT_SAT		Channel 5—ADC conversion has exceeded limits and is clamped	0x0	R
2	CH4_ERR_MOD_SAT		Channel 4—Modulator output saturation error	0x0	R
1	CH4_ERR_FILTER_SAT		Channel 4—Filter result has exceeded a reasonable level, before offset and gain calibration are applied	0x0	R
0	CH4_ERR_OUTPUT_SAT		Channel 4—ADC conversion has exceeded limits and is clamped	0x0	R

CHANNEL 6/CHANNEL 7 DSP ERRORS REGISTER

Address: 0x057, Reset: 0x00, Name: CH6_7_SAT_ERR

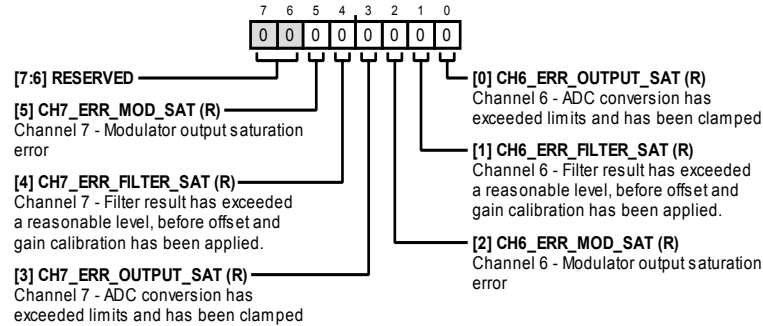

Table 131. Bit descriptions for CH6_7_SAT_ERR

Bits	Bit Name	Settings	Description	Reset	Access
[7:6]	RESERVED		Reserved	0x0	R
5	CH7_ERR_MOD_SAT		Channel 7—Modulator output saturation error	0x0	R
4	CH7_ERR_FILTER_SAT		Channel 7—Filter result has exceeded a reasonable level, before offset and gain calibration are applied	0x0	R
3	CH7_ERR_OUTPUT_SAT		Channel 7—ADC conversion has exceeded limits and is clamped	0x0	R
2	CH6_ERR_MOD_SAT		Channel 6—Modulator output saturation error	0x0	R
1	CH6_ERR_FILTER_SAT		Channel 6—Filter result has exceeded a reasonable level, before offset and gain calibration are applied	0x0	R
0	CH6_ERR_OUTPUT_SAT		Channel 6—ADC conversion has exceeded limits and is clamped	0x0	R

CHANNEL 0 TO CHANNEL 7 ERROR REGISTER ENABLE REGISTER

Address: 0x058, Reset: 0xFE, Name: CHX_ERR_REG_EN

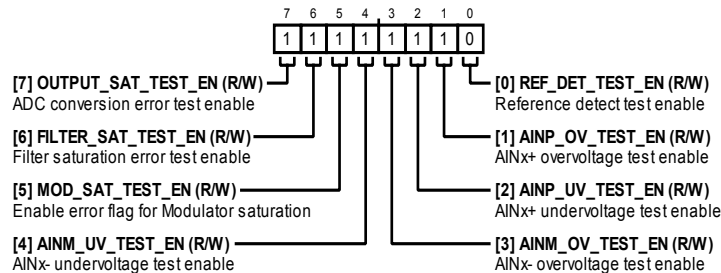

Table 132. Bit Descriptions for CHX_ERR_REG_EN

Bits	Bit Name	Settings	Description	Reset	Access
7	OUTPUT_SAT_TEST_EN		ADC Conversion Error Test Enable	0x1	R/W
6	FILTER_SAT_TEST_EN		Filter Saturation Test Enable	0x1	R/W
5	MOD_SAT_TEST_EN		Enable Error Flag for Modulator Saturation	0x1	R/W
4	AINM_UV_TEST_EN		AINx- Undervoltage Test Enable	0x1	R/W
3	AINM_OV_TEST_EN		AINx- Overvoltage Test Enable	0x1	R/W
2	AINP_UV_TEST_EN		AINx+ Undervoltage Test Enable	0x1	R/W
1	AINP_OV_TEST_EN		AINx+ Overvoltage Test Enable	0x1	R/W
0	REF_DET_TEST_EN		Reference Detect Test Enable	0x0	R/W

GENERAL ERRORS REGISTER 1

Address: 0x059, Reset: 0x00, Name: GEN_ERR_REG_1

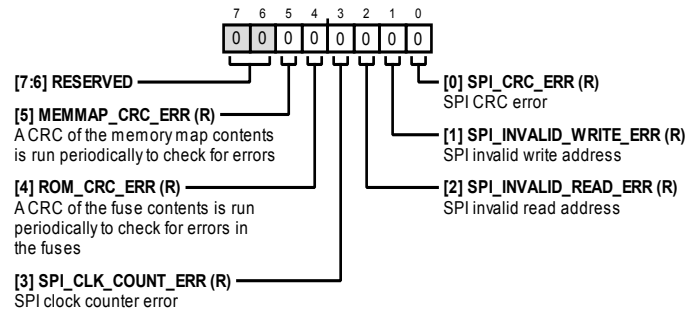

Table 133. Bit Descriptions for GEN_ERR_REG_1

Bits	Bit Name	Settings	Description	Reset	Access
[7:6]	RESERVED		Reserved	0x0	R
5	MEMMAP_CRC_ERR		A CRC of the memory map contents is run periodically to check for errors	0x0	R
4	ROM_CRC_ERR		A CRC of the fuse contents is run periodically to check for errors in the fuses	0x0	R
3	SPI_CLK_COUNT_ERR		SPI clock counter error	0x0	R
2	SPI_INVALID_READ_ERR		SPI invalid read address	0x0	R
1	SPI_INVALID_WRITE_ERR		SPI invalid write address	0x0	R
0	SPI_CRC_ERR		SPI CRC error	0x0	R

GENERAL ERRORS REGISTER 1 ENABLE

Address: 0x05A, Reset: 0x3E, Name: GEN_ERR_REG_1_EN

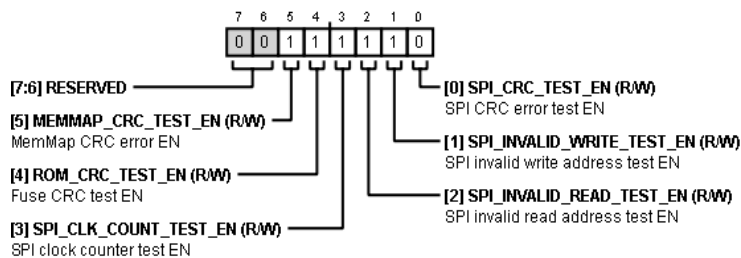

Table 134. Bit Descriptions for GEN_ERR_REG_1_EN

Bits	Bit Name	Settings	Description	Reset	Access
[7:6]	RESERVED		Reserved	0x0	R
5	MEMMAP_CRC_TEST_EN		Memory Map CRC Test Error Enable	0x1	R/W
4	ROM_CRC_TEST_EN		Fuse CRC Test Enable	0x1	R/W
3	SPI_CLK_COUNT_TEST_EN		SPI Clock Counter Test Enable	0x1	R/W
2	SPI_INVALID_READ_TEST_EN		SPI Invalid Read Address Test Enable	0x1	R/W
1	SPI_INVALID_WRITE_TEST_EN		SPI Invalid Write Address Test Enable	0x1	R/W
0	SPI_CRC_TEST_EN		SPI CRC Error Test Enable	0x0	R/W

GENERAL ERRORS REGISTER 2

Address: 0x05B, Reset: 0x00, Name: GEN_ERR_REG_2

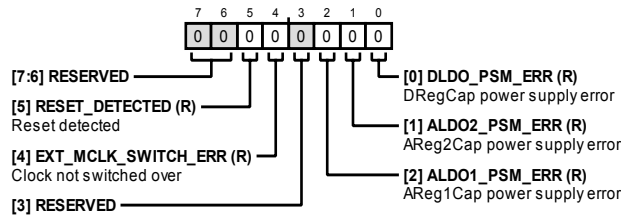

Table 135. Bit Descriptions for GEN_ERR_REG_2

Bits	Bit Name	Settings	Description	Reset	Access
[7:6]	RESERVED		Reserved	0x0	R
5	RESET_DETECTED		Reset Detected	0x0	R
4	EXT_MCLK_SWITCH_ERR		Clock Not Switched Over	0x0	R
3	RESERVED		Reserved	0x0	R
2	ALDO1_PSM_ERR		AREG1CAP Power Supply Error	0x0	R
1	ALDO2_PSM_ERR		AREG2CAP Power Supply Error	0x0	R
0	DLDO_PSM_ERR		DREGCAP Power Supply Error	0x0	R

GENERAL ERRORS REGISTER 2 ENABLE

Address: 0x05C, Reset: 0x3C, Name: GEN_ERR_REG_2_EN

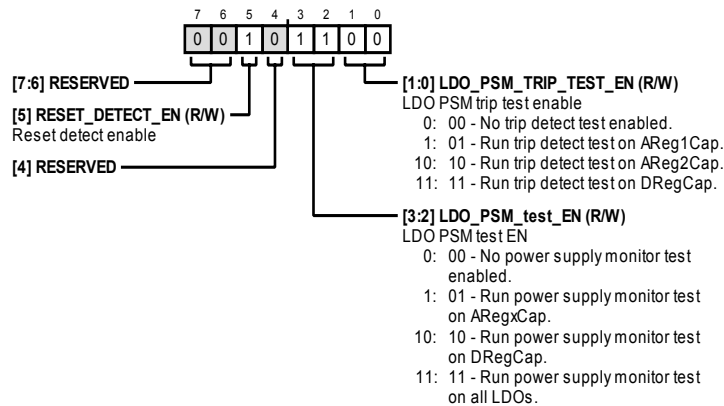

Table 136. Bit Descriptions for GEN_ERR_REG_2_EN

Bits	Bit Name	Settings	Description	Reset	Access
[7:6]	RESERVED		Reserved	0x0	R
5	RESET_DETECT_EN		Reset Detect Enable	0x1	R/W
4	RESERVED		Reserved	0x1	R/W
[3:2]	LDO_PSM_TEST_EN		LDO PSM Test Enable	0x3	R/W
		0	00—No power supply monitor test enabled		
		1	01—Run power supply monitor test on AREGxCAP		
		10	10—Run power supply monitor test on DREGCAP		
		11	11—Run power supply monitor test on all LDOs		
[1:0]	LDO_PSM_TRIP_TEST_EN		LDO PSM Trip Test Enable	0x0	R/W
		0	00—No trip detect test enabled		
		1	01—Run trip detect test on AREG1CAP		
		10	10—Run trip detect test on AREG2CAP		
		11	11—Run trip detect test on DREGCAP		

ERROR STATUS REGISTER 1

Address: 0x05D, Reset: 0x00, Name: STATUS_REG_1

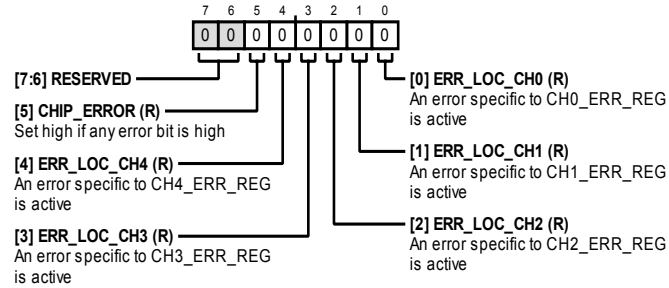

Table 137. Bit Descriptions for STATUS_REG_1

Bits	Bit Name	Settings	Description	Reset	Access
[7:6]	RESERVED		Reserved	0x0	R
5	CHIP_ERROR		Set this bit high if any error bit is high	0x0	R
4	ERR_LOC_CH4		An error specific to CH4_ERR_REG is active	0x0	R
3	ERR_LOC_CH3		An error specific to CH3_ERR_REG is active	0x0	R
2	ERR_LOC_CH2		An error specific to CH2_ERR_REG is active	0x0	R
1	ERR_LOC_CH1		An error specific to CH1_ERR_REG is active	0x0	R
0	ERR_LOC_CH0		An error specific to CH0_ERR_REG is active	0x0	R

ERROR STATUS REGISTER 2

Address: 0x05E, Reset: 0x00, Name: STATUS_REG_2

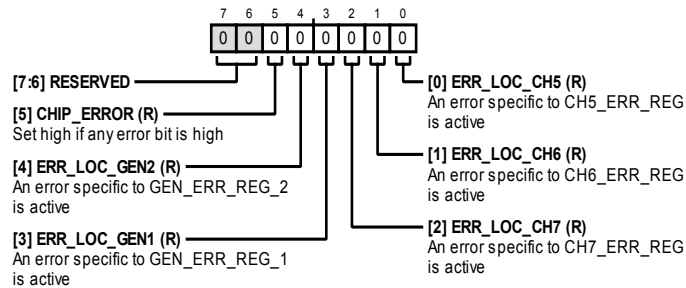

Table 138. Bit Descriptions for STATUS_REG_2

Bits	Bit Name	Settings	Description	Reset	Access
[7:6]	RESERVED		Reserved	0x0	R
5	CHIP_ERROR		Set high if any error bit is high	0x0	R
4	ERR_LOC_GEN2		An error specific to GEN_ERR_REG_2 is active	0x0	R
3	ERR_LOC_GEN1		An error specific to GEN_ERR_REG_1 is active	0x0	R
2	ERR_LOC_CH7		An error specific to CH7_ERR_REG is active	0x0	R
1	ERR_LOC_CH6		An error specific to CH6_ERR_REG is active	0x0	R
0	ERR_LOC_CH5		An error specific to CH5_ERR_REG is active	0x0	R

ERROR STATUS REGISTER 3

Address: 0x05F, Reset: 0x00, Name: STATUS_REG_3

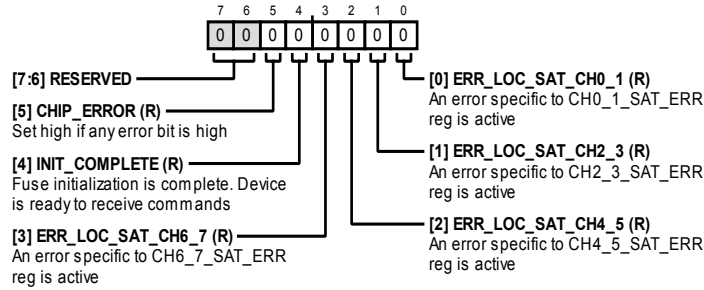

Table 139. Bit Descriptions for STATUS_REG_3

Bits	Bit Name	Settings	Description	Reset	Access
[7:6]	RESERVED		Reserved	0x0	R
5	CHIP_ERROR		Set high if any error bit is high.	0x0	R
4	INIT_COMPLETE		Fuse initialization is complete. Device is ready to receive commands.	0x0	R
3	ERR_LOC_SAT_CH6_7		An error specific to CH6_7_SAT_ERR register is active.	0x0	R
2	ERR_LOC_SAT_CH4_5		An error specific to CH4_5_SAT_ERR register is active.	0x0	R
1	ERR_LOC_SAT_CH2_3		An error specific to CH2_3_SAT_ERR register is active.	0x0	R
0	ERR_LOC_SAT_CH0_1		An error specific to CH0_1_SAT_ERR register is active.	0x0	R

DECIMATION RATE (N) MSB REGISTER

Address: 0x060, Reset: 0x00, Name: SRC_N_MSB

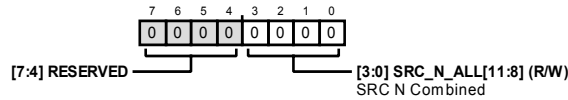

Table 140. Bit Descriptions for SRC_N_MSB

Bits	Bit Name	Settings	Description	Reset	Access
[7:4]	RESERVED		Reserved	0x0	R
[3:0]	SRC_N_ALL[11:8]		SRC N Combined	0x0	R/W

DECIMATION RATE (N) LSB REGISTER

Address: 0x061, Reset: 0x80, Name: SRC_N_LSB

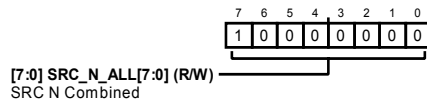

Table 141. Bit Descriptions for SRC_N_LSB

Bits	Bit Name	Settings	Description	Reset	Access
[7:0]	SRC_N_ALL[7:0]		SRC N Combined	0x0	R/W

DECIMATION RATE (IF) MSB REGISTER

Address: 0x062, Reset: 0x00, Name: SRC_IF_MSB

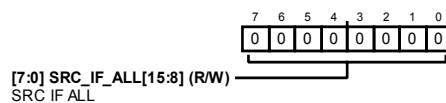

Table 142. Bit Descriptions for SRC_IF_MSB

Bits	Bit Name	Settings	Description	Reset	Access
[7:0]	SRC_IF_ALL[15:8]		SRC IF All	0x0	R/W

DECIMATION RATE (IF) LSB REGISTER

Address: 0x063, Reset: 0x00, Name: SRC_IF_LSB

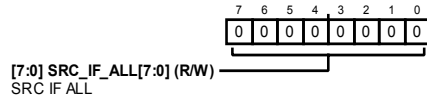

Table 143. Bit Descriptions for SRC_IF_LSB

Bits	Bit Name	Settings	Description	Reset	Access
[7:0]	SRC_IF_ALL[7:0]		SRC IF All	0x0	R/W

SRC LOAD SOURCE AND LOAD UPDATE REGISTER

Address: 0x064, Reset: 0x00, Name: SRC_UPDATE

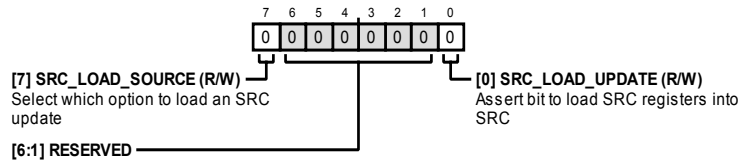
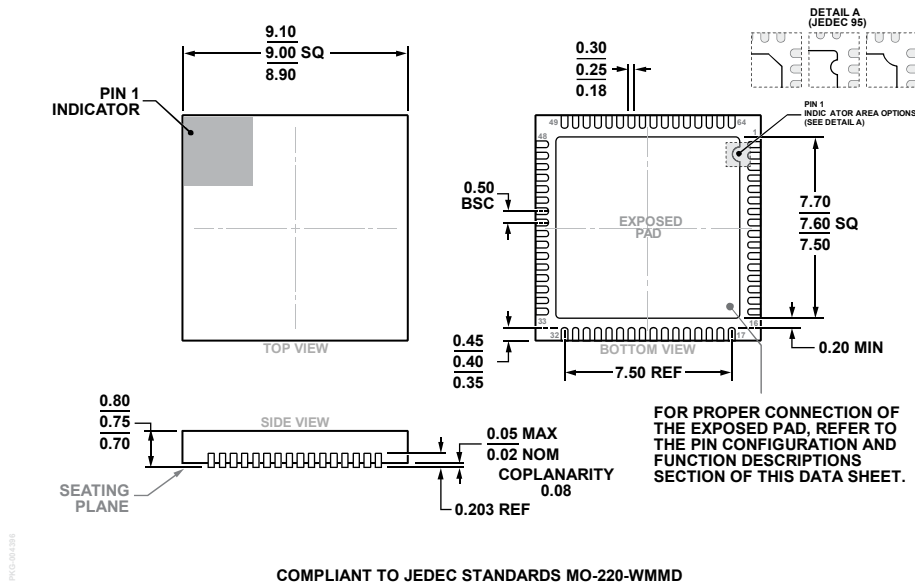

Table 144. Bit Descriptions for SRC_UPDATE

Bits	Bit Name	Settings	Description	Reset	Access
7	SRC_LOAD_SOURCE		Selects which option to load an SRC update	0x0	R/W
[6:1]	RESERVED		Reserved	0x0	R
0	SRC_LOAD_UPDATE		Asserts bit to load SRC registers into SRC	0x0	R/W

OUTLINE DIMENSIONS



COMPLIANT TO JEDEC STANDARDS MO-220-WMMD

Figure 140. 64-Lead Lead Frame Chip Scale Package [LFCSP]
 9 mm × 9 mm Body and 0.75 mm Package Height
 (CP-64-15)
 Dimensions shown in millimeters

ORDERING GUIDE

Model ¹	Temperature Range	Package Description	Package Option
AD7771BCPZ	-40°C to +125°C	64-Lead Lead Frame Chip Scale Package [LFCSP]	CP-64-15
AD7771BCPZ-RL	-40°C to +125°C	64-Lead Lead Frame Chip Scale Package [LFCSP]	CP-64-15
EVAL-AD7771FMCZ		Evaluation Board	
EVAL-SDP-CH1Z		SDP Controller Board	

¹Z = RoHS Compliant Part.

Mouser Electronics

Authorized Distributor

Click to View Pricing, Inventory, Delivery & Lifecycle Information:

[Analog Devices Inc.:](#)

[EVAL-AD7771FMCZ](#) [AD7771BCPZ](#) [AD7771BCPZ-RL](#)