

PRODUCT NUMBER

20020300-XXXXXXLF

PROPERTY TABLE		
FCI SERIES NAME	08-350	
PITCH (mm)	3.50	
VOLTAGE RATING (VAC)	300	
CURRENT RATING (A)	10	
APPLICABLE WIRE RANGE (AWG)	1-WIRE	16~24
	2-WIRE	24
WIRE CROSS SECTION (mm <sup>2</sup> )	1-WIRE	1.5
	2-WIRE	0.5
WIRE CROSS SECTION (mm <sup>2</sup> )	1-WIRE	1.5
	2-WIRE	0.2
OPENING CONTACT HOUSING(mm <sup>2</sup> )	1.6x1.6	
WIRE STRIP LENGTH(mm)	5~6	
TORQUE + / -10% (N-m/Lb-in)	0.19/1.7	
SCREW	M2x0.4	
WITHSTANDING VOLTAGE (kV)	1.6	
OPERATING TEMP. (°C)	-40~+115	
SOLDERING TEMP. (°C)	250±10 (5 sec.)	
POLES AVAILABLE	02~03	
SAFETY CERTIFICATE		

20020300-XXXXXXLF

PITCH

C: 3.50 mm

D: 3.81 mm(ON REQUEST ONLY)

POLES

02: 2 POLES

03: 3 POLES

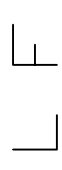
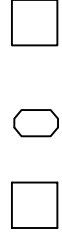
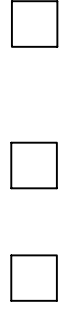

LF : DENOTED RoHS COMPATIBLE

1 : STANDARD PRODUCT  
W/ BOX PACKING

SCREW CODE

CODE	SCREW TYPE	AVAILABILITY
A	-/+	ON REQUEST ONLY
B	-	STANDARD

HOUSING CODE

CODE	COLOR	AVAILABILITY
1	GREEN(RAL 6018/T)	STANDARD
2	BLACK	ON REQUEST ONLY
3	GREY(RAL 7004/P)	ON REQUEST ONLY
4	BLUE(RAL 5015/A)	ON REQUEST ONLY

## NOTES:

## 1. MATERIALS

1-1 HOUSING: THERMALPLASTIC RESIN, UL 94V-0 RATED.

1-2 SCREW: STEEL, ZINC PLATED.

1-3 CLAMP: COPPER ALLOY, NICKEL PLATED.

1-4 TERMINAL: COPPER ALLOY, TIN PLATED.

2. PRODUCT SPECIFICATION REFER TO FCI GS-12-625.

3. PRODUCT PACKING SPECIFICATION REFER TO FCI GS-14-1394.

4. FCI, SAFETY CERTIFICATE LOGO AND SERIES NAME TO BE SHOWN ON PRODUCT SURFACE.

5. THE PRODUCTS WHERE THE PART NUMBER END IN "LF" MEET THE EUROPEAN UNION DIRECTIVE AND OTHER COUNTRY REGULATIONS AS DESCRIBED IN GS-22-008.

6. RECOMMENDED SOLDERING PROCESS BY WAVE SOLDER.

mat'i. code		surface	tolerance	projection	product family	TERMINAL BLOCK
		ASME Y14.5	ASME Y14.5		title	
ltr	ecn no	tolerances unless otherwise specified		MM		
A	T10-0138	WL	X.±0.5	[INCH]	TERMINAL BLOCK	
B	T10-0165	WL	X.X±0.3	scale	FIXED SIGNAL PLUG, VERTICAL WIRE INLET	
		X±1*	X.XX±0.1	dwg no sheet 1 of 2 size		
		dr	WENDY CHEN	20020300 A4		
		enfr	JASON HSU	CUSTOMER Drawing		
		chr	GARY HSIEH			
		appd	JOSEPH HSIA			
sheet	revision	B				
index	sheet	1	2			

PRODUCT NUMBER	SERIES NAME	PITCH
20020300-CXXXXXL	08-350	3.50 mm

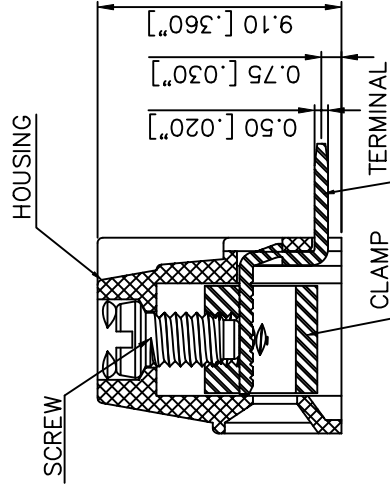
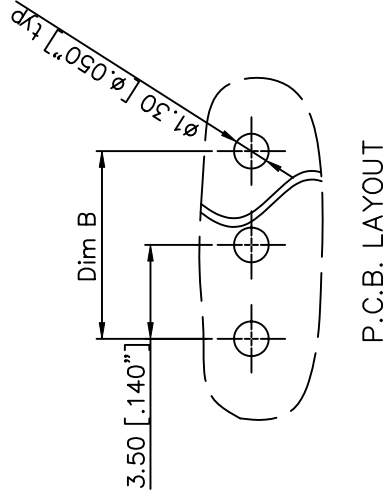
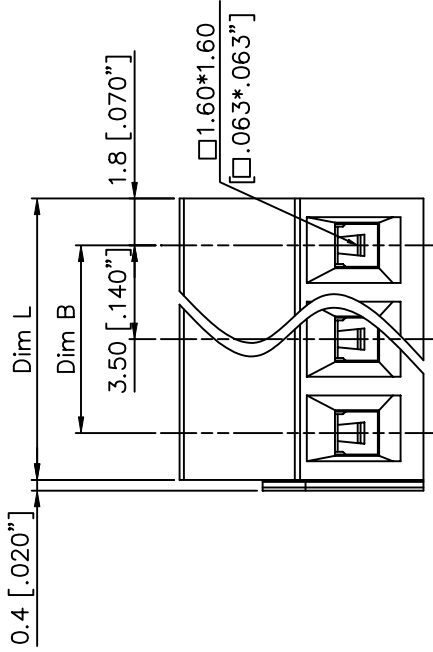
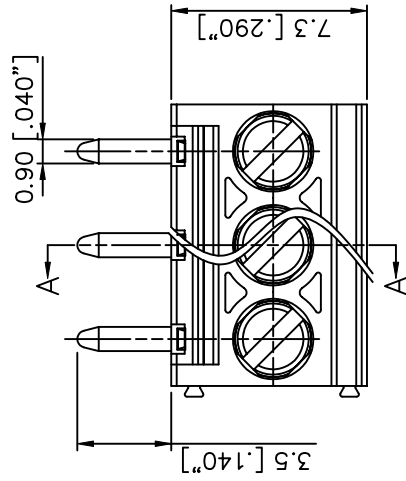

SECTION A-A

POLE	2	3
Dim L	7.00 [.275"]	10.50 [.413"]
Dim B	3.50 [.138"]	7.00 [.276"]
Tol.	±0.10 [.004"]	

mat'l. code	surface	tolerance	projection	product family	TERMINAL BLOCK
	ASME Y14.5	ASME Y14.5		title	
ltr	ecn no	date	tolerances unless otherwise specified	terminal block	FIXED SIGNAL PLUG, VERTICAL WIRE INLET
B			angles	dwg no	sheet 2 of 2
			X±1°	20020300	A4
			X.X±0.5	type	CUSTOMER Drawing
			X.XX±0.3		
			X.XX±0.1		
	dr	WENDY CHEN	081210		
	enfr	JASON HSU	081210		
	chr	GARY HSIEH	081210		
	appd	JOSEPH HSIA	081210		
sheet	revision				
index	sheet				

