

Detector-Filter Combination Series

Planar Diffused Silicon Photodiodes

The Detector-Filter combination series incorporates a filter with a photodiode to achieve a tailored spectral response. OSI Optoelectronics offers a multitude of standard and custom combinations. Upon request, all detector-filter combinations can be provided with a NIST traceable calibration data specified in terms of Amps/Watt, Amps/lumen, Amps/lux or Amps/footcandle.

Among many possible custom combinations, following are a few detector-filter combinations available as standard parts.

PIN-10DF - is a 1 cm² active area, BNC package detector-filter combination, optimized to achieve a flat responsivity, from 450 to 950 nm. This is the spectral response required for radiometric measurements. This type of detector has several advantages over thermopile, such as sensitivity, which is about a thousand times higher, as well as 10 times more stability.

PIN-10AP - is a 1 cm² active area, BNC package detector-filter combination which duplicates the response of the most commonly available optical aid; the human eye. The eye senses both brightness and color, with response varying as a function of the wavelength. This response curve is commonly known as the CIE curve. The AP filters accurately match the CIE curve to within 4% of area.

PIN-555AP - has the same optical characteristics as the PIN 10-AP, with an additional operational amplifier in the same package. The package and the opamp combination is identical to UDT-555D detector-amplifier combination (Photops™).

PIN-005E-550F - uses a low cost broad bandpass filter with peak transmission at 550nm to mimic the CIE curve for photometric applications. The pass band is similar to the CIE curve, but the actual slope of the spectral response curve is quite different. This device can also be used to block the near IR portion of the spectral range, 700 nm and above.

PIN-005D-254F - is a 6 mm² active area, UV enhanced photodiode-filter combination which utilizes a narrow bandpass filter peaking at 254 nm.

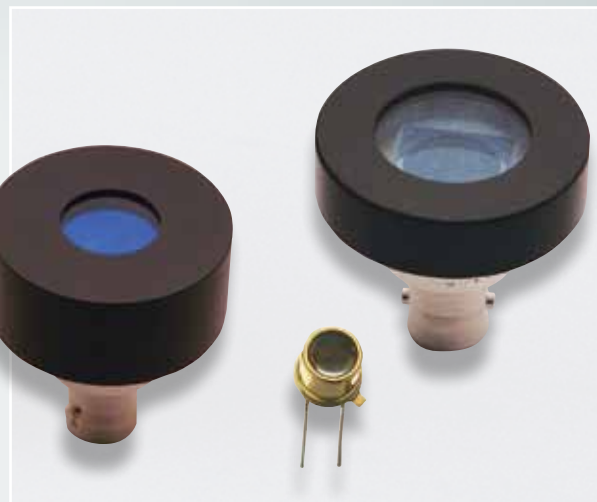

APPLICATIONS

- Analytical Chemistry
- Spectrophotometry
- Densitometers
- Photometry/Radiometry
- Spectoradiometry
- Medical Instrumentation
- Liquid Chromatography

FEATURES

- CIE Match (AP series)
- Flat Band Response (DF)
- 254 Narrow Bandpass
- w/ Amplifier Hybrid
- BNC Packages

CUSTOMIZED CAPABILITIES

Current existing standard photodiodes can be modified by adding various optical filter(s), to match your specific spectral requirements. The filters can either replace the standard glass windows or be used in conjunction with the glass window, depending on the specific requirement and / or nature of the filter. Customer furnished optical filters can also be incorporated in the package. The following are among a few of the optical filter types available. These colored glass filters are grouped into four major categories: Shortpass Filters, Longpass Filters, Bandpass Filters, and Neutral Density Filters. Windows are also available with Custom Thin Film, Anti-reflective, Cut-on and Cut-off Filter Coatings.

ALL PHOTODIODES WITH OR WITHOUT FILTERS CAN BE CALIBRATED IN HOUSE FOR RESPONSIVITY FROM 200 NM TO 1100 NM IN 10 NM STEPS AS WELL AS SINGLE POINT CALIBRATION. ALL OPTICAL CALIBRATIONS ARE NIST TRACEABLE.

Detector-Filter Combination Series

Typical Electro-Optical Specifications at $T_A=23^\circ\text{C}$

Model Number	Active Area		Spectral Match	Responsivity at 550nm		Capacitance (pF)	Shunt Resistance (M Ω)	NEP (W/ $\sqrt{\text{Hz}}$)	Rise Time (μs)	Temp. Range ($^\circ\text{C}$)		Package Style ¶
	Area (mm 2)	Dimensions (mm)	λ_p (nm)	(A/W)	mA/Lum	0 V	-10 mV	-10mV 550 nm	0 V 550 nm 50 Ω	Operating	Storage	
			typ.	typ.	typ.	typ.	typ.					
PIN-10DF	100	11.28 ϕ	$\pm 7\% \ddagger$	0.15	---	1500	20	1.9 e-13	1.0	0 ~ +70	-25 ~ +85	13 / BNC
PIN-10AP-1			4%***	0.27	0.4			1.1 e-13	0.15			33 / Special
PIN-555AP-1§			---	0.23	---			2.5 e-14	0.1*			5 / TO-5
PIN-005E-550F	5.7	2.4 sq.	---	0.025*	---	200	500	3.0 e-13*	---	---	---	5 / TO-5
PIN-005D-254F			---	---	---	---	100	300	---	---	---	18 / TO-5

Detector Filter Combination Series

AP Series

PIN-10DF

PIN-10AP-1

PIN-555AP-1§

PIN-005E-550F

PIN-005D-254F

‡ Point by point from 450nm to 950nm.

§ PIN-555AP is a Detector / Operational Amplifier hybrid. For Op-Amp specifications, please see p.29.

¶ For mechanical drawings please refer to pages 61 thru 73.

* $\lambda=254\text{nm}$

** Non-condensing temperature and storage range, Non-condensing environment.

*** Area within CIE Curve

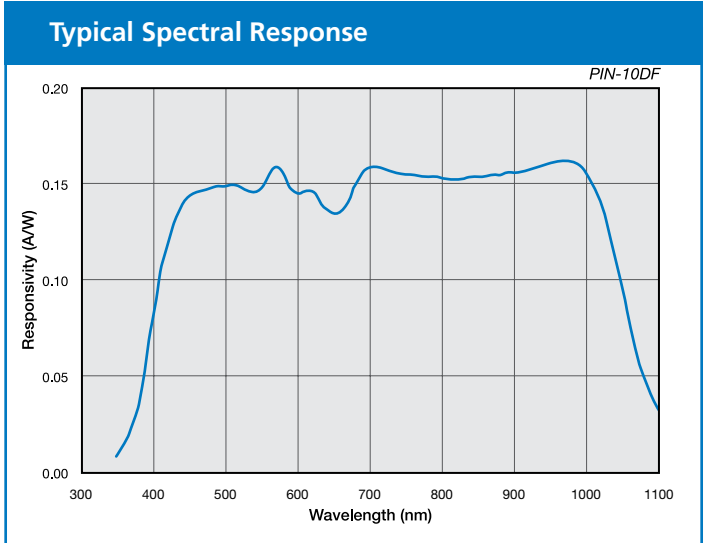
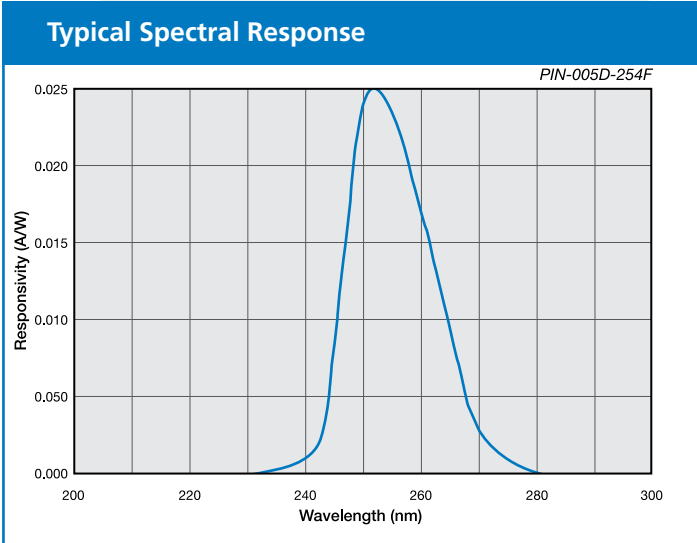
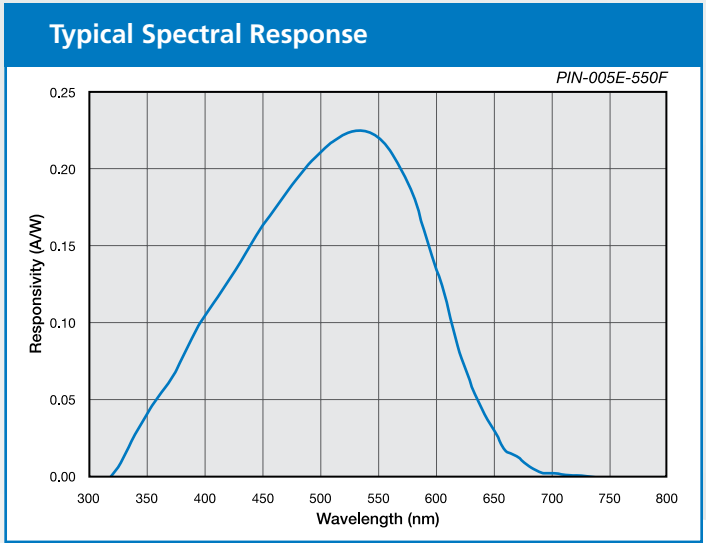
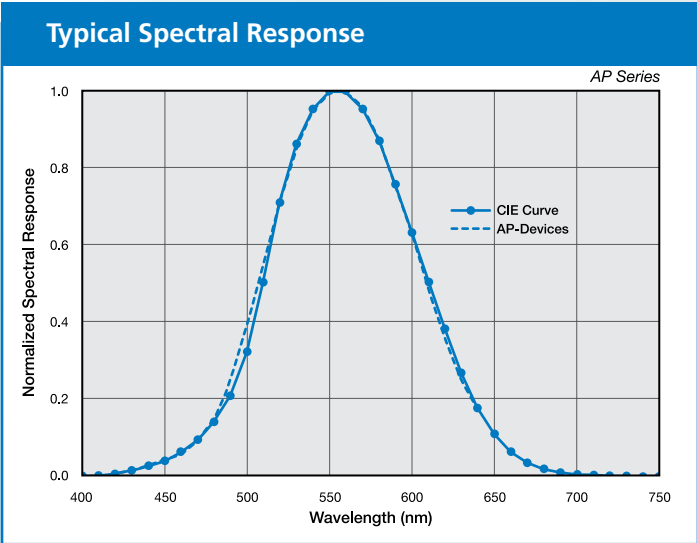

AVOID DIRECT LIGHT

Since the spectral response of silicon photodiode includes the visible light region, care must be taken to avoid photodiode exposure to high ambient light levels, particularly from tungsten sources or sunlight. During shipment from OSI Optoelectronics, your photodiodes are packaged in opaque, padded containers to avoid ambient light exposure and damage due to shock from dropping or jarring.

AVOID SHARP PHYSICAL SHOCK

Photodiodes can be rendered inoperable if dropped or sharply jarred. The wire bonds are delicate and can become separated from the photodiode's bonding pads when the detector is dropped or otherwise receives a sharp physical blow.

CLEAN WINDOWS WITH OPTICAL GRADE CLOTH / TISSUE

Most windows on OSI Optoelectronics photodiodes are either silicon or quartz. They should be cleaned with isopropyl alcohol and a soft (optical grade) pad.

OBSERVE STORAGE TEMPERATURES AND HUMIDITY LEVELS

Photodiode exposure to extreme high or low storage temperatures can affect the subsequent performance of a silicon photodiode. Storage temperature guidelines are presented in the photodiode performance specifications of this catalog. Please maintain a non-condensing environment for optimum performance and lifetime.

OBSERVE ELECTROSTATIC DISCHARGE (ESD) PRECAUTIONS

OSI Optoelectronics photodiodes, especially with IC devices (e.g. Photops) are considered ESD sensitive. The photodiodes are shipped in ESD protective packaging. When unpacking and using these products, anti-ESD precautions should be observed.

DO NOT EXPOSE PHOTODIODES TO HARSH CHEMICALS

Photodiode packages and/or operation may be impaired if exposed to CHLOROTHENE, THINNER, ACETONE, or TRICHLOROETHYLENE.

INSTALL WITH CARE

Most photodiodes in this catalog are provided with wire or pin leads for installation in circuit boards or sockets. Observe the soldering temperatures and conditions specified below:

Soldering Iron:	Soldering 30 W or less Temperature at tip of iron 300°C or lower.
Dip Soldering:	Bath Temperature: 260±5°C. Immersion Time: within 5 Sec. Soldering Time: within 3 Sec.
Vapor Phase Soldering:	DO NOT USE
Reflow Soldering:	DO NOT USE

Photodiodes in plastic packages should be given special care. Clear plastic packages are more sensitive to environmental stress than those of black plastic. Storing devices in high humidity can present problems when soldering. Since the rapid heating during soldering stresses the wire bonds and can cause wire to bonding pad separation, it is recommended that devices in plastic packages to be baked for 24 hours at 85°C.

The leads on the photodiode **SHOULD NOT BE FORMED**. If your application requires lead spacing modification, please contact OSI Optoelectronics Applications group at (310)978-0516 before forming a product's leads. Product warranties could be voided.



*Most of our standard catalog products are RoHS Compliant. Please contact us for details

Mechanical Drawings

Mechanical Specifications and Die Topography

1. Parameter Definitions:

A = Distance from top of chip to top of glass.

a = Photodiode Anode.

B = Distance from top of glass to bottom of case.

c = Photodiode Cathode

(Note: cathode is common to case in metal package products unless otherwise noted).

W = Window Diameter.

F.O.V. = Filed of View (see definition below).

2. Dimensions are in inches (1 inch = 25.4 mm).

3. Pin diameters are 0.018 ± 0.002 " unless otherwise specified.

4. Tolerances (unless otherwise noted)

General: $0.XX \pm 0.01$ "

$0.XXX \pm 0.005$ "

Chip Centering: ± 0.010 "

Dimension 'A': ± 0.015 "

5. Windows

All '**UV**' Enhanced products are provided with QUARTZ glass windows, 0.027 ± 0.002 " thick.

All '**XUV**' products are provided with removable windows.

All '**DLS**' PSD products are provided with A/R coated glass windows.

All '**FIL**' photoconductive and photovoltaic products are epoxy filled instead of glass windows.



$$F.O.V. = \tan^{-1} \left(\frac{W}{2A} \right)$$

For Further Assistance
Please Call One of Our Experienced
Sales and Applications Engineers

310-978-0516

OSI Optoelectronics
An OSI Systems Company

- Or -

visit our website at

www.osioptoelectronics.com

Mechanical Specifications

All units in inches. Pinouts are bottom view.

1 TO-18	2 TO-5	3 TO-8																																	
<p>Products: PIN-020A PIN-040A PIN-040-DP/SB</p> <p>Pin Circle Dia.=0.100</p> <table border="1"> <thead> <tr> <th>P/N</th> <th>A</th> <th>B</th> <th>W</th> </tr> </thead> <tbody> <tr> <td>PIN-020A</td> <td>0.075</td> <td>0.200</td> <td>0.155</td> </tr> <tr> <td>PIN-040A</td> <td>0.075</td> <td>0.200</td> <td>0.155</td> </tr> </tbody> </table>	P/N	A	B	W	PIN-020A	0.075	0.200	0.155	PIN-040A	0.075	0.200	0.155	<p>Products: PIN-5DI PIN-5DPI PIN-13DI PIN-13DPI PIN-5-YAG CD-25T</p> <p>Pin Circle Dia.=0.200</p> <table border="1"> <thead> <tr> <th>P/N</th> <th>A</th> <th>B</th> <th>W</th> </tr> </thead> <tbody> <tr> <td>All Others</td> <td>0.094</td> <td>0.180</td> <td>0.240</td> </tr> <tr> <td>CD-25T</td> <td>0.050</td> <td>0.130</td> <td>0.23</td> </tr> </tbody> </table>	P/N	A	B	W	All Others	0.094	0.180	0.240	CD-25T	0.050	0.130	0.23	<p>Products: PIN-6DI PIN-6DPI PIN-44DI PIN-44DPI APD50-8-150-TO8</p> <p>Pin Circle Dia.=0.295</p> <table border="1"> <thead> <tr> <th>P/N</th> <th>A</th> </tr> </thead> <tbody> <tr> <td>PIN-6DI/6DPI APD50-8-150-TO8</td> <td>0.115</td> </tr> <tr> <td>PIN-44DI/44DPI</td> <td>0.125</td> </tr> <tr> <td>OSD35-0</td> <td>0.130</td> </tr> </tbody> </table>	P/N	A	PIN-6DI/6DPI APD50-8-150-TO8	0.115	PIN-44DI/44DPI	0.125	OSD35-0	0.130	
P/N	A	B	W																																
PIN-020A	0.075	0.200	0.155																																
PIN-040A	0.075	0.200	0.155																																
P/N	A	B	W																																
All Others	0.094	0.180	0.240																																
CD-25T	0.050	0.130	0.23																																
P/N	A																																		
PIN-6DI/6DPI APD50-8-150-TO8	0.115																																		
PIN-44DI/44DPI	0.125																																		
OSD35-0	0.130																																		
<p>Products: PIN-2DI PIN-2DPI PIN-3CDI PIN-3CDP PIN-3CDPI</p> <p>Pin Circle Dia.=0.100</p> <table border="1"> <thead> <tr> <th>A</th> <th>B</th> </tr> </thead> <tbody> <tr> <td>0.070</td> <td>0.200</td> </tr> <tr> <td>0.090</td> <td>0.150</td> </tr> </tbody> </table>	A	B	0.070	0.200	0.090	0.150	<p>Products: PIN-5D PIN-5DP PIN-5DP/SB PIN-13D PIN-13DP PIN-005E-550F OSD-5-0 OSD15-0 OSD5-5T OSD15-5T UV-001 UV-005 UV-005DQ UV-005EQ UV-013DQ UV-013EQ UV-015</p> <p>Pin Circle Dia.=0.200</p> <table border="1"> <thead> <tr> <th>P/N</th> <th>A</th> <th>B</th> </tr> </thead> <tbody> <tr> <td>OSD-Prefix Devices</td> <td>0.050</td> <td>0.130</td> </tr> <tr> <td>UV-XXXDQ</td> <td>0.065</td> <td>0.138</td> </tr> <tr> <td>UV-XXXEQ</td> <td>0.055</td> <td>0.138</td> </tr> <tr> <td>All Others</td> <td>0.102</td> <td>0.180</td> </tr> </tbody> </table> <p>Quartz Window: OSD5.8-7Q UV Transmissive Window: OSD5.8-7U</p>	P/N	A	B	OSD-Prefix Devices	0.050	0.130	UV-XXXDQ	0.065	0.138	UV-XXXEQ	0.055	0.138	All Others	0.102	0.180	<p>Products: PIN-6D PIN-6DP PIN-44D PIN-44DP UV-020 UV-035DQ UV-035EQ UV-035</p> <p>Pin Circle Dia.=0.295</p> <table border="1"> <thead> <tr> <th>P/N</th> <th>A</th> <th>B</th> </tr> </thead> <tbody> <tr> <td>UV-035DQ</td> <td>0.130</td> <td>0.195</td> </tr> <tr> <td>UV-035EQ</td> <td>0.120</td> <td>0.195</td> </tr> <tr> <td>All Others</td> <td>0.140</td> <td>0.205</td> </tr> </tbody> </table>	P/N	A	B	UV-035DQ	0.130	0.195	UV-035EQ	0.120	0.195	All Others	0.140	0.205
A	B																																		
0.070	0.200																																		
0.090	0.150																																		
P/N	A	B																																	
OSD-Prefix Devices	0.050	0.130																																	
UV-XXXDQ	0.065	0.138																																	
UV-XXXEQ	0.055	0.138																																	
All Others	0.102	0.180																																	
P/N	A	B																																	
UV-035DQ	0.130	0.195																																	
UV-035EQ	0.120	0.195																																	
All Others	0.140	0.205																																	
<p>Products: PIN-3CD PIN-3CDP BPX-65 OSD1-0 OSD1-5T OSD3-5T OSD1-E OSD3-E</p> <p>Pin Circle Dia.=0.100</p> <table border="1"> <thead> <tr> <th>P/N</th> <th>A</th> <th>B</th> </tr> </thead> <tbody> <tr> <td>PIN-3CD / 3CDP</td> <td>0.087</td> <td>0.146</td> </tr> <tr> <td>BPX-65</td> <td>0.075</td> <td>0.200</td> </tr> <tr> <td>OSD-Prefix Devices</td> <td>0.080</td> <td>0.200</td> </tr> </tbody> </table> <p>Quartz Window: OSD1.2-7Q UV Transmissive Window: OSD1.2-7U</p>	P/N	A	B	PIN-3CD / 3CDP	0.087	0.146	BPX-65	0.075	0.200	OSD-Prefix Devices	0.080	0.200	<p>Products: PIN-125DPL</p> <p>Pin Circle Dia.=0.100</p>	<p>Products: PIN-HR005 PIN-HR008 PIN-HR020 PIN-HR026 PIN-HR040</p> <p>Pin Circle Dia.=0.100</p>																					
P/N	A	B																																	
PIN-3CD / 3CDP	0.087	0.146																																	
BPX-65	0.075	0.200																																	
OSD-Prefix Devices	0.080	0.200																																	

Mechanical Specifications

All units in inches. Pinouts are bottom view.

10 Low Profile

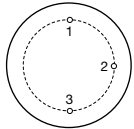
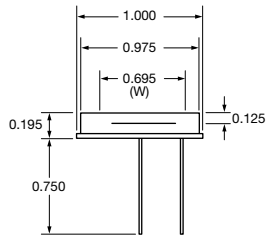

Pin Circle Dia.=0.73

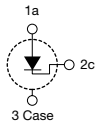

Products:

PIN-10DI
PIN-10DPI
PIN-10DPI/SB
UV-50L
UV-100L

11 BNC

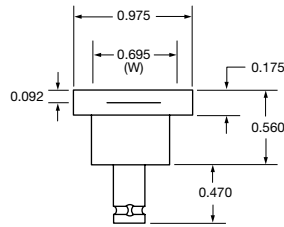

Outer Contact — Anode	PIN-10D, PIN-10DP, PIN-10DP/SB UV-100DQ, UV-100EQ
Outer Contact — Cathode	UV-50, UV-100

Products:

PIN-10D
PIN-10DP
PIN-10DP/SB
UV-50
UV-100
UV-100DQ
UV-100EQ

12 BNC

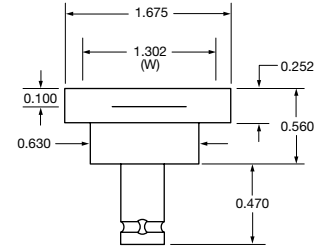

Outer Contact — Anode

Products:

PIN-25D
PIN-25DP

13 Special BNC

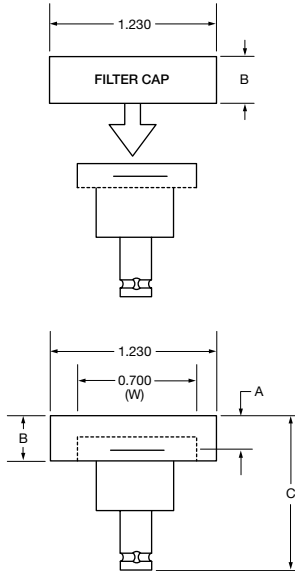

Dimensions			
P/N	A	B	C
PIN-10DF	0.217	0.330	1.020
PIN-10AP	0.386	0.550	1.415

Products:

PIN-10AP
PIN-10DF

14 TO-5

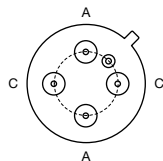
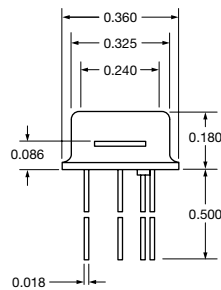

Pin Circle Dia.= 0.200
Bottom View

Products:

DLS-2S

15 Special Plastic

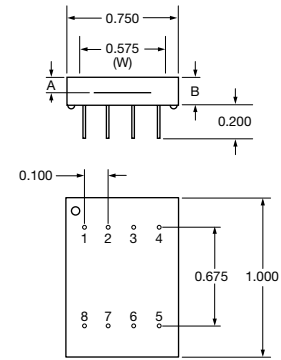

Dimensions

P/N	A	B
FIL-UV50	0.090	0.155

Pinouts

P/N	1	2	3	4	5	6	7	8
FIL-UV50	c	-	-	a	c	-	-	a

Mechanical Specifications

All units in inches. Pinouts are bottom view.

16 TO-18 Lensed Cap

Products:

PIN-HR005L
PIN-HR008L
PIN-HR020L
PIN-HR026L
PIN-HR040L

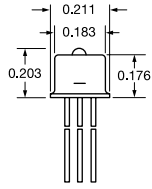

Pin Circle Dia.=0.100

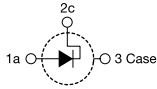

17 TO-5

Products:

PIN-DSS
PIN-DSIn

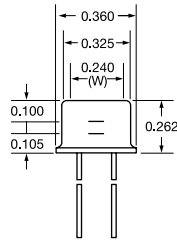

Pin Circle Dia.=0.220

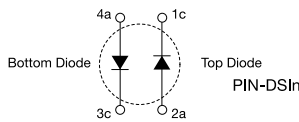
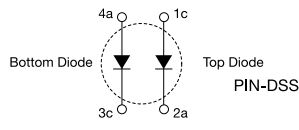

18 TO-5

Products:

PIN-005D-245F

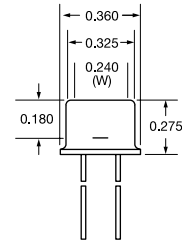

Pin Circle Dia.=0.215

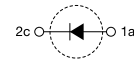

19 Plastic Mold

Products:

BPW34
BPW34B
BPW34S

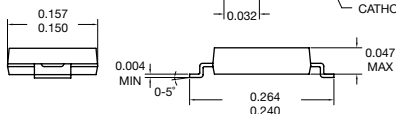
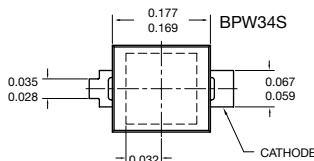
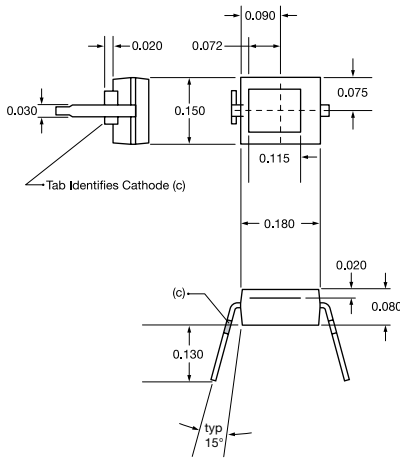

20 Special Metal

Products:

SPOT-15-YAG
SPOT-9-YAG
PIN-100-YAG

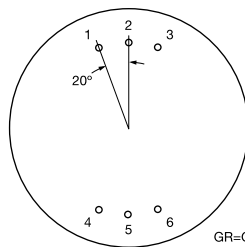
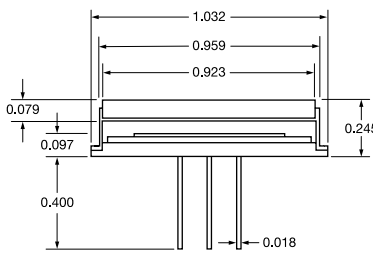

Pin Circle Dia.=0.750

Pinouts

P/N	1	2	3	4	5	6
SPOT-15-YAG	C1	GR	C4	C2	A	C3
SPOT-9-YAG	C1	GR	C4	C2	A	C3
PIN-100-YAG	--	C	--	--	A	--

21 Special Metal

Products:

SC-50D

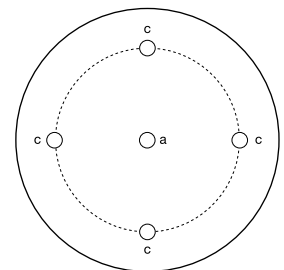
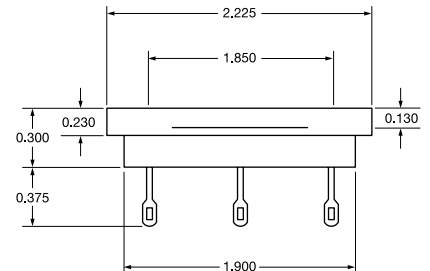

Pin Circle Dia.=1.110

Mechanical Specifications

All units in inches. Pinouts are bottom view.

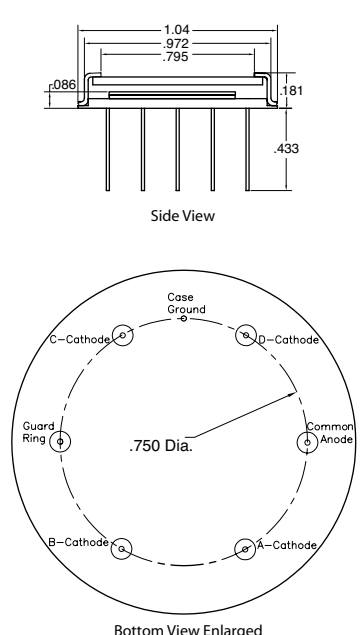
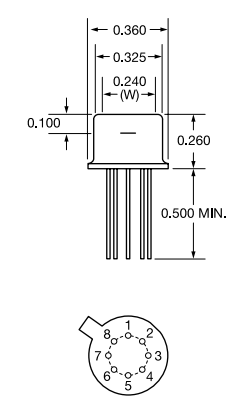
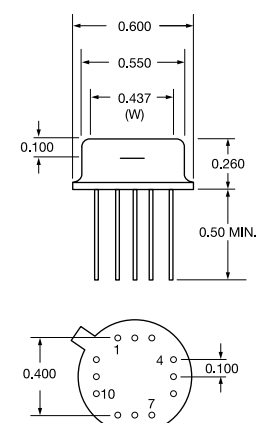
29 Metal	30 TO-5	31 TO-8																																																																						
<p>Products: SPOT-13-YAG-FL SPOT-11-YAG-FL</p>  <p>Side View</p> <p>Bottom View Enlarged</p>	<p>Products: UDT-455 UDT-455UV OSI-515</p>  <p>Pin Circle Dia.=0.23</p> <table border="1"> <thead> <tr> <th colspan="2">Pinout</th> </tr> </thead> <tbody> <tr><td>1</td><td>Offset Null</td></tr> <tr><td>2</td><td>Inverting Input Detector Cathode</td></tr> <tr><td>3</td><td>Noninverting Input</td></tr> <tr><td>4</td><td>V (-)</td></tr> <tr><td>5</td><td>Offset Null</td></tr> <tr><td>6</td><td>Output</td></tr> <tr><td>7</td><td>V (+)</td></tr> <tr><td>8</td><td>Detector Anode</td></tr> </tbody> </table> <p>OSI-515 pin 1 & 5 are N/C</p>	Pinout		1	Offset Null	2	Inverting Input Detector Cathode	3	Noninverting Input	4	V (-)	5	Offset Null	6	Output	7	V (+)	8	Detector Anode	<p>Products: UDT-020D PIN-020UV</p>  <p>Pin Circle Dia.=0.295</p> <table border="1"> <thead> <tr> <th colspan="2">UDT-020D Pinout</th> <th colspan="2">PIN-020UV</th> </tr> </thead> <tbody> <tr><td>1</td><td>Not Used</td><td>1</td><td>Not Used</td></tr> <tr><td>2</td><td>Not Used</td><td>2</td><td>Not Used</td></tr> <tr><td>3</td><td>Not Used</td><td>3</td><td>Not Used</td></tr> <tr><td>4</td><td>Not Used</td><td>4</td><td>Not Used</td></tr> <tr><td>5</td><td>Inverting Input</td><td>5</td><td>Inverting Input</td></tr> <tr><td>6</td><td>Noninverting Input</td><td>6</td><td>Noninverting Input</td></tr> <tr><td>7</td><td>Detector Cathode</td><td>7</td><td>Detector Cathode</td></tr> <tr><td>8</td><td>Case Ground</td><td>8</td><td>Case Ground</td></tr> <tr><td>9</td><td>Detector Anode</td><td>9</td><td>Detector Anode</td></tr> <tr><td>10</td><td>V (-)</td><td>10</td><td>V (-)</td></tr> <tr><td>11</td><td>Output</td><td>11</td><td>Output</td></tr> <tr><td>12</td><td>V (+)</td><td>12</td><td>V (+)</td></tr> </tbody> </table>	UDT-020D Pinout		PIN-020UV		1	Not Used	1	Not Used	2	Not Used	2	Not Used	3	Not Used	3	Not Used	4	Not Used	4	Not Used	5	Inverting Input	5	Inverting Input	6	Noninverting Input	6	Noninverting Input	7	Detector Cathode	7	Detector Cathode	8	Case Ground	8	Case Ground	9	Detector Anode	9	Detector Anode	10	V (-)	10	V (-)	11	Output	11	Output	12	V (+)	12	V (+)
Pinout																																																																								
1	Offset Null																																																																							
2	Inverting Input Detector Cathode																																																																							
3	Noninverting Input																																																																							
4	V (-)																																																																							
5	Offset Null																																																																							
6	Output																																																																							
7	V (+)																																																																							
8	Detector Anode																																																																							
UDT-020D Pinout		PIN-020UV																																																																						
1	Not Used	1	Not Used																																																																					
2	Not Used	2	Not Used																																																																					
3	Not Used	3	Not Used																																																																					
4	Not Used	4	Not Used																																																																					
5	Inverting Input	5	Inverting Input																																																																					
6	Noninverting Input	6	Noninverting Input																																																																					
7	Detector Cathode	7	Detector Cathode																																																																					
8	Case Ground	8	Case Ground																																																																					
9	Detector Anode	9	Detector Anode																																																																					
10	V (-)	10	V (-)																																																																					
11	Output	11	Output																																																																					
12	V (+)	12	V (+)																																																																					

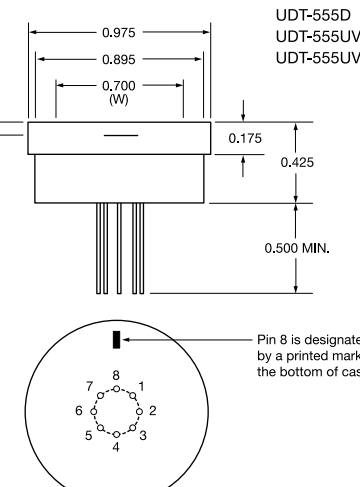
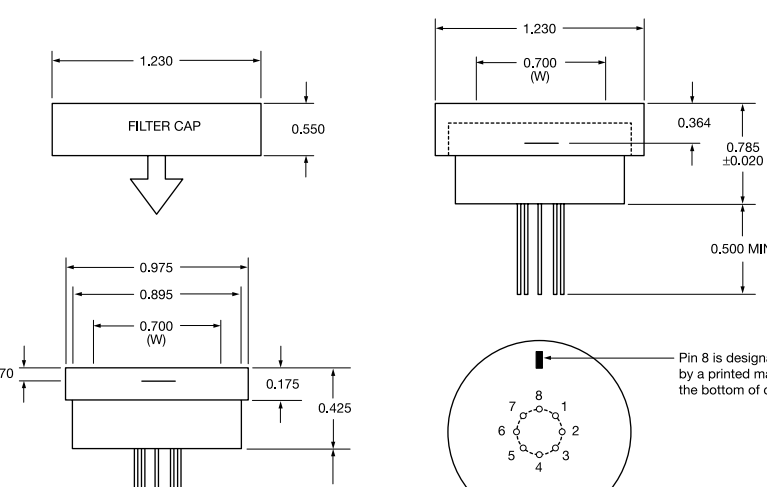
32 Special	33 Special																																				
<p>Products: UDT-055UV UDT-555D UDT-555UV UDT-555UV/LN</p>  <p>Pin Circle Dia.=0.230</p> <table border="1"> <thead> <tr> <th colspan="2">Pinout</th> </tr> </thead> <tbody> <tr><td>1</td><td>Offset Null</td></tr> <tr><td>2</td><td>Inverting Input Detector Cathode</td></tr> <tr><td>3</td><td>Noninverting Input</td></tr> <tr><td>4</td><td>V (-)</td></tr> <tr><td>5</td><td>Offset Null</td></tr> <tr><td>6</td><td>Output</td></tr> <tr><td>7</td><td>V (+)</td></tr> <tr><td>8</td><td>Detector Anode and Case</td></tr> </tbody> </table>	Pinout		1	Offset Null	2	Inverting Input Detector Cathode	3	Noninverting Input	4	V (-)	5	Offset Null	6	Output	7	V (+)	8	Detector Anode and Case	<p>Products: PIN-555AP</p>  <p>Pin Circle Dia.=0.230</p> <table border="1"> <thead> <tr> <th colspan="2">Pinout</th> </tr> </thead> <tbody> <tr><td>1</td><td>Offset Null</td></tr> <tr><td>2</td><td>Inverting Input Detector Cathode</td></tr> <tr><td>3</td><td>Noninverting Input</td></tr> <tr><td>4</td><td>V (-)</td></tr> <tr><td>5</td><td>Offset Null</td></tr> <tr><td>6</td><td>Output</td></tr> <tr><td>7</td><td>V (+)</td></tr> <tr><td>8</td><td>Detector Anode and Case</td></tr> </tbody> </table>	Pinout		1	Offset Null	2	Inverting Input Detector Cathode	3	Noninverting Input	4	V (-)	5	Offset Null	6	Output	7	V (+)	8	Detector Anode and Case
Pinout																																					
1	Offset Null																																				
2	Inverting Input Detector Cathode																																				
3	Noninverting Input																																				
4	V (-)																																				
5	Offset Null																																				
6	Output																																				
7	V (+)																																				
8	Detector Anode and Case																																				
Pinout																																					
1	Offset Null																																				
2	Inverting Input Detector Cathode																																				
3	Noninverting Input																																				
4	V (-)																																				
5	Offset Null																																				
6	Output																																				
7	V (+)																																				
8	Detector Anode and Case																																				