

5

4

3

2

1



D

C

B

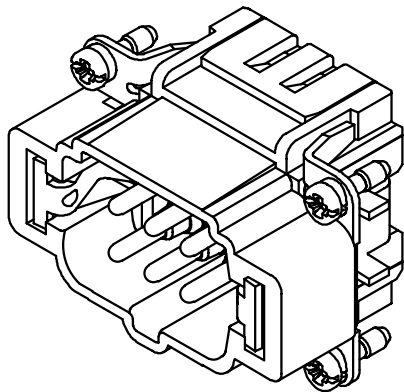
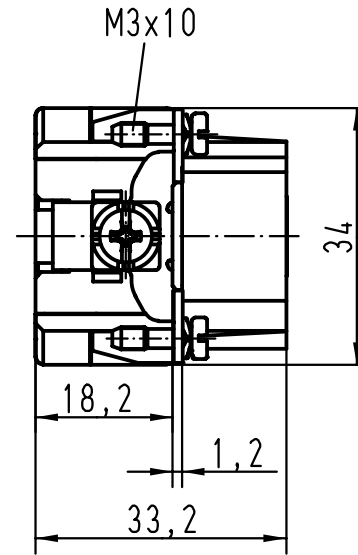
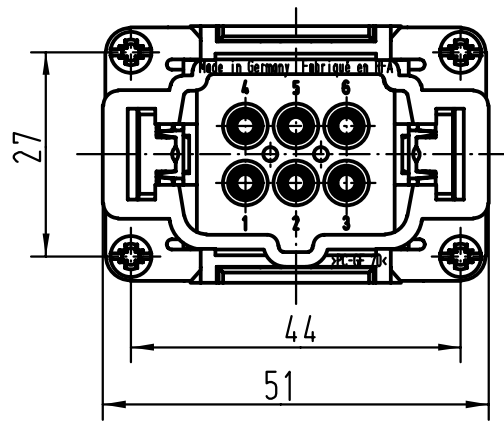
A



 All Dimensions in mm Original Size DIN A 4		Techn. Character.			Nicht tolerierte Masse/ Free size tolerances	
			Dat.	Name	Massstab/Scale 1:1	Han 6ES-sti Stifteinsatz/male insert
			Detail.	16.03.00 ROH.		
			Insp.	SDT		
			Stand.			
27341			HARTING KGaA			TB 09 33 006 2616 Sub.
Mod.	Dat.	Name	D-32339 ESPELKAMP			
						Blatt/ page