

SOT-23-3L Plastic-Encapsulate MOSFETS

■ Features

- $V_{DS} (V) = -60V$
- $I_D = -1.25 A (V_{GS} = -10V)$
- $R_{DS(ON)} < 340m\ \Omega (V_{GS} = -10V)$
- $R_{DS(ON)} < 550m\ \Omega (V_{GS} = -4.5V)$
- Pb-Free Package May be Available. The G-Suffix Denotes a Pb-Free Lead Finish

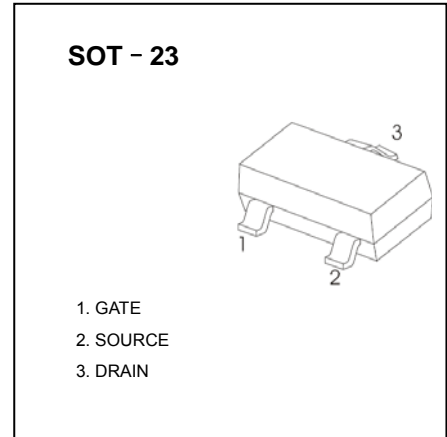

MARKING

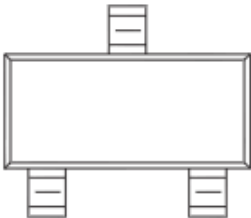

Equivalent Circuit

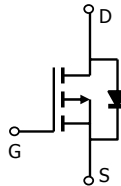

■ Absolute Maximum Ratings $T_a = 25^\circ C$

Parameter	Symbol	Rating	Unit
Drain-Source Voltage	V_{DS}	-60	V
Gate-Source Voltage	V_{GS}	± 20	
Continuous Drain Current *1,*2 $T_a = 25^\circ C$ $T_a = 70^\circ C$	I_D	-1.25	A
		-0.85	
Pulsed Drain Current	I_{DM}	-8	
Avalanche Current $L=0.1mH$	I_{AS}	-5	W
Power Dissipation *1,*2 $T_a = 25^\circ C$ $T_a = 70^\circ C$	P_D	1.25	
		0.8	
Thermal Resistance.Junction- to-Ambient $t \leq 5$ sec Steady State *1	R_{thJA}	100	$^\circ C/W$
		166	
Thermal Resistance.Junction- to-Case *1	R_{thJC}	60	
Junction Temperature	T_J	150	$^\circ C$
Storage Temperature Range	T_{stg}	-55 to 150	

*1 Surface Mounted on FR4 Board.

*2 $t \leq 5$ sec.

SOT-23-3L Plastic-Encapsulate MOSFETS
■ Electrical Characteristics Ta = 25°C

Parameter	Symbol	Test Conditions	Min	Typ	Max	Unit
Drain-Source Breakdown Voltage	V _{DSS}	I _D =-250 μ A, V _{GS} =0V	-60			V
Zero Gate Voltage Drain Current	I _{DSS}	V _{Ds} =-48V, V _{GS} =0V			-1	μ A
		V _{Ds} =-48V, V _{GS} =0V, T _J =125°C			-50	
Gate-Body leakage current	I _{GSS}	V _{Ds} =0V, V _{GS} =±20V			±100	nA
Gate Threshold Voltage	V _{GS(th)}	V _{Ds} =V _{GS} I _D =-250 μ A	-1		-3	V
Static Drain-Source On-Resistance *1	R _{DS(on)}	V _{GS} =-10V, I _D =-1.25A			340	m Ω
		V _{GS} =-4.5V, I _D =-1A			550	
On state drain current *1	I _{D(ON)}	V _{GS} =-4.5V, V _{Ds} =-10V	-6			A
Forward Transconductance *1	g _{FS}	V _{Ds} =-4.5V, I _D =-1A		1.9		S
Total Gate Charge	Q _g	V _{GS} =-10V, V _{Ds} =-30V, I _D =-1.25A		5.4	12	nC
Gate Source Charge	Q _{gs}			1.15		
Gate Drain Charge	Q _{gd}			0.92		
Turn-On DelayTime	t _{d(on)}	V _{GS} =-4.5V, V _{Ds} =-30V, R _L =30 Ω, R _{GEN} =6 Ω I _D =-1A		10.5	20	ns
Turn-On Rise Time	t _r			11.5	20	
Turn-Off DelayTime	t _{d(off)}			15.5	30	
Turn-Off Fall Time	t _f			7.5	15	
Body Diode Reverse Recovery Time	t _{rr}	I _F =-1.25A, di/dt=100A/μ s		30	55	
Maximum Body-Diode Continuous Current	I _S				-1.25	A
Diode Forward Voltage	V _{SD}	I _S =-1.25A, V _{GS} =0V		-0.82	-1.2	V

*1 Pulse test; pulse width ≤ 300us, duty cycle ≤ 2%.

■ Typical Characteristics

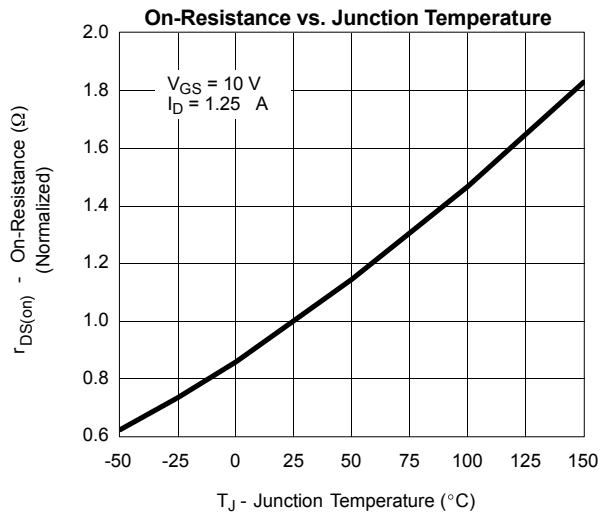
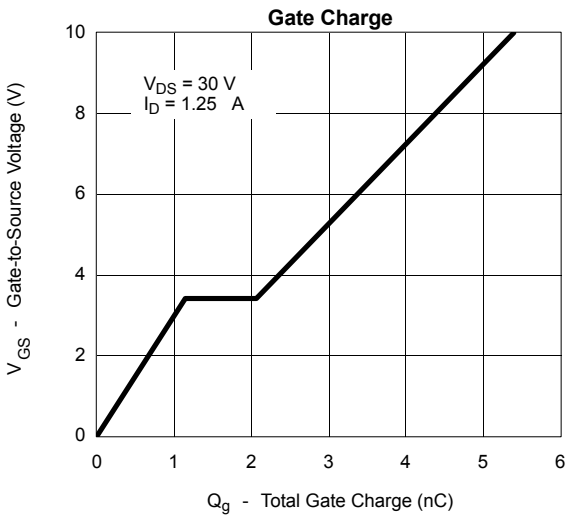
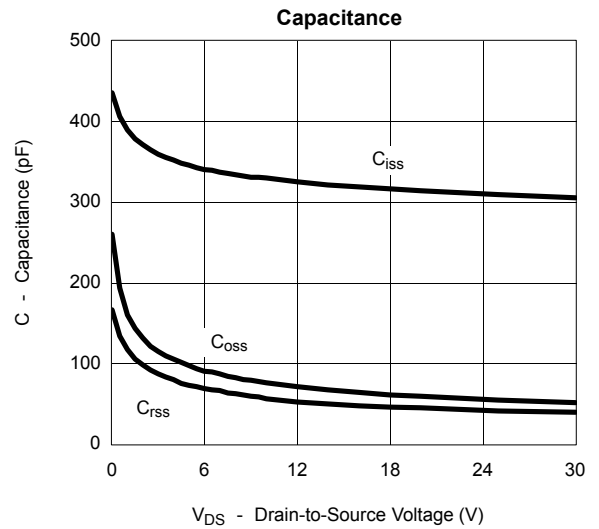
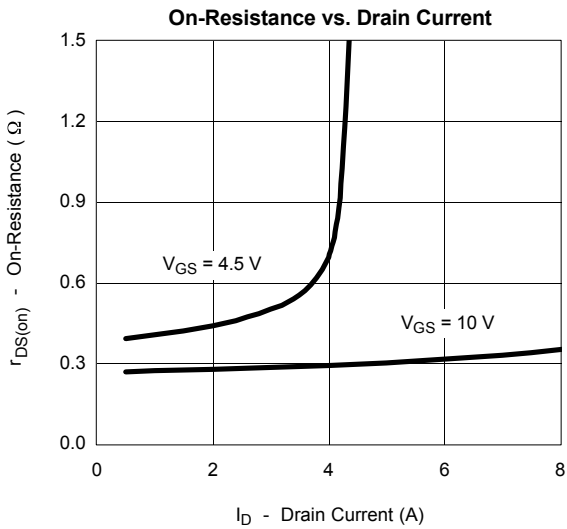
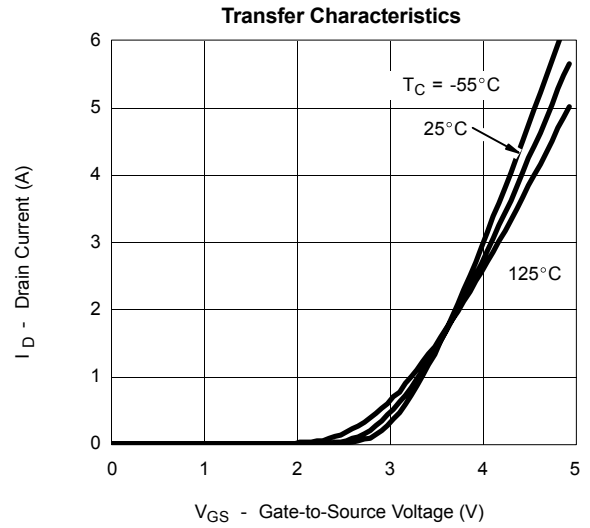
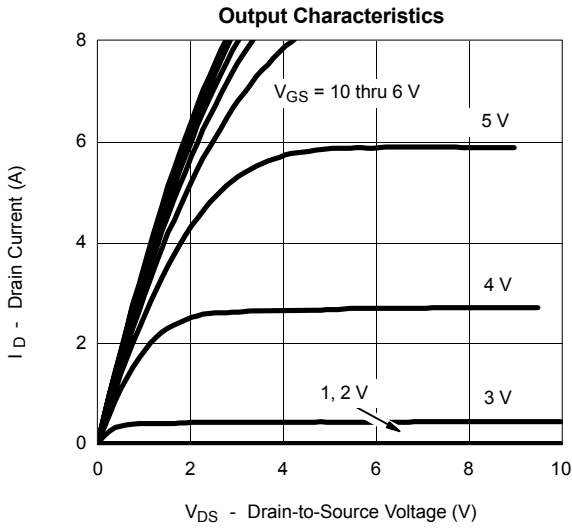

■ Typical Characteristics

Source-Drain Diode Forward Voltage

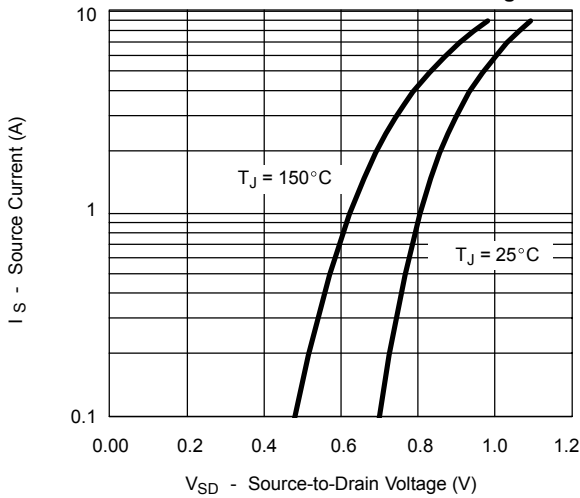

On-Resistance vs. Gate-to-Source Voltage

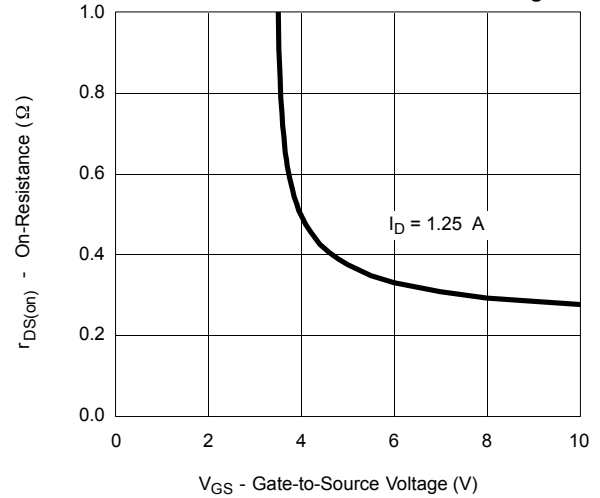

Threshold Voltage

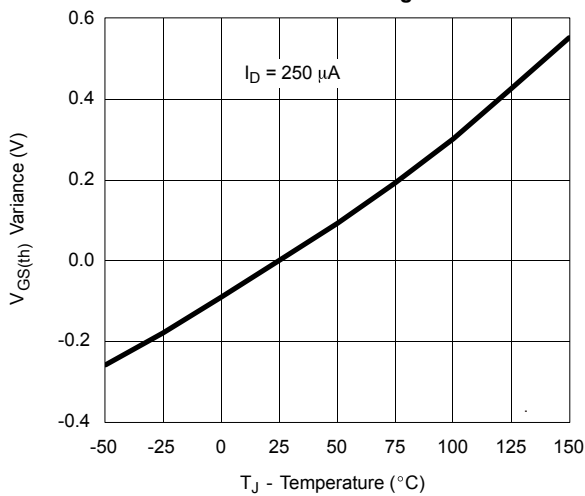

Single Pulse Power

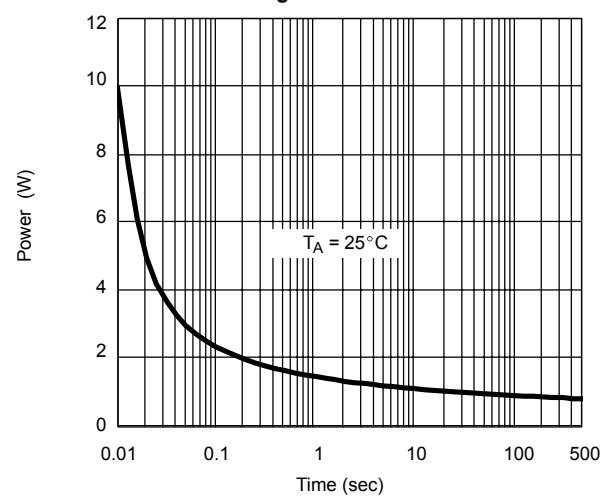

Safe Operating Area, Junction-to-Ambient

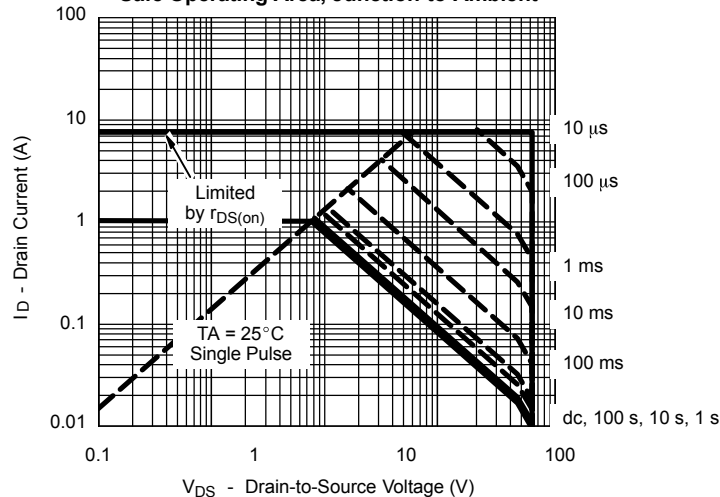

■ Typical Characteristics

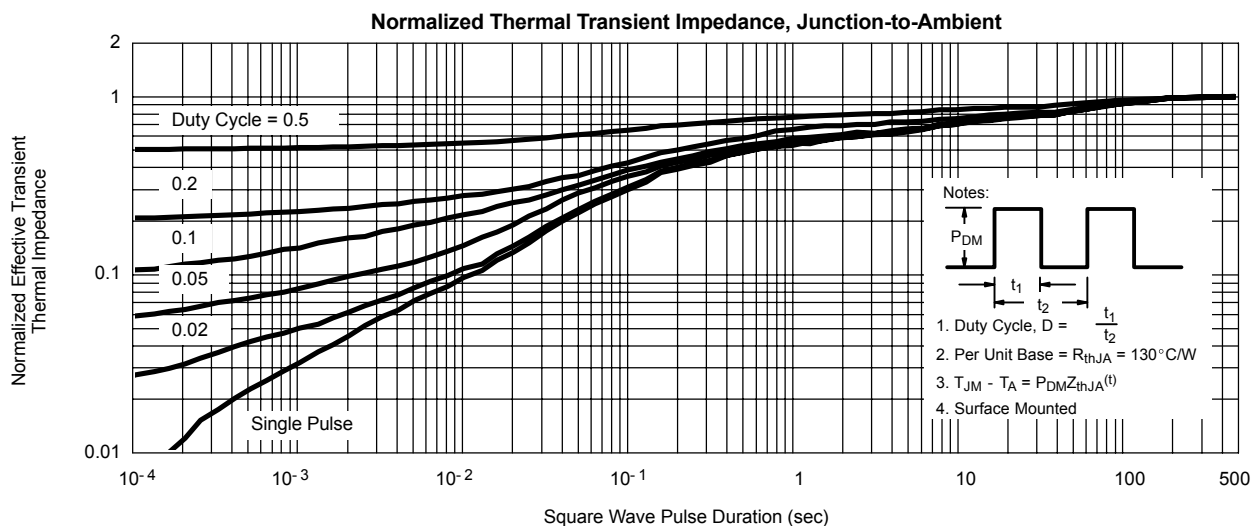

SOT-23 PACKAGE OUTLINE DIMENSIONS

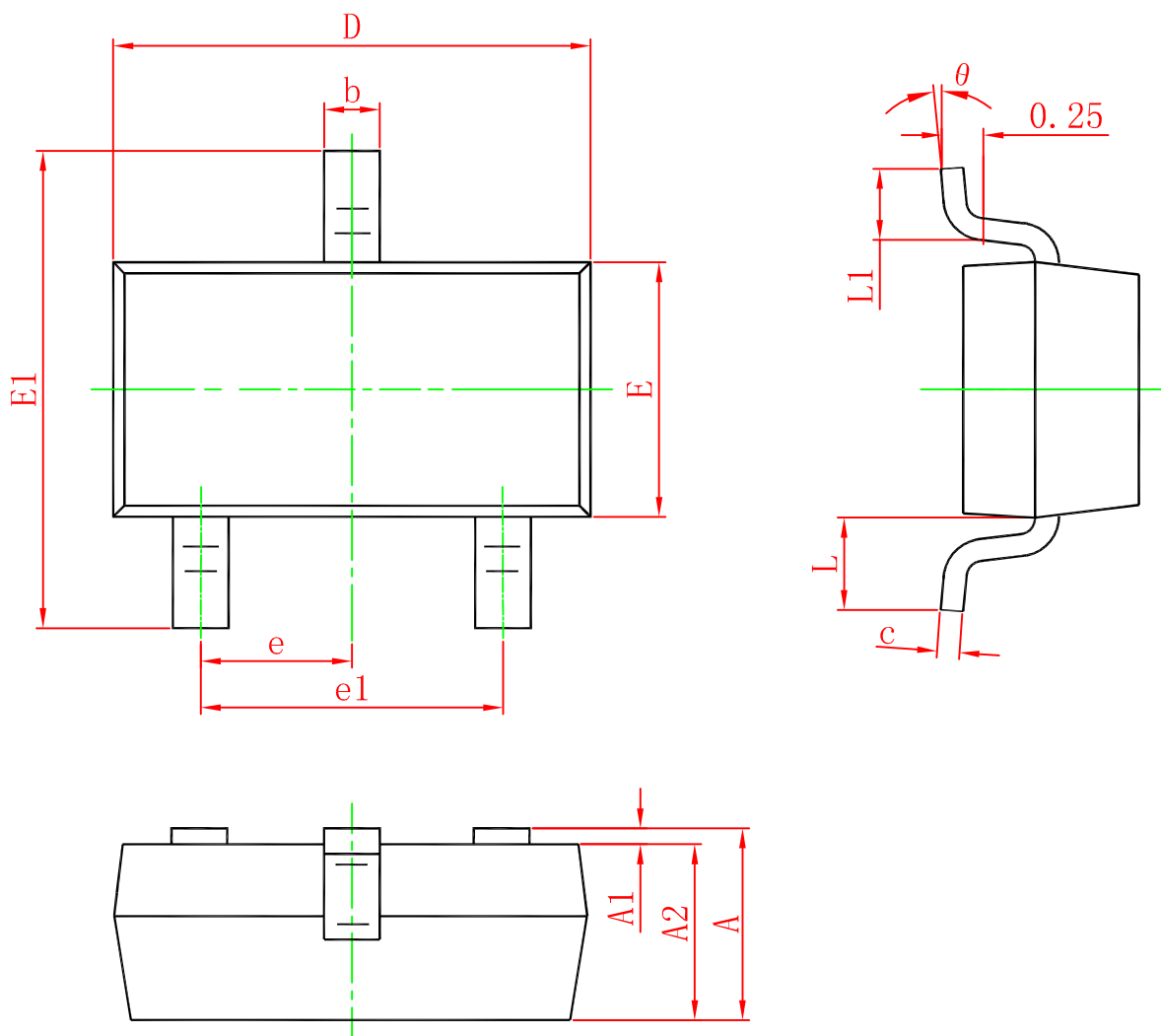

Symbol	Dimensions In Millimeters		Dimensions In Inches	
	Min.	Max.	Min.	Max.
A	0.900	1.150	0.035	0.045
A1	0.000	0.100	0.000	0.004
A2	0.900	1.050	0.035	0.041
b	0.300	0.500	0.012	0.020
c	0.080	0.150	0.003	0.006
D	2.800	3.000	0.110	0.118
E	1.200	1.400	0.047	0.055
E1	2.250	2.550	0.089	0.100
e	0.950 TYP.		0.037 TYP.	
e1	1.800	2.000	0.071	0.079
L	0.550 REF.		0.022 REF.	
L1	0.300	0.500	0.012	0.020
θ	0°	8°	0°	8°