

■ Features

- $V_{DS} (V) = 60V$
- $I_D = 3 A (V_{GS} = 10V)$
- $R_{DS(ON)} < 80m\Omega (V_{GS} = 10V), I_D=3A$
- $R_{DS(ON)} < 95m\Omega (V_{GS} = 4.5V), I_D=1.9A$

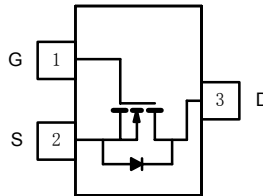
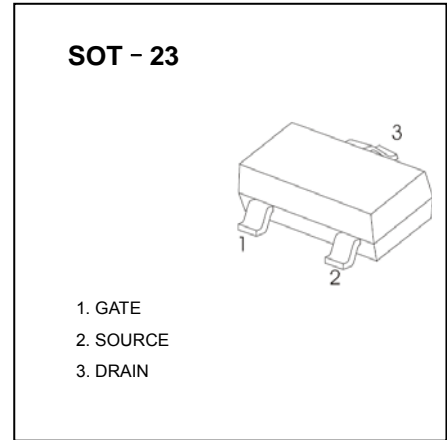

■ Absolute Maximum Ratings $T_a = 25^\circ C$

Parameter	Symbol	Rating	Unit
Drain-Source Voltage	V_{DS}	60	V
Gate-Source Voltage	V_{GS}	± 20	
Continuous Drain Current	I_D	$T_a=25^\circ C$	3
		$T_a=70^\circ C$	1.9
Pulsed Drain Current	I_{DM}	10	A
Power Dissipation	P_D	$T_a=25^\circ C$	1.25
		$T_a=70^\circ C$	0.8
Thermal Resistance.Junction- to-Ambient	R_{thJA}	(Note.1)	100
		(Note.2)	166
Junction Temperature	T_J	150	$^\circ C$
Storage Temperature Range	T_{stg}	-55 to 150	

Note.1: Surface Mounted on FR4 Board, $t \leq 5 \text{ sec.}$

Note.2: Surface Mounted on FR4 Board

■ **Electrical Characteristics Ta = 25°C**

Parameter	Symbol	Test Conditions	Min	Typ	Max	Unit
Drain-Source Breakdown Voltage	V _{DSS}	I _D =250 μA, V _{GS} =0V	60			V
Zero Gate Voltage Drain Current	I _{DSS}	V _{DS} =60V, V _{GS} =0V			0.5	μA
		V _{DS} =60V, V _{GS} =0V, T _J =55°C			10	
Gate-Body Leakage Current	I _{GSS}	V _{DS} =0V, V _{GS} =±20V			±100	nA
Gate Threshold Voltage	V _{GS(th)}	V _{DS} =V _{GS} , I _D =250 μA	1		3	V
Static Drain-Source On-Resistance	R _{DS(on)}	V _{GS} =10V, I _D = 3A			80	mΩ
		V _{GS} =4.5V, I _D =1.9A			95	
On State Drain Current	I _{D(ON)}	V _{GS} ≥4.5V, V _{DS} =10V	6			A
		V _{GS} ≥4.5V, V _{DS} =4.5V	4			
Forward Transconductance	g _{FS}	V _{DS} =4.5V, I _D =2A		4.6		S
Input Capacitance	C _{iss}	V _{GS} =0V, V _{DS} =25V, f=1MHz		240		pF
Output Capacitance	C _{oss}			50		
Reverse Transfer Capacitance	C _{rss}			15		
Gate Resistance	R _g	V _{GS} =0V, V _{DS} =0V, f=1MHz	0.5		3.3	Ω
Total Gate Charge	Q _g	V _{GS} =10V, V _{DS} =30V, I _D =2A		4.8	10	nC
Gate Source Charge	Q _{gs}			0.8		
Gate Drain Charge	Q _{gd}			1		
Turn-On DelayTime	t _{d(on)}	V _{GS} =4.5V, V _{DS} =30V, I _D =1A, R _L =30Ω, R _G =6Ω		7	15	ns
Turn-On Rise Time	t _r			10	20	
Turn-Off DelayTime	t _{d(off)}			17	35	
Turn-Off Fall Time	t _f			6	15	
Maximum Body-Diode Continuous Current	I _S				1	A
Diode Forward Voltage	V _{SD}	I _S =1A, V _{GS} =0V			1.2	V

Note. Pulse test; pulse width ≤ 300 us, duty cycle ≤ 2%.

■ Typical Characteristics

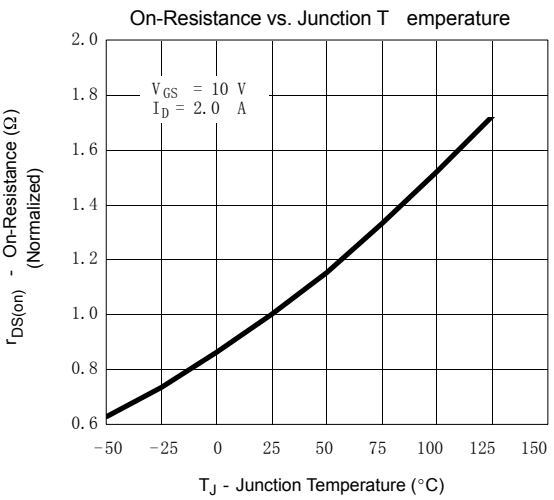
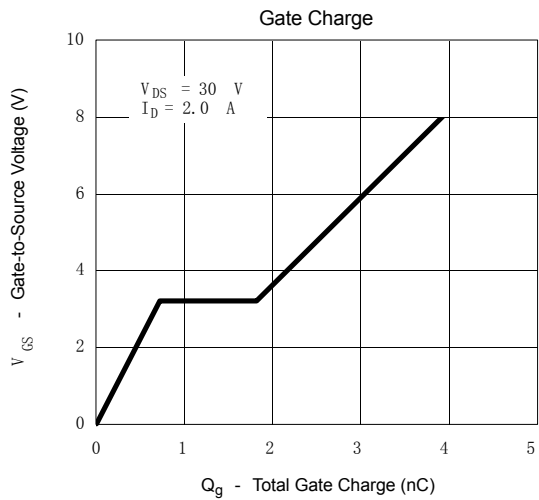
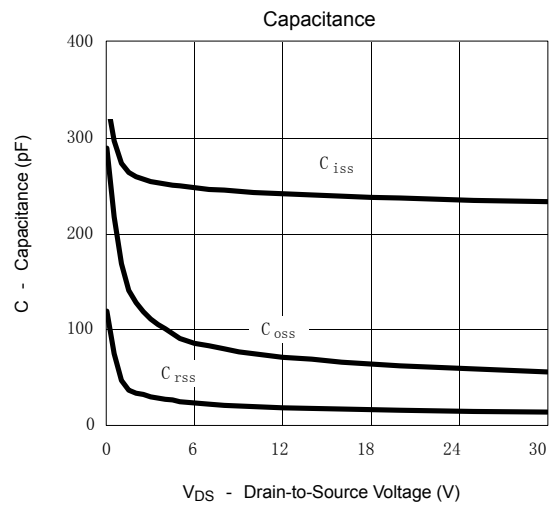
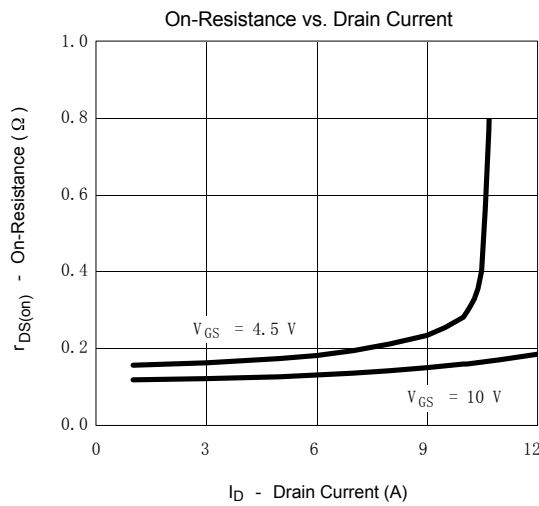
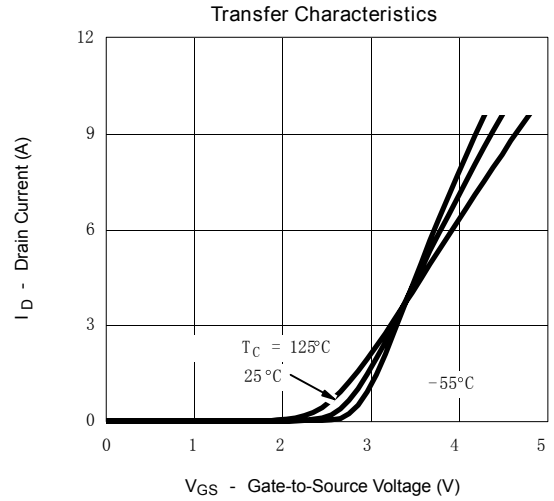
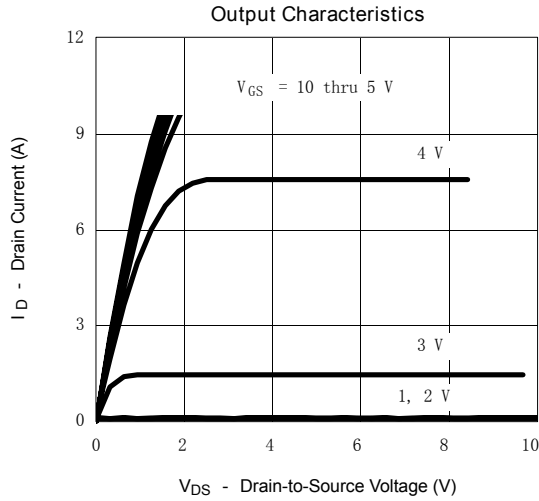

■ Typical Characteristics

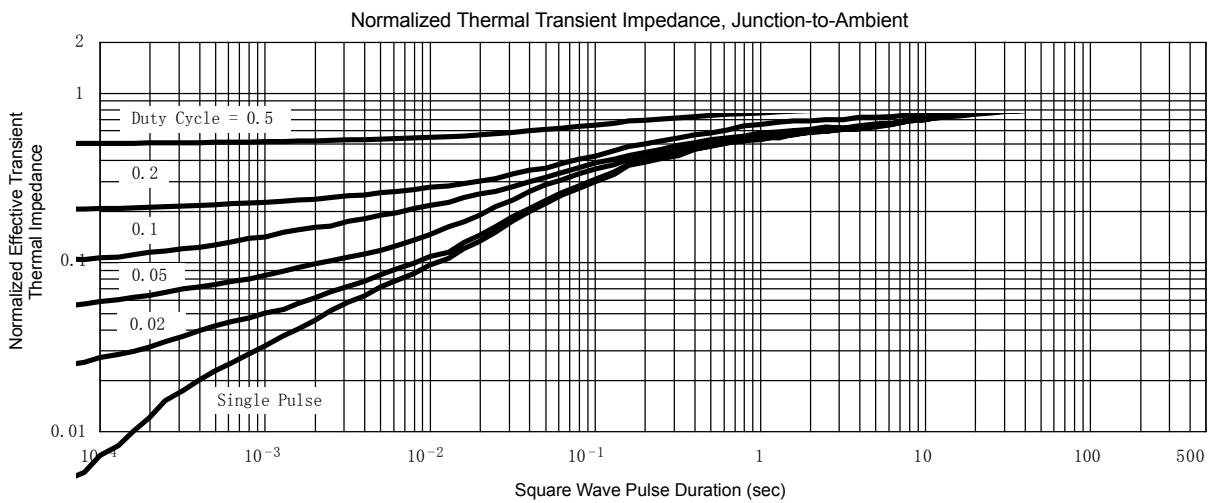
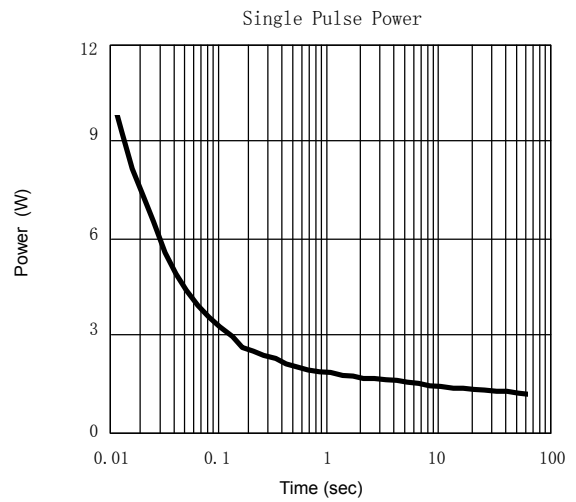
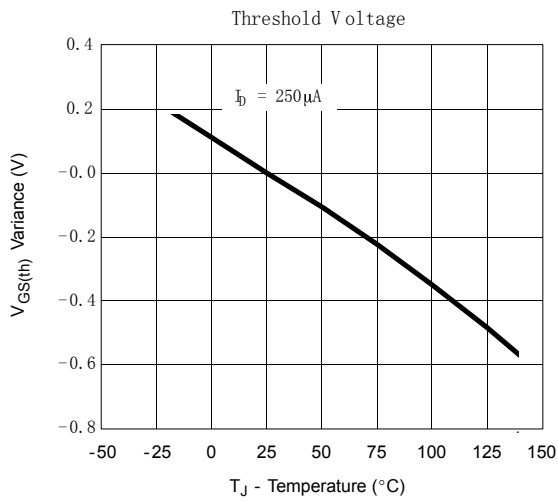
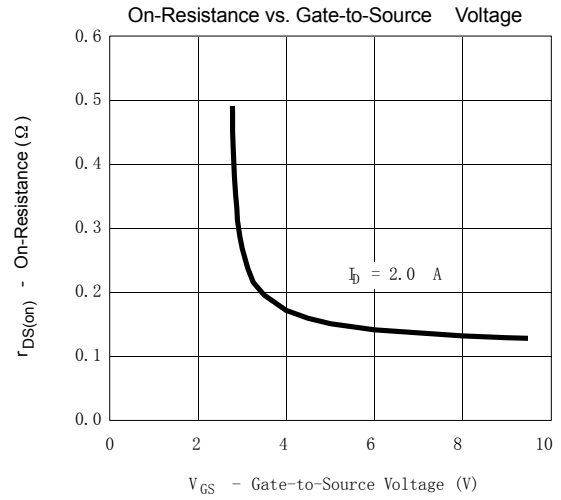
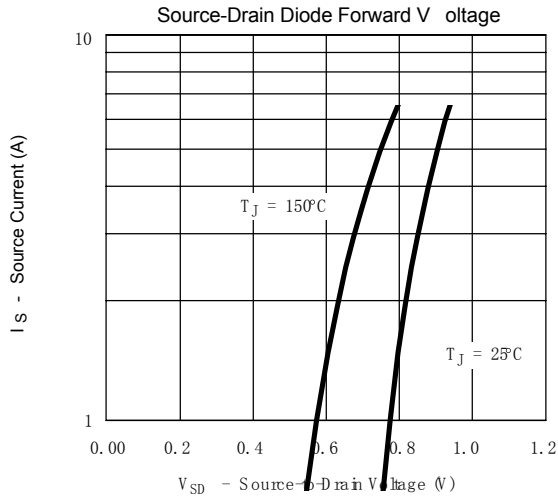

SOT-23 PACKAGE OUTLINE DIMENSIONS

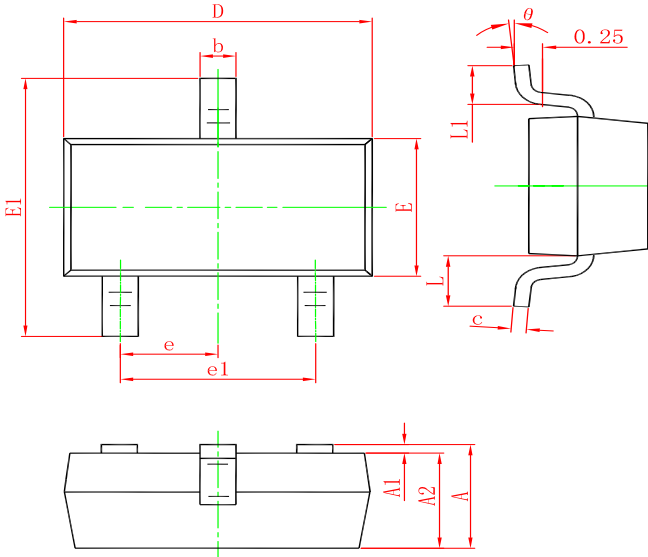

Symbol	Dimensions In Millimeters		Dimensions In Inches	
	Min.	Max.	Min.	Max.
A	0.900	1.150	0.035	0.045
A1	0.000	0.100	0.000	0.004
A2	0.900	1.050	0.035	0.041
b	0.300	0.500	0.012	0.020
c	0.080	0.150	0.003	0.006
D	2.800	3.000	0.110	0.118
E	1.200	1.400	0.047	0.055
E1	2.250	2.550	0.089	0.100
e	0.950 TYP.		0.037 TYP.	
e1	1.800	2.000	0.071	0.079
L	0.550 REF.		0.022 REF.	
L1	0.300	0.500	0.012	0.020
θ	0°	8°	0°	8°

Marking

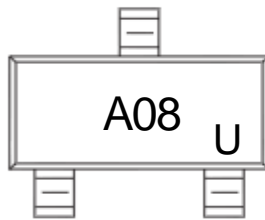

Ordering information

Order code	Package	Baseqty	Deliverymode
UMW SI2308A	SOT-23	3000	Tape and reel