

N-Channel Enhancement MOSFET

■ Features

- $V_{DS}=20V$
- $R_{DS(on)}=45m\Omega@V_{GS}=4.5V, I_D=3.6A$
- $R_{DS(on)}=60m\Omega@V_{GS}=2.5V, I_D=3.1A$

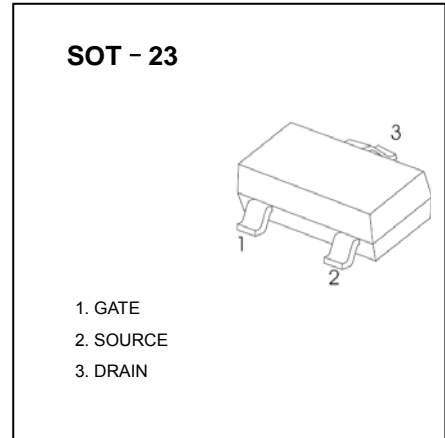
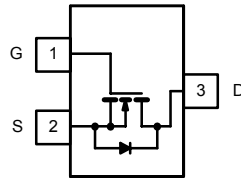

■ Absolute Maximum Ratings $T_a = 25^\circ C$

Parameter	Symbol	Rating	Unit
Drain-Source Voltage	V_{DS}	20	V
Gate-Source Voltage	V_{GS}	± 8	
Continuous Drain Current *1	I_D	$T_a=25^\circ C$	3.6
		$T_a=70^\circ C$	3.1
Pulsed Drain Current	I_{DM}	10	A
Power Dissipati	P_D	$T_a=25^\circ C$	1.25
		$T_a=70^\circ C$	0.8
Thermal Resistance.Junction- to-Ambient *1	R_{thJA}		100
		*2	166
Junction Temperature	T_J	150	$^\circ C$
Storage Temperature Range	T_{stg}	-55 to 150	

Notes:

*1.Surface Mounted on FR4 Board, $t \leq 5$ sec.

*2.Surface Mounted on FR4 Board.

N-Channel Enhancement MOSFET
■ Electrical Characteristics Ta = 25°C

Parameter	Symbol	Test Conditions	Min	Typ	Max	Unit
Drain-Source Breakdown Voltage	V _{DSS}	I _D =250 μA, V _{GS} =0V	20			V
Zero Gate Voltage Drain Current	I _{DSS}	V _{DS} =20V, V _{GS} =0V			1	μA
		V _{DS} =20V, V _{GS} =0V, T _J =55 °C			10	
Gate-Body Leakage Current	I _{GSS}	V _{DS} =0V, V _{GS} =±8V			±100	nA
Gate Threshold Voltage	V _{GS(th)}	V _{DS} =V _{GS} , I _D =250 μA	0.62	0.95	1.9	V
Static Drain-Source On-Resistance	R _{DS(on)}	V _{GS} =4.5V, I _D =3.6A			45	mΩ
		V _{GS} =2.5V, I _D =3.1A			60	
Forward Transconductance *	g _{fs}	V _{DS} =5V, I _D =3.6A		8		S
Input Capacitance	C _{iss}	V _{GS} =0V, V _{DS} =10V, f=1MHz		300		pF
Output Capacitance	C _{oss}			120		
Reverse Transfer Capacitance	C _{rss}			80		
Total Gate Charge	Q _g	V _{DS} =10V, V _{GS} =4.5V, I _D =3.6A		4	10	nC
Gate-Source Charge	Q _{gs}			0.65		
Gate-Drain Charge	Q _{gd}			1.5		
Turn-On DelayTime	t _{d(on)}	V _{GS} =4.5V, V _{DS} =10V, R _L =5.5 Ω, R _{GEN} =6 Ω I _D =3.6A		7	15	ns
Turn-On Rise Time	t _r			55	80	
Turn-Off DelayTime	t _{d(off)}			16	60	
Turn-Off Fall Time	t _f			10	25	
Continuous Source Current (Diode Conduction)	I _S			1.6		A
Diode Forward Voltage	V _{SD}	I _S =1.6A, V _{GS} =0V		0.76	1.2	V

* Pulse test: PW ≤ 300us duty cycle ≤ 2%

N-Channel Enhancement MOSFET

■ Typical Characteristics

Output Characteristics

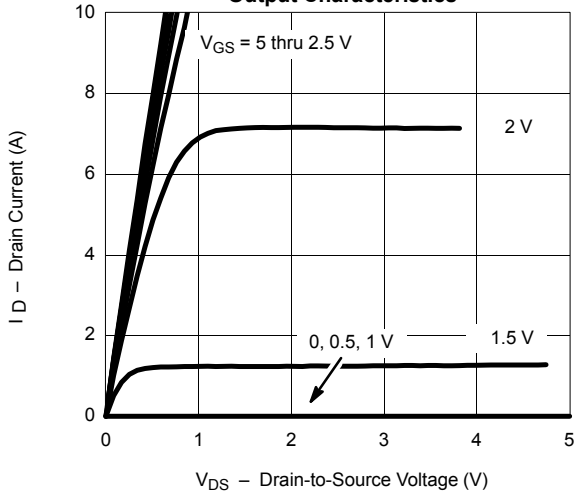

Transfer Characteristics

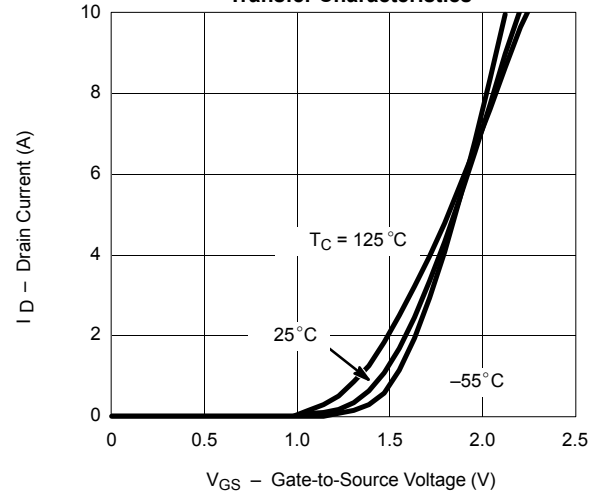

On-Resistance vs. Drain Current

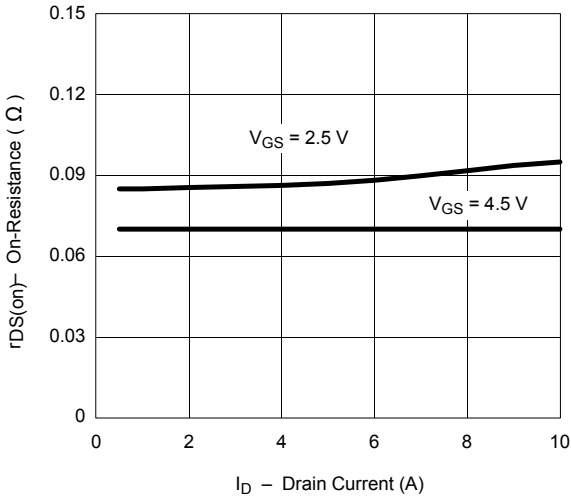

Capacitance

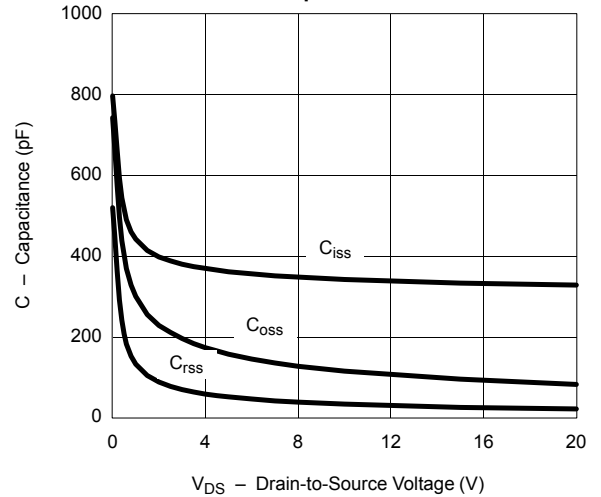

Gate Charge

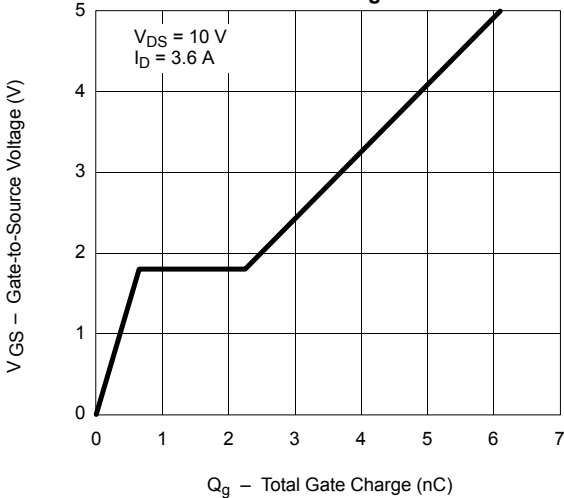

On-Resistance vs. Junction Temperature

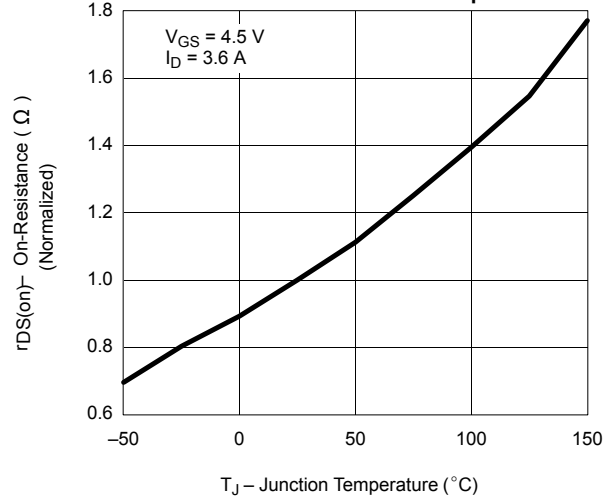

N-Channel Enhancement MOSFET

■ Typical Characteristics

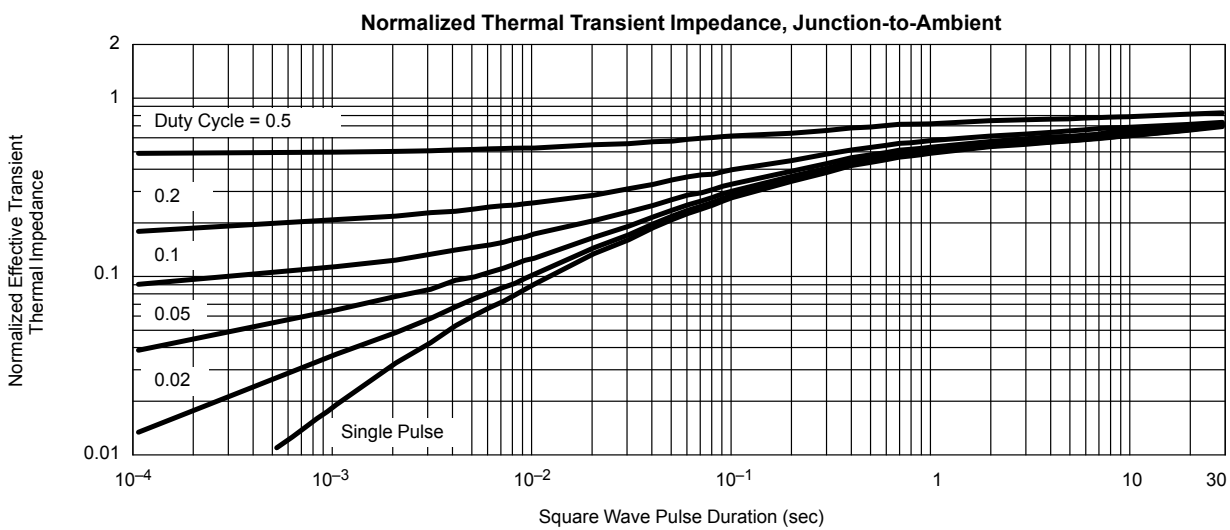
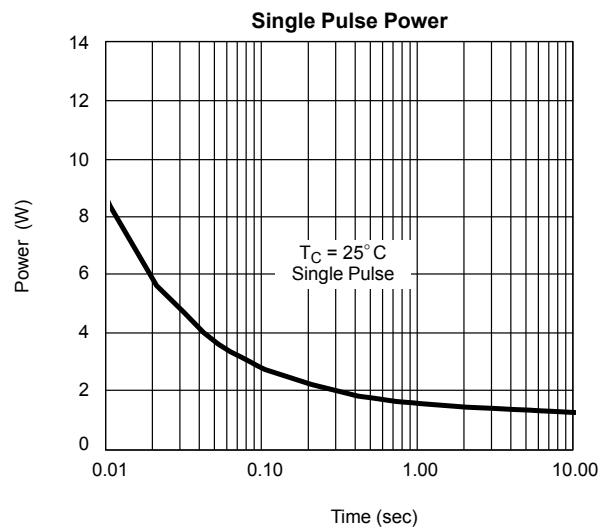
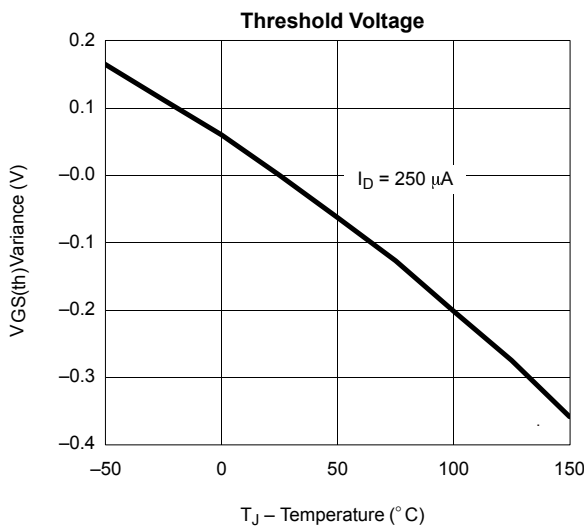
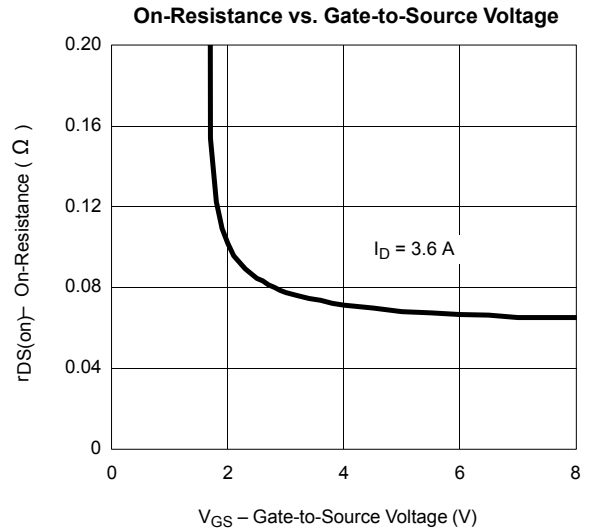
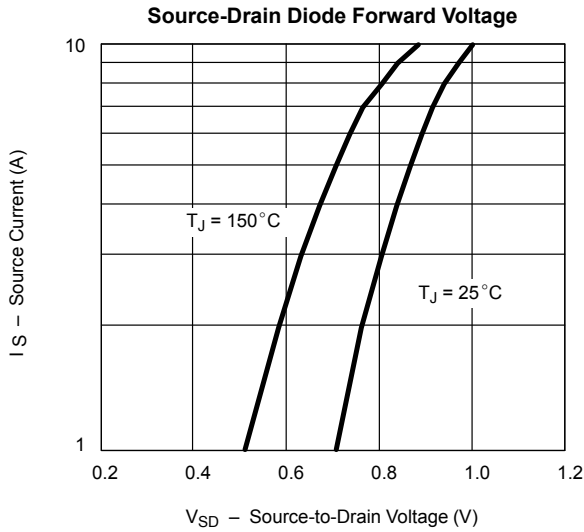

N-Channel Enhancement MOSFET

SOT-23 PACKAGE OUTLINE DIMENSIONS

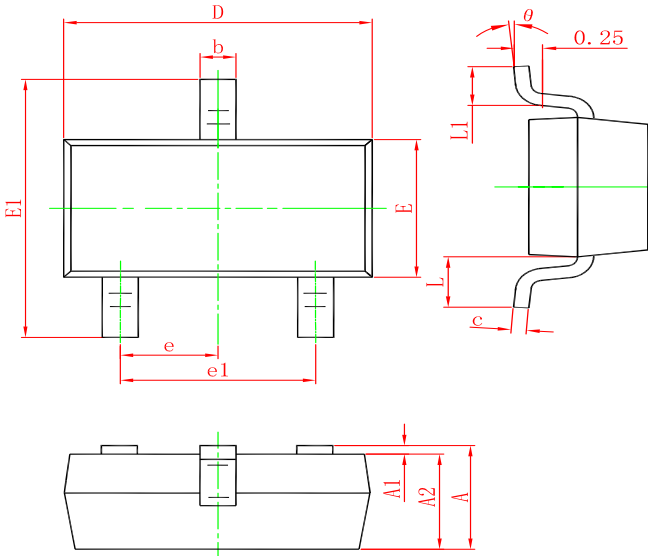

Symbol	Dimensions In Millimeters		Dimensions In Inches	
	Min.	Max.	Min.	Max.
A	0.900	1.150	0.035	0.045
A1	0.000	0.100	0.000	0.004
A2	0.900	1.050	0.035	0.041
b	0.300	0.500	0.012	0.020
c	0.080	0.150	0.003	0.006
D	2.800	3.000	0.110	0.118
E	1.200	1.400	0.047	0.055
E1	2.250	2.550	0.089	0.100
e	0.950 TYP.		0.037 TYP.	
e1	1.800	2.000	0.071	0.079
L	0.550 REF.		0.022 REF.	
L1	0.300	0.500	0.012	0.020
θ	0°	8°	0°	8°

Marking

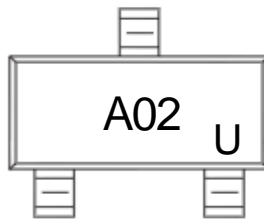

Ordering information

Order code	Package	Baseqty	Deliverymode
UMW SI2302A	SOT-23	3000	Tape and reel