



(2.54 mm) .100"

THROUGH-HOLE .025" SQ POST HEADER

Board Mates:

SSW, SSQ, SSM, ESW, ESQ, BCS, BSW, CES, SLW

Cable Mates:

IDSD, IDSS

SPECIFICATIONS

For complete specifications see www.samtec.com?TSW or www.samtec.com?HTSW

Insulator Material:

TSW: PBT
HTSW: Natural LCP

Terminal Material:

Phosphor Bronze

Plating:

Au or Sn over 50 μ" (1.27 μm) Ni

Operating Temp Range:

-55 °C to +125 °C with Gold

-55 °C to +105 °C with Tin

Voltage Rating:

550 VAC mated with SSW;

500 VAC mated with BCS or ESQ;

450 VAC -RA/-RE mated with BCS or SSM

400 VAC mated with CES

RoHS Compliant: Yes

Lead-Free Solderable:

HTSW: Yes

TSW: No, Lead Wave Only

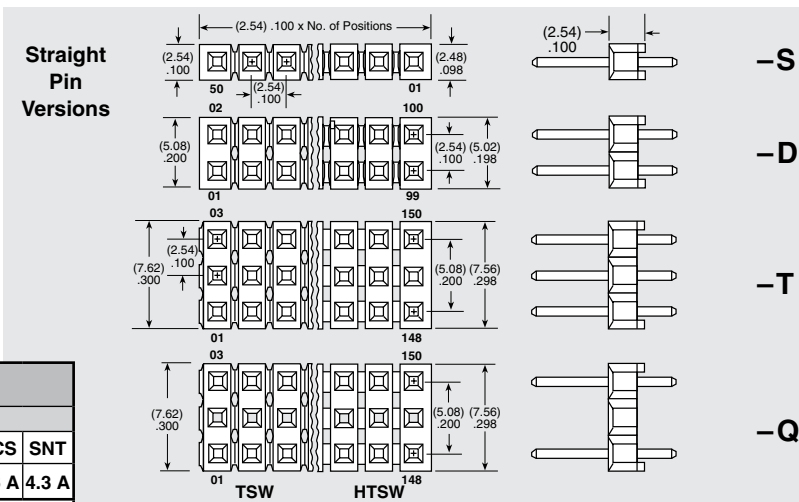
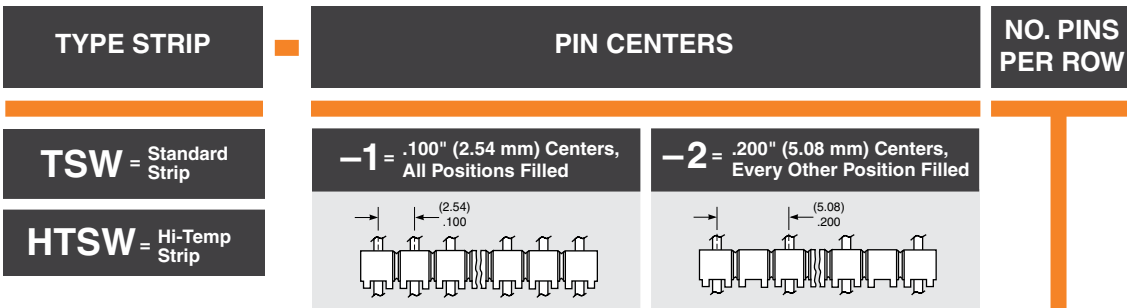

01 thru 50
= .100" (2.54 mm) Center Version

CURRENT RATING (PER PIN)						
TSW mated with						
ESW	SSW	SLW	SSQ	SSM	BCS	SNT
5.2 A	5.7 A	5.2 A	6.3 A	5.2 A	4.6 A	4.3 A

2 POSITIONS POWERED

RECOGNITIONS

For complete scope of recognitions see www.samtec.com/quality

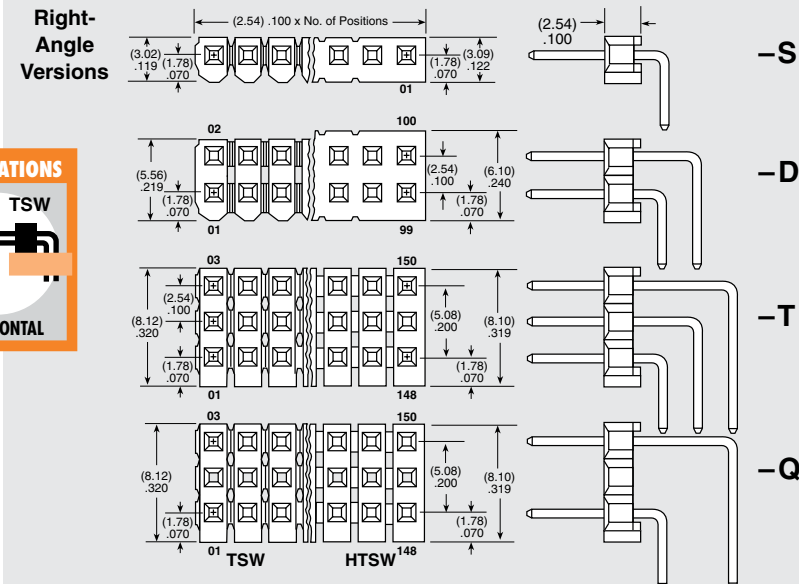
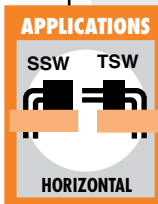

02 thru 25
= .200" (5.08 mm) Center Version

ALSO AVAILABLE (MOQ Required)

- Other platings

Note:
Some lengths, styles and options are non-standard, non-returnable.

Due to technical progress, all designs, specifications and components are subject to change without notice.

WWW.SAMTEC.COM

All parts within this catalog are built to Samtec's specifications.

Customer specific requirements must be approved by Samtec and identified in a Samtec customer-specific drawing to apply.

TSW-109-10-F-D-RA

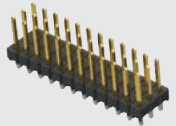

TSW-112-07-F-T

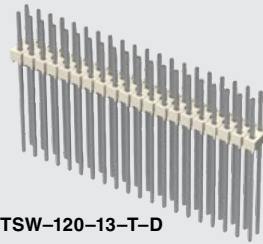
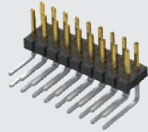

HTSW-120-13-T-D



TSW-114-16-G-S-RE

TSW, HTSW SERIES

LEAD STYLE

PLATING OPTION

ROW OPTION

OTHER OPTIONS

-F

= Gold flash on post, Matte Tin on tail

-L

= 10 μ" (0.25 μm) Gold on post, Matte Tin on tail

-G

= 10 μ" (0.25 μm) Gold on post, Gold flash on balance

-T

= Matte Tin

-S

= Single Row

-D

= Double Row

-T

= Triple Row

-Q

= Double Row (5.08 mm) .200" row space

-RA or -RE

= Right-angle

-NA

= Right-angle (using straight body for coplanar mating with SSW-RA series)

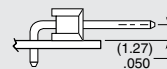

(1.27) .050

-LL

= Locking Lead

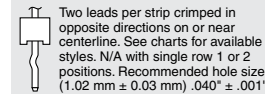

Two leads per strip crimped in opposite directions on or near centerline. See charts for available styles. N/A with single row 1 or 2 positions. Recommended hole size (1.02 mm ± 0.03 mm) .040" ± .001"

-LC

= Locking Clip (Styles -08 thru -13 & -22 only)

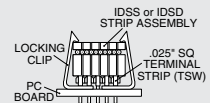

IDSS or IDSD STRIP ASSEMBLY
LOCKING CLIP
PC BOARD
.025" SQ TERMINAL STRIP (TSW)
Requires 4 pin minimum (NA with -T, -Q, -RA or -RE)

-LA

= -RA Option with -LL Option

-"XXX"

= Polarized Position

OTHER SOLUTIONS

- Elevated Right-angle option
- Shunts

Straight Pin Versions

(Specify "LEAD STYLE" from chart)

STYLE	A	B	C
* -05	(3.30) .130	(8.51) .335	(2.67) .105
* -06	(2.41) .095	(7.62) .300	(2.67) .105
* -07	(2.54) .100	(10.92) .430	
* -08	(5.08) .200	(13.46) .530	
* -09	(10.16) .400	(18.54) .730	(5.84) .230
* -10	(12.70) .500	(21.08) .830	
* -11	(15.24) .600	(23.62) .930	
* -12	(17.78) .700	(26.16) .1.030	
* -13	(22.86) .900	(31.24) .1.230	
* -14	(2.79) .110	(13.46) .530	(8.13) .320
* -15		(18.54) .730	(13.21) .520
* -16	(7.87) .310		(8.13) .320
* -17	(2.79) .110	(21.08) .830	(15.74) .620

* Available with -LL (Locking Lead) Option

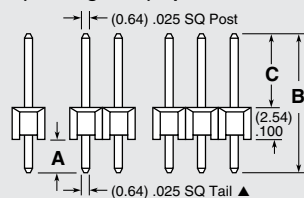

Specify -07 for best mate with IDXX Series IDC Cable

STYLE	A	B	C
* -18		(23.62) .930	(18.29) .720
* -19	(2.79) .110	(26.16) .1.030	(20.83) .820
* -20		(31.24) .1.230	(25.91) .1.020
* -21		(36.32) .1.430	(30.99) .1.220
* -22	(7.62) .300	(16.00) .630	(5.84) .230
* -23	(2.92) .115	(11.30) .445	
* -24		(12.15) .480	(6.73) .265
* -25	(5.33) .210	(16.00) .630	(8.13) .320
* -26	(3.20) .126	(11.58) .456	
* -27	(25.40) .1.000	(33.78) .1.330	(5.84) .230
* -28	(20.32) .800	(28.70) .1.130	
* -29	(23.11) .910	(33.78) .1.330	(8.13) .320
* -30	(18.03) .710	(28.70) .1.130	
* -41	(0.89) .035	(9.27) .365	(5.84) .230
* -42	(1.27) .050	(11.94) .470	(8.13) .320

+ Style -41 & -42 available with HTSW only.

▲ Except: Style -26 (0.46) .018 DIA Tail

Right-Angle Versions

(Specify "LEAD STYLE" from chart and select -RA or -RE from other options)

-RA LEAD STYLE	SINGLE (-S)		DOUBLE (-D)	TRIPLE (-T & -Q)	
	A	C	A	A	
* -08	(2.29) .090		(2.29) .090	(2.29) .090	
* -09	(7.37) .290		(7.37) .290	(7.37) .290	
* -10	(9.91) .390	(5.84) .230	(9.91) .390	(9.91) .390	
* -11	(12.45) .490		(12.45) .490	(12.45) .490	
* -12	(14.99) .590		(14.99) .590	(14.99) .590	
* -13	(20.07) .790		(20.07) .790	N/A	
* -16	(5.08) .200	(8.13) .320	(5.08) .200	(5.08) .200	
* -21	(25.15) .990	(5.84) .230	N/A	N/A	
* -22	(4.83) .190		(4.83) .190	(4.83) .190	
* -25	(2.54) .100	(8.13) .320	(2.54) .100	(2.54) .100	
* -27	(22.61) .890	(5.84) .230	N/A	N/A	
* -28	(17.53) .690		(17.53) .690	(17.53) .690	
* -29	(20.32) .800	(8.13) .320	N/A	N/A	
* -30	(15.24) .600		(15.24) .600	(15.24) .600	

-RE LEAD STYLE	SINGLE A	C
* -09	(4.83) .190	
* -10	(7.37) .290	
* -11	(9.91) .390	(5.84) .230
* -12	(12.45) .490	
* -13	(17.53) .690	
* -16	(2.54) .100	(8.13) .320
* -21	(22.61) .890	
* -22	(2.29) .090	(5.84) .230
* -27	(20.07) .790	
* -28	(14.99) .590	

* Available with -LA (Locking Lead) Option

LEAD STYLE	B
-RA	(1.52) .060
-RE	(4.06) .160

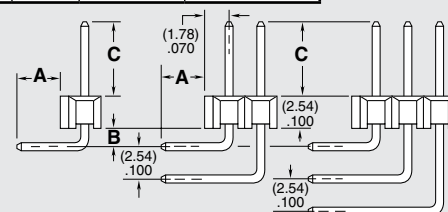

Due to technical progress, all designs, specifications and components are subject to change without notice.

WWW.SAMTEC.COM

All parts within this catalog are built to Samtec's specifications. Customer specific requirements must be approved by Samtec and identified in a Samtec customer-specific drawing to apply.

Mouser Electronics

Authorized Distributor

Click to View Pricing, Inventory, Delivery & Lifecycle Information:

[Samtec:](#)

[TSW-105-23-T-D](#)