

# Rectangular Package Discrete LED YELLOW, 2 x 3 mm, Low Current

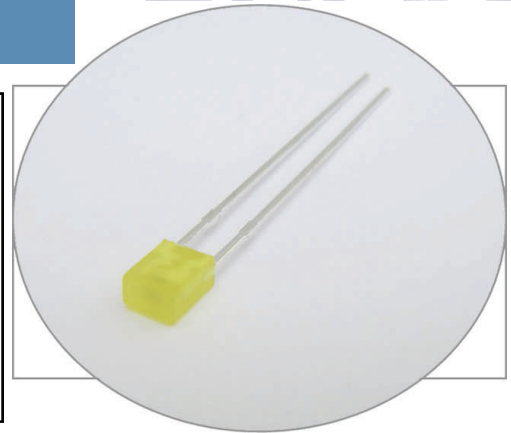

## R3YDL

- ◆ Rectangular Package
- ◆ RoHS Compliant
- ◆ Diffused Lens
- ◆ Available in Standard Lead Frame style
- ◆ Ideal for Status Indication and Bar Graph Displays
- ◆ 2 mA Low Operating Current
- ◆ Recommended for Bivar H-480C holder assemblies



Bivar Rectangular 2 x 3mm Package Low Current LED is special binned at 2 mA and is ideal for those applications where lower power budget is required such as solar or battery-powered portable devices. The rectangular package makes it ideal for creating bar graph displays when arranged in linear LED arrays. Bivar offers diffused LED lens for uniform light output. The Standard Lead frame LED is ideal for vertical spacer assemblies and Right Angle Holder assemblies that require lead bends.

Part Number	Material	Emitted Color	Peak. Wavelength $\lambda_p$ (nm) TYP.	Lens Appearance	Viewing Angle
R3YDL	GaAsP/GaP	YELLOW	590nm	Yellow Diffused	100°

## Outline Dimensions

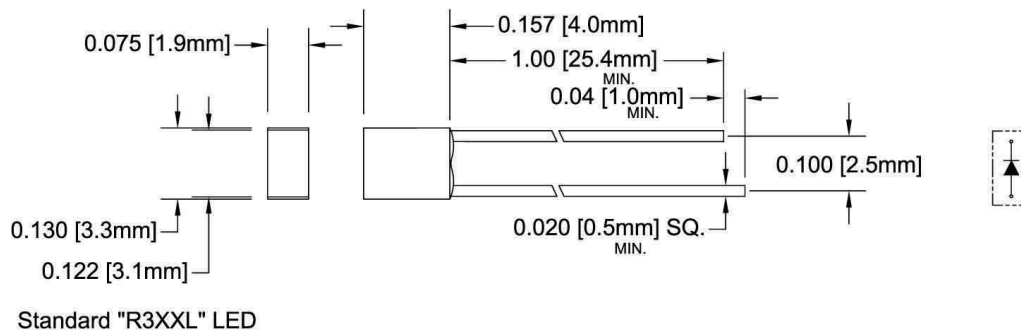

### Recommended Mounting

Hole Size =  $\varnothing.032^{+.003}_{-.002}$

### Outline Drawings Notes:

1. All dimensions are in inches [millimeters].
2. Standard tolerance:  $\pm 0.010$ " unless otherwise noted.
3. Tolerance of overall epoxy outline:  $\pm 0.020$ " unless otherwise noted.
4. Epoxy meniscus may extend to 0.060" max.

## Part Number Designation

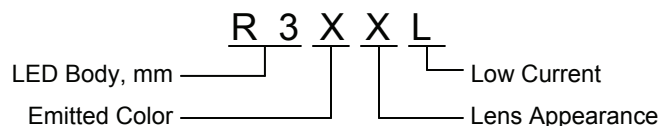

Bivar reserves the right to make changes at any time without notice.

# Rectangular Package Discrete LED YELLOW, 2 x 3 mm, Low Current



## Absolute Maximum Ratings

T<sub>A</sub> = 25°C unless otherwise noted

Power Dissipation	10 mW
Forward Current ( DC )	7 mA
Peak Forward Current <sup>1</sup>	/ mA
Reverse Voltage	5 V
Operating Temperature Range	-25 ~ +85°C
Storage Temperature Range	-30 ~ +100°C
Lead Soldering Temperature ( 3 mm from the base of the epoxy bulb ) <sup>2</sup>	260°C

Notes: 1. 10% Duty Cycle, Pulse Width ≤ 0.1 msec.    2. Solder time less than 5 seconds at temperature extreme.

## Electrical / Optical Characteristics

T<sub>A</sub> = 25°C & I<sub>F</sub> = 2 mA unless otherwise noted

Part Number	Forward Voltage (V) <sup>1</sup>			Recommend Forward Current (mA)			Reverse Current (μA)	Dominant Wavelength (nm) <sup>2</sup>			Luminous Intensity I <sub>v</sub> (mcd)			Viewing Angle 2 Θ ½ (deg)
	MIN	TYP	MAX	MIN	TYP	MAX	MAX	MIN	TYP	MAX	MIN	TYP	MAX	TYP
R3YDL	/	2.0	2.8	/	2	/	/	/	/	/	/	0.3	/	100

Notes: 1. Tolerance of forward voltage : ±0.05V.    2. Tolerance of dominant wavelength : ±1.0nm.

Bivar reserves the right to make changes at any time without notice.

# Rectangular Package Discrete LED YELLOW, 2 x 3 mm, Low Current



## Typical Electrical / Optical Characteristics

$T_A = 25^\circ\text{C}$  unless otherwise noted

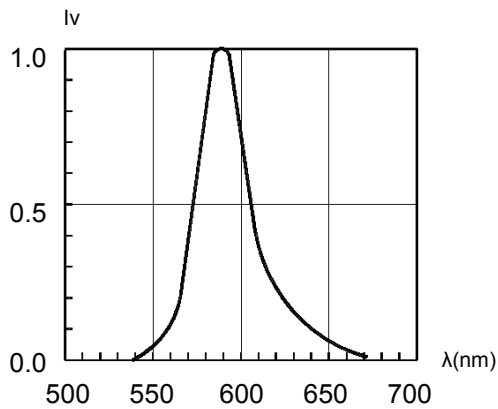

Fig. 1 Relative Luminous Intensity vs. Wavelength

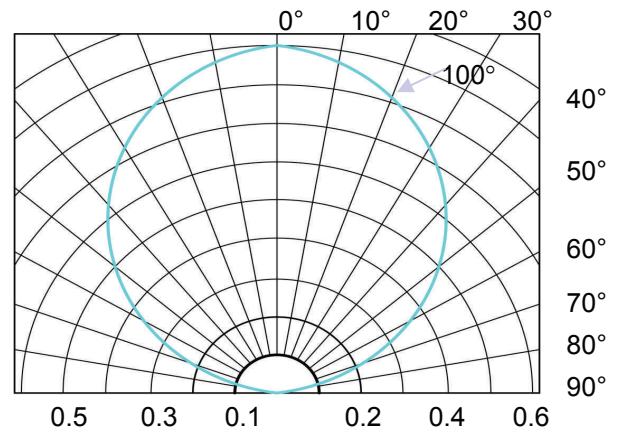

Fig. 2 Directivity Radiation Diagram

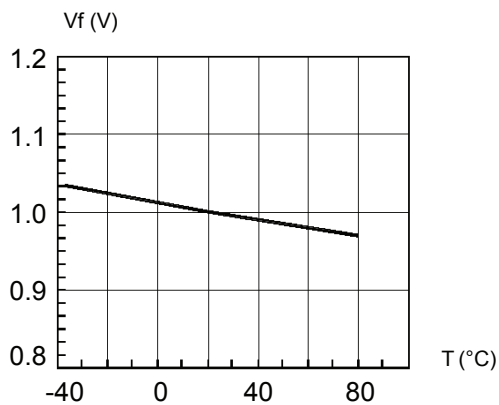

Fig. 3 Forward Voltage vs. Temperature

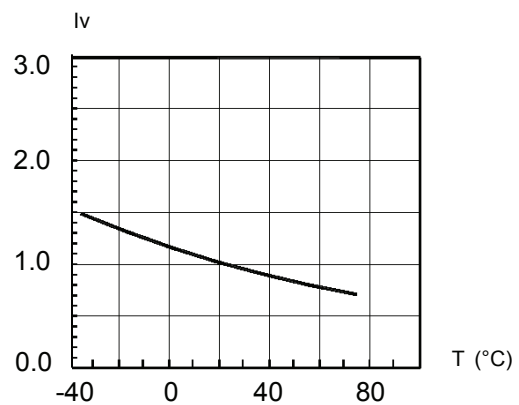

Fig. 4 Relative Luminous Intensity vs. Temperature

Bivar reserves the right to make changes at any time without notice.

# Rectangular Package Discrete LED YELLOW, 2 x 3 mm, Low Current



## Recommended Soldering Conditions

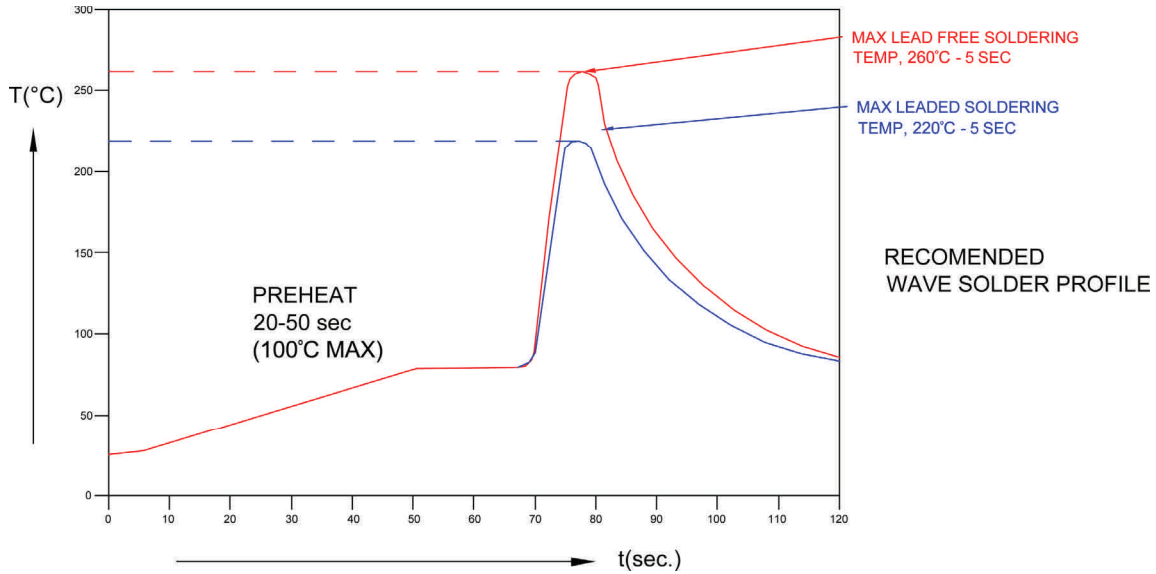

Recommended Lead Free Wave Soldering Profile	
Preheat Temperature: 100°C Max.	Peak Temperature: 260°C Max.
Preheat Time: 20 ~ 50 Seconds	Solder Time Above 217°C: 5 Seconds Max.
Note: Turn off top heater at preheat to prevent the lamp body directly exposed to the heat source.	

## Packaging and Labeling Plan

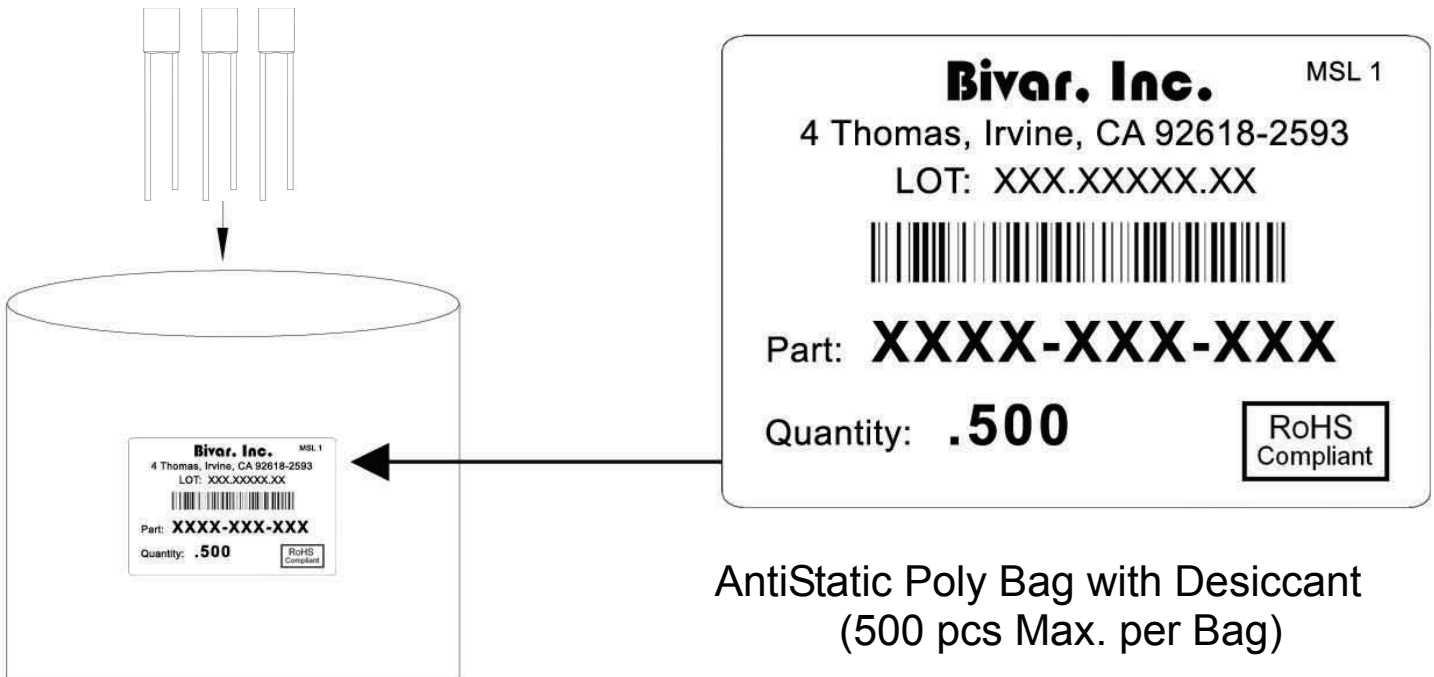

AntiStatic Poly Bag with Desiccant  
(500 pcs Max. per Bag)

Bivar reserves the right to make changes at any time without notice.

# Mouser Electronics

Authorized Distributor

Click to View Pricing, Inventory, Delivery & Lifecycle Information:

[BIVAR:](#)

[R3YDL](#)