

**STRAIGHT BULKHEAD PLUG CRIMP TYPE
CABLE 2.6/50 D**

R128.084.827
SERIES BMA COM

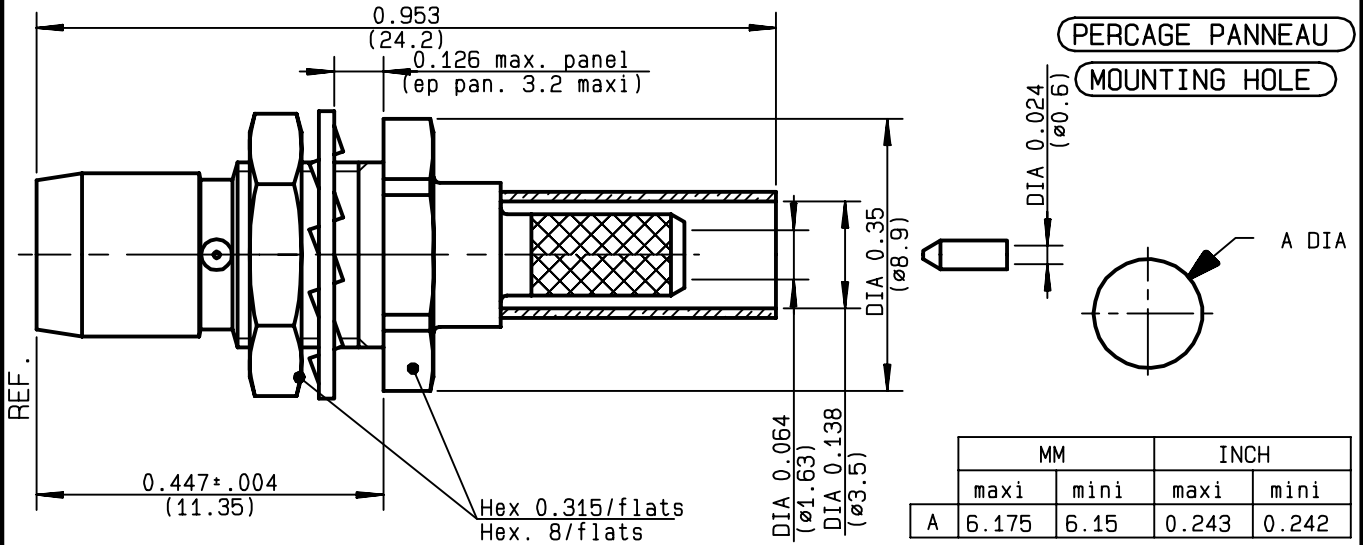

NOMINAL IMPEDANCE	50	Ω
FREQUENCY RANGE	0-12.4	GHz
TEMPERATURE RATING	-65/+125	$^{\circ}\text{C}$
V.S.W.R	1.15 +	.02 x F(GHz)Maxi
RF INSERTION LOSS	0.03	\sqrt{F} (GHz) dB Maxi
VOLTAGE RATING	350	Veff Maxi
DIELECTRIC WITHSTANDING VOLTAGE	1000	Veff Mini
INSULATION RESISTANCE	5000	M Ω Mini
HERMETIC SEAL	NA	Atm.cm ³ /s
LEAKAGE (pressurized only)	NA	
MECHANICAL DURABILITY	500	Cycles
WEIGHT	3.8	gr
SPECIFICATION		

CABLES : **K02252D**
RD 316

OTHERS CHARACTERISTICS

CABLE RETENTION	110	N Mini
CENTER CONTACT RETENTION		
Axial force - mating end	18	N Mini
Axial force - opposite end	18	N Mini
Torque	NA	cm.N Mini
RECOMMENDED TORQUES		
Mating	NA	cm.N
Panel nut	150	cm.N
Clamp nut	NA	cm.N

CONNECTOR PARTS	MATERIALS	FINISH	(all values are given in micrometers)
BODY	BRASS	BBR 2	
OUTER CONTACT			
CENTER CONTACT	BRONZE	GOLD 1.3 OVER COPPER 2	
INSULATOR	PTFE	-	
GASKET		-	
OTHERS PIECES	BRASS	BBR 2	

ISSUE 9926A01	CREATION DATE 01/10/1996	FILE PART-NUMBER EPC96-06
-------------------------	------------------------------------	-------------------------------------



BAFFERT

The information given here is subject to change without notice.
Design changes may be in order to improve the product .

Connect to the future



R128.084.827

ISSUE 9926A01 SERIES BMA COM

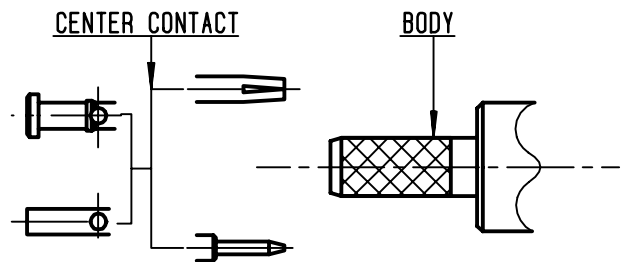
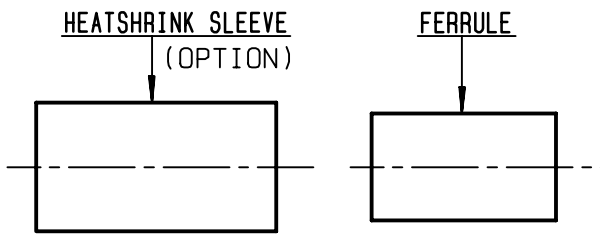

①

Slide ferrule and heatshrink sleeve onto cable .
 (OPTION - R280 637 020)
 Strip the cable
 -

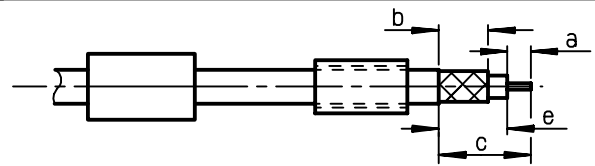

Stripping	a	b	c	d	e
inch	0.059	0.256	0.421	0	0.362
mm	1.5	6.5	10.7		9.2

②

Slide center contact on until it bottoms against cable dielectric .
 Solder center contact .
 Clean soldered area .
 -
 -

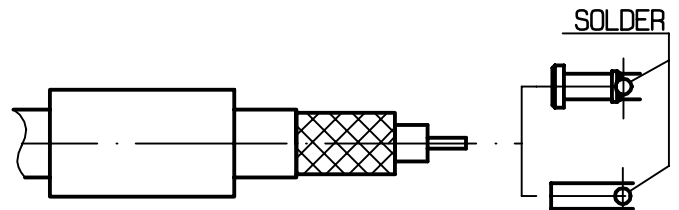

③

Fan the braid .
 Slide cable into body until it bottoms against insulator .
 Slide ferrule over the braid .
 (In direction F)

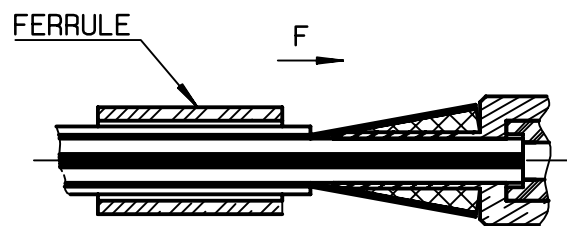

④

Crimp the ferrule with crimping tool R 282 271 000 (Hex. : 3.84mm) or crimping tool R 282 293 000 (M22520/5-01) + dies R 282 235 037 (M22520/5-37)
 Cut the excess of braid if necessary
 Slide sleeve over ferrule and heatshrink in place (OPTION)
 -
 -

Shrink the heatshrink sleeve

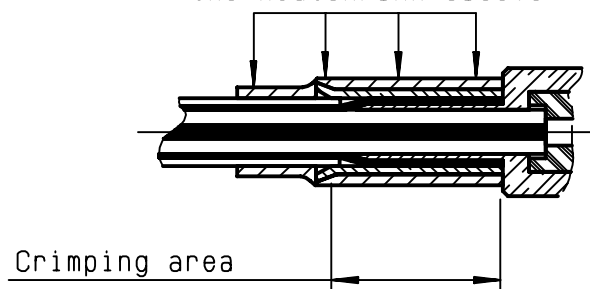

Mouser Electronics

Authorized Distributor

Click to View Pricing, Inventory, Delivery & Lifecycle Information:

Radial:

[R128084827](#) [R128084827W](#)