

325/326 Series Lead-Free 3AB, Slo-Blo® Fuse



Agency Approvals

| Agency | Agency File Number | Ampere Range |
|--------|---|--|
| | E10480 | 0.250A - 10A |
| | E10480 | 12A - 30A |
| | 29862 | 0.250A - 30A |
| | Cartridge: NBK 030805-E10480A NBK 030805-E10480C NBK 030805-E10480E NBK 260106-JP1021A Leaded: NBK 030805-E10480B NBK 030805-E10480D NBK 030805-E10480F NBK 260106-JP1021B | 1A-3.2A 4A-5A 6.25A-15A 20A-30A 1A-3.2A 4A-5A 6.25A-15A 20A-30A |
| | SU05001-5010 SU05001-5011 SU05001-5012 SU05001-6006 SU05001-6007 | 7-10A 12A, 15A 20A 2.8A-3.2A 2.5A |
| | T 50239752 01 | *12A/*15A/*20A |
| | N/A | 0.010A - 30A |

* Approved for cartridge version only

Description

The 3AB Slo-Blo® Fuse with ceramic body construction permits higher interrupting ratings and voltage ratings. Ideal for applications where high current loads are expected.

Features

- In accordance with UL Standard 248-14
- Available in cartridge and axial lead format and with various forming dimensions
- RoHS compliant and Lead-free

Applications

Used as supplementary protection in appliance or utilization equipment to provide individual protection for components or internal circuits.

Electrical Characteristics for Series

| % of Ampere Rating | Ampere Rating | Opening Time |
|--------------------|---------------|-----------------------------|
| 100% | 0.010A – 30A | 4 hours, Minimum |
| 135% | 0.010A – 30A | 1 hour, Maximum |
| 200% | 0.010A – 3.2A | 5 sec., Min., 30 sec., Max. |
| | 4A – 30A | 5 sec., Min., 60 sec., Max. |

Additional Information



**Datasheet
325 Series**



**Resources
325 Series**



**Samples
325 Series**



**Accessories
325 Series**



**Datasheet
326 Series**



**Resources
326 Series**









**Samples
326 Series**



**Accessories
326 Series**

For recommended fuse accessories for this product series, see '[Recommended Accessories](#)' section.

Electrical Characteristic Specifications by Item

| Amp Code | Ampere Rating (A) | Voltage Rating (V) | Interrupting Rating | Nominal Cold Resistance (Ohms) | Nominal Melting I ² t (A ² sec) | Agency Approvals | | | | | | |
|----------|-------------------|--------------------|---|--------------------------------|---|---|---|---|---|---|---|---|
| | | | | | |  |  |  |  |  |  |  |
| .010 | 0.01 | 250 | 100A@250Vac | 3324.8000 | 0.00013 | | | | | x | | |
| .031 | 0.031 | 250 | | 332.5000 | 0.0110 | | | | | x | | |
| .062 | 0.062 | 250 | | 91.7000 | 0.0276 | | | | | x | | |
| .100 | 0.1 | 250 | | 33.5500 | 0.0870 | | | | | x | | |
| .125 | 0.125 | 250 | | 22.4500 | 0.100 | | | | | x | | |
| .150 | 0.15 | 250 | | 15.4500 | 0.143 | | | | | x | | |
| .175 | 0.175 | 250 | | 8.9200 | 0.350 | | | | | x | | |
| .187 | 0.187 | 250 | | 7.7250 | 0.330 | | | | | x | | |
| .200 | 0.2 | 250 | | 6.7700 | 0.316 | | | | | x | | |
| .250 | 0.25 | 250 | | 4.4300 | 0.804 | | | x | x | x | | |
| .300 | 0.3 | 250 | 3.2200 | 1.230 | | | x | x | x | | | |
| .375 | 0.375 | 250 | 2.1550 | 1.20 | | | x | x | x | | | |
| .400 | 0.4 | 250 | 1.9350 | 1.33 | | | x | x | x | | | |
| .500 | 0.5 | 250 | 1.3000 | 4.80 | | | x | x | x | | | |
| .600 | 0.6 | 250 | 0.9495 | 3.90 | | | x | x | x | | | |
| .700 | 0.7 | 250 | 0.7215 | 6.42 | | | x | x | x | | | |
| .750 | 0.75 | 250 | 0.6410 | 13.00 | | | x | x | x | | | |
| .800 | 0.8 | 250 | 0.5725 | 8.20 | | | x | x | x | | | |
| 001. | 1 | 250 | 0.3890 | 16.3 | x | | x | x | x | | | |
| 01.2 | 1.2 | 250 | 0.2860 | 22.0 | x | | x | x | x | | | |
| 1.25 | 1.25 | 250 | 0.2680 | 40.0 | x | | x | x | x | | | |
| 01.5 | 1.5 | 250 | 0.1975 | 59.7 | x | | x | x | x | | | |
| 01.6 | 1.6 | 250 | 0.1760 | 66.0 | x | | x | x | x | | | |
| 002. | 2 | 250 | 0.1210 | 118.0 | x | | x | x | x | | | |
| 02.5 | 2.5 | 250 | 0.0835 | 185.0 | x | | x | x | x | | x | |
| 02.8 | 2.8 | 250 | 0.0695 | 232.0 | x | | x | x | x | | x | |
| 003. | 3 | 250 | 0.0605 | 200.0 | x | | x | x | x | | x | |
| 03.2 | 3.2 | 250 | 100A@250Vac 10KA@125Vac | 0.0539 | 214.0 | x | | x | x | x | | x |
| 004. | 4 | 250 | 400A@250Vac 10KA@125Vac 10KA@125Vdc | 0.0761 | 9.71 | x | | x | x | x | | |
| 005. | 5 | 250 | | 0.0522 | 25.0 | x | | x | x | x | | |
| 6.25 | 6.25 | 250 | | 0.0346 | 60.4 | x | | x | x | x | | |
| 007. | 7 | 250 | | 0.0227 | 47.3 | x | | x | x | x | | x |
| 008. | 8 | 250 | | 0.0193 | 67.1 | x | | x | x | x | | x |
| 010. | 10 | 250 | | 0.0132 | 137 | x | | x | x | x | | x |
| 012. | 12 | 250 | 400A@250Vac 10KA@125Vac 600A@125Vdc | 0.0067 | 129 | x | x | x | | x | x*** | x |
| 012.* | 12 | 250 | 1500A@250Vac | 0.0011 | 618 | | x | x | | x | | |
| 015. | 15 | 250 | 400A@250Vac 10KA@125Vac 600A@125Vdc | 0.0050 | 245 | x | x | x | | x | x*** | x |
| 015.* | 15 | 250 | 1500A@250Vac | 0.0083 | 760 | | x | x | | x | | |
| 020. | 20 | 250 | 400A@250Vac 10KA@125Vac 600A@125Vdc | 0.0034 | 575 | x | x | x | | x | x*** | x |
| 020.* | 20 | 250 | 1500A@250Vac | 0.0042 | 2500 | | x | x | | x | | |
| 025.** | 25 | 250 | 1500A@250Vac | 0.0032 | 4682 | | x | | | x | | |
| 025. | 25 | 250 | 400A@250Vac 10KA@60Vdc | 0.0024 | 1030 | x | x | x | | x | | |
| 030. | 30 | 250 | 600A@125Vdc | 0.0019 | 1690 | x | x | x | | x | | |

*Higher I²t version available. Please add suffix "D" to part numbers. For instance, 0325020.MXDP, 0326020.MXDP
 I²t test at 10x rated current.

**Higher I²t version available. Please add suffix "W" to part numbers. For instance, 0325025.MXWP

***Approved for cartridge versions only, and interrupting rating is 400A@125Vac and 400A@250Vac

Temperature Re-rating Curve

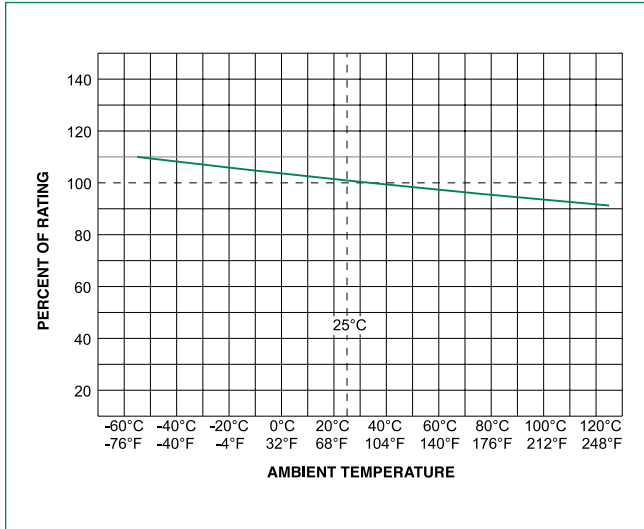

Note:
Rerating depicted in this curve is in addition to the standard derating of 25% for continuous operation.

Average Time Current Curves

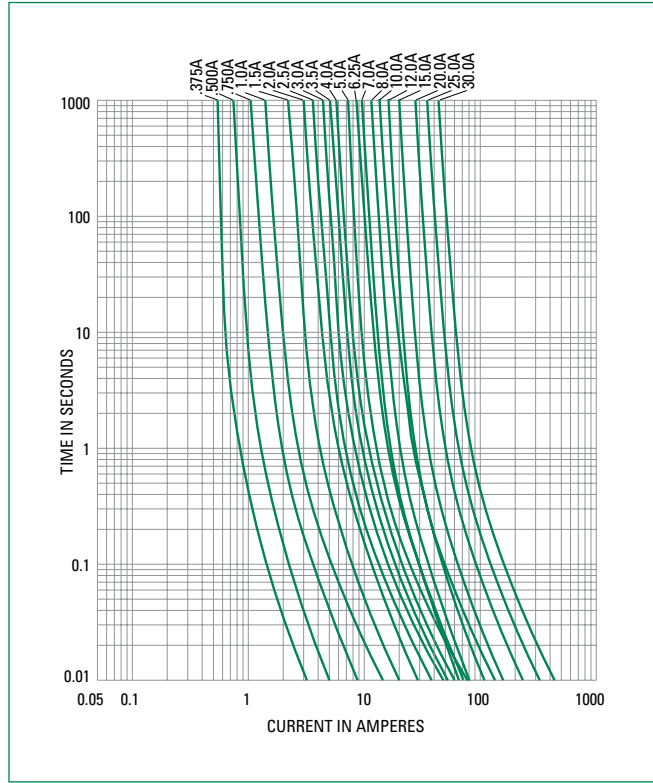

Soldering Parameters - Wave Soldering

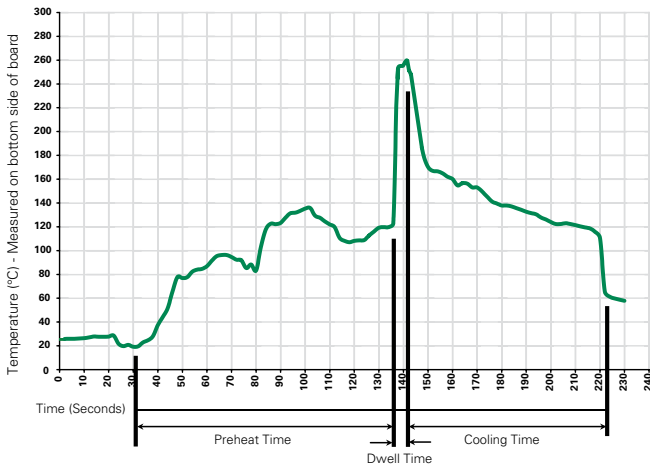

Recommended Process Parameters:

| Wave Parameter | Lead-Free Recommendation |
|--|-----------------------------------|
| Preheat: (Depends on Flux Activation Temperature) | (Typical Industry Recommendation) |
| Temperature Minimum: | 100°C |
| Temperature Maximum: | 150°C |
| Preheat Time: | 60-180 seconds |
| Solder Pot Temperature: | 260°C Maximum |
| Solder Dwell Time: | 2-5 seconds |

Recommended Hand-Solder Parameters:

Solder Iron Temperature: 350°C +/- 5°C
Heating Time: 5 seconds max.

Note: These devices are not recommended for IR or Convection Reflow process.

Product Characteristics

| | |
|--------------------------|---|
| Materials | Body: Ceramic Cap: Nickel-plated brass Leads: Tin-plated Copper |
| Terminal Strength | MIL-STD-202, Method 211, Test Condition A |
| Solderability | MIL-STD-202 Method 208 |
| Product Marking | Cap1: Brand logo, current and voltage ratings Cap2: Series and agency approval marks |

| | |
|------------------------------|--|
| Operating Temperature | -55°C to +125°C |
| Thermal Shock | MIL-STD-202, Method 107, Test Condition B: (5 cycles - 65°C to 125°C) |
| Vibration: | MIL-STD-202, Method 201 |
| Humidity | MIL-STD-202, Method 103, Test Condition A: High RH (95%) and Elevated temperature (40°C) for 240 hours |
| Salt Spray | MIL-STD-202, Method 101, Test Condition B |

Dimensions

Measurements displayed in millimeters (inches)

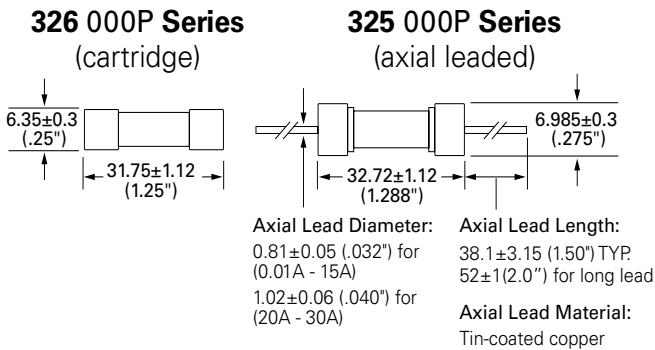

Part Numbering System

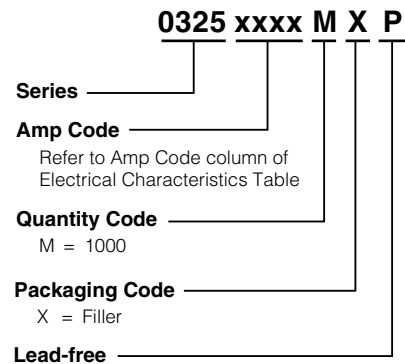

Packaging

| Packaging Option | Packaging Specification | Quantity | Quantity & Packaging Code | Taping Width |
|-------------------|-------------------------|----------|---------------------------|--------------|
| 325 Series | | | | |
| Bulk | N/A | 5 | VX | N/A |
| Bulk | N/A | 100 | HX | N/A |
| Bulk | N/A | 1000 | MX | N/A |
| Bulk | N/A | 1000 | MX52 (long lead) | N/A |
| Bulk | N/A | 1000 | MX52L (long lead) | N/A |
| Bulk | N/A | 1000 | MXD | N/A |
| Bulk | N/A | 1000 | MXF31 | N/A |
| Bulk | N/A | 1000 | MXW | N/A |
| 326 Series | | | | |
| Bulk | N/A | 5 | VX | N/A |
| Bulk | N/A | 100 | HX | N/A |
| Bulk | N/A | 1000 | MX | N/A |
| Bulk | N/A | 1000 | MXCC | N/A |
| Bulk | N/A | 1000 | MXD | N/A |

Recommended Accessories

| Accessory Type | Series | Description | Max Application Voltage | Max Application Amperage |
|----------------|------------------------|---|-------------------------|--------------------------|
| Holder | 155100 | Twist-Lock In-Line Fuseholder | 32 | 20 |
| | 342 | Traditional Panel Mount Fuseholder | 250 | 20 |
| | 346 | Panel Mount Flip-Top Shock-Safe Fuseholder | 250 | 15 |
| | 345 | Shock-Safe Fuseholder with PC Mount, Solder Mount and Panel Mount options | 250 | 20 |
| Block | 354 | Low Profile OMNI-BLOK® Fuse Block | 600 | 30 |
| | 359 | High Current Screw Terminal Fuse Block | | 30 |
| Clip | 122 | High Current Traditional PC Board Fuse Clip | 1000 | 30 |
| | 101 | Rivet/Eyelet Type Fuse Clip | 1000 | 15 |

Notes:

- Do not use in applications above rating.
- Please refer to fuseholder data sheet for specific re-rating information.
- Please contact Littelfuse for applications greater than the max voltage and amperage shown.

Disclaimer Notice - Information furnished is believed to be accurate and reliable. However, users should independently evaluate the suitability of and test each product selected for their own applications. Littelfuse products are not designed for, and may not be used in, all applications. Read complete Disclaimer Notice at: www.littelfuse.com/disclaimer-electronics.