

APPROVED: \_\_\_\_\_

DATE: \_\_\_\_\_ TITLE: \_\_\_\_\_

Rev	AWO #	Description	Date	Appr
-		RELEASED	10/25/18	

Pin	Signal Name	Mating Sequence	Pin	Signal Name	Mating Sequence
A1	GND	First	B12	GND	First
A2	SSTXp1	Second	B11	SSRXp1	Second
A3	SSTXn1	Second	B10	SSRXn1	Second
A4	V <sub>BUS</sub>	First	B9	V <sub>BUS</sub>	First
A5	CC1	Second	B8	SBU2	Second
A6	Dp1	Second	B7	Dn2	Second
A7	Dn1	Second	B6	Dp2	Second
A8	SBU1	Second	B5	CC2	Second
A9	V <sub>BUS</sub>	First	B4	V <sub>BUS</sub>	First
A10	SSRXn2	Second	B3	SSTXn2	Second
A11	SSRXp2	Second	B2	SSTXp2	Second
A12	GND	First	B1	GND	First
SHELL	GND		SHELL	GND	

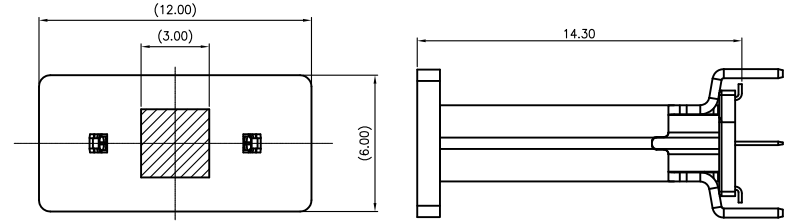
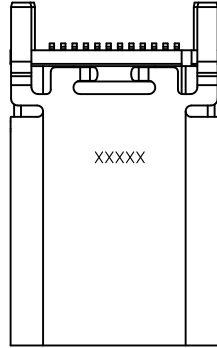

INCREASE THE DIAGRAMS OF CAP

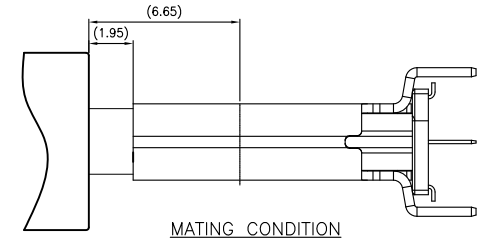
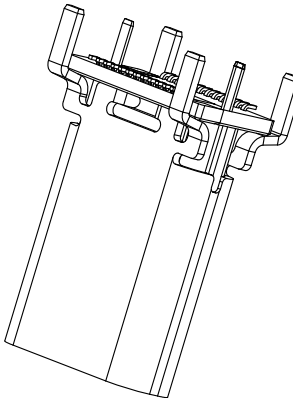
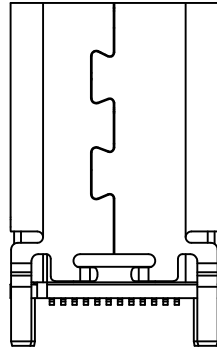
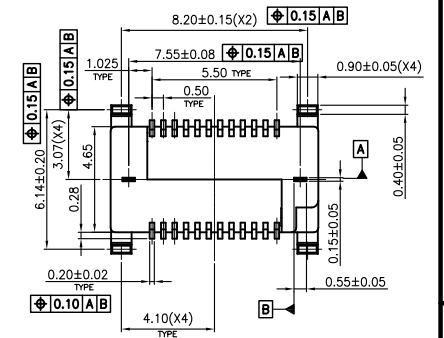
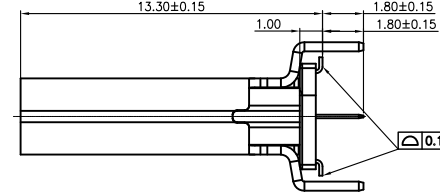
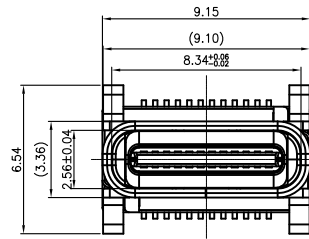

**SPECIFICATIONS:**

**Material:**  
 Insulator: Hi-temp thermoplastic, rated UL 94V-0  
 Insulator color: Black

Contacts: Copper alloy  
 Shell: Stainless steel, Nickel plated  
 Plating:

Gold flash over Nickel underplate on contact area,  
 Matte Tin over Nickel underplate on solder tails.

**Electrical:**  
 Current rating: 5 A (Power supply pin: A1, A4, A9, A12, B1, B4, B9, B12)  
 1.25 A (Vconn pin)  
 0.25 A (Other signal pin)

Contact resistance: 40 mohms max 10 mohms change after test,  
 measure @ 20mV, 100 mA

Insulation resistance: 100 Mohms min.  
 Dielectric withstanding: 100 VAC RMS

**Mechanical:**  
 Insertion force: 5~20N  
 Withdrawal force: 6~20N After test

Durability: 10,000 Cycles  
 Temperature Rating:  
 Operating temperature: -40°C to +85°C

**Environmental:**  
 Lead free, RoHS compliant.



PACKAGED ON TAPE & REEL

UNLESS OTHERWISE SPECIFIED ALL DIMENSIONS ARE MILLIMETERS TOLERANCES: EXCEPT AS NOTED	
MM	ANGLE
X. ± 0.50	± 2°
X.X ± 0.30	
X.XX ± 0.20	
X.XXX ± 0.10	

**ADAM TECH INTERCONNECTS** 909 Rahway Avenue,  
 Union, NJ 07083  
 Phone: 908-687-5000  
 Fax: 908-687-5710

APPROVALS		DATE
DRAWN	AY	10/25/18
CHECKED	CK	10/25/18
APPROVED		

TITLE UNIVERSAL SERIAL BUS, TYPE C 3.1, FEMALE, VERTICAL, SMT, BLACK INSULATOR, TAPE AND REEL		
SIZE X	PART NO. USB-C31-S-VT-CS4-BK-PP-T/R	REV. -
REF: S00296T	SCALE: NTS	SHEET 1 OF 1