

MAX3080–MAX3089

Fail-Safe, High-Speed (10Mbps), Slew-Rate-Limited RS-485/RS-422 Transceivers

General Description

The MAX3080–MAX3089 high-speed transceivers for RS-485/RS-422 communication contain one driver and one receiver. These devices feature fail-safe circuitry, which guarantees a logic-high receiver output when the receiver inputs are open or shorted. This means that the receiver output will be a logic high if all transmitters on a terminated bus are disabled (high impedance). The MAX3080/MAX3081/MAX3082 feature reduced slew-rate drivers that minimize EMI and reduce reflections caused by improperly terminated cables, allowing error-free data transmission up to 115kbps. The MAX3083/MAX3084/MAX3085 offer higher driver output slew-rate limits, allowing transmit speeds up to 500kbps. The MAX3086/MAX3087/MAX3088's driver slew rates are not limited, making transmit speeds up to 10Mbps possible. The MAX3089's slew rate is selectable between 115kbps, 500kbps, and 10Mbps by driving a selector pin with a single three-state driver.

These transceivers typically draw 375µA of supply current when unloaded, or when fully loaded with the drivers disabled.

All devices have a 1/8-unit-load receiver input impedance that allows up to 256 transceivers on the bus. The MAX3082/MAX3085/MAX3088 are intended for half-duplex communications, while the MAX3080/MAX3081/MAX3083/MAX3084/MAX3086/MAX3087 are intended for full-duplex communications. The MAX3089 is selectable between half-duplex and full-duplex operation. It also features independently programmable receiver and transmitter output phase via separate pins.

Next Generation Device Features

- ◆ **For Fault-Tolerant Applications:**
MAX3430: ±80V Fault-Protected, Fail-Safe, 1/4-Unit Load, +3.3V RS-485 Transceiver
- ◆ **For Low-Voltage Applications:**
MAX3362: +3.3V, High-Speed, RS-485/RS-422 Transceiver in a SOT23 Package
- ◆ **For Multiple Transceiver Applications:**
MAX3030E–MAX3033E: ±15kV ESD-Protected, +3.3V, Quad, RS-422 Transmitters
MAX3040–MAX3045: ±10kV ESD-Protected, Quad, +5V, RS-485/RS-422 Transmitters

Applications

RS-422/RS-485 Communications
 Level Translators
 Transceivers for EMI-Sensitive Applications
 Industrial-Control Local Area Networks

Ordering Information

PART	TEMP RANGE	PIN-PACKAGE
MAX3080CSD	0°C to +70°C	14 SO
MAX3080CPD	0°C to +70°C	14 Plastic DIP
MAX3080ESD	-40°C to +85°C	14 SO
MAX3080EPD	-40°C to +85°C	14 Plastic DIP

Ordering Information continued at end of data sheet.

Selection Table

Part	Half/Full Duplex	Data Rate (Mbps)	Slew Rate Limited	Low-Power Shutdown	Receiver/Driver Enable	Quiescent Current (µA)	Transceivers On Bus	Pin Count	Industry-Standard Pinout
MAX3080	Full	0.115	Yes	Yes	Yes	375	256	14	75180
MAX3081	Full	0.115	Yes	No	No	375	256	8	75179
MAX3082	Half	0.115	Yes	Yes	Yes	375	256	8	75176
MAX3083	Full	0.5	Yes	Yes	Yes	375	256	14	75180
MAX3084	Full	0.5	Yes	No	No	375	256	8	75179
MAX3085	Half	0.5	Yes	Yes	Yes	375	256	8	75176
MAX3086	Full	10	No	Yes	Yes	375	256	14	75180
MAX3087	Full	10	No	No	No	375	256	8	75179
MAX3088	Half	10	No	Yes	Yes	375	256	8	75176
MAX3089	Selectable	Selectable	Selectable	Yes	Yes	375	256	14	75180*

*Pin-compatible with 75180, with additional features implemented using pins 1, 6, 8, and 13.

For pricing, delivery, and ordering information, please contact Maxim Direct at 1-888-629-4642, or visit Maxim's website at www.maximintegrated.com.

MAX3080–MAX3089

Fail-Safe, High-Speed (10Mbps), Slew-Rate-Limited RS-485/RS-422 Transceivers

ABSOLUTE MAXIMUM RATINGS

Supply Voltage (V_{CC})+7V
 Control Input Voltage (RE, DE).....-0.3V to (V_{CC} + 0.3V)
 Special Input Voltage (H/F, SRL, TXP, RXP).....-0.3V to (V_{CC} + 0.3V)
 Driver Input Voltage (DI).....-0.3V to (V_{CC} + 0.3V)
 Driver Output Voltage (A, B, Y, Z).....±13V
 Receiver Input Voltage (A, B)±13V
 Receiver Input Voltage, Full Duplex (A, B)±25V
 Receiver Output Voltage (RO).....-0.3V to (V_{CC} + 0.3V)

Continuous Power Dissipation
 8-Pin Plastic DIP (derate 9.09mW/°C above +70°C) ...727mW
 8-Pin SO (derate 5.88mW/°C above +70°C).....471mW
 14-Pin Plastic DIP (derate 10.0mW/°C above +70°C)800mW
 14-Pin SO (derate 8.33mW/°C above +70°C).....667mW
 Operating Temperature Ranges
 MAX308_C_ _0°C to +70°C
 MAX308_E_ _-40°C to +85°C
 Storage Temperature Range-65°C to +150°C
 Lead Temperature (soldering, 10s)+300°C

Stresses beyond those listed under "Absolute Maximum Ratings" may cause permanent damage to the device. These are stress ratings only, and functional operation of the device at these or any other conditions beyond those indicated in the operational sections of the specifications is not implied. Exposure to absolute maximum rating conditions for extended periods may affect device reliability.

DC ELECTRICAL CHARACTERISTICS

(V_{CC} = +5V ±5%, T_A = T_{MIN} to T_{MAX}, unless otherwise noted. Typical values are at V_{CC} = +5V and T_A = +25°C.) (Note 1)

PARAMETER	SYMBOL	CONDITIONS	MIN	TYP	MAX	UNITS
DRIVER						
Differential Driver Output (no load)	V _{OD1}	Figure 5			5	V
Differential Driver Output	V _{OD2}	Figure 5, R = 50Ω (RS-422)	2.0			V
		Figure 5, R = 27Ω (RS-485)	1.5			
Change in Magnitude of Differential Output Voltage (Note 2)	ΔV _{OD}	Figure 5, R = 50Ω or R = 27Ω			0.2	V
Driver Common-Mode Output Voltage	V _{OC}	Figure 5, R = 50Ω or R = 27Ω			3	V
Change In Magnitude of Common-Mode Voltage (Note 2)	ΔV _{OC}	Figure 5, R = 50Ω or R = 27Ω			0.2	V
Input High Voltage	V _{IH1}	DE, DI, RE, H/F, TXP, RXP	2.0			V
Input Low Voltage	V _{IL1}	DE, DI, RE, H/F, TXP, RXP			0.8	V
DI Input Hysteresis	V _{HYS}	MAX3080–MAX3085, and MAX3089 with SRL = V _{CC} or unconnected		100		mV
SRL Input Current	I _{IN1}	DE, DI, RE			±2	μA
	I _{IN2}	H/F, TXP, RXP, internal pulldown	10		40	
Input High Voltage	V _{IH2}	SRL	V _{CC} - 0.8			V
Input Middle Voltage	V _{IM2}	SRL (Note 3)	0.4V _{CC}		0.6V _{CC}	V
Input Low Voltage	V _{IL2}	SRL			0.8	V
SRL Input Current	I _{IN3}	SRL = V _{CC}			75	μA
		SRL = GND (Note 3)	-75			
Input Current (A and B) Full Duplex	I _{IN4}	DE = GND, V _{CC} = GND or 5.25V	V _{IN} = 12V		125	μA
			V _{IN} = -7V		-75	
Output Leakage (Y and Z) Full Duplex	I _O	DE = GND, V _{CC} = GND or 5.25V	V _{IN} = 12V		125	μA
			V _{IN} = -7V	-100		
Driver Short-Circuit Output Current (Note 4)	V _{OD1}	-7V ≤ V _{OUT} ≤ V _{CC}	-250			mA
		0V ≤ V _{OUT} ≤ 12V			250	
		0V ≤ V _{OUT} ≤ V _{CC}	±25			

MAX3080–MAX3089

Fail-Safe, High-Speed (10Mbps), Slew-Rate-Limited RS-485/RS-422 Transceivers

DC ELECTRICAL CHARACTERISTICS (continued)

($V_{CC} = +5V \pm 5\%$, $T_A = T_{MIN}$ to T_{MAX} , unless otherwise noted. Typical values are at $V_{CC} = +5V$ and $T_A = +25^\circ C$.) (Note 1)

PARAMETER	SYMBOL	CONDITIONS	MIN	TYP	MAX	UNITS
RECEIVER						
Receiver Differential Threshold Voltage	V_{TH}	$-7V \leq V_{CM} \leq +12V$	-200	-125	-50	mV
Receiver Input Hysteresis	ΔV_{TH}			25		mV
Receiver Output High Voltage	V_{OH}	$I_O = -4mA, V_{ID} = -50mV$	$V_{CC} - 1.5$			V
Receiver Output Low Voltage	V_{OL}	$I_O = 4mA, V_{ID} = -200mV$			0.4	V
Three-State Output Current at Receiver	I_{OZR}	$0.4V \leq V_O \leq 2.4V$			± 1	μA
Receiver Input Resistance	R_{IN}	$-7V \leq V_{CM} \leq +12V$	96			$k\Omega$
Receiver Output Short-Circuit Current	I_{OSR}	$0V \leq V_{RO} \leq V_{CC}$	± 7		± 95	mA
SUPPLY CURRENT						
Supply Current	I_{CC}	No load, $\overline{RE} = DI = GND$ or V_{CC} , $SRL = V_{CC}$	$DE = V_{CC}$	430	900	μA
			$DE = GND$	375	600	
		No load, $\overline{RE} = DI = GND$ or V_{CC} , $SRL = GND$	$DE = V_{CC}$	475	1000	μA
			$DE = GND$	420	800	
Supply Current in Shutdown Mode	I_{SHDN}	$DE = GND, \overline{RE} = V_{CC}$		0.001	10	μA

Note 1: All currents into the device are positive; all currents out of the device are negative. All voltages are referred to device ground unless otherwise noted.

Note 2: ΔV_{OD} and ΔV_{OC} are the changes in V_{OD} and V_{OC} , respectively, when the DI input changes state.

Note 3: The SRL pin is internally biased to $V_{CC} / 2$ by a $100k\Omega / 100k\Omega$ resistor divider. It is guaranteed to be $V_{CC} / 2$ if left unconnected.

Note 4: Maximum current level applies to peak current just prior to foldback-current limiting; minimum current level applies during current limiting.

MAX3080–MAX3089

Fail-Safe, High-Speed (10Mbps), Slew-Rate-Limited RS-485/RS-422 Transceivers

SWITCHING CHARACTERISTICS—MAX3080–MAX3082, and MAX3089 with SRL = Unconnected

(V_{CC} = +5V ±5%, T_A = T_{MIN} to T_{MAX}, unless otherwise noted. Typical values are at V_{CC} = +5V and T_A = +25°C.)

PARAMETER	SYMBOL	CONDITIONS	MIN	TYP	MAX	UNITS
Driver Input to Output	t _{DPLH}	Figures 7 and 9, R _{DIFF} = 54Ω, C _{L1} = C _{L2} = 100pF	500	2030	2600	ns
	t _{DPHL}		500	2030	2600	
Driver Output Skew t _{DPLH} - t _{DPHL}	t _{DSKEW}	Figures 7 and 9, R _{DIFF} = 54Ω, C _{L1} = C _{L2} = 100pF		-3	±200	ns
Driver Rise or Fall Time	t _{DR} , t _{DF}	Figures 7 and 9, R _{DIFF} = 54Ω, C _{L1} = C _{L2} = 100pF	667	1320	2500	ns
Maximum Data Rate	f _{MAX}		115			kbps
Driver Enable to Output High	t _{DZH}	Figures 8 and 10, C _L = 100pF, S2 closed			3500	ns
Driver Enable to Output Low	t _{DZL}	Figures 8 and 10, C _L = 100pF, S1 closed			3500	ns
Driver Disable Time from Low	t _{DLZ}	Figures 8 and 10, C _L = 15pF, S1 closed			100	ns
Driver Disable Time from High	t _{DHZ}	Figures 8 and 10, C _L = 15pF, S2 closed			100	ns
Receiver Input to Output	t _{RPLH} , t _{RPHL}	Figures 11 and 13; V _{ID} ≥ 2.0V; rise and fall time of V _{ID} ≤ 15ns		127	200	ns
t _{RPLH} - t _{RPHL} Differential Receiver Skew	t _{RSKD}	Figures 11 and 13; V _{ID} ≥ 2.0V; rise and fall time of V _{ID} ≤ 15ns		3	±30	ns
Receiver Enable to Output Low	t _{RZL}	Figures 6 and 12, C _L = 100pF, S1 closed		20	50	ns
Receiver Enable to Output High	t _{RZH}	Figures 6 and 12, C _L = 100pF, S2 closed		20	50	ns
Receiver Disable Time from Low	t _{RLZ}	Figures 6 and 12, C _L = 100pF, S1 closed		20	50	ns
Receiver Disable Time from High	t _{RHZ}	Figures 6 and 12, C _L = 100pF, S2 closed		20	50	ns
Time to Shutdown	t _{SHDN}	(Note 5)	50	200	600	ns
Driver Enable from Shutdown to Output High	t _{DZH(SHDN)}	Figures 8 and 10, C _L = 15pF, S2 closed			6000	ns
Driver Enable from Shutdown to Output Low	t _{DZL(SHDN)}	Figures 8 and 10, C _L = 15pF, S1 closed			6000	ns
Receiver Enable from Shutdown to Output High	t _{RZH(SHDN)}	Figures 6 and 12, C _L = 100pF, S2 closed			3500	ns
Receiver Enable from Shutdown to Output Low	t _{RZL(SHDN)}	Figures 6 and 12, C _L = 100pF, S1 closed			3500	ns

MAX3080–MAX3089

Fail-Safe, High-Speed (10Mbps), Slew-Rate-Limited RS-485/RS-422 Transceivers

SWITCHING CHARACTERISTICS—MAX3083–MAX3085, and MAX3089 with SRL = V_{CC}

(V_{CC} = +5V ±5%, T_A = T_{MIN} to T_{MAX}, unless otherwise noted. Typical values are at V_{CC} = +5V and T_A = +25°C.)

PARAMETER	SYMBOL	CONDITIONS	MIN	TYP	MAX	UNITS
Driver Input to Output	t _{DPLH}	Figures 7 and 9, R _{DIFF} = 54Ω, C _{L1} = C _{L2} = 100pF	250	720	1000	ns
	t _{DPHL}		250	720	1000	
Driver Output Skew t _{DPLH} - t _{DPHL}	t _{DSKEW}	Figures 7 and 9, R _{DIFF} = 54Ω, C _{L1} = C _{L2} = 100pF		-3	±100	ns
Driver Rise or Fall Time	t _{DR} , t _{DF}	Figures 7 and 9, R _{DIFF} = 54Ω, C _{L1} = C _{L2} = 100pF	200	530	750	ns
Maximum Data Rate	f _{MAX}		500			kbps
Driver Enable to Output High	t _{DZH}	Figures 8 and 10, C _L = 100pF, S2 closed			2500	ns
Driver Enable to Output Low	t _{DZL}	Figures 8 and 10, C _L = 100pF, S1 closed			2500	ns
Driver Disable Time from Low	t _{DLZ}	Figures 8 and 10, C _L = 15pF, S1 closed			100	ns
Driver Disable Time from High	t _{DHZ}	Figures 8 and 10, C _L = 15pF, S2 closed			100	ns
Receiver Input to Output	t _{RPLH} , t _{RPHL}	Figures 11 and 13; V _{ID} ≥ 2.0V; rise and fall time of V _{ID} ≤ 15ns		127	200	ns
t _{RPLH} - t _{RPHL} Differential Receiver Skew	t _{RSKD}	Figures 11 and 13; V _{ID} ≥ 2.0V; rise and fall time of V _{ID} ≤ 15ns		3	±30	ns
Receiver Enable to Output Low	t _{RZL}	Figures 6 and 12, C _L = 100pF, S1 closed		20	50	ns
Receiver Enable to Output High	t _{RZH}	Figures 6 and 12, C _L = 100pF, S2 closed		20	50	ns
Receiver Disable Time from Low	t _{RLZ}	Figures 6 and 12, C _L = 100pF, S1 closed		20	50	ns
Receiver Disable Time from High	t _{RHZ}	Figures 6 and 12, C _L = 100pF, S2 closed		20	50	ns
Time to Shutdown	t _{SHDN}	(Note 5)	50	200	600	ns
Driver Enable from Shutdown to Output High	t _{DZH(SHDN)}	Figures 8 and 10, C _L = 15pF, S2 closed			4500	ns
Driver Enable from Shutdown to Output Low	t _{DZL(SHDN)}	Figures 8 and 10, C _L = 15pF, S1 closed			4500	ns
Receiver Enable from Shutdown to Output High	t _{RZH(SHDN)}	Figures 6 and 12, C _L = 100pF, S2 closed			3500	ns
Receiver Enable from Shutdown to Output Low	t _{RZL(SHDN)}	Figures 6 and 12, C _L = 100pF, S1 closed			3500	ns

MAX3080–MAX3089

Fail-Safe, High-Speed (10Mbps), Slew-Rate-Limited RS-485/RS-422 Transceivers

SWITCHING CHARACTERISTICS—MAX3086–MAX3088, and MAX3089 with SRL = GND

(V_{CC} = +5V ±5%, T_A = T_{MIN} to T_{MAX}, unless otherwise noted. Typical values are at V_{CC} = +5V and T_A = +25°C.)

PARAMETER	SYMBOL	CONDITIONS	MIN	TYP	MAX	UNITS
Driver Input to Output	t _{DPLH}	Figures 7 and 9, R _{DIFF} = 54Ω, C _{L1} = C _{L2} = 100pF		34	60	ns
	t _{DPHL}			34	60	
Driver Output Skew t _{DPLH} - t _{DPHL}	t _{DSKEW}	Figures 7 and 9, R _{DIFF} = 54Ω, C _{L1} = C _{L2} = 100pF		-2.5	±10	ns
Driver Rise or Fall Time	t _{DR} , t _{DF}	Figures 7 and 9, R _{DIFF} = 54Ω, C _{L1} = C _{L2} = 100pF		14	25	ns
Maximum Data Rate	f _{MAX}		10			Mbps
Driver Enable to Output High	t _{DZH}	Figures 8 and 10, C _L = 100pF, S2 closed			150	ns
Driver Enable to Output Low	t _{DZL}	Figures 8 and 10, C _L = 100pF, S1 closed			150	ns
Driver Disable Time from Low	t _{DLZ}	Figures 8 and 10, C _L = 15pF, S1 closed			100	ns
Driver Disable Time from High	t _{DHZ}	Figures 8 and 10, C _L = 15pF, S2 closed			100	ns
Receiver Input to Output	t _{RPLH} , t _{RPHL}	Figures 11 and 13; V _{ID} ≥ 2.0V; rise and fall time of V _{ID} ≤ 15ns		106	150	ns
t _{RPLH} - t _{RPHL} Differential Receiver Skew	t _{RSKD}	Figures 11 and 13; V _{ID} ≥ 2.0V; rise and fall time of V _{ID} ≤ 15ns		0	±10	ns
Receiver Enable to Output Low	t _{RZL}	Figures 6 and 12, C _L = 100pF, S1 closed		20	50	ns
Receiver Enable to Output High	t _{RZH}	Figures 6 and 12, C _L = 100pF, S2 closed		20	50	ns
Receiver Disable Time from Low	t _{RLZ}	Figures 6 and 12, C _L = 100pF, S1 closed		20	50	ns
Receiver Disable Time from High	t _{RHZ}	Figures 6 and 12, C _L = 100pF, S2 closed		20	50	ns
Time to Shutdown	t _{SHDN}	(Note 5)	50	200	600	ns
Driver Enable from Shutdown to Output High	t _{DZH(SHDN)}	Figures 8 and 10, C _L = 15pF, S2 closed			250	ns
Driver Enable from Shutdown to Output Low	t _{DZL(SHDN)}	Figures 8 and 10, C _L = 15pF, S1 closed			250	ns
Receiver Enable from Shutdown to Output High	t _{RZH(SHDN)}	Figures 6 and 12, C _L = 100pF, S2 closed			3500	ns
Receiver Enable from Shutdown to Output Low	t _{RZL(SHDN)}	Figures 6 and 12, C _L = 100pF, S1 closed			3500	ns

Note 5: The device is put into shutdown by bringing \overline{RE} high and DE low. If the enable inputs are in this state for less than 50ns, the device is guaranteed not to enter shutdown. If the enable inputs are in this state for at least 600ns, the device is guaranteed to have entered shutdown.

MAX3080–MAX3089

Fail-Safe, High-Speed (10Mbps), Slew-Rate-Limited RS-485/RS-422 Transceivers

Typical Operating Characteristics

($V_{CC} = +5V$, $T_A = +25^\circ C$, unless otherwise noted.)

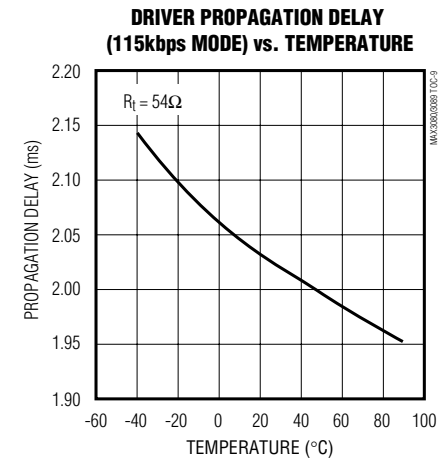
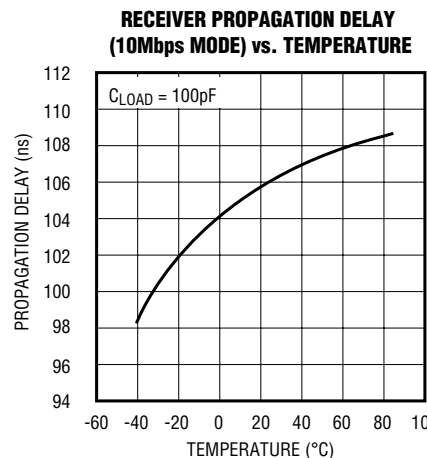
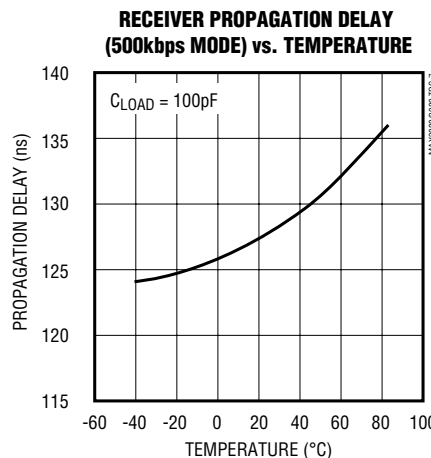
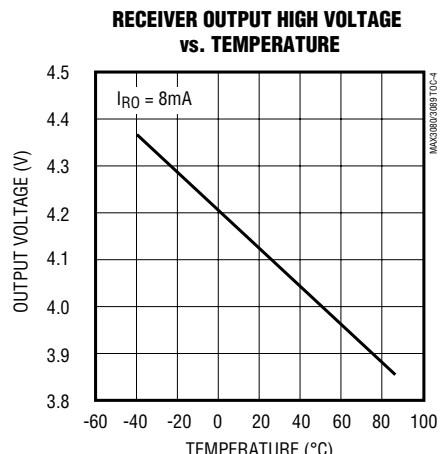
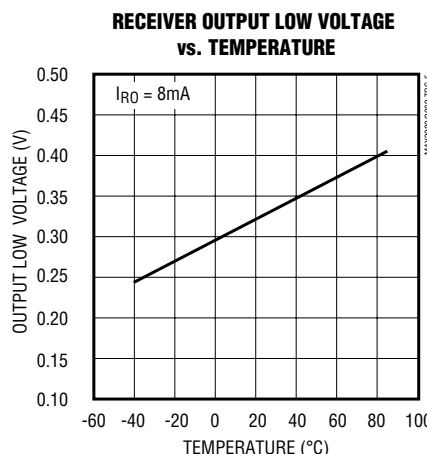
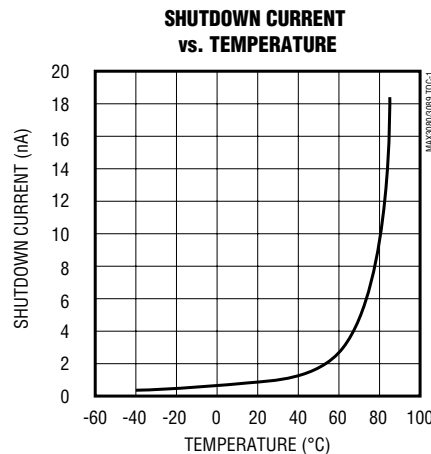
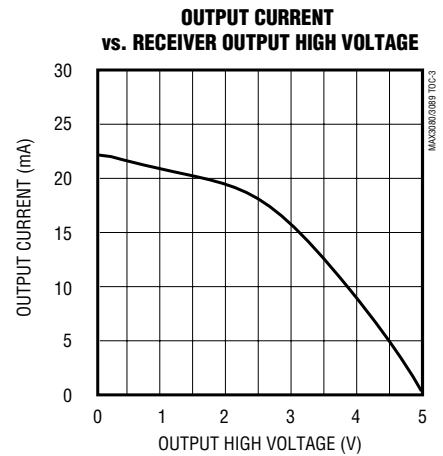
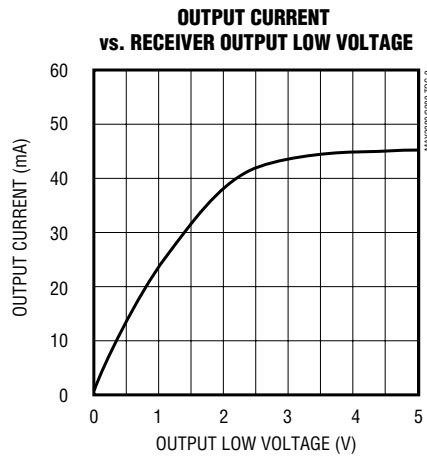
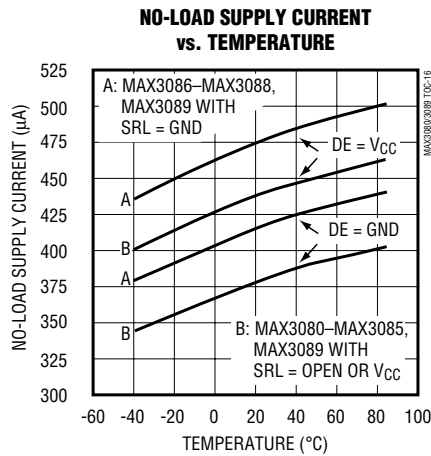

MAX3080-MAX3089

Fail-Safe, High-Speed (10Mbps), Slew-Rate-Limited RS-485/RS-422 Transceivers

Typical Operating Characteristics (continued)

($V_{CC} = +5V$, $T_A = +25^\circ C$, unless otherwise noted.)

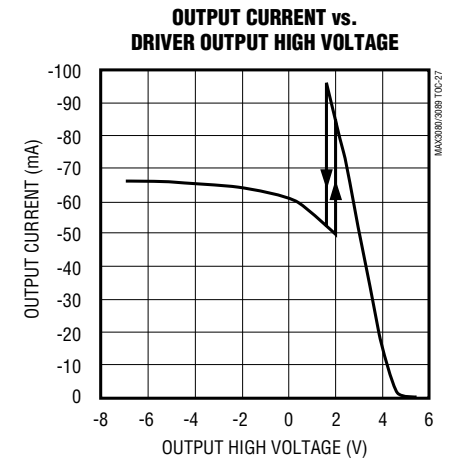
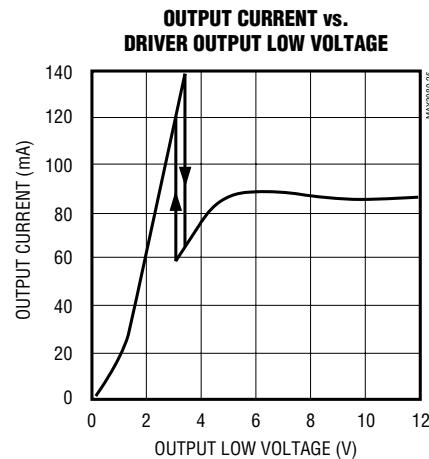
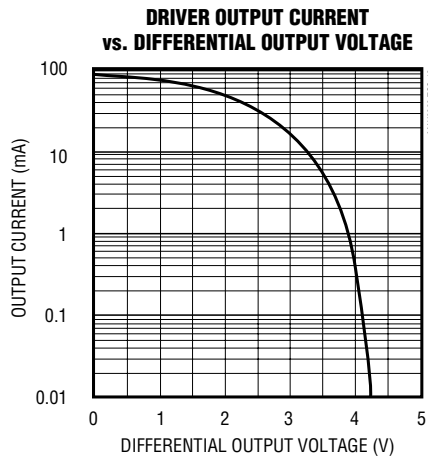
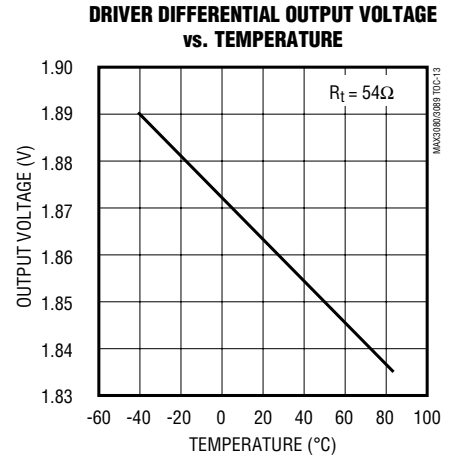
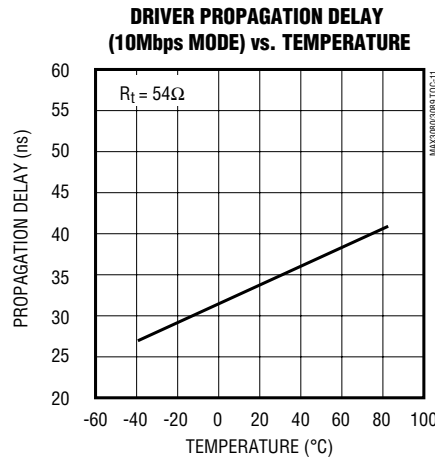
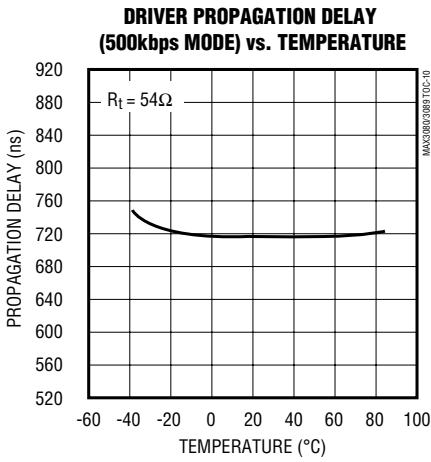

MAX3080–MAX3089

Fail-Safe, High-Speed (10Mbps), Slew-Rate-Limited RS-485/RS-422 Transceivers

Typical Operating Characteristics (continued)

($V_{CC} = +5V$, $T_A = +25^\circ C$, unless otherwise noted.)

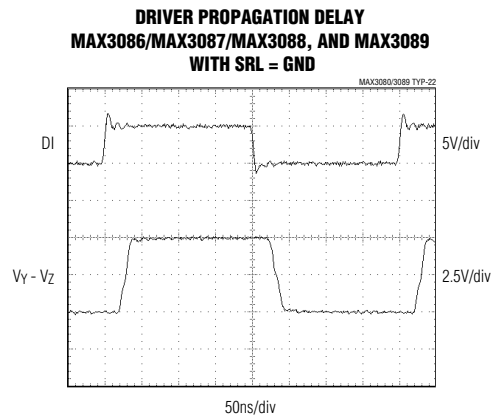
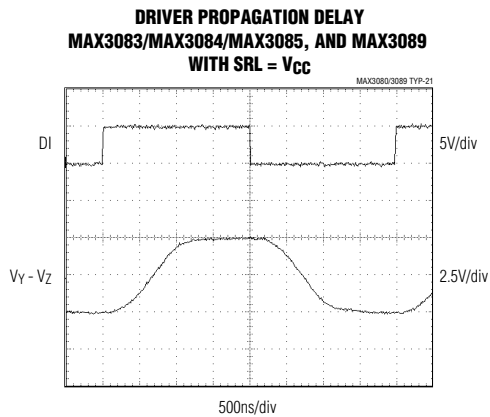
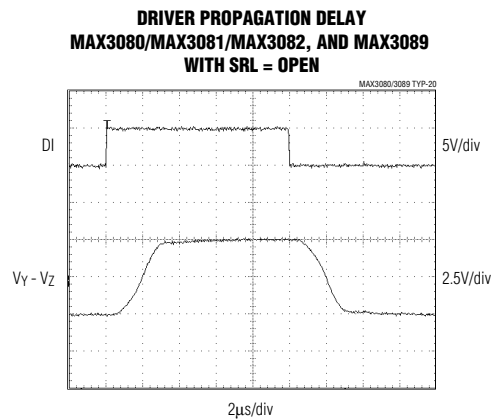
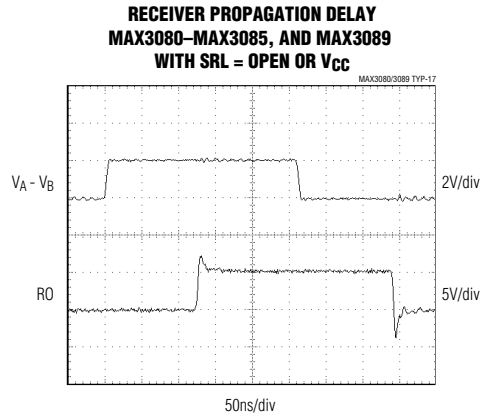
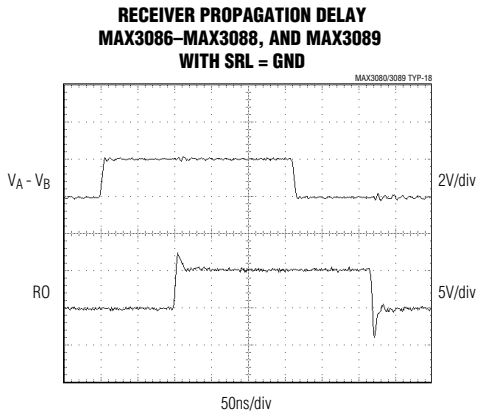

MAX3080–MAX3089

Fail-Safe, High-Speed (10Mbps), Slew-Rate-Limited RS-485/RS-422 Transceivers

Pin Description

PIN					NAME	FUNCTION
MAX3080 MAX3083 MAX3086	MAX3081 MAX3084 MAX3087	MAX3082 MAX3085 MAX3088	MAX3089			
FULL-DUPLEX DEVICES		HALF-DUPLEX DEVICES	FULL-DUPLEX MODE	HALF-DUPLEX MODE		
—	—	—	1	1	H/ \overline{F}	Half/Full-Duplex Selector Pin. Connect H/ \overline{F} to V _{CC} for half-duplex mode; connect to GND or leave unconnected for full-duplex mode.
2	2	1	2	2	RO	Receiver Output. When \overline{RE} is low and if A - B \geq -50mV, RO will be high; if A - B \leq -200mV, RO will be low.
3	—	2	3	3	\overline{RE}	Receiver Output Enable. Drive \overline{RE} low to enable RO; RO is high impedance when \overline{RE} is high. Drive \overline{RE} high and DE low to enter low-power shutdown mode.
4	—	3	4	4	DE	Driver Output Enable. Drive DE high to enable driver outputs. These outputs are high impedance when DE is low. Drive \overline{RE} high and DE low to enter low-power shutdown mode.
5	3	4	5	5	DI	Driver Input. With DE high, a low on DI forces noninverting output low and inverting output high. Similarly, a high on DI forces noninverting output high and inverting output low.
—	—	—	6	6	SRL	Slew-Rate-Limit Selector Pin. Connect SRL to GND for 10Mbps communication rate; connect to V _{CC} for 500kbps communication rate. Leave unconnected for 115kbps communication rate.
6, 7	4	5	7	7	GND	Ground
—	—	—	8	8	TXP	Transmitter Phase. Connect TXP to GND, or leave floating for normal transmitter phase/polarity. Connect to V _{CC} to invert the transmitter phase/polarity.
9	5	—	9	—	Y	Noninverting Driver Output
—	—	—	—	9	Y	Noninverting Receiver Input and Noninverting Driver Output*
10	6	—	10	—	Z	Inverting Driver Output
—	—	—	—	10	Z	Inverting Receiver Input and Inverting Driver Output*
11	7	—	11	—	B	Inverting Receiver Input
—	—	—	—	11	B	Receiver Input Resistors*
—	—	7	—	—	B	Inverting Receiver Input and Inverting Driver Output

MAX3080–MAX3089

Fail-Safe, High-Speed (10Mbps), Slew-Rate-Limited RS-485/RS-422 Transceivers

Pin Description (continued)

PIN					NAME	FUNCTION
MAX3080 MAX3083 MAX3086	MAX3081 MAX3084 MAX3087	MAX3082 MAX3085 MAX3088	MAX3089			
FULL-DUPLEX DEVICES		HALF-DUPLEX DEVICES	FULL-DUPLEX MODE	HALF-DUPLEX MODE		
12	8	—	12	—	A	Noninverting Receiver Input
—	—	—	—	12	A	Receiver Input Resistors*
—	—	6	—	—	A	Noninverting Receiver Input and Noninverting Driver Output
—	—	—	13	13	RXP	Receiver Phase. Connect RXP to GND, or leave unconnected for normal transmitter phase/polarity. Connect to V _{CC} to invert the receiver phase/polarity.
14	1	8	14	14	V _{CC}	Positive Supply; 4.75V ≤ V _{CC} ≤ 5.25V
1, 8, 13	—	—	—	—	N.C.	Not Connected. Not internally connected.

*(MAX3089 only.) In half-duplex mode, the driver outputs serve as receiver inputs. The full-duplex receiver inputs (A and B) will still have a 1/8-unit load, but are not connected to the receiver.

Function Tables

MAX3080/MAX3083/MAX3086

TRANSMITTING				
INPUTS			OUTPUTS	
\overline{RE}	DE	DI	Z	Y
X	1	1	0	1
X	1	0	1	0
0	0	X	High-Z	High-Z
1	0	X	Shutdown	

RECEIVING			
INPUTS			OUTPUT
\overline{RE}	DE	A-B	RO
0	X	≥ -0.05V	1
0	X	≤ -0.2V	0
0	X	Open/shorted	1
1	1	X	High-Z
1	0	X	Shutdown

X = Don't care

Shutdown mode, driver and receiver outputs high impedance

MAX3081/MAX3084/MAX3087

TRANSMITTING		
INPUT	OUTPUTS	
DI	Z	Y
1	0	1
0	1	0

RECEIVING	
INPUTS	OUTPUT
A-B	RO
≥ -0.05V	1
≤ -0.2V	0
Open/shorted	1

MAX3080–MAX3089

Fail-Safe, High-Speed (10Mbps), Slew-Rate-Limited RS-485/RS-422 Transceivers

Function Tables (continued)

MAX3082/MAX3085/MAX3088

TRANSMITTING				
INPUTS			OUTPUTS	
\overline{RE}	DE	DI	B/Z	A/Y
X	1	1	0	1
X	1	0	1	0
0	0	X	High-Z	High-Z
1	0	X	Shutdown	

RECEIVING			
INPUTS			OUTPUT
\overline{RE}	DE	A-B	RO
0	X	$\geq -0.05V$	1
0	X	$\leq -0.2V$	0
0	X	Open/shorted	1
1	1	X	High-Z
1	0	X	Shutdown

MAX3089

TRANSMITTING					
INPUTS				OUTPUTS	
TXP	\overline{RE}	DE	DI	Z	Y
0	X	1	1	0	1
0	X	1	0	1	0
1	X	1	1	1	0
1	X	1	0	0	1
X	0	0	X	High-Z	High-Z
X	1	0	X	Shutdown	

RECEIVING						
INPUTS						OUTPUT
H/ \overline{F}	RXP	\overline{RE}	DE	A-B	Y-Z	RO
0	0	0	X	$\geq -0.05V$	X	1
0	0	0	X	$\leq -0.2V$	X	0
0	1	0	X	$\geq -0.05V$	X	0
0	1	0	X	$\leq -0.2V$	X	1
1	0	0	0	X	$\geq -0.05V$	1
1	0	0	0	X	$\leq -0.2V$	0
1	1	0	0	X	$\geq -0.05V$	0
1	1	0	0	X	$\leq -0.2V$	1
0	0	0	X	Open/shorted	X	1
1	0	0	0	X	Open/shorted	1
0	1	0	X	Open/shorted	X	0
1	1	0	0	X	Open/shorted	0
X	X	1	1	X	X	High-Z
X	X	1	0	X	X	Shutdown

MAX3080–MAX3089

Fail-Safe, High-Speed (10Mbps), Slew-Rate-Limited RS-485/RS-422 Transceivers



Figure 1. MAX3080/MAX3083/MAX3086 Pin Configuration and Typical Full-Duplex Operating Circuit



Figure 2. MAX3081/MAX3084/MAX3087 Pin Configuration and Typical Full-Duplex Operating Circuit

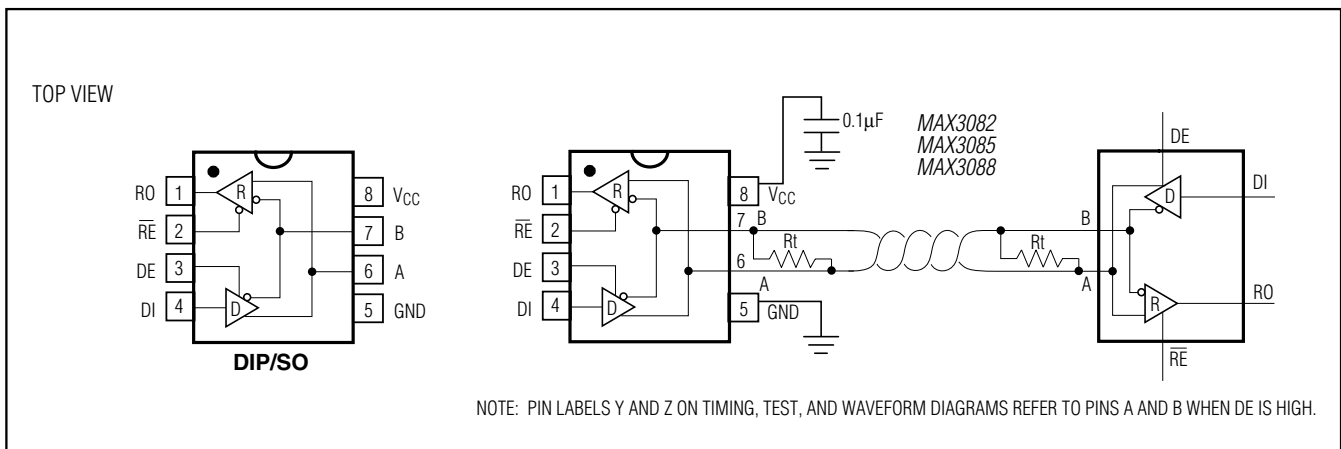

Figure 3. MAX3082/MAX3085/MAX3088 Pin Configuration and Typical Half-Duplex Operating Circuit

MAX3080–MAX3089

Fail-Safe, High-Speed (10Mbps), Slew-Rate-Limited RS-485/RS-422 Transceivers

Detailed Description

The MAX3080–MAX3089 high-speed transceivers for RS-485/RS-422 communication contain one driver and one receiver. These devices feature fail-safe circuitry, which guarantees a logic-high receiver output when the receiver inputs are open or shorted, or when they are connected to a terminated transmission line with all drivers disabled (see *Fail-Safe* section). The MAX3080/MAX3081/MAX3082 feature reduced slew-rate drivers that minimize EMI and reduce reflections caused by improperly terminated cables, allowing error-free data transmission up to 115kbps (see *Reduced EMI and Reflections* section). The MAX3083/MAX3084/MAX3085 offer higher driver output slew-rate limits, allowing transmit speeds up to 500kbps. The MAX3086/MAX3087/MAX3088's driver slew rates are not limited, making transmit speeds up to 10Mbps possible. The MAX3089's slew rate is selectable between 115kbps, 500kbps, and 10Mbps by driving a selector pin with a three-state driver.

The MAX3082/MAX3085/MAX3088 are half-duplex transceivers, while the MAX3080/MAX3081/MAX3083/MAX3084/MAX3086/MAX3087 are full-duplex transceivers. The MAX3089 is selectable between half- and full-duplex communication by driving a selector pin high or low, respectively.

All of these parts operate from a single +5V supply. Drivers are output short-circuit current limited. Thermal shutdown circuitry protects drivers against excessive power dissipation. When activated, the thermal shutdown circuitry places the driver outputs into a high-impedance state.

Receiver Input Filtering

The receivers of the MAX3080–MAX3085, and the MAX3089 when operating in 115kbps or 500kbps mode, incorporate input filtering in addition to input hysteresis. This filtering enhances noise immunity with differential signals that have very slow rise and fall times. Receiver propagation delay increases by 20% due to this filtering.

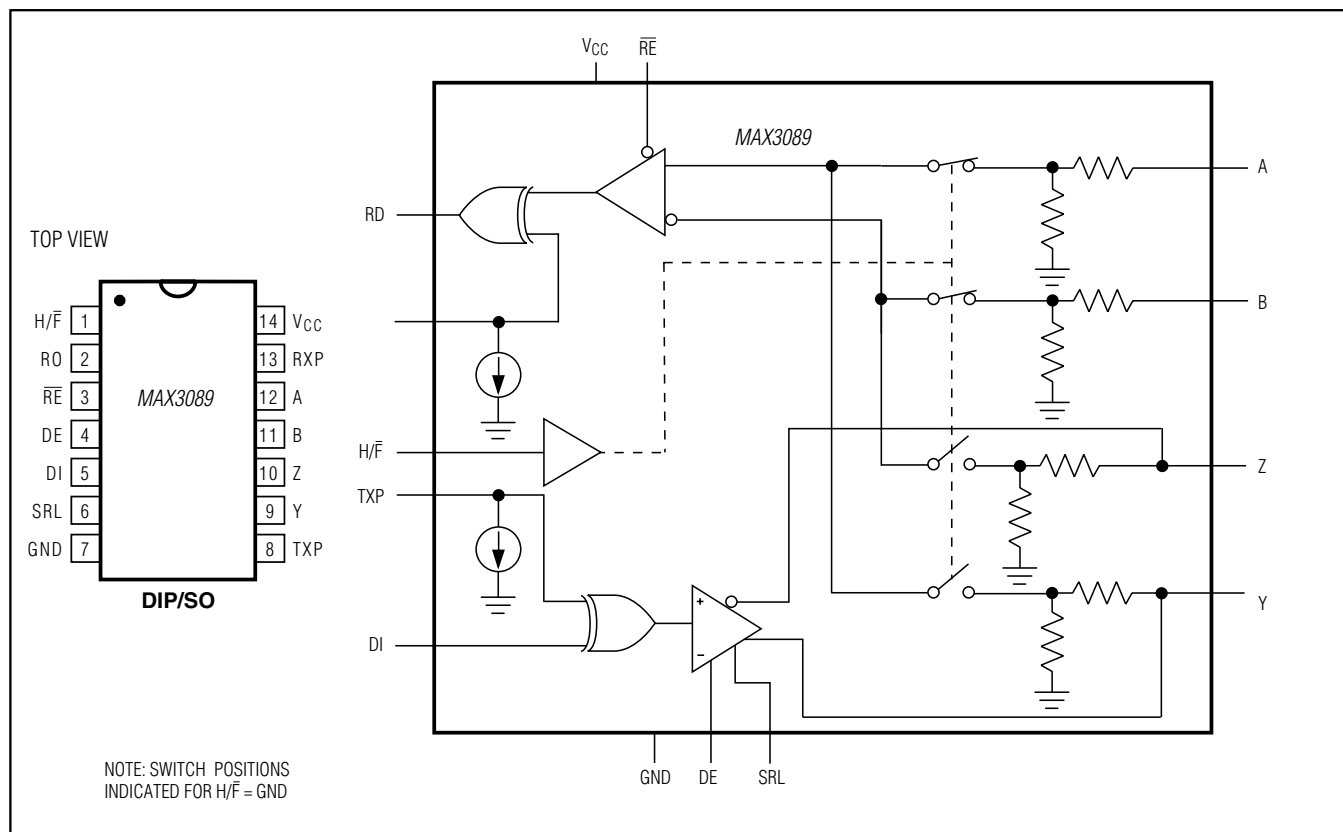

Figure 4. MAX3089 Pin Configuration and Functional Diagram

MAX3080–MAX3089

Fail-Safe, High-Speed (10Mbps), Slew-Rate-Limited RS-485/RS-422 Transceivers

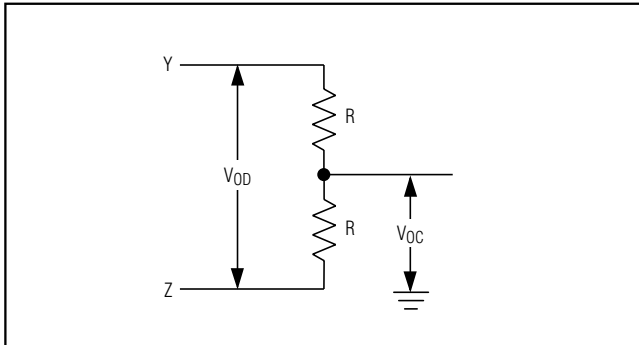

Figure 5. Driver DC Test Load

Fail-Safe

The MAX3080 family **guarantees** a logic-high receiver output when the receiver inputs are shorted or open, or when they are connected to a terminated transmission line with all drivers disabled. This is done by setting the receiver threshold between -50mV and -200mV . If the differential receiver input voltage (A-B) is greater than or equal to -50mV , RO is logic high. If A-B is less than or equal to -200mV , RO is logic low. In the case of a terminated bus with all transmitters disabled, the receiver's differential input voltage is pulled to 0V by the termination. With the receiver thresholds of the MAX3080 family, this results in a logic high with a 50mV minimum noise margin. Unlike previous fail-safe devices, the -50mV to -200mV threshold complies with the $\pm 200\text{mV}$ EIA/TIA-485 standard.

MAX3089 Programming

The MAX3089 has several programmable operating modes. Transmitter rise and fall times are programmable between 2500ns , 750ns , and 25ns , resulting in maximum data rates of 115kbps , 500kbps , and 10Mbps , respectively. To select the desired data rate, drive SRL to one of three possible states by using a three-state driver, by connecting it to V_{CC} or GND , or by leaving it unconnected. For 115kbps operation, set the three-state device in high-impedance mode or leave SRL unconnected. For 500kbps operation, drive SRL high or connect it to V_{CC} . For 10Mbps operation, drive SRL low or connect it to GND . SRL can be changed during operation without interrupting data communications.

Occasionally, twisted-pair lines are connected backward from normal orientation. The MAX3089 has two pins that invert the phase of the driver and the receiver to correct for this problem. For normal operation, drive

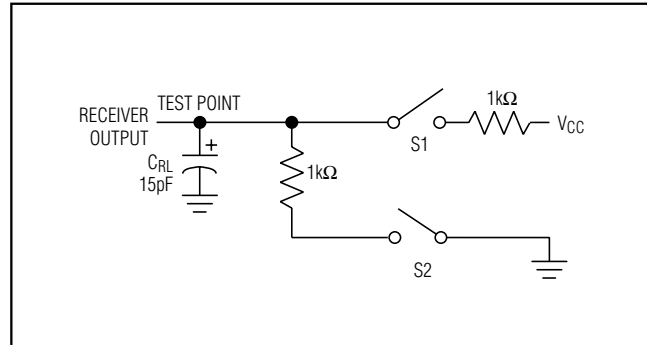

Figure 6. Receiver Enable/Disable Timing Test Load

TXP and RXP low, connect them to ground, or leave them unconnected (internal pulldown). To invert the driver phase, drive TXP high or connect it to V_{CC} . To invert the receiver phase, drive RXP high or connect it to V_{CC} . Note that the receiver threshold is positive when RXP is high.

The MAX3089 can operate in full- or half-duplex mode. Drive the H/\bar{F} pin low, leave it unconnected (internal pulldown), or connect it to GND for full-duplex operation, and drive it high for half-duplex operation. In full-duplex mode, the pin configuration of the driver and receiver is the same as that of a MAX3080 (Figure 4). In half-duplex mode, the receiver inputs are switched to the driver outputs, connecting outputs Y and Z to inputs A and B, respectively. In half-duplex mode, the internal full-duplex receiver input resistors are still connected to pins 11 and 12.

Applications Information

256 Transceivers on the Bus

The standard RS-485 receiver input impedance is $12\text{k}\Omega$ (one-unit load), and the standard driver can drive up to 32 unit loads. The MAX3080 family of transceivers have a $1/8$ -unit-load receiver input impedance ($96\text{k}\Omega$), allowing up to 256 transceivers to be connected in parallel on one communication line. Any combination of these devices and/or other RS-485 transceivers with a total of 32 unit loads or less can be connected to the line.

Reduced EMI and Reflections

The MAX3080–MAX3085, and MAX3089 with $SRL = V_{CC}$ or unconnected, are slew-rate limited, minimizing EMI and reducing reflections caused by improperly terminated cables. Figure 14 shows the driver output waveform and its Fourier analysis of a 20kHz signal transmitted by a MAX3086/MAX3087/MAX3088, and MAX3089 with $SRL = GND$. High-frequency harmonic

MAX3080-MAX3089

Fail-Safe, High-Speed (10Mbps), Slew-Rate-Limited RS-485/RS-422 Transceivers



Figure 7. Driver Timing Test Circuit



Figure 8. Driver Enable/Disable Timing Test Load



Figure 9. Driver Propagation Delays



Figure 10. Driver Enable and Disable Times (except MAX3081/MAX3084/MAX3087)



Figure 11. Receiver Propagation Delays



Figure 12. Receiver Enable and Disable Times (except MAX3081/MAX3084/MAX3087)

MAX3080–MAX3089

Fail-Safe, High-Speed (10Mbps), Slew-Rate-Limited RS-485/RS-422 Transceivers



Figure 13. Receiver Propagation Delay Test Circuit



Figure 14. Driver Output Waveform and FFT Plot of MAX3086/MAX3087/MAX3088, and MAX3089 with SRL = GND, Transmitting a 20kHz Signal

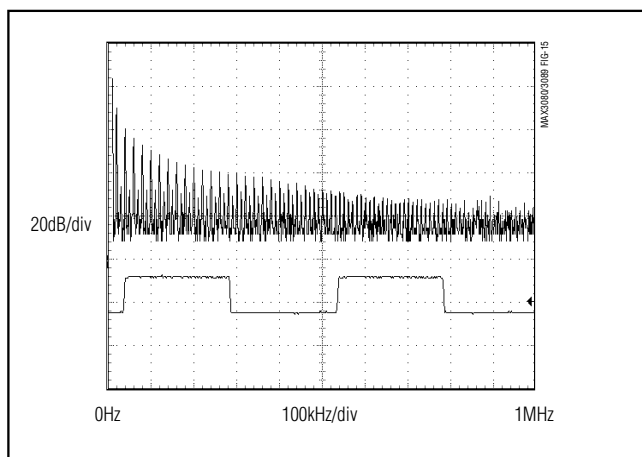

Figure 15. Driver Output Waveform and FFT Plot of MAX3083/MAX3084/MAX3085, and MAX3089 with SRL = VCC, Transmitting a 20kHz Signal

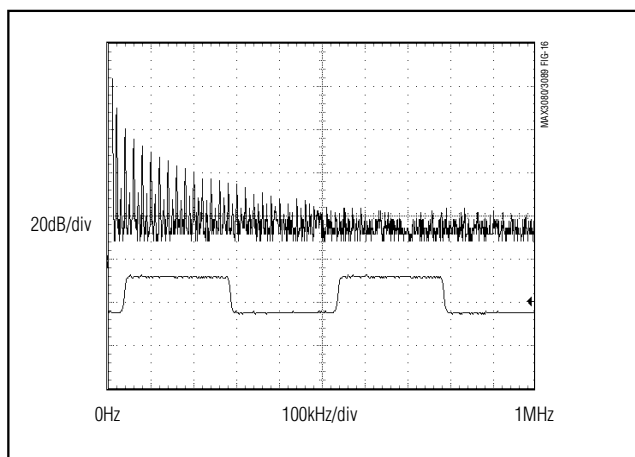

Figure 16. Driver Output Waveform and FFT Plot of MAX3080/MAX3081/MAX3082, and MAX3089 with SRL = Unconnected, Transmitting a 20kHz Signal

components with large amplitudes are evident. Figure 15 shows the same signal displayed for a MAX3083/MAX3084/MAX3085, and MAX3089 with SRL = VCC, transmitting under the same conditions. Figure 15's high-frequency harmonic components are much lower in amplitude, compared with Figure 14's, and the potential for EMI is significantly reduced. Figure 16 shows the same signal displayed for a MAX3080/MAX3081/MAX3082, and MAX3089 with SRL = unconnected, transmitting under the same conditions. Figure 16's high-frequency harmonic components are even lower.

In general, a transmitter's rise time relates directly to the length of an unterminated stub, which can be driven with only minor waveform reflections. The following equation expresses this relationship conservatively:

$$\text{Length} = t_{\text{RISE}} / (10 \times 1.5\text{ns/ft})$$

where t_{RISE} is the transmitter's rise time.

For example, the MAX3080's rise time is typically 1320ns, which results in excellent waveforms with a stub length up to 90 feet. A system can work well with longer unterminated stubs, even with severe reflections, if the waveform settles out before the UART samples them.

MAX3080–MAX3089

Fail-Safe, High-Speed (10Mbps), Slew-Rate-Limited RS-485/RS-422 Transceivers



Figure 17. Line Repeater for MAX3080/MAX3081/MAX3083/MAX3084/MAX3086/MAX3087, and MAX3089 in Full-Duplex Mode

Low-Power Shutdown Mode (Except MAX3082/MAX3085/MAX3088)

Low-power shutdown mode is initiated by bringing both \overline{RE} high and DE low. In shutdown, the devices typically draw only 1nA of supply current.

\overline{RE} and DE may be driven simultaneously; the parts are guaranteed not to enter shutdown if \overline{RE} is high and DE is low for less than 50ns. If the inputs are in this state for at least 600ns, the parts are guaranteed to enter shutdown.

Enable times t_{ZH} and t_{ZL} in the *Switching Characteristics* tables assume the part was not in a low-power shutdown state. Enable times $t_{ZH}(SHDN)$ and $t_{ZL}(SHDN)$ assume the parts were shut down. It takes drivers and receivers longer to become enabled from low-power shutdown mode ($t_{ZH}(SHDN)$, $t_{ZL}(SHDN)$) than from driver/receiver-disable mode (t_{ZH} , t_{ZL}).

Driver Output Protection

Two mechanisms prevent excessive output current and power dissipation caused by faults or by bus contention. The first, a foldback current limit on the output stage, provides immediate protection against short circuits over the whole common-mode voltage range (see *Typical Operating Characteristics*). The second, a thermal shutdown circuit, forces the driver outputs into a high-impedance state if the die temperature becomes excessive.



Figure 18. MAX3080/MAX3081/MAX3082, and MAX3089 with SRL = Unconnected, System Differential Voltage at 50kHz Driving 4000 feet of Cable

Line Length vs. Data Rate

The RS-485/RS-422 standard covers line lengths up to 4000 feet. For line lengths greater than 4000 feet, use the repeater application shown in Figure 17.

Figures 18, 19, and 20 show the system differential voltage for the parts driving 4000 feet of 26AWG twisted-pair wire at 110kHz into 120Ω loads.

Typical Applications

The MAX3082/MAX3085/MAX3088/MAX3089 transceivers are designed for bidirectional data communications on multipoint bus transmission lines. Figures 21 and 22 show typical network applications circuits. These parts can also be used as line repeaters, with cable lengths longer than 4000 feet, as shown in Figure 17.

To minimize reflections, the line should be terminated at both ends in its characteristic impedance, and stub lengths off the main line should be kept as short as possible. The slew-rate-limited MAX3082/MAX3085, and the two modes of the MAX3089, are more tolerant of imperfect termination.

MAX3080–MAX3089

Fail-Safe, High-Speed (10Mbps), Slew-Rate-Limited RS-485/RS-422 Transceivers



Figure 19. MAX3083/MAX3084/MAX3085, and MAX3089 with $SRL = V_{CC}$, System Differential Voltage at 50kHz Driving 4000 feet of Cable

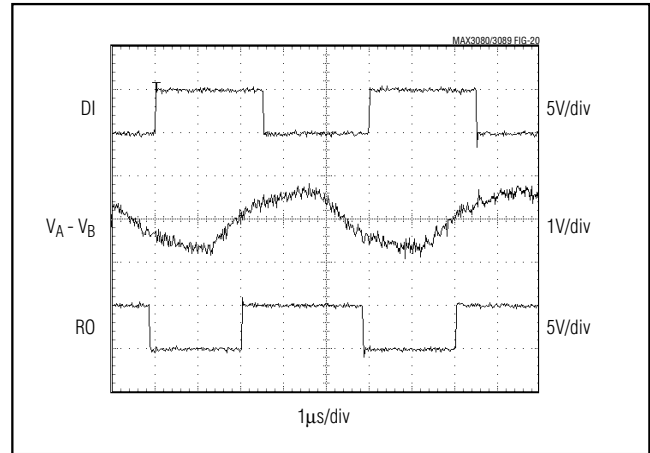

Figure 20. MAX3086/MAX3087/MAX3088, and MAX3089 with $SRL = GND$, System Differential Voltage at 200kHz Driving 4000 feet of Cable



Figure 21. Typical Half-Duplex RS-485 Network

MAX3080-MAX3089

Fail-Safe, High-Speed (10Mbps), Slew-Rate-Limited RS-485/RS-422 Transceivers



Figure 22. Typical Full-Duplex RS-485 Network

Ordering Information (continued)

PART	TEMP RANGE	PIN-PACKAGE
MAX3081 CSA	0°C to +70°C	8 SO
MAX3081CPA	0°C to +70°C	8 Plastic DIP
MAX3081ESA	-40°C to +85°C	8 SO
MAX3081EPA	-40°C to +85°C	8 Plastic DIP
MAX3082 CSA	0°C to +70°C	8 SO
MAX3082CPA	0°C to +70°C	8 Plastic DIP
MAX3082ESA	-40°C to +85°C	8 SO
MAX3082EPA	-40°C to +85°C	8 Plastic DIP
MAX3083 CSD	0°C to +70°C	14 SO
MAX3083CPD	0°C to +70°C	14 Plastic DIP
MAX3083ESD	-40°C to +85°C	14 SO
MAX3083EPD	-40°C to +85°C	14 Plastic DIP
MAX3084 CSA	0°C to +70°C	8 SO
MAX3084CPA	0°C to +70°C	8 Plastic DIP
MAX3084ESA	-40°C to +85°C	8 SO
MAX3084EPA	-40°C to +85°C	8 Plastic DIP
MAX3085 CSA	0°C to +70°C	8 SO
MAX3085CPA	0°C to +70°C	8 Plastic DIP
MAX3085ESA	-40°C to +85°C	8 SO
MAX3085EPA	-40°C to +85°C	8 Plastic DIP

PART	TEMP RANGE	PIN-PACKAGE
MAX3086 CSD	0°C to +70°C	14 SO
MAX3086CPD	0°C to +70°C	14 Plastic DIP
MAX3086ESD	-40°C to +85°C	14 SO
MAX3086EPD	-40°C to +85°C	14 Plastic DIP
MAX3087 CSA	0°C to +70°C	8 SO
MAX3087CPA	0°C to +70°C	8 Plastic DIP
MAX3087ESA	-40°C to +85°C	8 SO
MAX3087EPA	-40°C to +85°C	8 Plastic DIP
MAX3088 CSA	0°C to +70°C	8 SO
MAX3088CPA	0°C to +70°C	8 Plastic DIP
MAX3088ESA	-40°C to +85°C	8 SO
MAX3088EPA	-40°C to +85°C	8 Plastic DIP
MAX3089 CSD	0°C to +70°C	14 SO
MAX3089CPD	0°C to +70°C	14 Plastic DIP
MAX3089ESD	-40°C to +85°C	14 SO
MAX3089EPD	-40°C to +85°C	14 Plastic DIP

Package Information

For the latest package outline information, go to www.maxim-ic.com/packages.

MAX3080–MAX3089

Fail-Safe, High-Speed (10Mbps), Slew-Rate-Limited RS-485/RS-422 Transceivers



Maxim cannot assume responsibility for use of any circuitry other than circuitry entirely embodied in a Maxim product. No circuit patent licenses are implied. Maxim reserves the right to change the circuitry and specifications without notice at any time. The parametric values (min and max limits) shown in the Electrical Characteristics table are guaranteed. Other parametric values quoted in this data sheet are provided for guidance.

Maxim Integrated 160 Rio Robles, San Jose, CA 95134 USA 1-408-601-1000

21

Mouser Electronics

Authorized Distributor

Click to View Pricing, Inventory, Delivery & Lifecycle Information:

[Analog Devices Inc.:](#)

[MAX3087CSA+](#) [MAX3087ESA+](#) [MAX3087CPA+](#) [MAX3087CSA+T](#) [MAX3087EPA+](#) [MAX3087ESA+T](#)