

### Product Overview

The RFMD's RFSA3413 is a 4-bit digital step attenuator (DSA) that features high linearity over the entire 15dB gain control range with 1.0dB steps. The RFSA3413 uses parallel control interface. The RFSA3413 has a low insertion loss of 1.4dB at 2GHz. Patent pending circuit architecture provides overshoot-free transient switching performance. The RFSA3413 is available in a 3mm x 3mm QFN package.



16 Pad 3.0 x 3.0 x 0.85 mm QFN Package

### Key Features

- 4-Bit, 15 dB Range, 1.0 dB Step
- Patented Circuit Architecture
- Overshoot-free Transient Switching Performance
- Frequency Range 5 MHz to 6000 MHz
- High Linearity, IIP3 > +55 dBm
- Parallel Control Interface
- Fast Switching, 120 ns Typical
- Single Supply 3 V to 5 V Operation
- 3V CMOS Logic Compatible
- RF Oins have No DC Voltage present, Can be DC Grounded Externally

### Functional Block Diagram

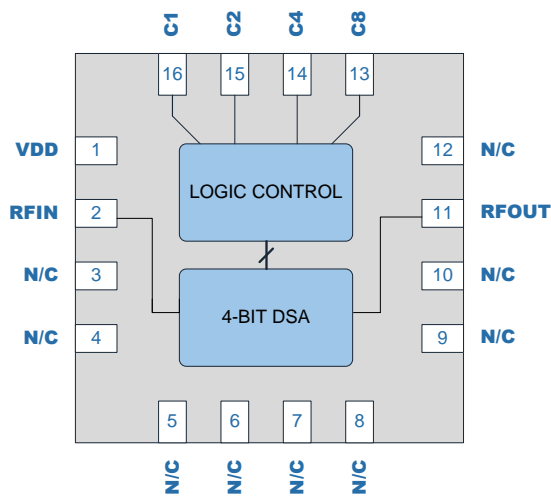

Top View

### Applications

- 2G through 4G Base Stations
- Point-to-Point
- WiMax / Wi-Fi
- Test Equipment

### Ordering Information

Part No.	Description
RFSA3413TR7	7" Reel with 2500 pieces
RFSA3413PCK-410	5 MHz to 6000 MHz PCBA with 5-piece sample bag

## Absolute Maximum Ratings

Parameter	Rating
Storage Temperature	-40 to +150 °C
RF Input Power at RFIN, T <sub>C</sub> =85°C	+30 dBm
RF Input Power at RFOUT, T <sub>C</sub> =85°C	+27 dBm
Device Supply Voltage (V <sub>DD</sub> )	-0.5 to +6 V
All Other DC and Logic Pins, V <sub>DD</sub> Applied Prior to Any Other Pin Voltages	-0.5 to +6 V

Exceeding any one or a combination of the Absolute Maximum Rating conditions may cause permanent damage to the device. Extended application of Absolute Maximum Rating conditions to the device may reduce device reliability.

## Recommended Operating Conditions

Parameter	Min	Typ	Max	Units
Device Supply Voltage (V <sub>DD</sub> ) <sup>(1)</sup>	+2.7		+5.5	V
Digital Logic High	+1.6		V <sub>DD</sub>	V
Digital Logic Low	-0.2		+0.9	
Operating Temperature <sup>(2)</sup>	-40		+105	°C
Operating Junction Temperature			+125	°C

(1) Device performance is constant over this range; LDO on chip

(2) Derate RF Input Handling about 85°C

## Electrical Specifications

Parameter	Conditions <sup>(1)</sup>	Min	Typ	Max	Units
Operational Frequency Range		5		6000	MHz
Insertion Loss	2000MHz, 0 dB attenuation		1.4	2.8	dB
Attenuation Range	1.0 dB step size		15		dB
Absolute Attenuation Error			0.2 ±4%		dB
Input IP3			+55		dBm
Input P0.1dB			+30		dBm
Input/Output Return Loss			15		dB
Input and Output Impedance			50		Ω
Attenuation Step Time	50% control signal level to 10% / 90% RF		120		nsec
Successive Step Phase Delta	2000MHz		2		Deg
Supply Current, I <sub>DD</sub>	Steady state, transient between states higher		180	300	μA
RF Input Power at RFIN	Continuous operation at +85°C case temperature			+27	dBm
RF Input Power at RFOUT	Continuous operation at +85°C case temperature			+20	dBm
Thermal Resistance, θ <sub>Jc</sub>	At maximum attenuation state with RF power		55		°C/W

Notes:

1. Test conditions unless otherwise noted: V<sub>DD</sub> = +5.0 V, Temp = +25 °C, 2000MHz, 50 Ω system.

RF Typical Performance Plots

T = 25°C, V<sub>DD</sub> = 5V unless otherwise noted

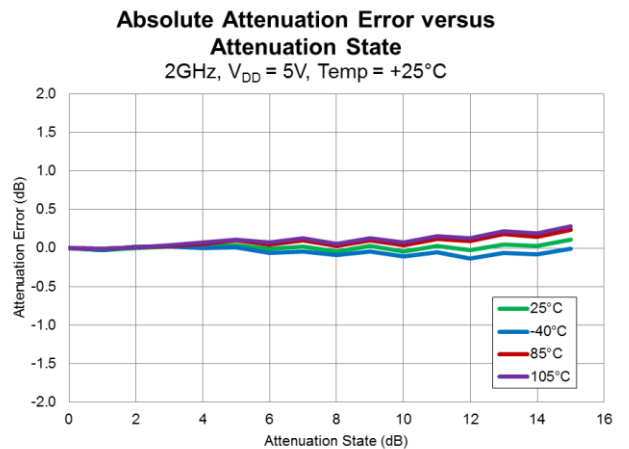
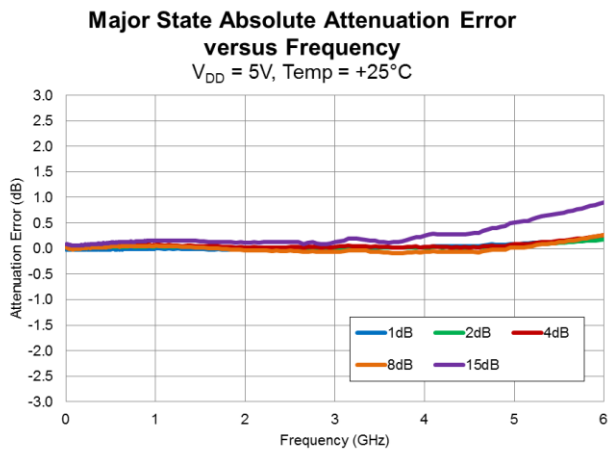
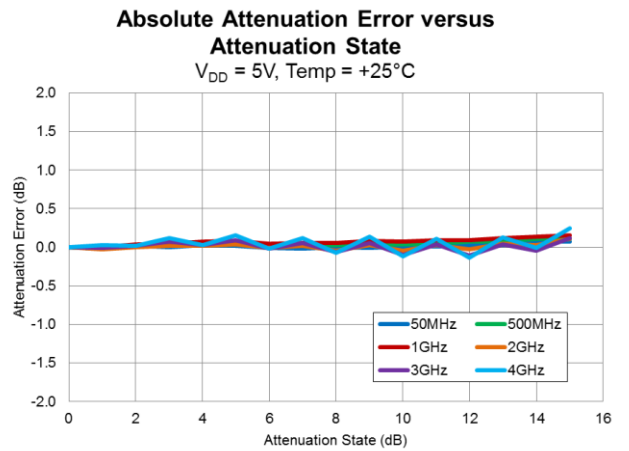
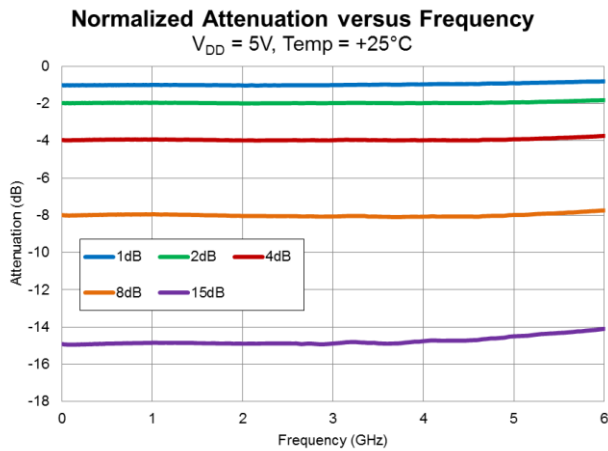
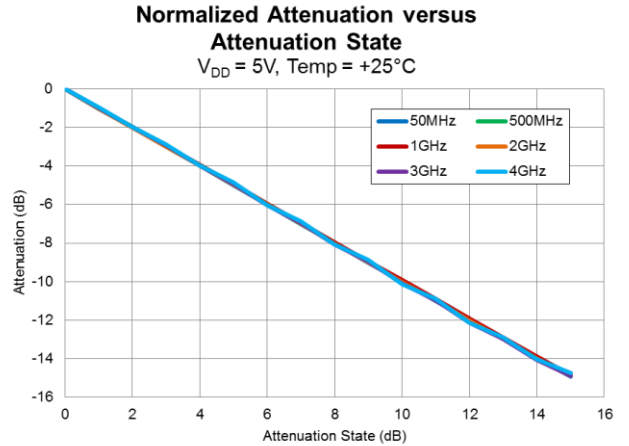
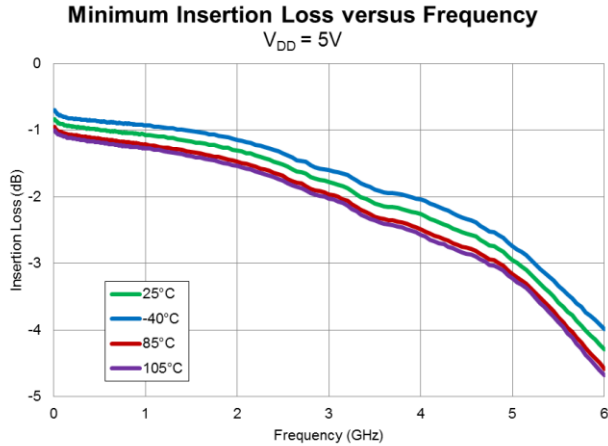

RF Typical Performance Plots (continue)

T = 25°C, V<sub>DD</sub> = 5V unless otherwise noted

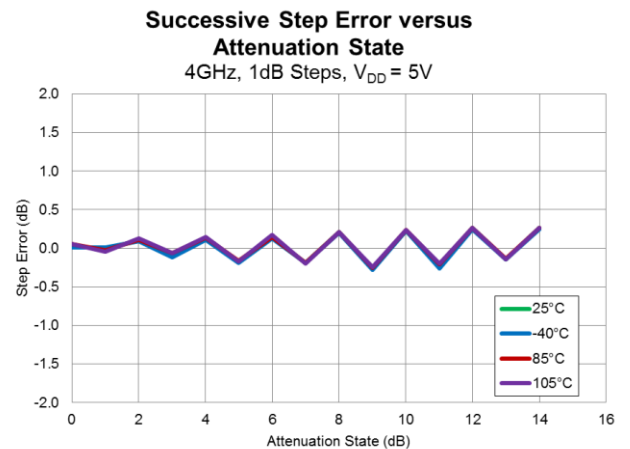
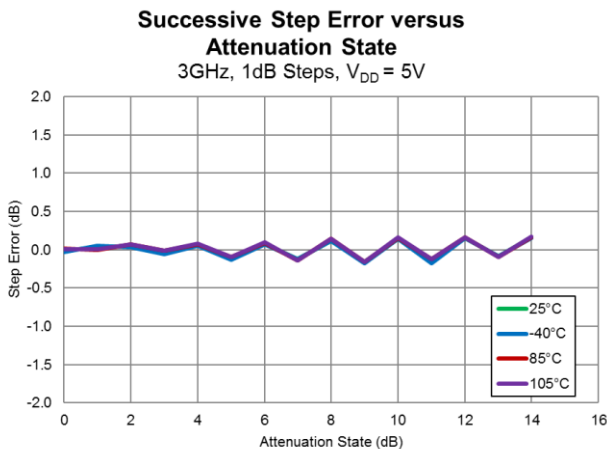
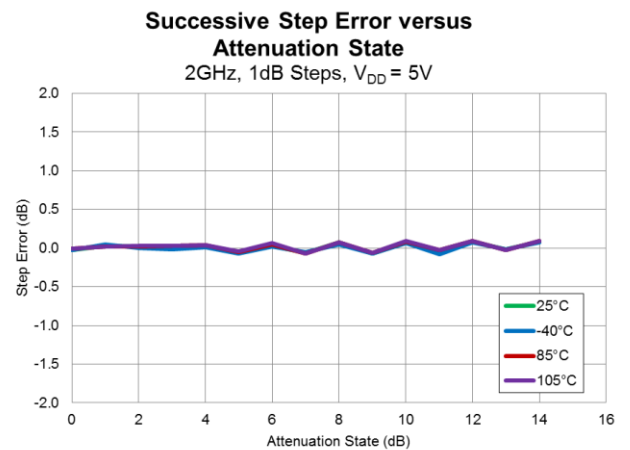
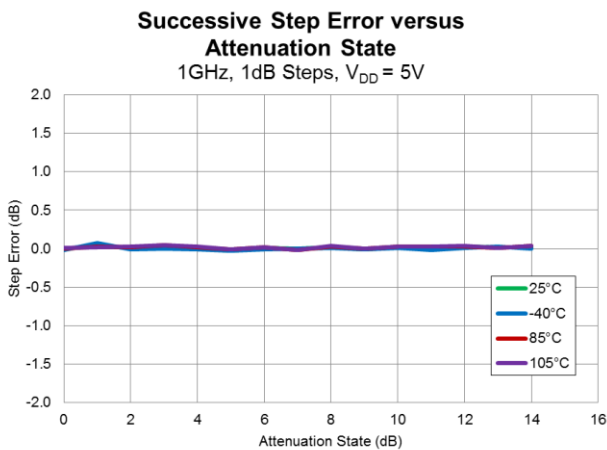
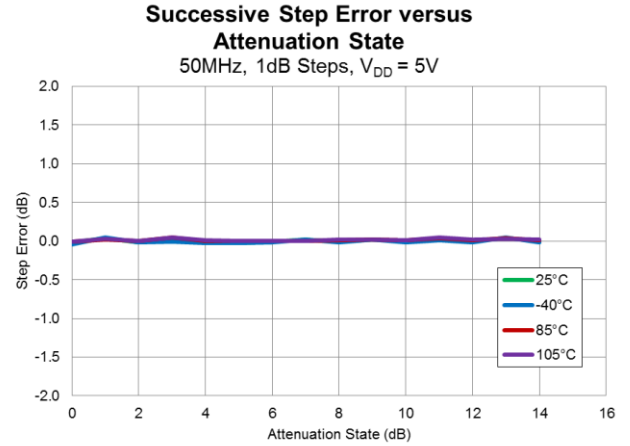
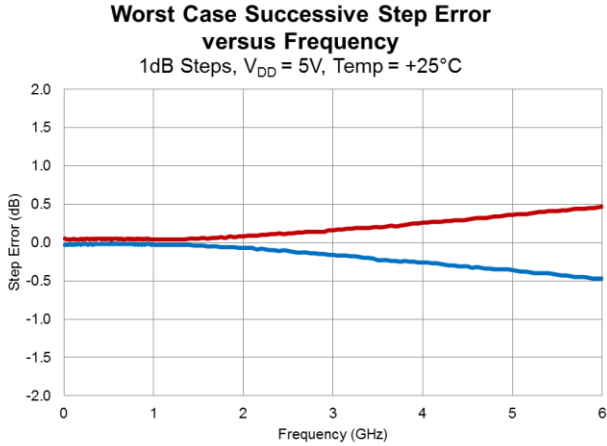

RF Typical Performance Plots (continue)

T = 25°C, V<sub>DD</sub> = 5V unless otherwise noted

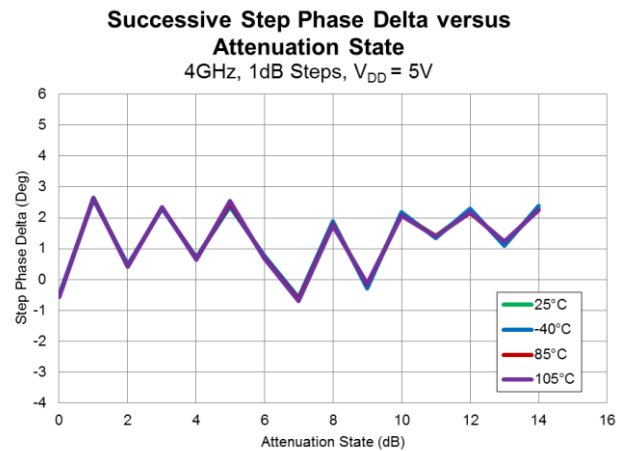
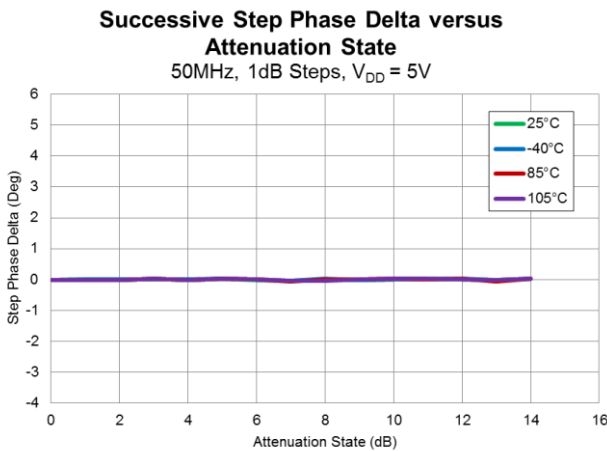
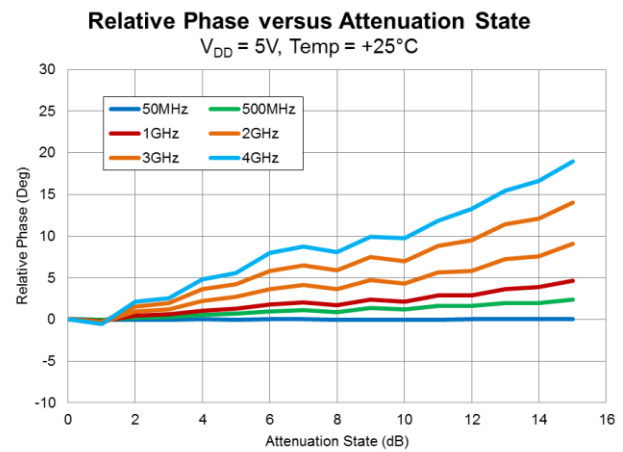
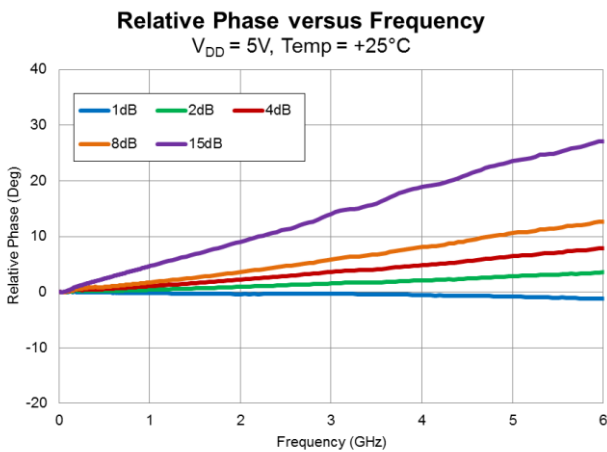
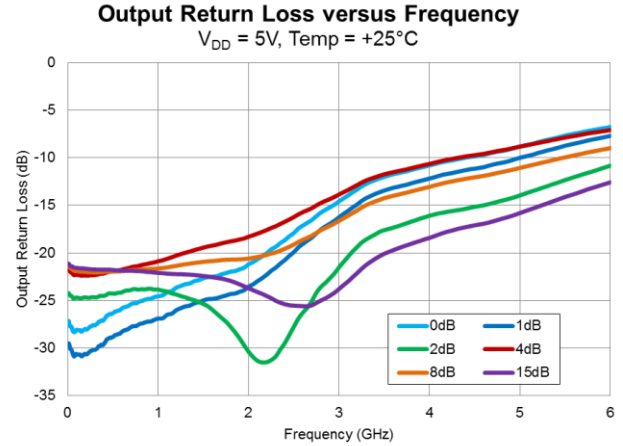
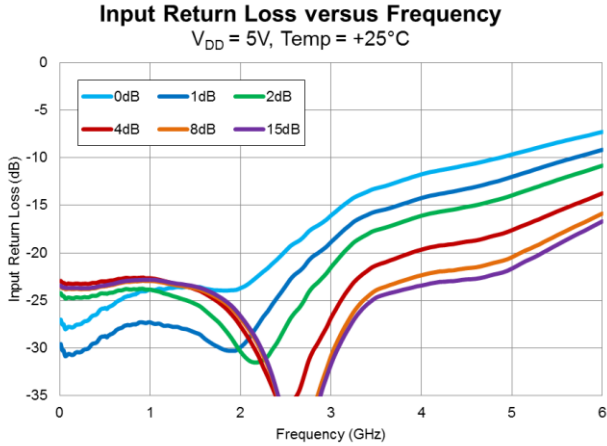

RF Typical Performance Plots (continue)

T = 25°C, V<sub>DD</sub> = 5V unless otherwise noted

**Input IP3 versus Frequency**

V<sub>DD</sub> = 5V, RF 50MHz to 4000MHz Pin = +18dBm/Tone,  
RF 5MHz Pin = +15dBm/Tone, Temp = +25°C

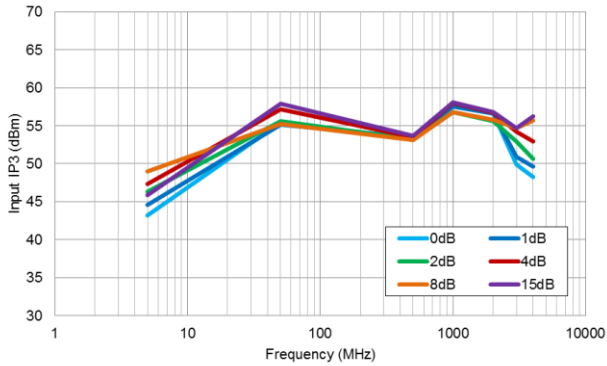

**Input IP3 versus Attenuation State**

V<sub>DD</sub> = 5V, RF 50MHz to 4000MHz Pin = +18dBm/Tone,  
RF 5MHz Pin = +15dBm/Tone, Temp = +25°C

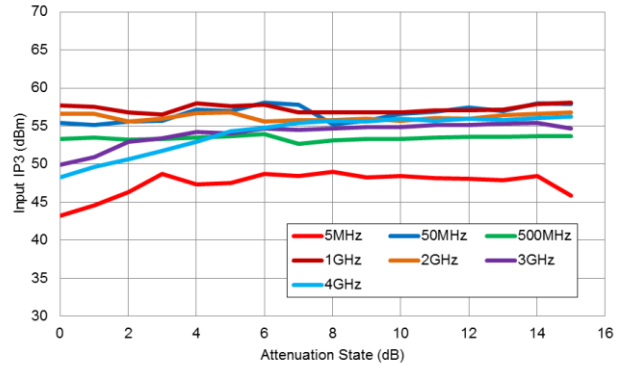

**Input IP3 versus Attenuation State**

RF 2GHz, V<sub>DD</sub>=5V, Pin=+18dBm/Tone

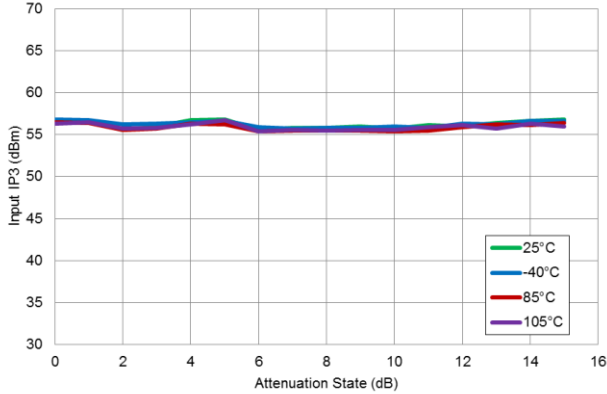

**Supply Current versus Attenuation State**

RF 2GHz, V<sub>DD</sub> = 5V

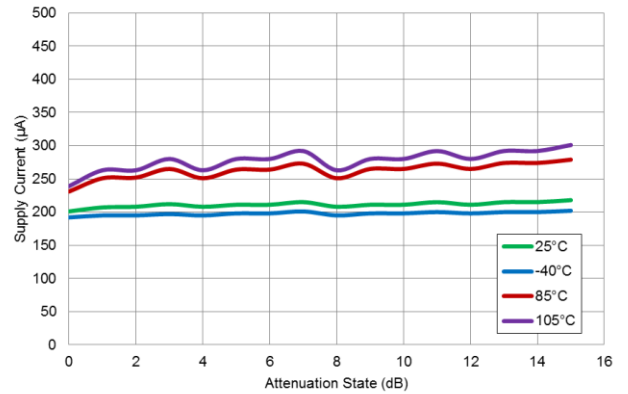

**Evaluation Board Schematic, RFSA2534PCK-410 5MHz to 6000MHz**

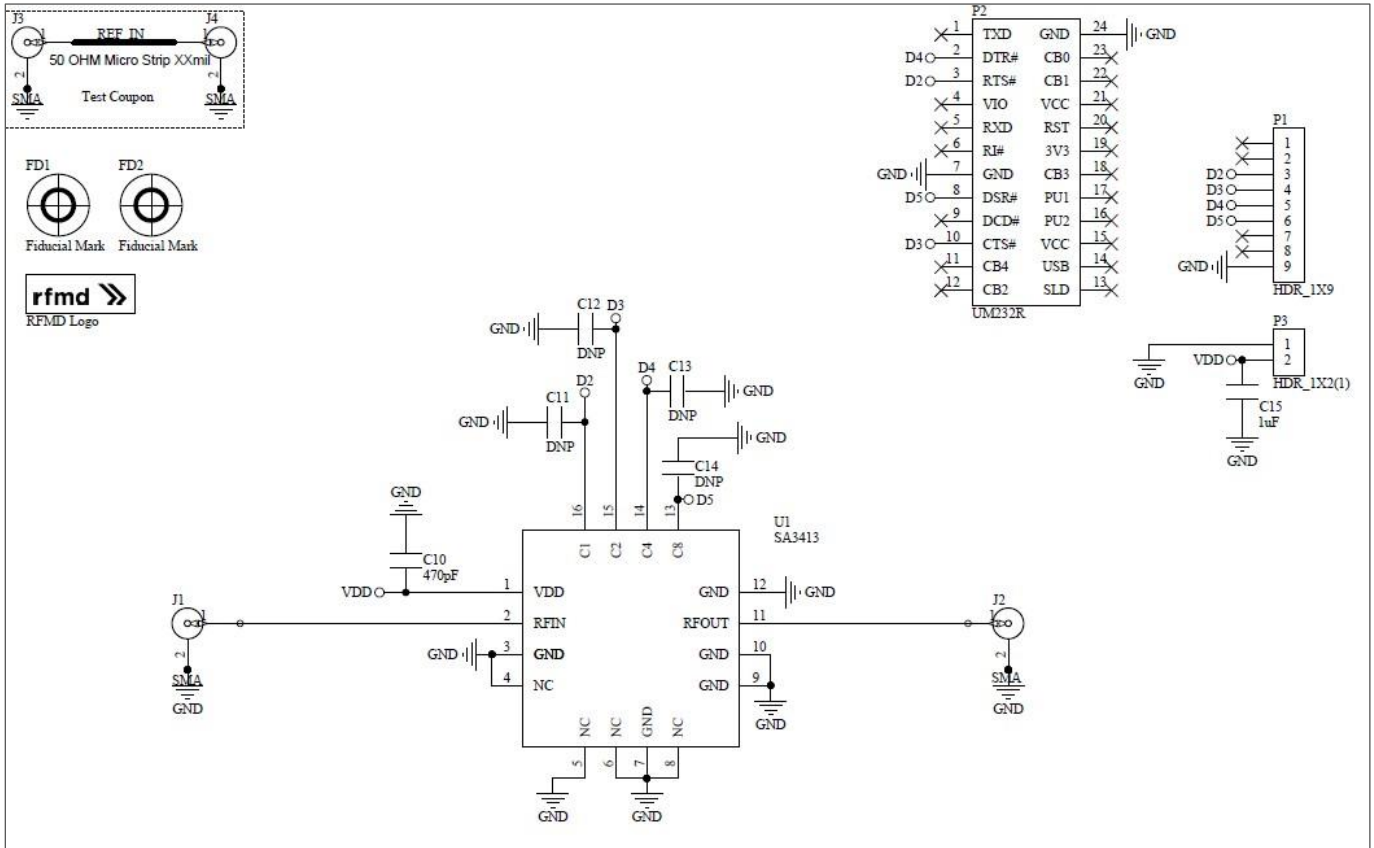

**Bill of Material – RFSA3413PCK-410**

Reference Des.	Value	Description	Manuf.	Part Number
n/a	n/a	Printed Circuit Board	Qorvo	SA3413-410(A)
U1	n/a	Module, Digital Step Attenuator, 5-6000MHz	Qorvo	RFSA3413
C10	470 pF	CAP, 470pF, 5%, 50V, C0G, 0402	Murata Electronics	GRM1555C1H471JA01D
C15	1 μF	CAP, 1 μF, 10%, 25V, X7R, 1206	Taiyo Yuden (USA), Inc.	CE TMK316BJ105KL-T
J1, J2, J3, J4	n/a	CONN, SMA, END LNCH, UNIV, HYB MNT, FLT	Molex	SD-73251-4000
P1	n/a	CONN, HDR, ST, 9-PIN, 0.100"	SAMTEC	TSW-109-07-G-S
P2	n/a	CONN, SKT, 24-PIN DIP, 0.600", T/H	Aries Electronics Inc.	24-6518-10
P3	n/a	CONN, HDR, ST, PLRZD, 2-PIN, 0.100"	ITW Pancon	MPSS100-2-C
M1	n/a	Module, USB to Serial Uart, SSOP-28	Future Technology Devices	UM232R

**Notes:**

1. M1 should be mounted into P2 with respect to the Pin 1 alignment of M1 and P2.

**Evaluation Board Assembly, RFSA3413PCK-410 5MHz to 6000MHz**

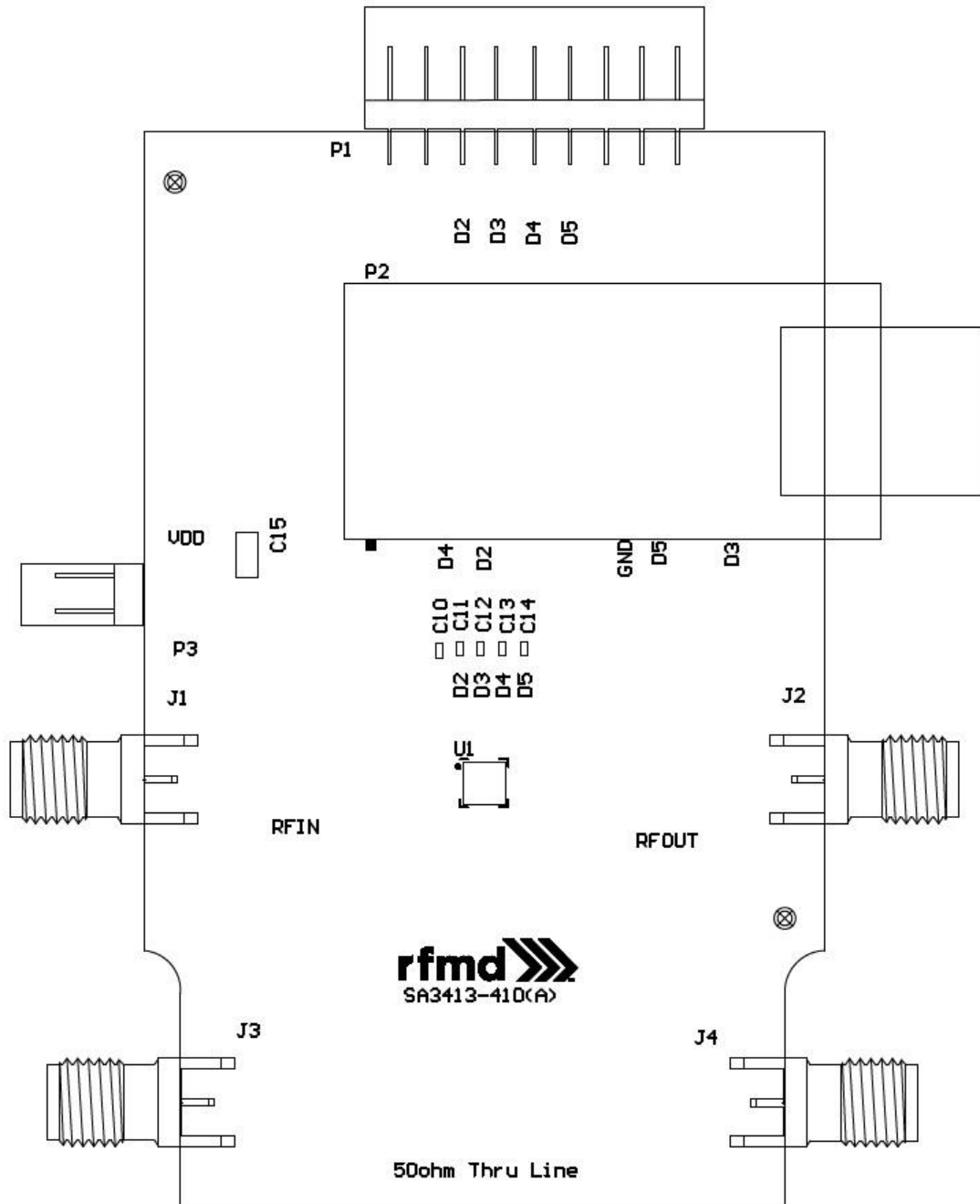



## RFSA3413 Programming by Using USB Interface

---

Refer to Qorvo Control Bit Generator (CBG) Software Reference Manual for detailed instructions on how to setup the software for use. Apply the supply voltage to P3. Select RFSA3413 from the Qorvo Parts List of the CBG user interface. Set the attenuation value using the CBG Graphic User Interface (GUI). The attenuator is set to the desired state and measurements can be taken.

## RFSA3413 Programming by Using Its Parallel Bus

---

This configuration allows the user to control the attenuator through the P1 connector using an external harness. Remove the USB interface board if it is currently installed on the evaluation board. Connect a user-supplied harness to the P1 connector. The parallel bus signal names for P1 are indicated on the evaluation board. Cross reference for device pin names to P1 connector signals is as follows: C1 = D2, C2 = D3, C4 = D4, C8 = D5. Apply the supply voltage to P3. Send the appropriate signals onto the parallel bus lines in accordance with the Parallel Interface Attenuation Truth Table. The attenuator is set to the desired state and measurements can be taken.

## Power-up State

---

The default state is minimum attenuation (0dB) when supply voltage is applied to the attenuator. If a different attenuation state is desired during power up, this can be accomplished by applying signals according to the Parallel Interface Attenuation Truth Table. The attenuator will power up to the state applied to the parallel bus during turn on.

## Control Bit Truth Table (Major States)

---

D5 (C8)	D4 (C4)	D3 (C2)	D2 (C1)	Attenuation State
H	H	H	H	0 dB *
H	H	H	L	1 dB
H	H	L	H	2 dB
H	L	H	H	4 dB
L	H	H	H	8 dB
L	L	L	L	15 dB

\*0 dB Reference State with the Insertion Loss as specified

## Pad Configuration and Description

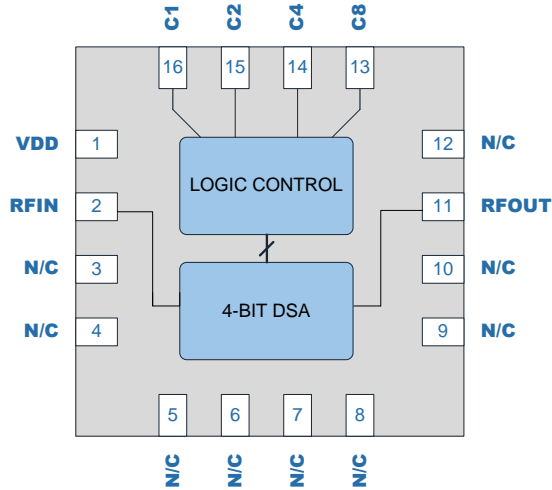

Top View

Pad No.	Label	Description
1	VDD	DC Supply Voltage Input
2	RFIN	RF Input, Incident RF power must enter this pin for rated thermal performance and reliability. Do not apply DC to this pin. Can be DC grounded externally. Internally, a resistors in between this Pin and ground.
3, 4, 5, 6, 7, 8, 9, 10, 12	NC	No Internal Connection. Land pads should be provided on PCB for mounting integrity.
11	RFOUT	RF Output, Can be DC grounded externally. Internally, a resistors in between this Pin and ground.
13	C8	8 dB Bit, Parallel Control Input; 3V CMOS compatible logic.
14	C4	4 dB Bit, Parallel Control Input; 3V CMOS compatible logic.
15	C2	2 dB Bit, Parallel Control Input; 3V CMOS compatible logic.
16	C1	1 dB Bit, Parallel Control Input; 3V CMOS compatible logic.
Backside Paddle	GND	RF/DC ground. Quantity 9 Ground via holes recommended.

**Package Outline**

(Dimensions in Millimeters)

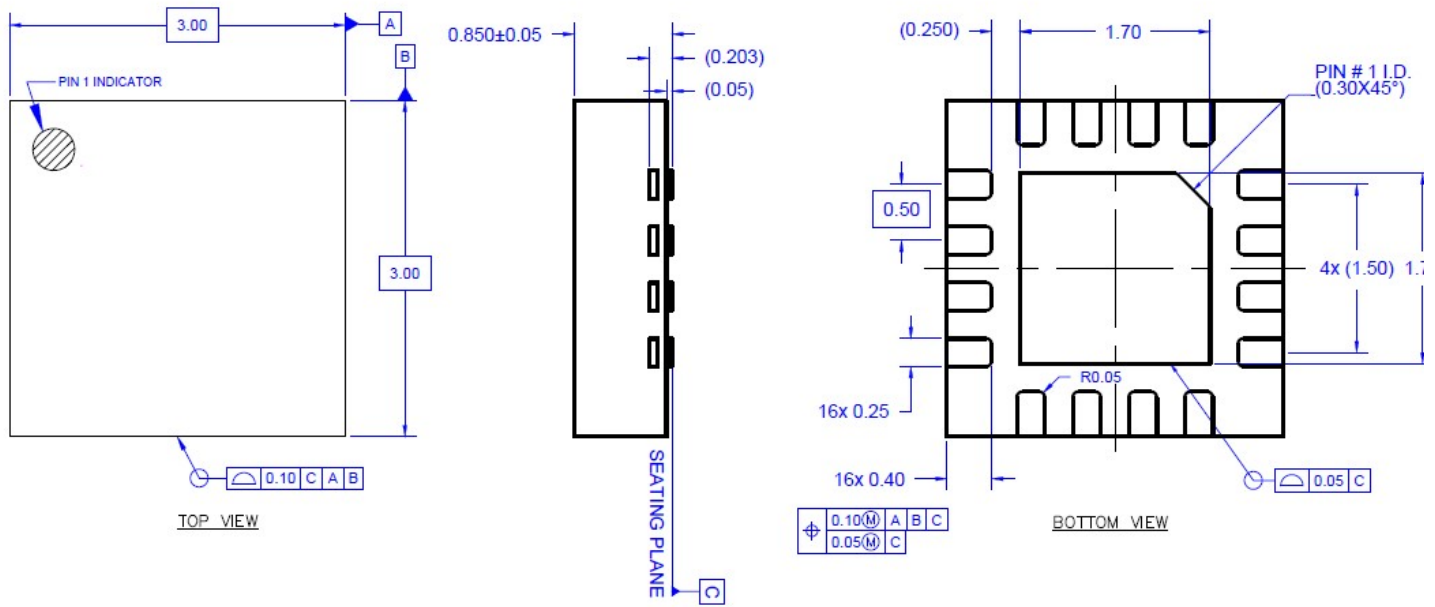

**Package Marking**

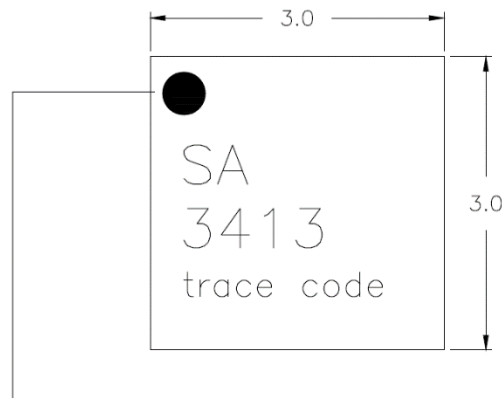

Pin 1 Indicator  
Trace code to be assigned by Subcon

Tape and Reel Information – Carrier and Cover Tape Dimensions

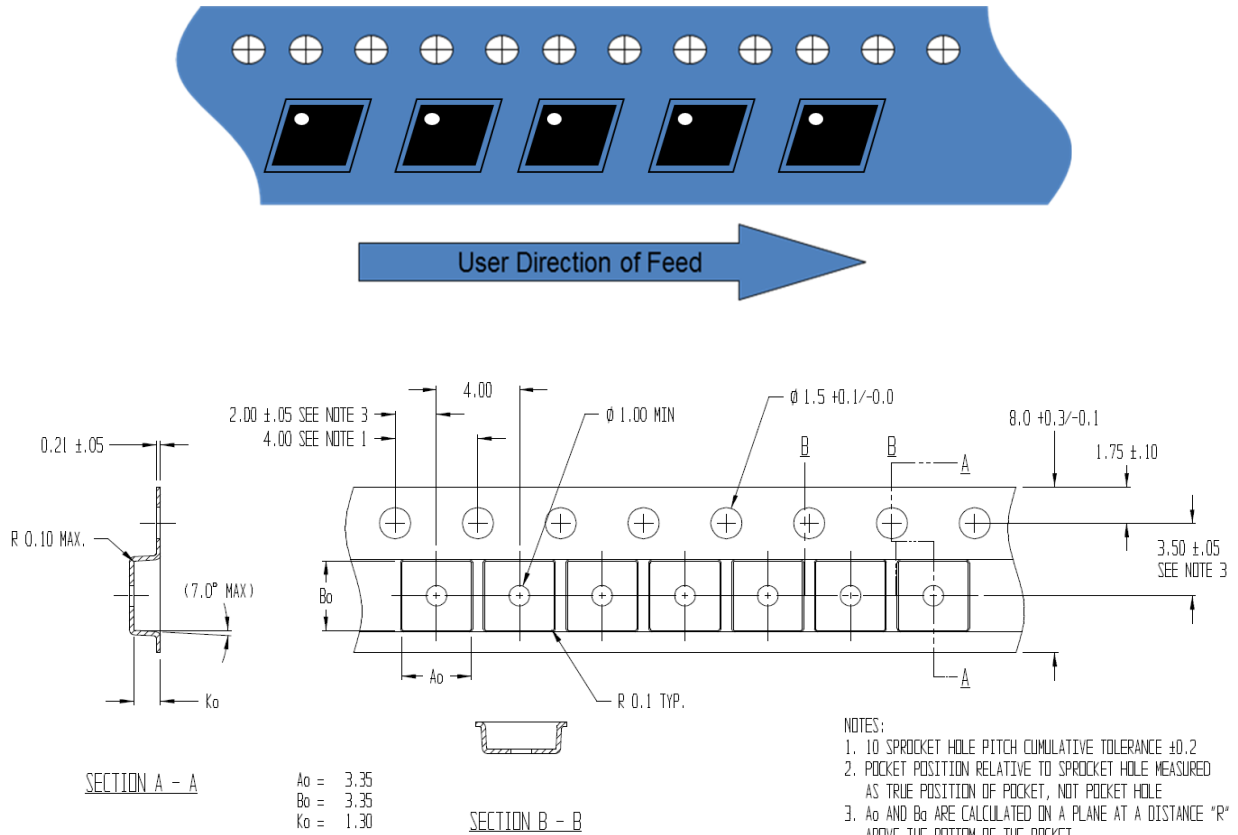

Feature	Measure	Symbol	Size (in)	Size (mm)
Cavity	Length	A0	0.132	3.35
	Width	B0	0.132	3.35
	Depth	K0	0.051	1.30
	Pitch	P1	0.315	4.00
Centerline Distance	Cavity to Perforation - Length Direction	P2	0.079	2.00
	Cavity to Perforation - Width Direction	F	0.138	3.50
Cover Tape	Width	C	0.362	5.40
Carrier Tape	Width	W	0.315	8.00

Tape and Reel Information – Reel Dimensions

Standard T/R size = 2500 pieces on a 7" reel.

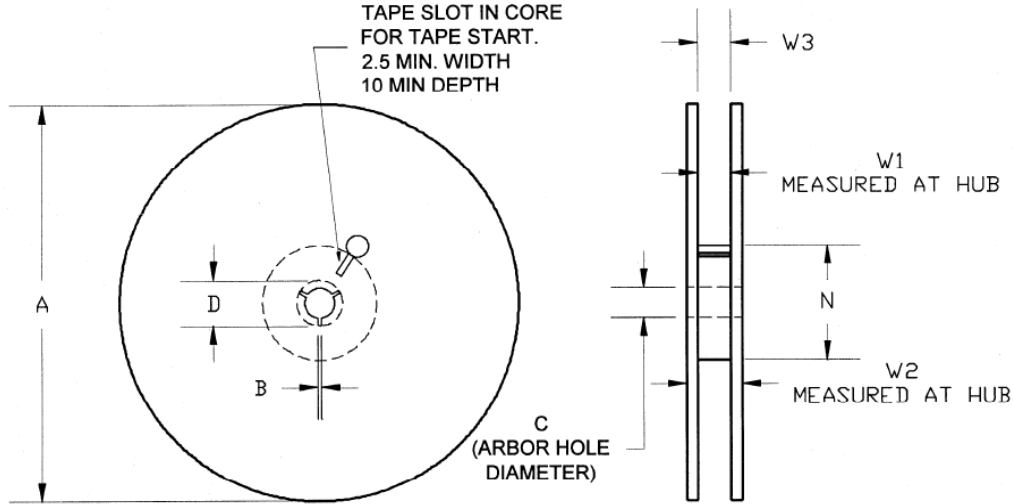

Feature	Measure	Symbol	Size (in)	Size (mm)
Flange	Diameter	A	6.969	177.0
	Thickness	W2	0.559	14.2
	Space Between Flange	W1	0.346	8.8
Hub	Outer Diameter	N	2.283	58.0
	Arbor Hole Diameter	C	0.512	13.0
	Key Slit Width	B	0.079	2.0
	Key Slit Diameter	D	0.787	20.0

Tape and Reel Information – Tape Length and Label Placement

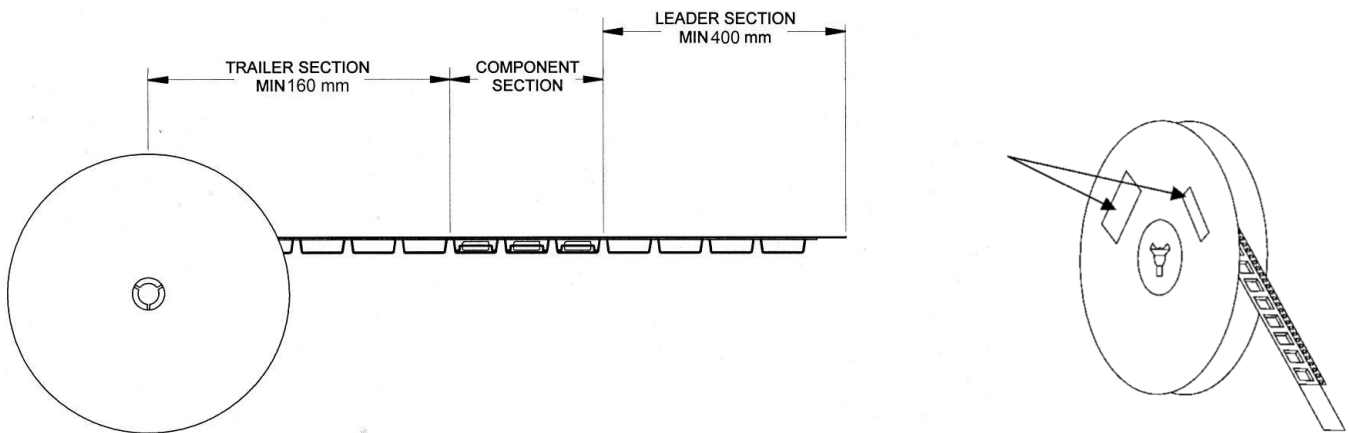

Notes:

1. Empty part cavities at the trailing and leading ends are sealed with cover tape. See EIA 481-1-A.
2. Labels are placed on the flange opposite the sprockets in the carrier tape.

## Handling Precautions

Parameter	Rating	Standard
ESD – Human Body Model (HBM)	Class 1C	ESDA / JEDEC JS-001-2012
ESD – Charged Device Model (CDM)	Class C3	JEDEC JESD22-C101F
MSL – Moisture Sensitivity Level	Level 1	IPC/JEDEC J-STD-020



Caution!  
ESD-Sensitive Device

## Solderability

Compatible with both lead-free (260°C max. reflow temp.) and tin/lead (245°C max. reflow temp.) soldering processes. Solder profiles available upon request.

Contact plating: Matte Sn (*Plating thickness Sn 8 to 20 μm*)

## RoHS Compliance

This part is compliant with 2011/65/EU RoHS directive (Restrictions on the Use of Certain Hazardous Substances in Electrical and Electronic Equipment) as amended by Directive 2015/863/EU.

This product also has the following attributes:

- Halogen Free (Chlorine, Bromine)
- Antimony Free
- TBBP-A (C<sub>15</sub>H<sub>12</sub>Br<sub>4</sub>O<sub>2</sub>) Free
- PFOS Free
- SVHC Free

## Contact Information

For the latest specifications, additional product information, worldwide sales and distribution locations:

**Web:** [www.qorvo.com](http://www.qorvo.com)

**Tel:** 1-844-890-8163

**Email:** [customer.support@qorvo.com](mailto:customer.support@qorvo.com)

For technical questions and application information:

**Email:** [appsupport@qorvo.com](mailto:appsupport@qorvo.com)

## Important Notice

The information contained herein is believed to be reliable; however, Qorvo makes no warranties regarding the information contained herein and assumes no responsibility or liability whatsoever for the use of the information contained herein. All information contained herein is subject to change without notice. Customers should obtain and verify the latest relevant information before placing orders for Qorvo products. The information contained herein or any use of such information does not grant, explicitly or implicitly, to any party any patent rights, licenses, or any other intellectual property rights, whether with regard to such information itself or anything described by such information. **THIS INFORMATION DOES NOT CONSTITUTE A WARRANTY WITH RESPECT TO THE PRODUCTS DESCRIBED HEREIN, AND QORVO HEREBY DISCLAIMS ANY AND ALL WARRANTIES WITH RESPECT TO SUCH PRODUCTS WHETHER EXPRESS OR IMPLIED BY LAW, COURSE OF DEALING, COURSE OF PERFORMANCE, USAGE OF TRADE OR OTHERWISE, INCLUDING THE IMPLIED WARRANTIES OF MERCHANTABILITY AND FITNESS FOR A PARTICULAR PURPOSE.**

Without limiting the generality of the foregoing, Qorvo products are not warranted or authorized for use as critical components in medical, life-saving, or life-sustaining applications, or other applications where a failure would reasonably be expected to cause severe personal injury or death.

Copyright 2019 © Qorvo, Inc. | Qorvo is a registered trademark of Qorvo, Inc.

# Mouser Electronics

Authorized Distributor

Click to View Pricing, Inventory, Delivery & Lifecycle Information:

Qorvo:

[RFSA3413TR7](#) [RFSA3413PCK-410](#)