

Series: Jaguar

Description: 3G/4G LTE 2xMiMo Vehicular Antenna

PART NUMBER: W1919

Features:

- 698-960/1710-3800MHz
- Extremely compact size LTE MiMo Antenna
 - 78.2 x 78.2 x 30.3mm
- Standard cable length 3m with SMA Male connectors
- IP67
- Mounting with adhesive tape

Applications:

- Indoor and outdoor use
- 2G/3G/4G radios
- 2xLTE MiMo
- 3G Main + Diversity
- Vehicular, Telematics, Transportation
- Cellular access points



All dimensions are in mm / inches

Issue: 1748P

In the effort to improve our products, we reserve the right to make changes judged to be necessary.

CONFIDENTIAL AND PROPRIETARY INFORMATION

This document contains confidential and proprietary information of Pulse Electronics, Inc. (Pulse) and is protected by copyright, trade secret and other state and federal laws. Its receipt or possession does not convey any rights to reproduce, disclose its contents, or to manufacture, use or sell anything it may describe. Reproduction, disclosure or use without specific written authorization of Pulse is strictly forbidden.

For more information:

Pulse Worldwide Headquarters
15255 Innovation Drive #100
San Diego, CA 92128
USA
Tel: 1-858-674-8100

Pulse/Larsen Antennas
18110 SE 34th St Bldg 2 Suite 250
Vancouver, WA 98683
USA
Tel: 1-360-944-7551

Europe Headquarters
Pulse GmbH & Do, KG
Zeppelinstrasse 15
Herrenberg, Germany
Tel: 49 7032 7806 0

Pulse (Suzhou) Wireless Products Co, Inc.
99 Huo Ju Road(#29 Bldg,4th Phase
Suzhou New District
Jiangsu Province, Suzhou 215009 PR China
Tel: 86 512 6807 9998

Preliminary



Description: 3G/4G LTE 2xMiMo Vehicular Antenna

Series: Jaguar

PART NUMBER: W1919

ELECTRICAL SPECIFICATIONS

| | |
|--------------------|--|
| Frequency | 698-960 MHz / 1710-2690MHz/3400-3800MHz |
| Nominal Impedance | 50 Ω |
| Return Loss | -10 dB |
| Isolation | -15 dB |
| Radiation Pattern | Omni |
| Gain | -0.42dBi @698-960MHz 1.77dBi @1710-2690MHz 1.76dBi @3400-3800MHz |
| Polarization | Vertical |
| Power Withstanding | 5W |

MECHANICAL SPECIFICATIONS

| | |
|--------------------------|--------------|
| Overall Length | 78.2mm |
| Weight | 142g |
| Antenna Color / Material | Black, PC |
| Connector type | SMA Male |
| Cable type | RG174, Black |
| Cable length | 3000mm |

ENVIRONMENTAL SPECIFICATIONS

| | |
|-----------------------|--------------|
| Operating Temperature | -40 ~ +85° C |
| Storage Temperature | -40 ~ +85° C |
| Ingress Protection | IP67 |
| RoHS Compliant | Yes |

Issue: 1748P

In the effort to improve our products, we reserve the right to make changes judged to be necessary.

CONFIDENTIAL AND PROPRIETARY INFORMATION

This document contains confidential and proprietary information of Pulse Electronics, Inc. (Pulse) and is protected by copyright, trade secret and other state and federal laws. Its receipt or possession does not convey any rights to reproduce, disclose its contents, or to manufacture, use or sell anything it may describe. Reproduction, disclosure or use without specific written authorization of Pulse is strictly forbidden.

Preliminary



Description: 3G/4G LTE 2xMiMo Vehicular Antenna

Series: Jaguar

PART NUMBER: W1919

MECHANICAL DRAWING

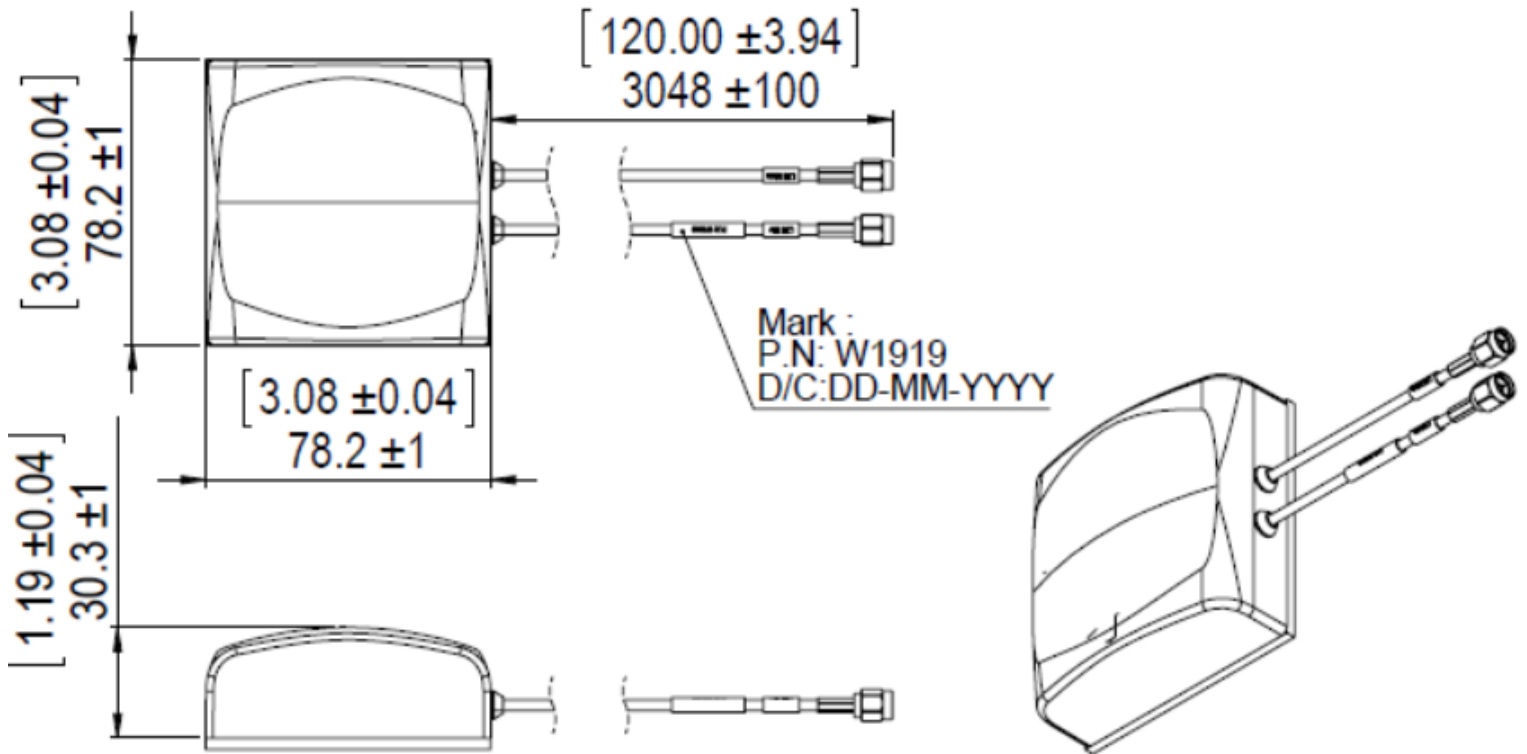

| Part NO. | CABLE LENGTH | LTE Main Cable | LTE Div Cable | APPEARANCE COLOR | MOUNTING |
|----------|--------------|----------------|----------------|------------------|----------------|
| W1919 | 3M(118.11") | RG174+SMA Male | RG174+SMA Male | Black | Adhesive Mount |

Issue: 1748P

In the effort to improve our products, we reserve the right to make changes judged to be necessary.

CONFIDENTIAL AND PROPRIETARY INFORMATION

This document contains confidential and proprietary information of Pulse Electronics, Inc. (Pulse) and is protected by copyright, trade secret and other state and federal laws. Its receipt or possession does not convey any rights to reproduce, disclose its contents, or to manufacture, use or sell anything it may describe. Reproduction, disclosure or use without specific written authorization of Pulse is strictly forbidden.

Preliminary



Description: 3G/4G LTE 2xMiMo Vehicular Antenna

Series: Jaguar

PART NUMBER: W1919

CHARTS

Return Loss

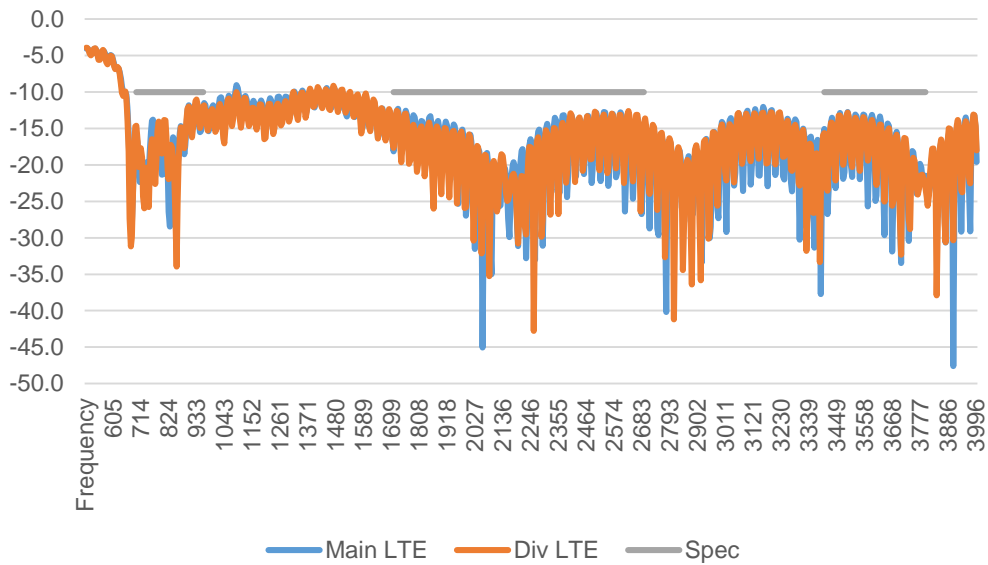

Isolation

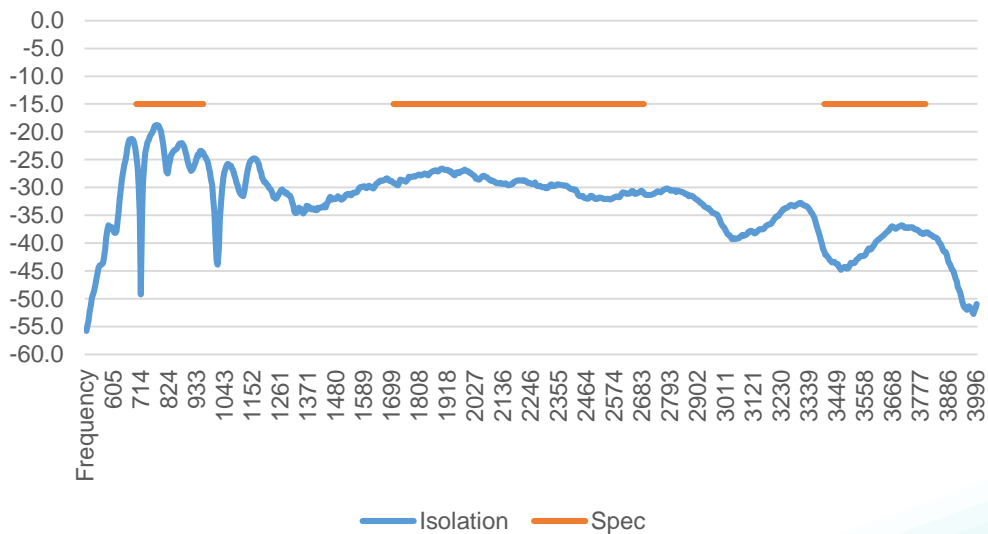

Note : Antenna measured with 10ft cable

Issue: 1748P

In the effort to improve our products, we reserve the right to make changes judged to be necessary.

CONFIDENTIAL AND PROPRIETARY INFORMATION

This document contains confidential and proprietary information of Pulse Electronics, Inc. (Pulse) and is protected by copyright, trade secret and other state and federal laws. Its receipt or possession does not convey any rights to reproduce, disclose its contents, or to manufacture, use or sell anything it may describe. Reproduction, disclosure or use without specific written authorization of Pulse is strictly forbidden.

Preliminary



Description: 3G/4G LTE 2xMiMo Vehicular Antenna

Series: Jaguar

PART NUMBER: W1919

CHARTS

Efficiency(%)

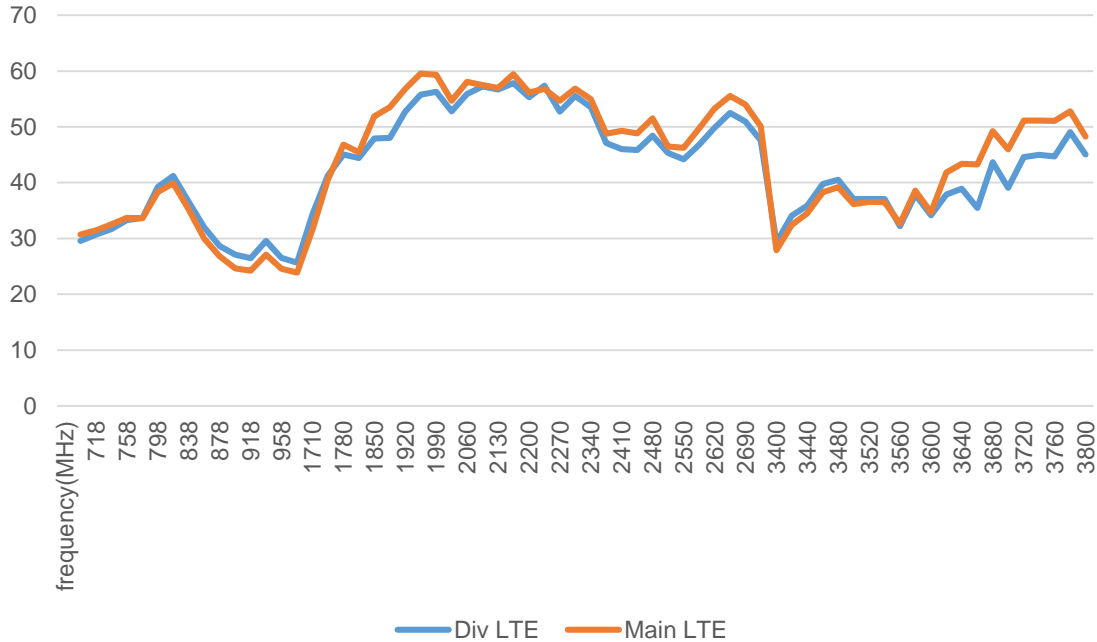

Peak Gain(dBi)

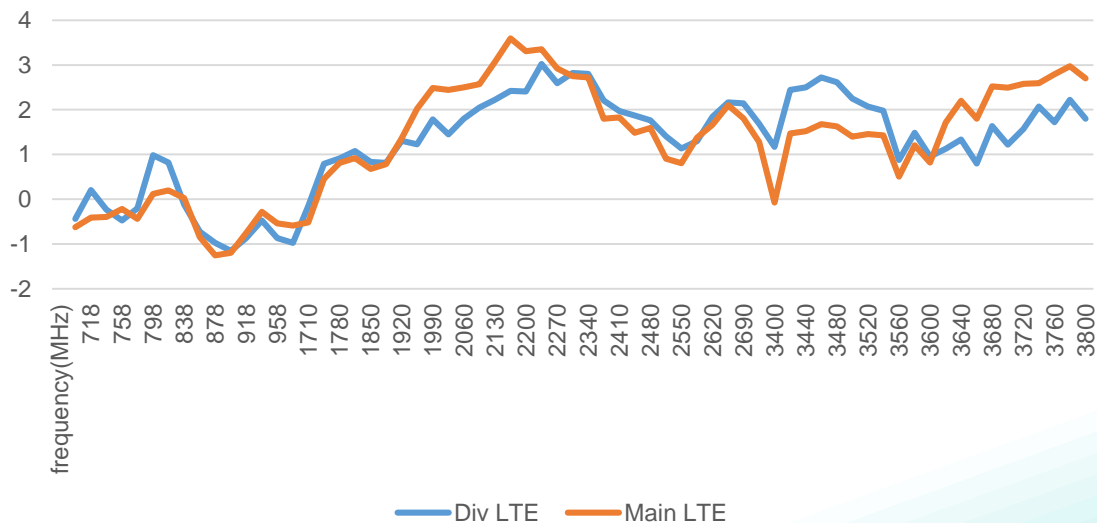

Note : Antenna measured in free space with 150mm cable

Issue: 1748P

In the effort to improve our products, we reserve the right to make changes judged to be necessary.

CONFIDENTIAL AND PROPRIETARY INFORMATION

This document contains confidential and proprietary information of Pulse Electronics, Inc. (Pulse) and is protected by copyright, trade secret and other state and federal laws. Its receipt or possession does not convey any rights to reproduce, disclose its contents, or to manufacture, use or sell anything it may describe. Reproduction, disclosure or use without specific written authorization of Pulse is strictly forbidden.

Preliminary



Description: 3G/4G LTE 2xMiMo Vehicular Antenna

Series: Jaguar

PART NUMBER: W1919

CHARTS

Gain Plots (Main LTE)

XY Plane

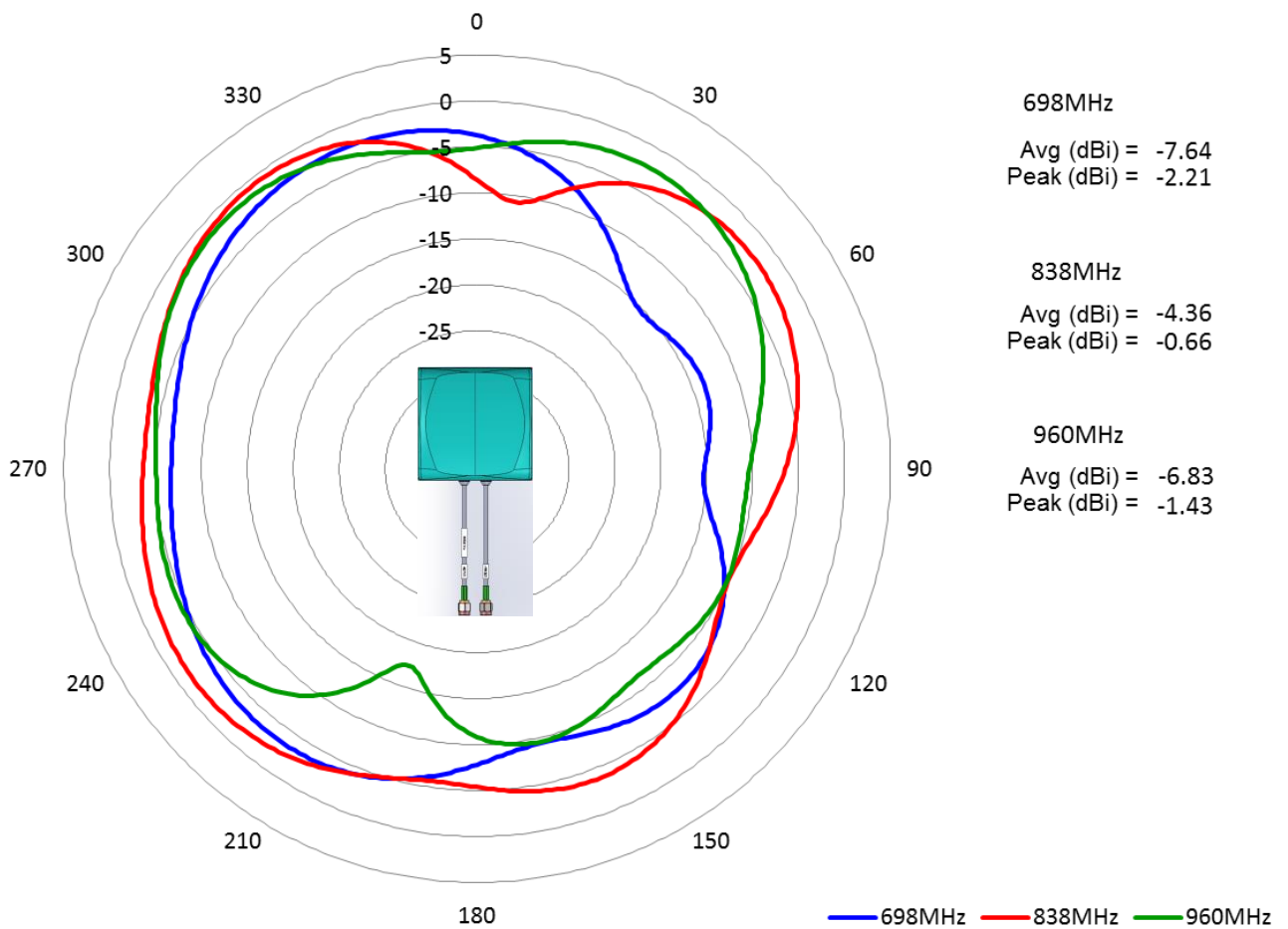

Note : Antenna measured in free space with 150mm cable

Issue: 1748P

In the effort to improve our products, we reserve the right to make changes judged to be necessary.
CONFIDENTIAL AND PROPRIETARY INFORMATION

This document contains confidential and proprietary information of Pulse Electronics, Inc. (Pulse) and is protected by copyright, trade secret and other state and federal laws. Its receipt or possession does not convey any rights to reproduce, disclose its contents, or to manufacture, use or sell anything it may describe. Reproduction, disclosure or use without specific written authorization of Pulse is strictly forbidden.

Preliminary



Description: 3G/4G LTE 2xMiMo Vehicular Antenna

Series: Jaguar

PART NUMBER: W1919

CHARTS

Gain Plots (Main LTE)

ZX Plane

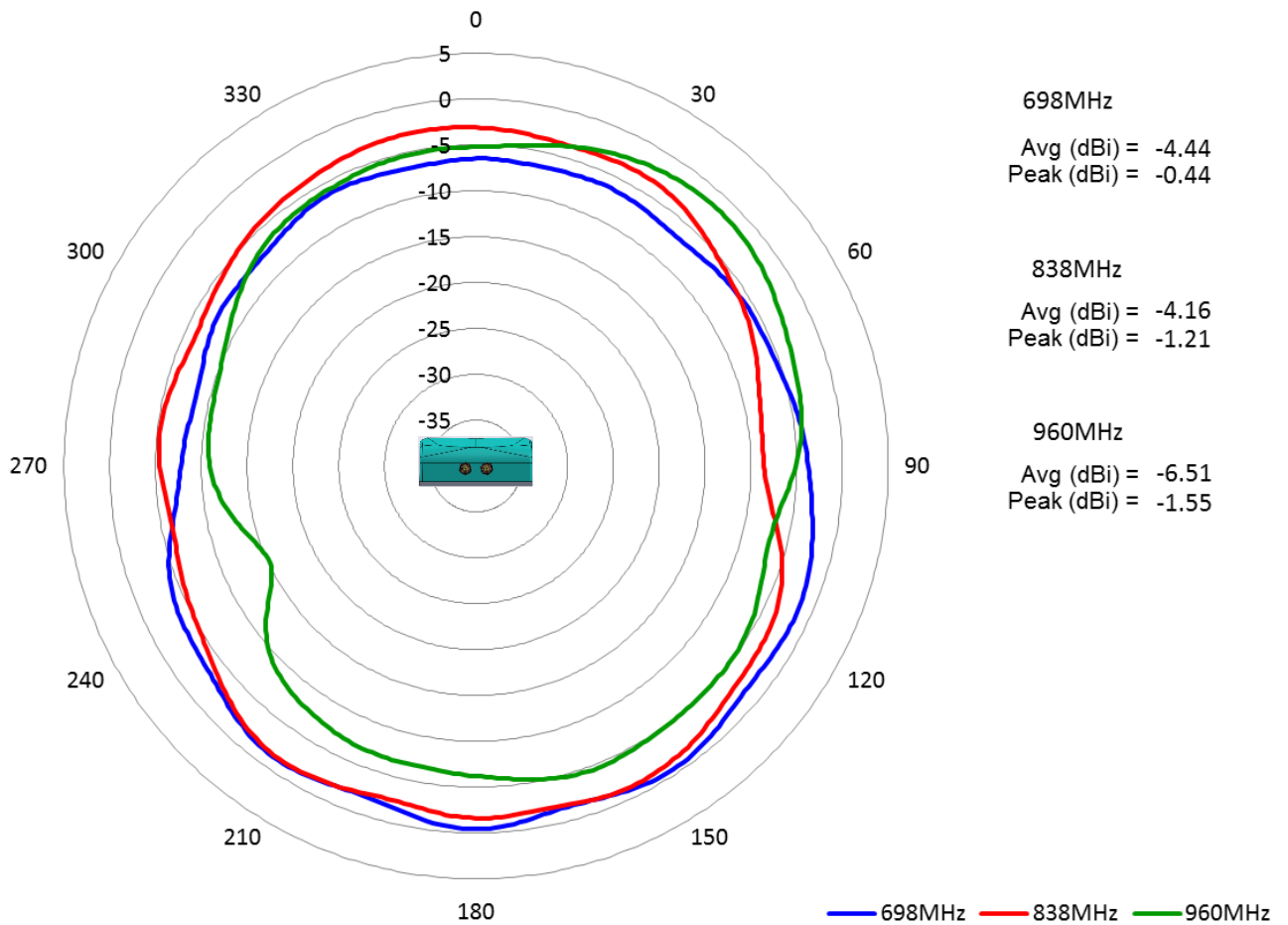

Note : Antenna measured in free space with 150mm cable

Issue: 1748P

In the effort to improve our products, we reserve the right to make changes judged to be necessary.

CONFIDENTIAL AND PROPRIETARY INFORMATION

This document contains confidential and proprietary information of Pulse Electronics, Inc. (Pulse) and is protected by copyright, trade secret and other state and federal laws. Its receipt or possession does not convey any rights to reproduce, disclose its contents, or to manufacture, use or sell anything it may describe. Reproduction, disclosure or use without specific written authorization of Pulse is strictly forbidden.

Preliminary



Description: 3G/4G LTE 2xMiMo Vehicular Antenna

Series: Jaguar

PART NUMBER: W1919

CHARTS

Gain Plots (Main LTE)

ZY Plane

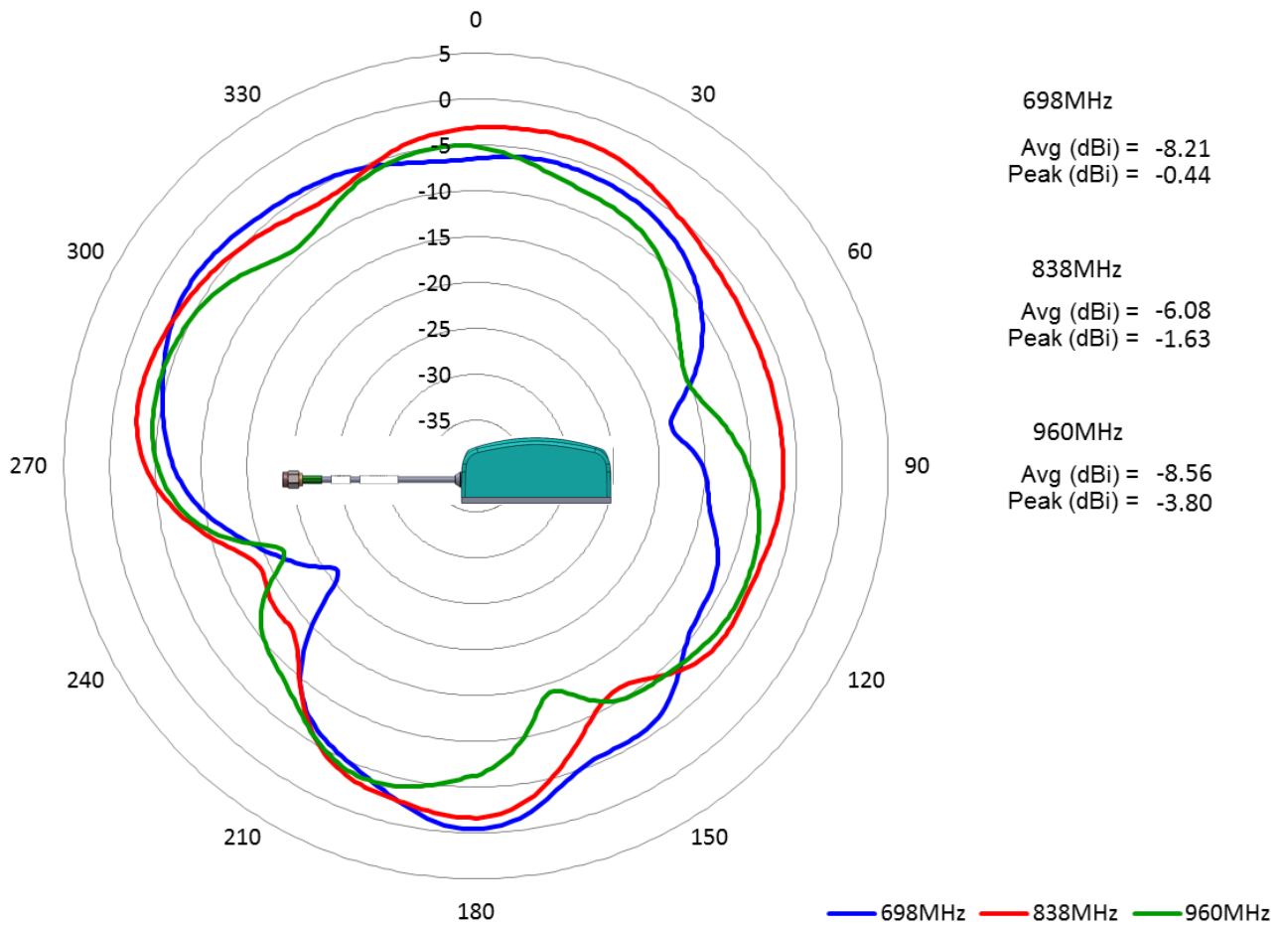

Note : Antenna measured in free space with 150mm cable

Issue: 1748P

In the effort to improve our products, we reserve the right to make changes judged to be necessary.
CONFIDENTIAL AND PROPRIETARY INFORMATION

This document contains confidential and proprietary information of Pulse Electronics, Inc. (Pulse) and is protected by copyright, trade secret and other state and federal laws. Its receipt or possession does not convey any rights to reproduce, disclose its contents, or to manufacture, use or sell anything it may describe. Reproduction, disclosure or use without specific written authorization of Pulse is strictly forbidden.

Preliminary



Description: 3G/4G LTE 2xMiMo Vehicular Antenna

Series: Jaguar

PART NUMBER: W1919

CHARTS

Gain Plots (Main LTE)

XY Plane

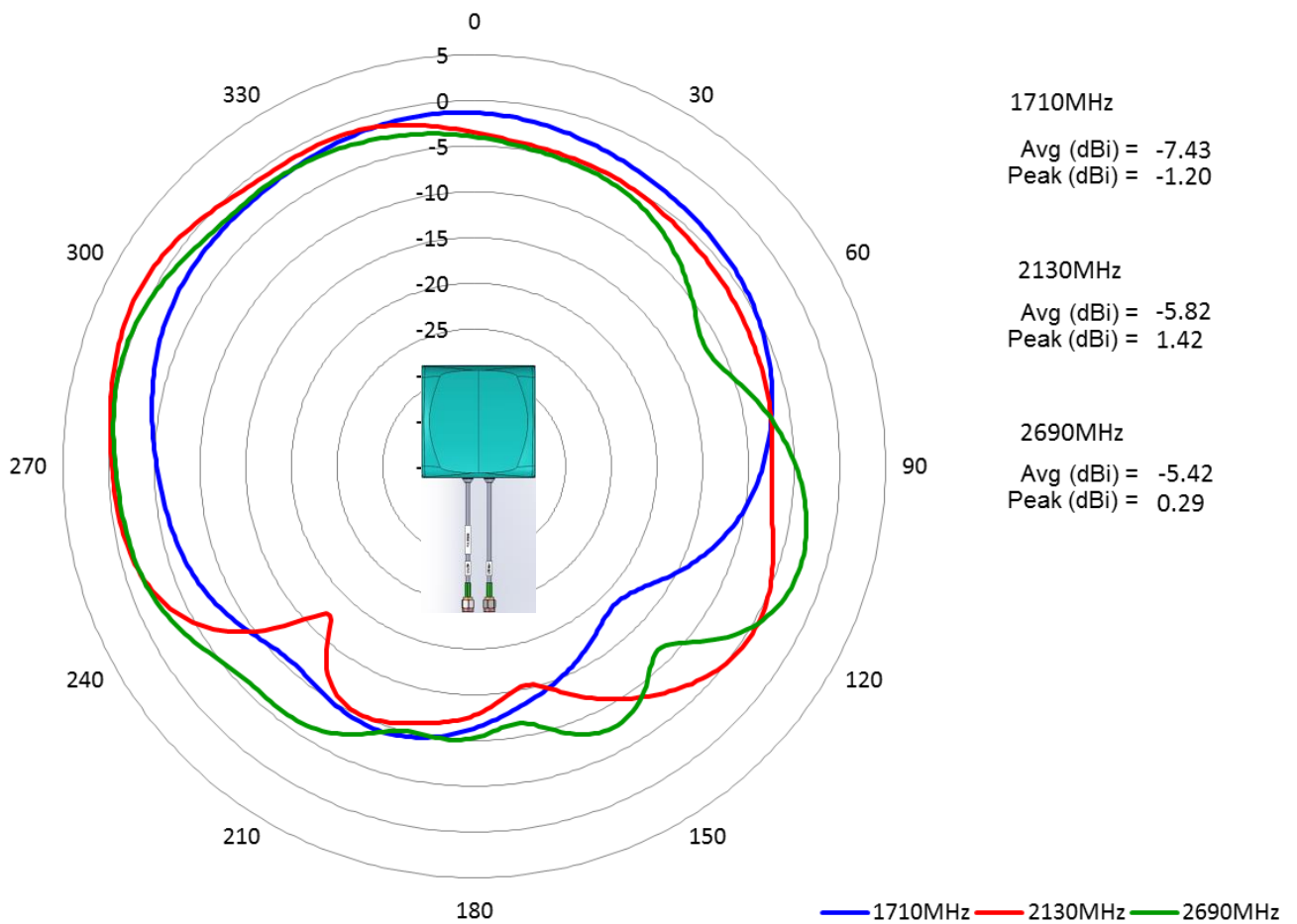

Note : Antenna measured in free space with 150mm cable

Issue: 1748P

In the effort to improve our products, we reserve the right to make changes judged to be necessary.

CONFIDENTIAL AND PROPRIETARY INFORMATION

This document contains confidential and proprietary information of Pulse Electronics, Inc. (Pulse) and is protected by copyright, trade secret and other state and federal laws. Its receipt or possession does not convey any rights to reproduce, disclose its contents, or to manufacture, use or sell anything it may describe. Reproduction, disclosure or use without specific written authorization of Pulse is strictly forbidden.

Preliminary



Description: 3G/4G LTE 2xMiMo Vehicular Antenna

Series: Jaguar

PART NUMBER: W1919

CHARTS

Gain Plots (Main LTE)

ZX Plane

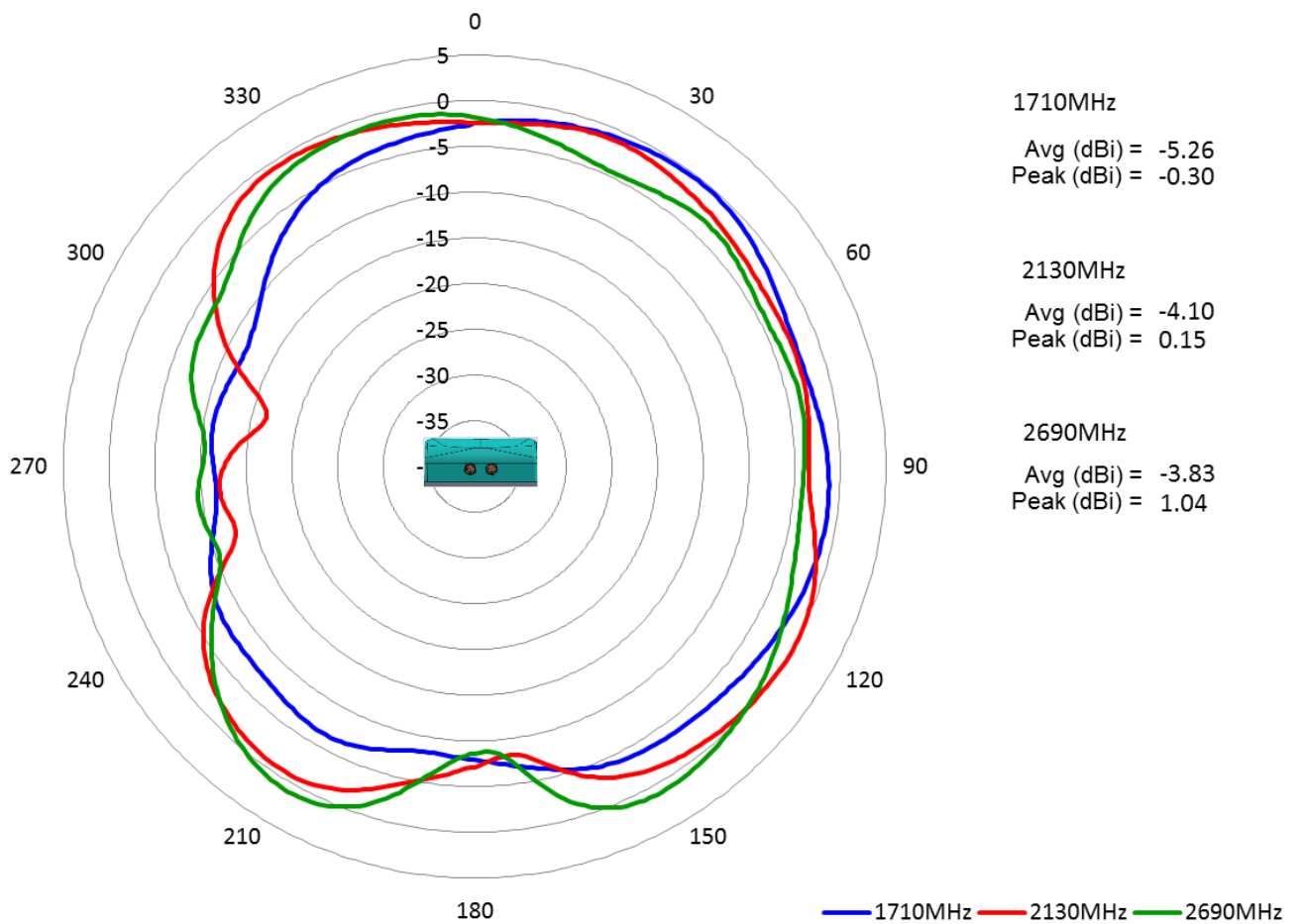

Note : Antenna measured in free space with 150mm cable

Issue: 1748P

In the effort to improve our products, we reserve the right to make changes judged to be necessary.
CONFIDENTIAL AND PROPRIETARY INFORMATION

This document contains confidential and proprietary information of Pulse Electronics, Inc. (Pulse) and is protected by copyright, trade secret and other state and federal laws. Its receipt or possession does not convey any rights to reproduce, disclose its contents, or to manufacture, use or sell anything it may describe. Reproduction, disclosure or use without specific written authorization of Pulse is strictly forbidden.

Preliminary



Description: 3G/4G LTE 2xMiMo Vehicular Antenna

Series: Jaguar

PART NUMBER: W1919

CHARTS

Gain Plots (Main LTE)

ZY Plane

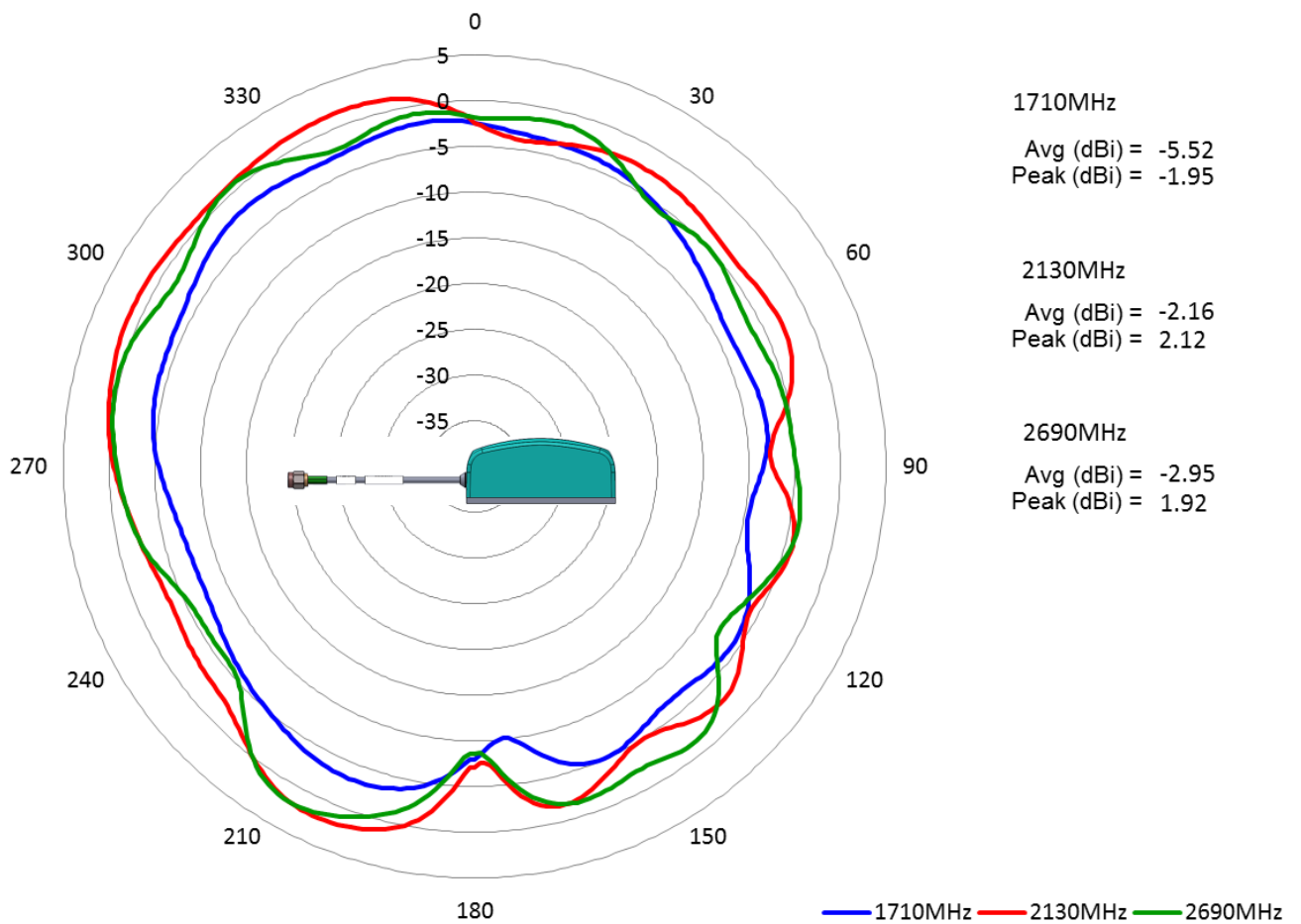

Note : Antenna measured in free space with 150mm cable

Issue: 1748P

In the effort to improve our products, we reserve the right to make changes judged to be necessary.
CONFIDENTIAL AND PROPRIETARY INFORMATION

This document contains confidential and proprietary information of Pulse Electronics, Inc. (Pulse) and is protected by copyright, trade secret and other state and federal laws. Its receipt or possession does not convey any rights to reproduce, disclose its contents, or to manufacture, use or sell anything it may describe. Reproduction, disclosure or use without specific written authorization of Pulse is strictly forbidden.

Preliminary



Description: 3G/4G LTE 2xMiMo Vehicular Antenna

Series: Jaguar

PART NUMBER: W1919

CHARTS

Gain Plots (Main LTE)

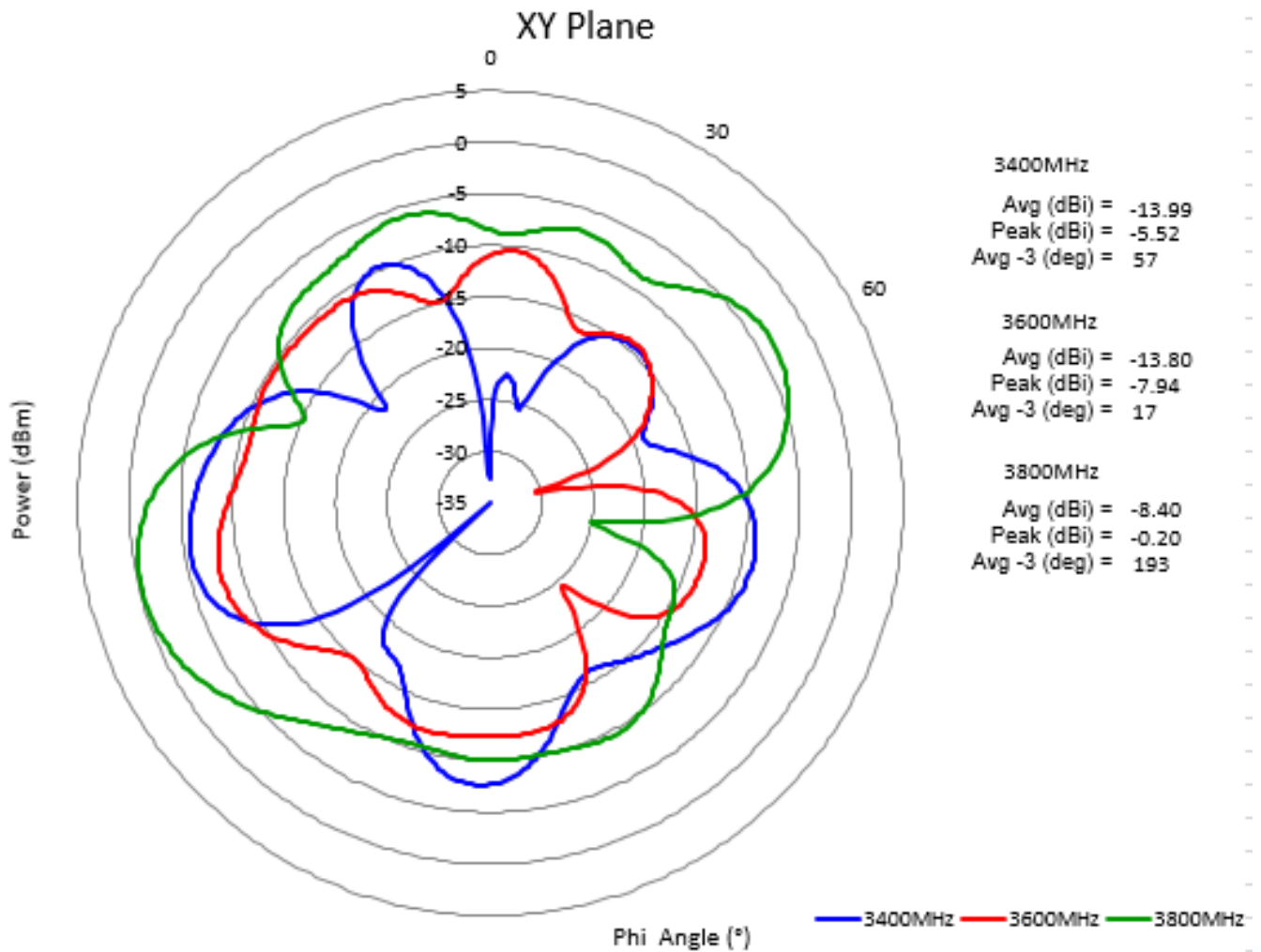

Note : Antenna measured in free space with 150mm cable

Issue: 1748P

In the effort to improve our products, we reserve the right to make changes judged to be necessary.
CONFIDENTIAL AND PROPRIETARY INFORMATION

This document contains confidential and proprietary information of Pulse Electronics, Inc. (Pulse) and is protected by copyright, trade secret and other state and federal laws. Its receipt or possession does not convey any rights to reproduce, disclose its contents, or to manufacture, use or sell anything it may describe. Reproduction, disclosure or use without specific written authorization of Pulse is strictly forbidden.

Preliminary

Description: 3G/4G LTE 2xMiMo Vehicular Antenna

Series: Jaguar

PART NUMBER: W1919

CHARTS

Gain Plots (Main LTE)

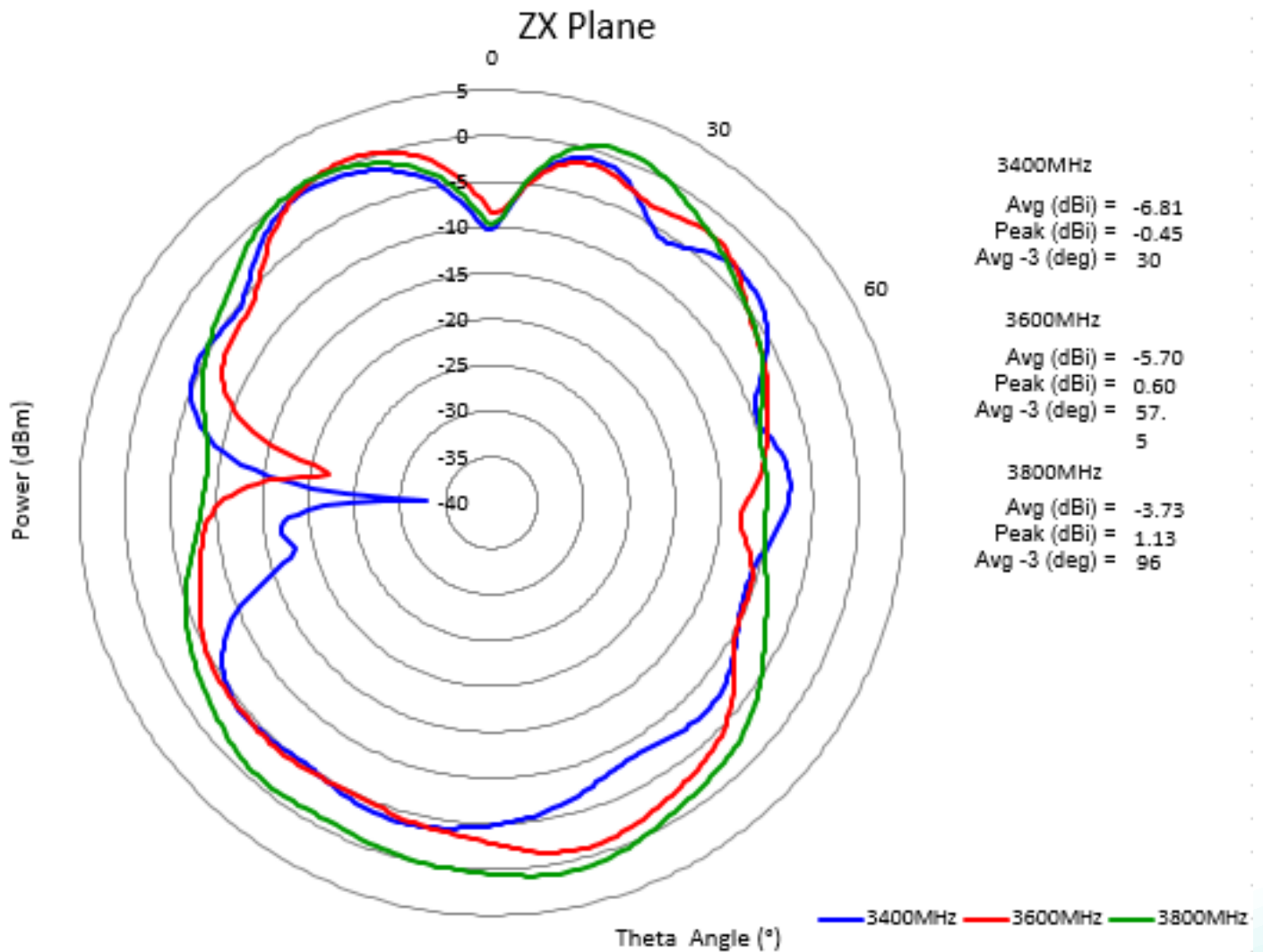

Note : Antenna measured in free space with 150mm cable

Issue: 1748P

In the effort to improve our products, we reserve the right to make changes judged to be necessary.
CONFIDENTIAL AND PROPRIETARY INFORMATION

This document contains confidential and proprietary information of Pulse Electronics, Inc. (Pulse) and is protected by copyright, trade secret and other state and federal laws. Its receipt or possession does not convey any rights to reproduce, disclose its contents, or to manufacture, use or sell anything it may describe. Reproduction, disclosure or use without specific written authorization of Pulse is strictly forbidden.

Preliminary

Description: 3G/4G LTE 2xMiMo Vehicular Antenna

Series: Jaguar

PART NUMBER: W1919

CHARTS

Gain Plots (Main LTE)

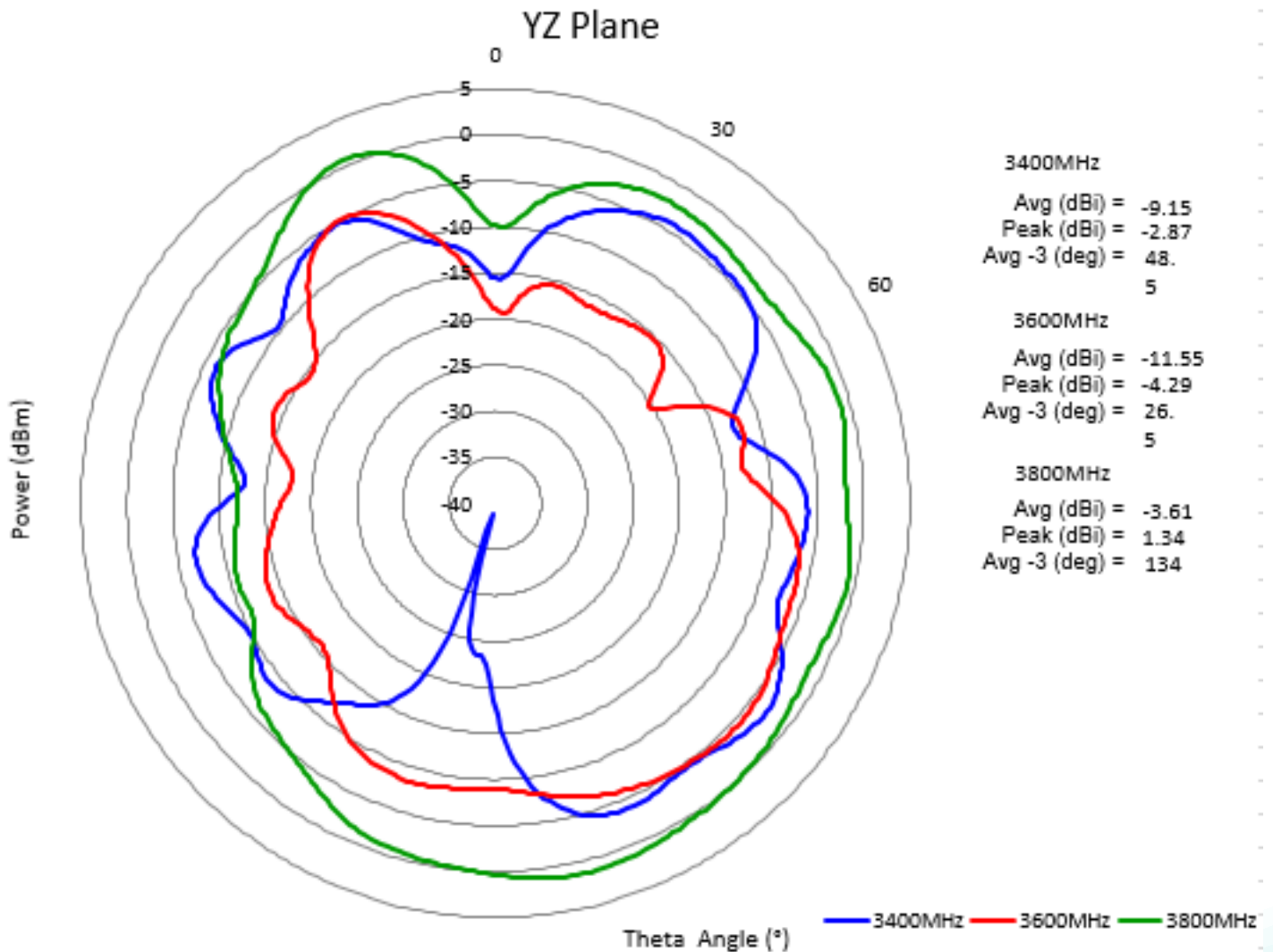

Note : Antenna measured in free space with 150mm cable

Issue: 1748P

In the effort to improve our products, we reserve the right to make changes judged to be necessary.
CONFIDENTIAL AND PROPRIETARY INFORMATION

This document contains confidential and proprietary information of Pulse Electronics, Inc. (Pulse) and is protected by copyright, trade secret and other state and federal laws. Its receipt or possession does not convey any rights to reproduce, disclose its contents, or to manufacture, use or sell anything it may describe. Reproduction, disclosure or use without specific written authorization of Pulse is strictly forbidden.

Preliminary

Description: 3G/4G LTE 2xMiMo Vehicular Antenna

Series: Jaguar

PART NUMBER: W1919

CHARTS

Gain Plots (Diversity LTE)

XY Plane

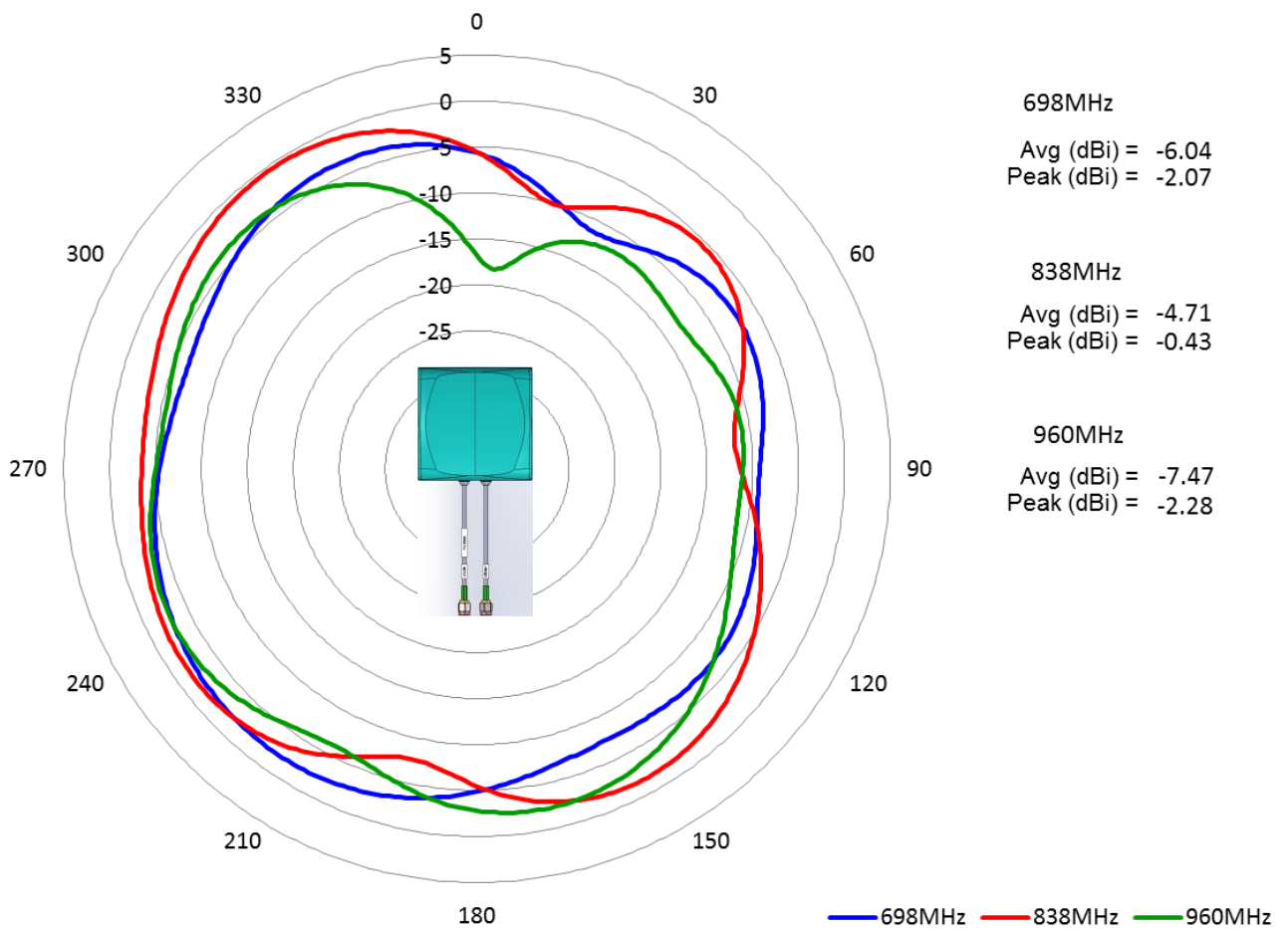

Note : Antenna measured in free space with 150mm cable

Issue: 1748P

In the effort to improve our products, we reserve the right to make changes judged to be necessary.
CONFIDENTIAL AND PROPRIETARY INFORMATION

This document contains confidential and proprietary information of Pulse Electronics, Inc. (Pulse) and is protected by copyright, trade secret and other state and federal laws. Its receipt or possession does not convey any rights to reproduce, disclose its contents, or to manufacture, use or sell anything it may describe. Reproduction, disclosure or use without specific written authorization of Pulse is strictly forbidden.

Preliminary



Description: 3G/4G LTE 2xMiMo Vehicular Antenna

Series: Jaguar

PART NUMBER: W1919

CHARTS

Gain Plots (Diversity LTE)

ZX Plane

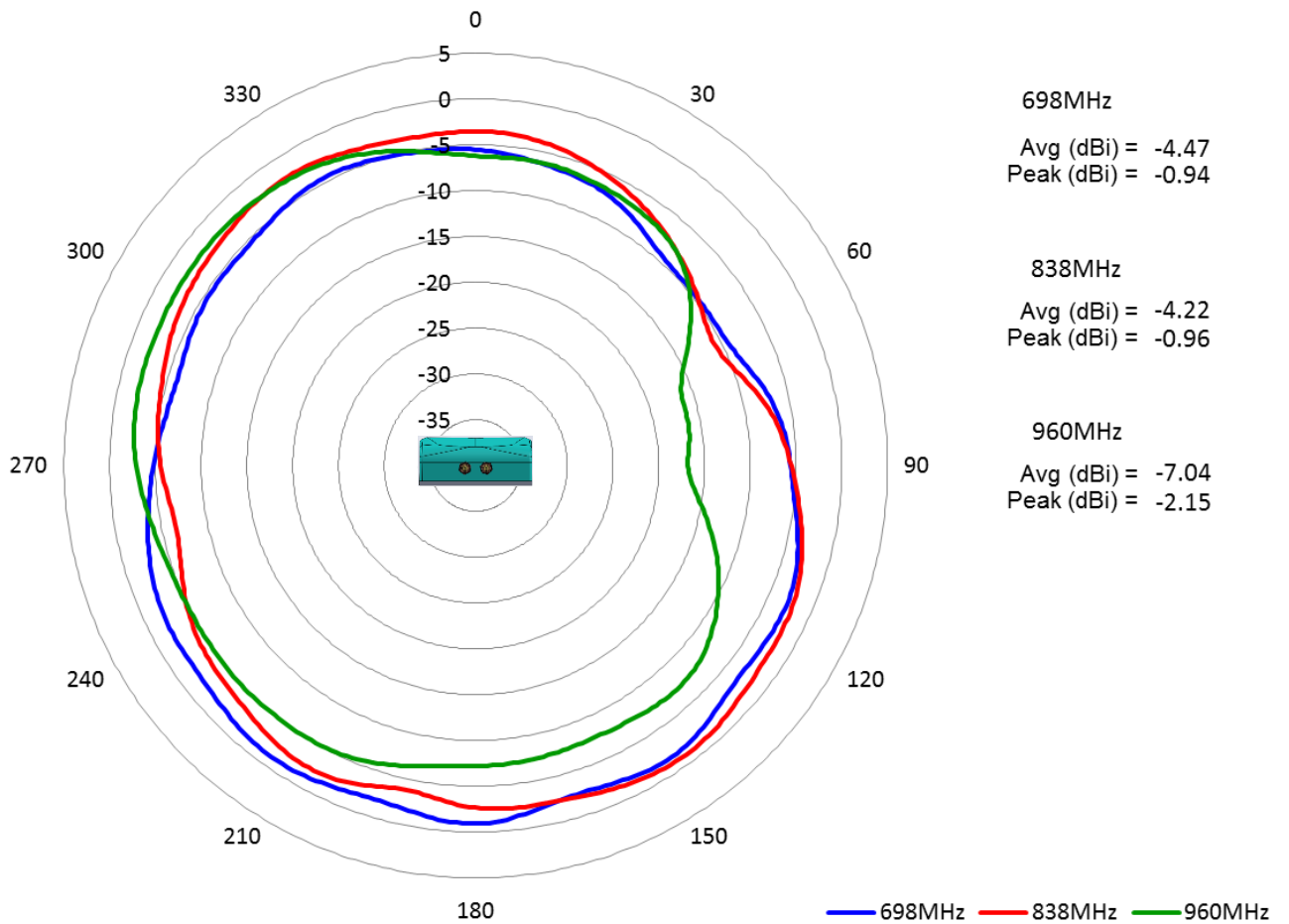

Note : Antenna measured in free space with 150mm cable

Issue: 1748P

In the effort to improve our products, we reserve the right to make changes judged to be necessary.
CONFIDENTIAL AND PROPRIETARY INFORMATION

This document contains confidential and proprietary information of Pulse Electronics, Inc. (Pulse) and is protected by copyright, trade secret and other state and federal laws. Its receipt or possession does not convey any rights to reproduce, disclose its contents, or to manufacture, use or sell anything it may describe. Reproduction, disclosure or use without specific written authorization of Pulse is strictly forbidden.

Preliminary



Description: 3G/4G LTE 2xMiMo Vehicular Antenna

Series: Jaguar

PART NUMBER: W1919

CHARTS

Gain Plots (Diversity LTE)

ZY Plane

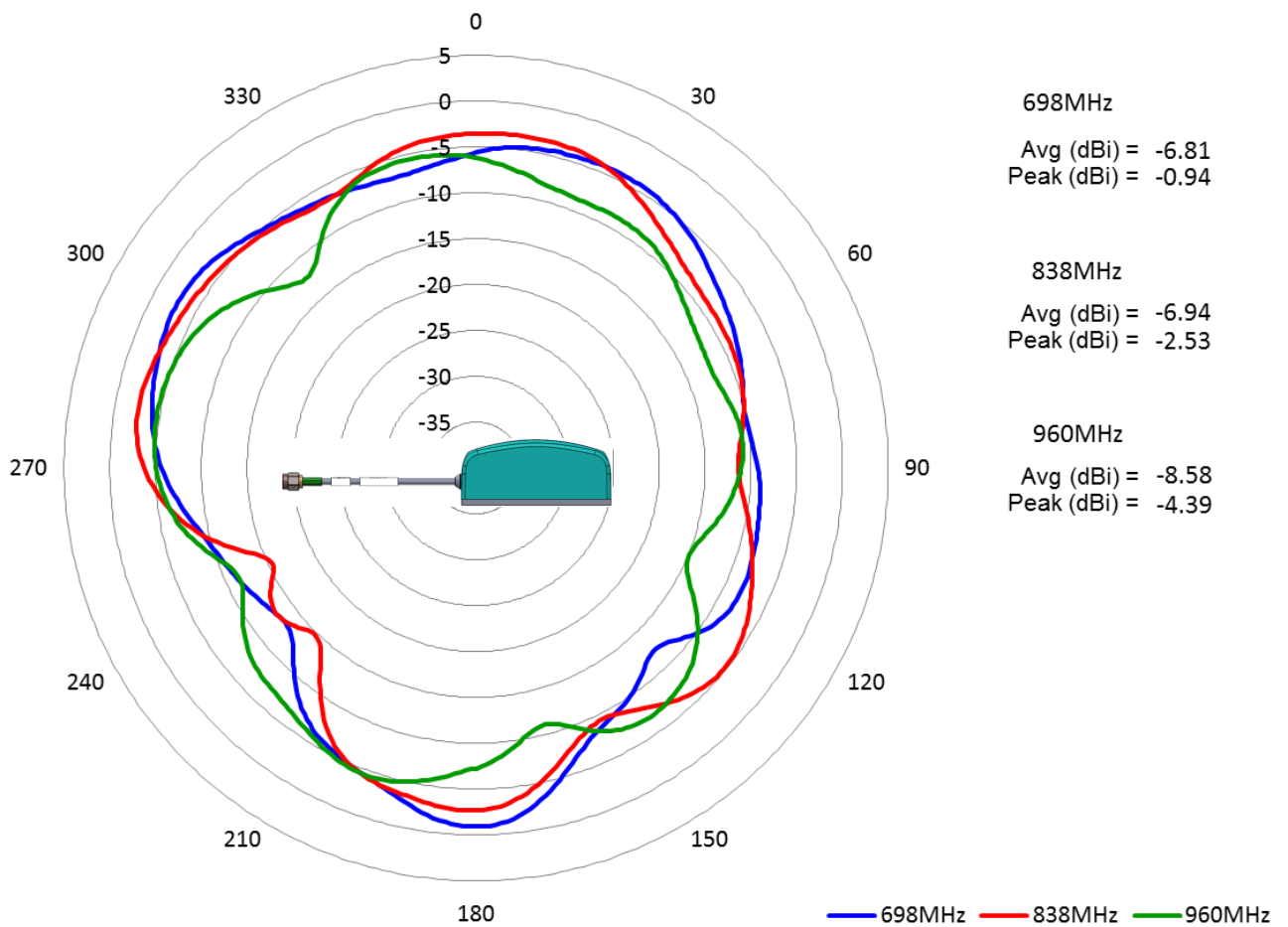

Note : Antenna measured in free space with 150mm cable

Issue: 1748P

In the effort to improve our products, we reserve the right to make changes judged to be necessary.
CONFIDENTIAL AND PROPRIETARY INFORMATION

This document contains confidential and proprietary information of Pulse Electronics, Inc. (Pulse) and is protected by copyright, trade secret and other state and federal laws. Its receipt or possession does not convey any rights to reproduce, disclose its contents, or to manufacture, use or sell anything it may describe. Reproduction, disclosure or use without specific written authorization of Pulse is strictly forbidden.

Preliminary



Description: 3G/4G LTE 2xMiMo Vehicular Antenna

Series: Jaguar

PART NUMBER: W1919

CHARTS

Gain Plots (Diversity LTE)

XY Plane

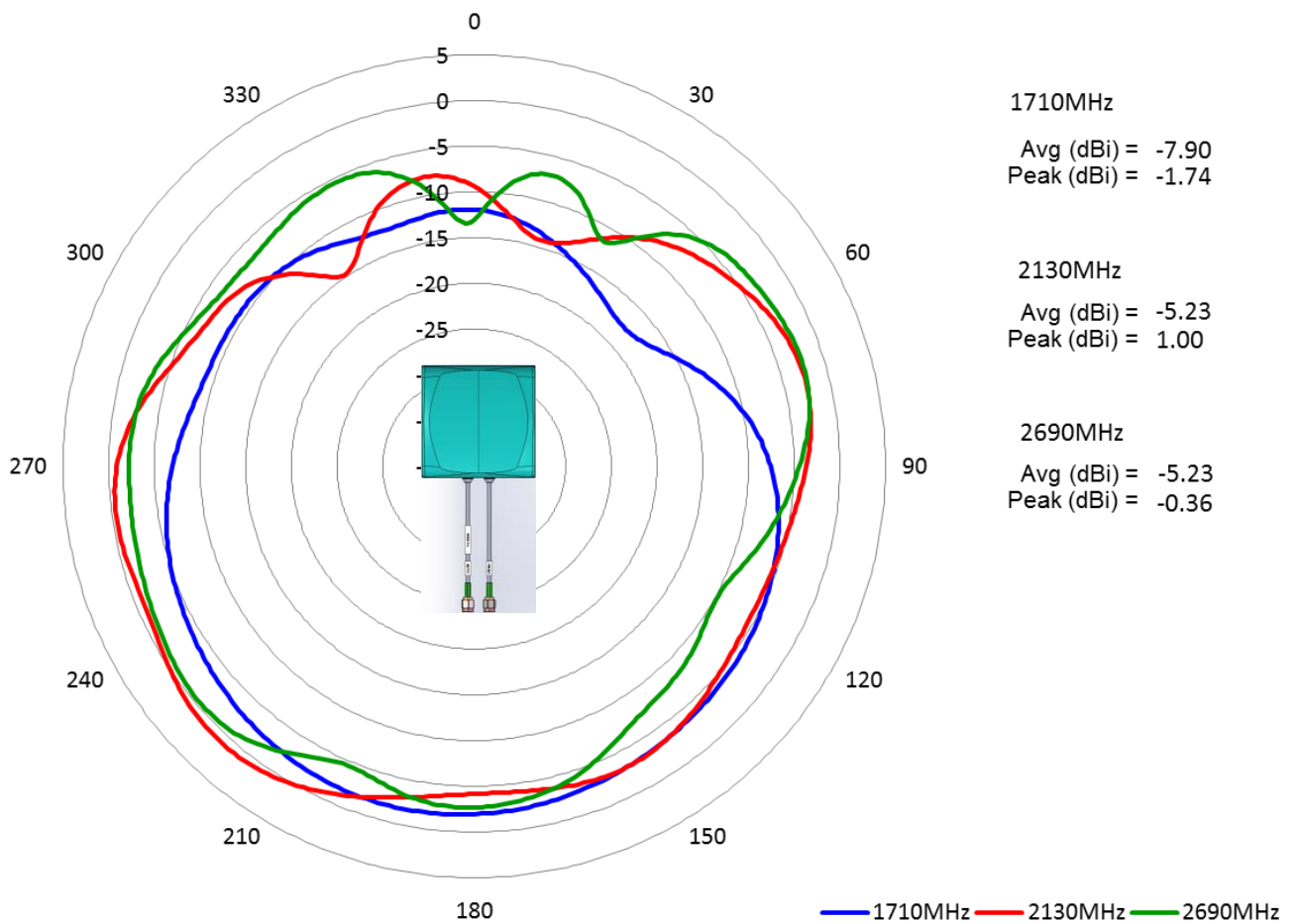

Note : Antenna measured in free space with 150mm cable

Issue: 1748P

In the effort to improve our products, we reserve the right to make changes judged to be necessary.
CONFIDENTIAL AND PROPRIETARY INFORMATION

This document contains confidential and proprietary information of Pulse Electronics, Inc. (Pulse) and is protected by copyright, trade secret and other state and federal laws. Its receipt or possession does not convey any rights to reproduce, disclose its contents, or to manufacture, use or sell anything it may describe. Reproduction, disclosure or use without specific written authorization of Pulse is strictly forbidden.

Preliminary



Description: 3G/4G LTE 2xMiMo Vehicular Antenna

Series: Jaguar

PART NUMBER: W1919

CHARTS

Gain Plots (Diversity LTE)

ZX Plane

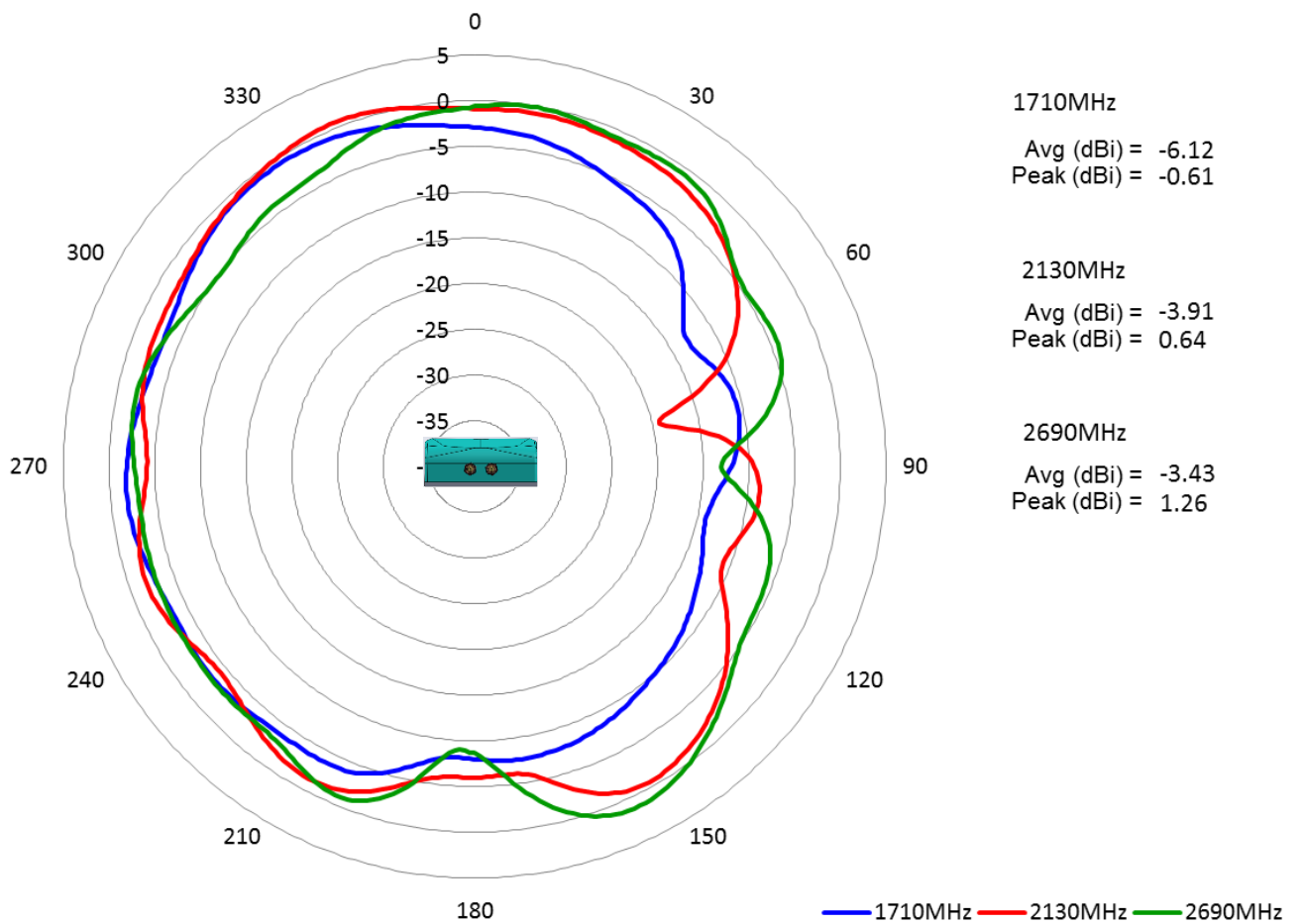

Note : Antenna measured in free space with 150mm cable

Issue: 1748P

In the effort to improve our products, we reserve the right to make changes judged to be necessary.
CONFIDENTIAL AND PROPRIETARY INFORMATION

This document contains confidential and proprietary information of Pulse Electronics, Inc. (Pulse) and is protected by copyright, trade secret and other state and federal laws. Its receipt or possession does not convey any rights to reproduce, disclose its contents, or to manufacture, use or sell anything it may describe. Reproduction, disclosure or use without specific written authorization of Pulse is strictly forbidden.

Preliminary



Description: 3G/4G LTE 2xMiMo Vehicular Antenna

Series: Jaguar

PART NUMBER: W1919

CHARTS

Gain Plots (Diversity LTE)

ZY Plane

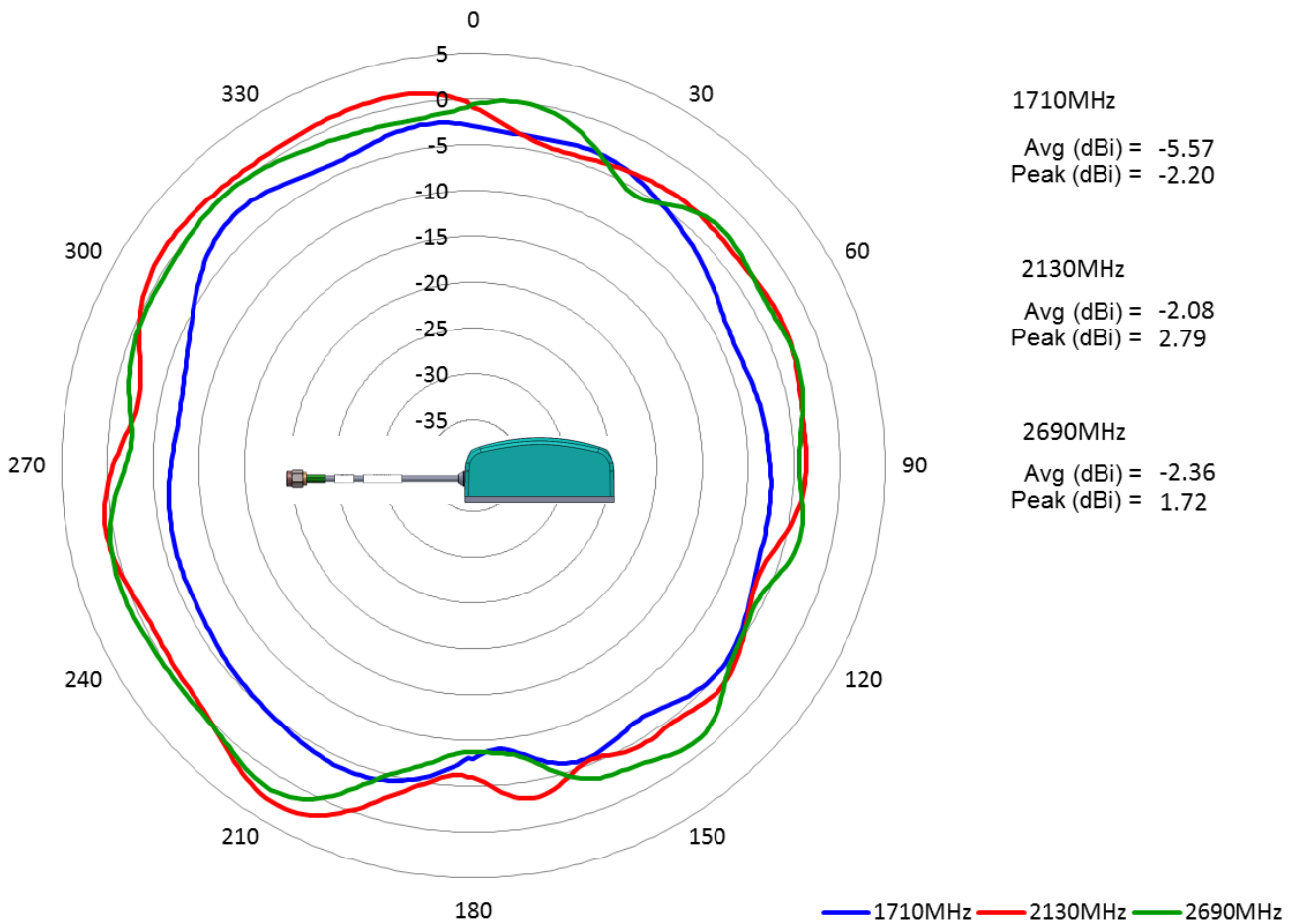

Note : Antenna measured in free space with 150mm cable

Issue: 1748P

In the effort to improve our products, we reserve the right to make changes judged to be necessary.
CONFIDENTIAL AND PROPRIETARY INFORMATION

This document contains confidential and proprietary information of Pulse Electronics, Inc. (Pulse) and is protected by copyright, trade secret and other state and federal laws. Its receipt or possession does not convey any rights to reproduce, disclose its contents, or to manufacture, use or sell anything it may describe. Reproduction, disclosure or use without specific written authorization of Pulse is strictly forbidden.

Preliminary



Description: 3G/4G LTE 2xMiMo Vehicular Antenna

Series: Jaguar

PART NUMBER: W1919

CHARTS

Gain Plots (Diversity LTE)

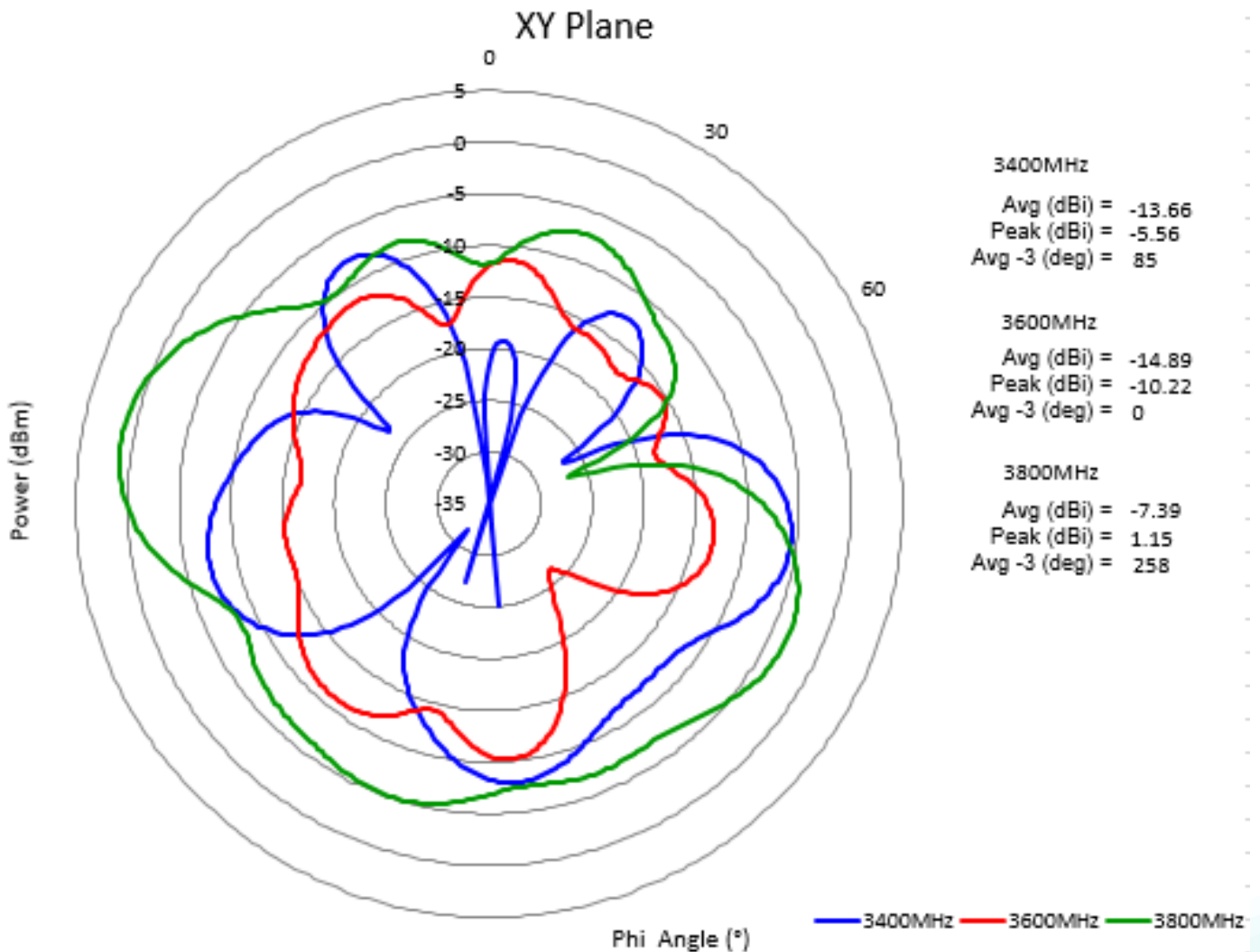

Note : Antenna measured in free space with 150mm cable

Issue: 1748P

In the effort to improve our products, we reserve the right to make changes judged to be necessary.
CONFIDENTIAL AND PROPRIETARY INFORMATION

This document contains confidential and proprietary information of Pulse Electronics, Inc. (Pulse) and is protected by copyright, trade secret and other state and federal laws. Its receipt or possession does not convey any rights to reproduce, disclose its contents, or to manufacture, use or sell anything it may describe. Reproduction, disclosure or use without specific written authorization of Pulse is strictly forbidden.

Preliminary

Description: 3G/4G LTE 2xMiMo Vehicular Antenna

Series: Jaguar

PART NUMBER: W1919

CHARTS

Gain Plots (Diversity LTE)

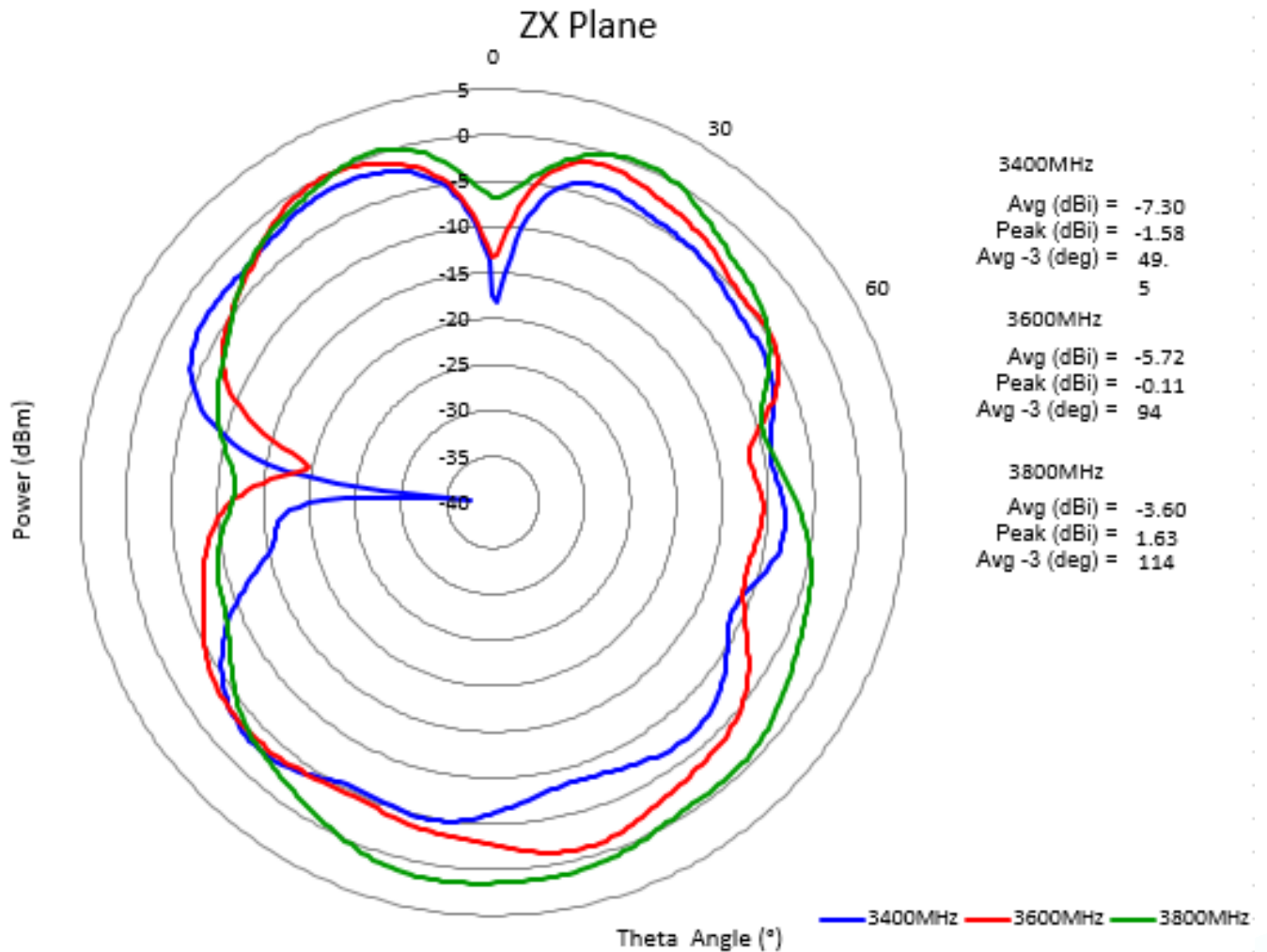

Note : Antenna measured in free space with 150mm cable

Issue: 1748P

In the effort to improve our products, we reserve the right to make changes judged to be necessary.
CONFIDENTIAL AND PROPRIETARY INFORMATION

This document contains confidential and proprietary information of Pulse Electronics, Inc. (Pulse) and is protected by copyright, trade secret and other state and federal laws. Its receipt or possession does not convey any rights to reproduce, disclose its contents, or to manufacture, use or sell anything it may describe. Reproduction, disclosure or use without specific written authorization of Pulse is strictly forbidden.

Preliminary

Description: 3G/4G LTE 2xMiMo Vehicular Antenna

Series: Jaguar

PART NUMBER: W1919

CHARTS

Gain Plots (Diversity LTE)

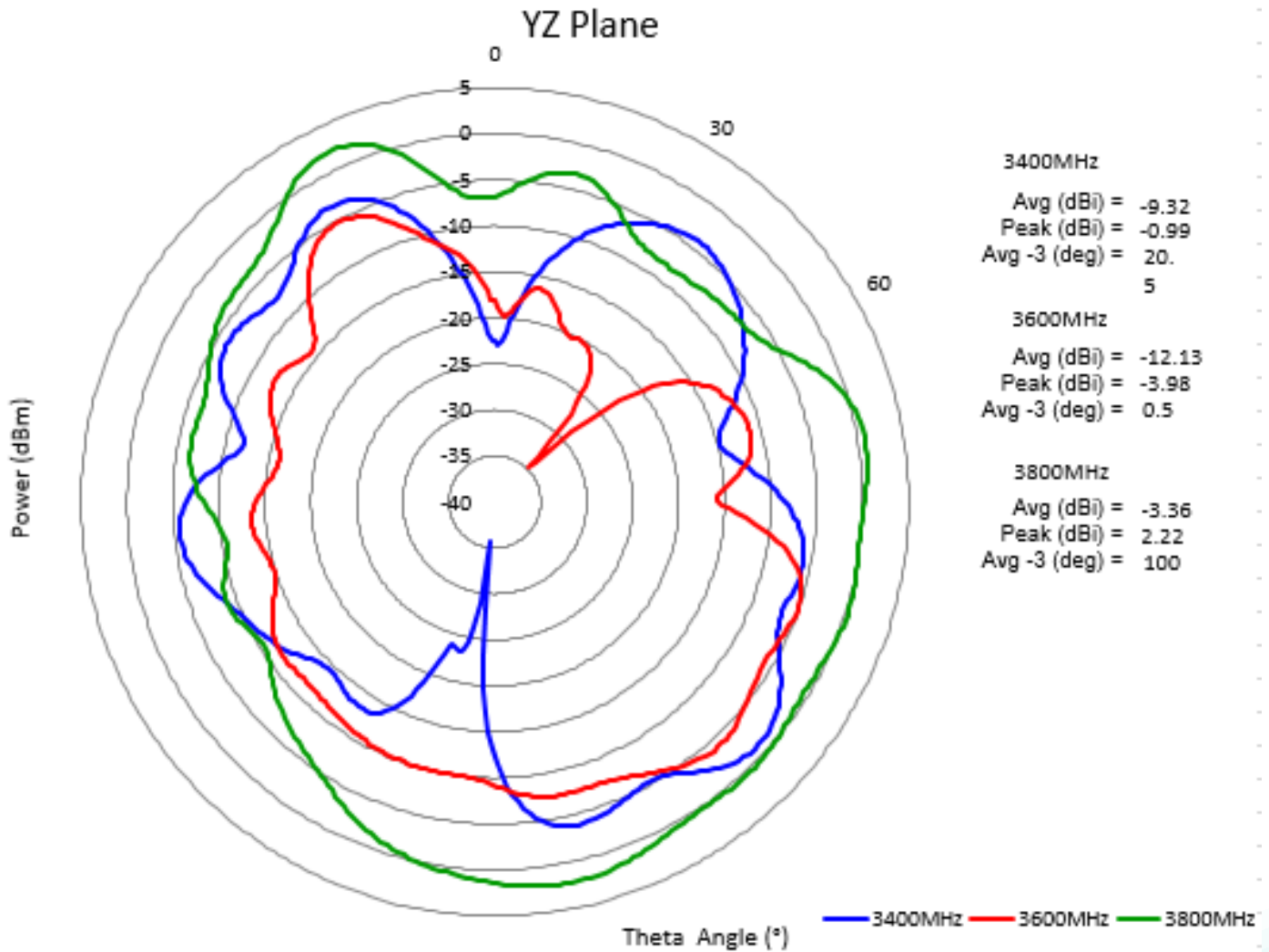

Note : Antenna measured in free space with 150mm cable

Issue: 1748P

In the effort to improve our products, we reserve the right to make changes judged to be necessary.
CONFIDENTIAL AND PROPRIETARY INFORMATION

This document contains confidential and proprietary information of Pulse Electronics, Inc. (Pulse) and is protected by copyright, trade secret and other state and federal laws. Its receipt or possession does not convey any rights to reproduce, disclose its contents, or to manufacture, use or sell anything it may describe. Reproduction, disclosure or use without specific written authorization of Pulse is strictly forbidden.

Preliminary

Series: Jaguar

Description: 3G/4G LTE 2xMiMo Vehicular Antenna

PART NUMBER: W1919

PACKAGING

1pcs antennas per foam bag

12pcs antennas per package box

Package box: 558mm*386mm*210mm

Issue: 1748P

In the effort to improve our products, we reserve the right to make changes judged to be necessary.

CONFIDENTIAL AND PROPRIETARY INFORMATION

This document contains confidential and proprietary information of Pulse Electronics, Inc. (Pulse) and is protected by copyright, trade secret and other state and federal laws. Its receipt or possession does not convey any rights to reproduce, disclose its contents, or to manufacture, use or sell anything it may describe. Reproduction, disclosure or use without specific written authorization of Pulse is strictly forbidden.

Preliminary



Mouser Electronics

Authorized Distributor

Click to View Pricing, Inventory, Delivery & Lifecycle Information:

[Pulse:](#)

[W1919](#)