

Features

- $BV_{CEO} > 45V$
- Low profile 0.4mm high package for thin applications
- Ultra-Small Surface Mount Package
- **Totally Lead-Free & Fully RoHS compliant (Notes 1 & 2)**
- **Halogen and Antimony Free. "Green" Device (Note 3)**
- **Qualified to AEC-Q101 Standards for High Reliability**

Mechanical Data

- Case: X2-DFN1310-6
- Nominal package height: 0.4mm
- Case Material: Molded Plastic, "Green" Molding Compound.
- UL Flammability Classification Rating 94V-0
- Moisture Sensitivity: Level 1 per J-STD-020
- Terminals: Finish - NiPdAu, Solderable per MIL-STD-202, Method 208 
- Weight: 0.0015 grams (approximate)

X2-DFN1310-6

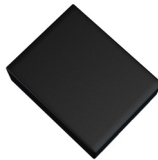

Top View

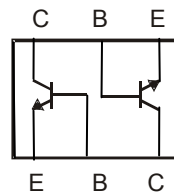

Device Schematic
Top View

Ordering Information (Note 4)

Part Number	Marking	Reel Size (inches)	Tape Width (mm)	Quantity per Reel
BC847CDLP-7	1M	7	8	3000

- Notes:
1. No purposely added lead. Fully EU Directive 2002/95/EC (RoHS) & 2011/65/EU (RoHS 2) compliant.
 2. See http://www.diodes.com/quality/lead_free.html for more information about Diodes Incorporated's definitions of Halogen- and Antimony-free, "Green" and Lead-free.
 3. Halogen- and Antimony-free "Green" products are defined as those which contain <900ppm bromine, <900ppm chlorine (<1500ppm total Br + Cl) and <1000ppm antimony compounds.
 4. For packaging details, go to our website at <http://www.diodes.com/products/packages.html>.

Marking Information



(Top View)

1M = Product Type Marking Code

Maximum Ratings (@T_A = +25°C unless otherwise specified.)

Characteristic	Symbol	Value	Unit
Collector-Base Voltage	V _{CB0}	50	V
Collector-Emitter Voltage	V _{CE0}	45	V
Emitter-Base Voltage	V _{EB0}	6	V
Collector Current	I _C	100	mA

Thermal Characteristics – Total Device (@T_A = +25°C unless otherwise specified.)

Characteristic	Symbol	Value	Unit
Power Dissipation (Note 5) Total Device	P _D	350	mW
Thermal Resistance, Junction to Ambient (Note 5)	R _{θJA}	357	°C/W
Operating and Storage Temperature Range	T _J , T _{STG}	-65 to +150	°C

Note: 5. For a device surface mounted on minimum recommended pad layout FR-4 PCB with single sided 1oz copper, in still air conditions; the device is measured when operating in a steady-state condition.

Thermal Characteristics – Total Device

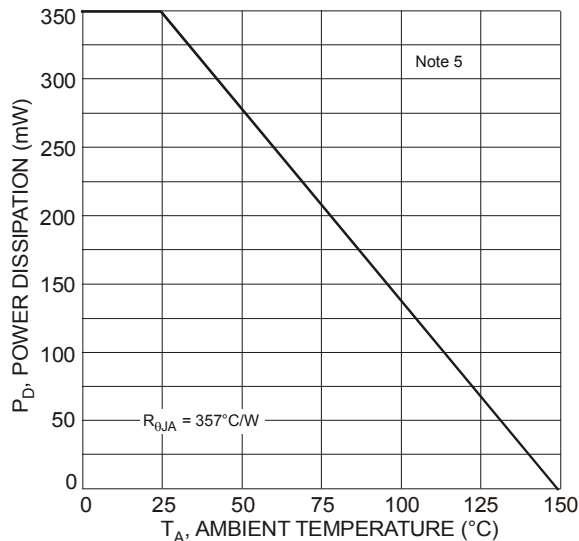

Figure 1 Power Dissipation vs. Ambient Temperature

Electrical Characteristics (@ $T_A = +25^\circ\text{C}$ unless otherwise specified.)

Characteristic (Note 6)	Symbol	Min	Typ	Max	Unit	Test Condition
Collector-Base Breakdown Voltage	BV_{CBO}	50	—	—	V	$I_C = 100\mu\text{A}, I_B = 0$
Collector-Emitter Breakdown Voltage	BV_{CEO}	45	—	—	V	$I_C = 10\text{mA}, I_B = 0$
Emitter-Base Breakdown Voltage	BV_{EBO}	6	—	—	V	$I_E = 100\mu\text{A}, I_C = 0$
DC Current Gain	h_{FE}	420	650	800	—	$V_{CE} = 5.0\text{V}, I_C = 2.0\text{mA}$
Collector-Emitter Saturation Voltage	$V_{CE(sat)}$	—	55 130	250 600	mV	$I_C = 10\text{mA}, I_B = 0.5\text{mA}$ $I_C = 100\text{mA}, I_B = 5.0\text{mA}$
Base-Emitter Saturation Voltage	$V_{BE(sat)}$	—	700 900	—	mV	$I_C = 10\text{mA}, I_B = 0.5\text{mA}$ $I_C = 100\text{mA}, I_B = 5.0\text{mA}$
Base-Emitter Voltage	$V_{BE(on)}$	580 —	660 —	700 770	mV	$V_{CE} = 5.0\text{V}, I_C = 2.0\text{mA}$ $V_{CE} = 5.0\text{V}, I_C = 10\text{mA}$
Collector-Cutoff Current	I_{CES}	—	—	15	nA	$V_{CE} = 50\text{V}$
Collector-Cutoff Current	I_{CBO}	—	—	15 5	nA μA	$V_{CB} = 30\text{V}$ $V_{CB} = 30\text{V}, T_A = +150^\circ\text{C}$
Gain Bandwidth Product	f_T	100	—	—	MHz	$V_{CE} = 5.0\text{V}, I_C = 10\text{mA},$ $f = 100\text{MHz}$
Collector-Base Capacitance	C_{CBO}	—	2.0	—	pF	$V_{CB} = 10\text{V}, f = 1.0\text{MHz}$

Note: 6. Measured under pulsed conditions. Pulse width $\leq 300\mu\text{s}$. Duty cycle $\leq 2\%$.

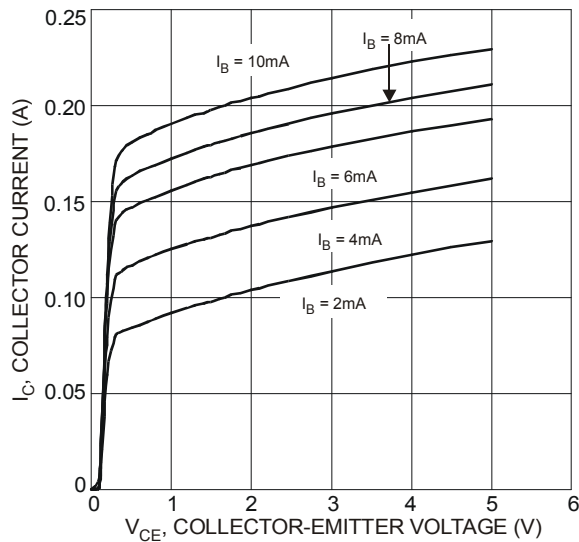

Figure 2 Typical Collector Current vs. Collector-Emitter Voltage

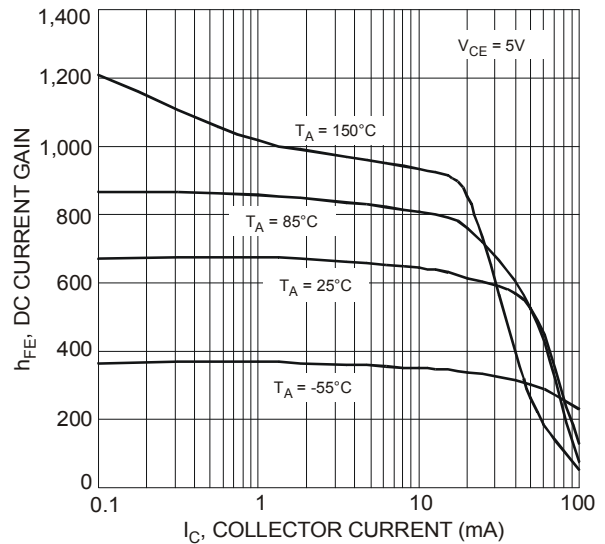

Figure 3 Typical DC Current Gain vs. Collector Current

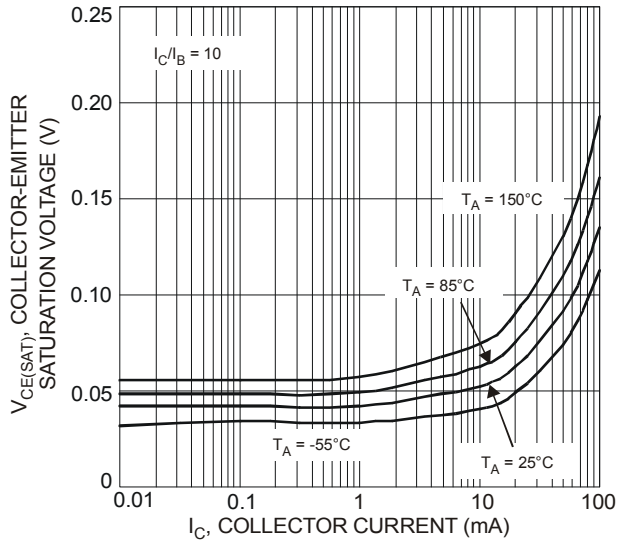

Figure 4 Typical Collector-Emitter Saturation Voltage vs. Collector Current

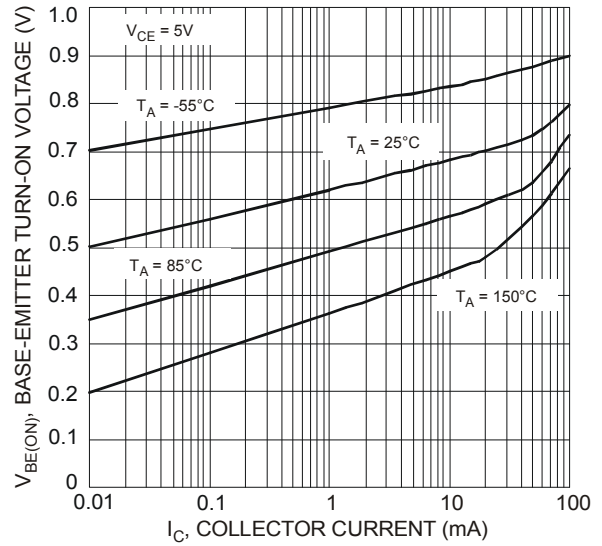

Figure 5 Typical Base-Emitter Turn-On Voltage vs. Collector Current

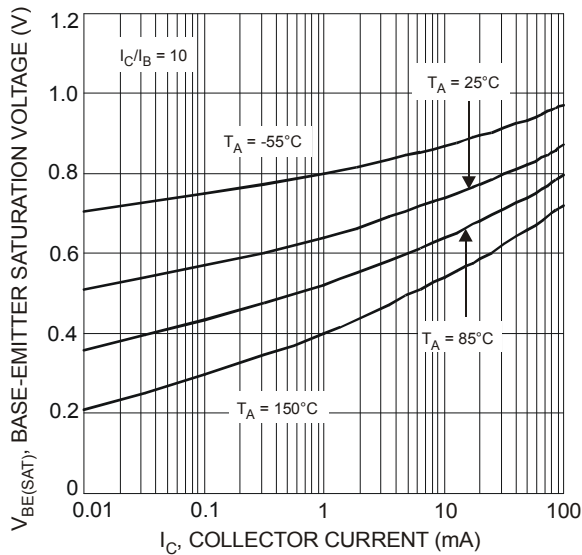

Figure 6 Typical Base-Emitter Saturation Voltage vs. Collector Current

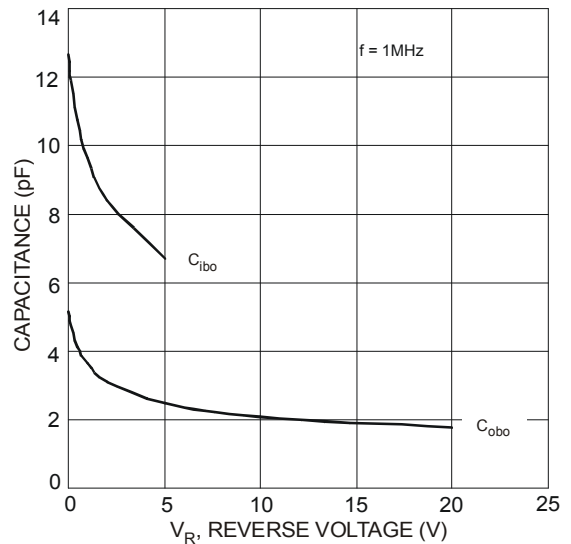

Figure 7 Typical Capacitance Characteristics

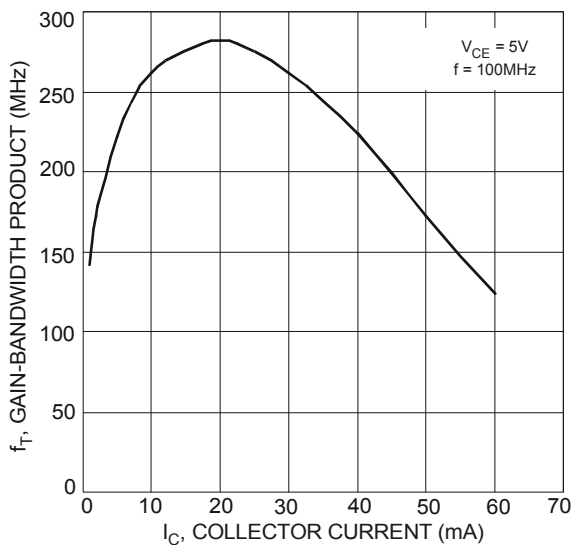
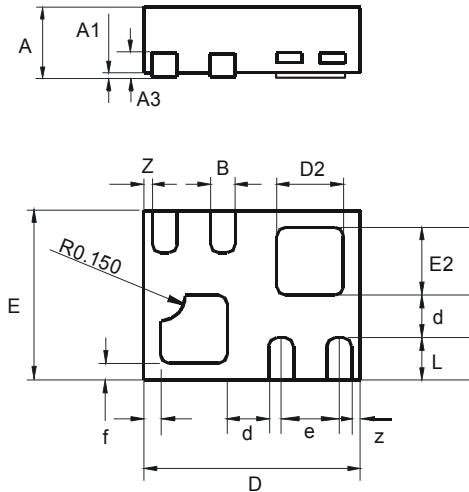

Figure 8 Typical Gain-Bandwidth Product vs. Collector Current

Package Outline Dimensions

Please see AP02002 at <http://www.diodes.com/datasheets/ap02002.pdf> for latest version.



X2-DFN1310-6			
Dim	Min	Max	Typ
A	—	0.40	—
A1	0	0.05	0.02
A3	—	—	0.13
b	0.10	0.20	0.15
D	1.25	1.38	1.30
d	—	—	0.25
D2	0.30	0.50	0.40
E	0.95	1.075	1.00
e	—	—	0.35
E2	0.30	0.50	0.40
f	—	—	0.10
L	0.20	0.30	0.25
Z	—	—	0.05
All Dimensions in mm			

Suggested Pad Layout

Please see AP02001 at <http://www.diodes.com/datasheets/ap02001.pdf> for the latest version.

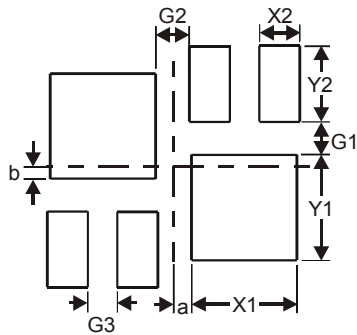

Dimensions	Value (in mm)
G1	0.16
G2	0.17
G3	0.15
X1	0.52
X2	0.20
Y1	0.52
Y2	0.375
a	0.09
b	0.06

IMPORTANT NOTICE

DIODES INCORPORATED MAKES NO WARRANTY OF ANY KIND, EXPRESS OR IMPLIED, WITH REGARDS TO THIS DOCUMENT, INCLUDING, BUT NOT LIMITED TO, THE IMPLIED WARRANTIES OF MERCHANTABILITY AND FITNESS FOR A PARTICULAR PURPOSE (AND THEIR EQUIVALENTS UNDER THE LAWS OF ANY JURISDICTION).

Diodes Incorporated and its subsidiaries reserve the right to make modifications, enhancements, improvements, corrections or other changes without further notice to this document and any product described herein. Diodes Incorporated does not assume any liability arising out of the application or use of this document or any product described herein; neither does Diodes Incorporated convey any license under its patent or trademark rights, nor the rights of others. Any Customer or user of this document or products described herein in such applications shall assume all risks of such use and will agree to hold Diodes Incorporated and all the companies whose products are represented on Diodes Incorporated website, harmless against all damages.

Diodes Incorporated does not warrant or accept any liability whatsoever in respect of any products purchased through unauthorized sales channel. Should Customers purchase or use Diodes Incorporated products for any unintended or unauthorized application, Customers shall indemnify and hold Diodes Incorporated and its representatives harmless against all claims, damages, expenses, and attorney fees arising out of, directly or indirectly, any claim of personal injury or death associated with such unintended or unauthorized application.

Products described herein may be covered by one or more United States, international or foreign patents pending. Product names and markings noted herein may also be covered by one or more United States, international or foreign trademarks.

LIFE SUPPORT

Diodes Incorporated products are specifically not authorized for use as critical components in life support devices or systems without the express written approval of the Chief Executive Officer of Diodes Incorporated. As used herein:

A. Life support devices or systems are devices or systems which:

1. are intended to implant into the body, or
2. support or sustain life and whose failure to perform when properly used in accordance with instructions for use provided in the labeling can be reasonably expected to result in significant injury to the user.

B. A critical component is any component in a life support device or system whose failure to perform can be reasonably expected to cause the failure of the life support device or to affect its safety or effectiveness.

Customers represent that they have all necessary expertise in the safety and regulatory ramifications of their life support devices or systems, and acknowledge and agree that they are solely responsible for all legal, regulatory and safety-related requirements concerning their products and any use of Diodes Incorporated products in such safety-critical, life support devices or systems, notwithstanding any devices- or systems-related information or support that may be provided by Diodes Incorporated. Further, Customers must fully indemnify Diodes Incorporated and its representatives against any damages arising out of the use of Diodes Incorporated products in such safety-critical, life support devices or systems.

Copyright © 2013, Diodes Incorporated

www.diodes.com

Mouser Electronics

Authorized Distributor

Click to View Pricing, Inventory, Delivery & Lifecycle Information:

[Diodes Incorporated:](#)

[BC847CW-7-F](#) [BC847CDLP-7](#)