

OLS10-BP112311

OLS

LINE GUIDANCE AND GRID LOCALIZATION

SICK
Sensor Intelligence.



Ordering information

Type	Part no.
OLS10-BP112311	1092169

Other models and accessories → www.sick.com/OLS



Detailed technical data

Features

Dimensions (W x H x D)	46 mm x 77 mm x 46 mm
Sensing distance	100 mm
Sensing distance tolerance	± 10 mm
Housing design (light emission)	Rectangular
Light source	LED, blue ¹⁾
Wave length	450 nm
Light spot size	180 mm x 11 mm ²⁾
Bar code types	Interleaved 2 of 5
Module width (min.)	≥ 1.5 mm
Line radius (min.)	≥ 0.5 m

¹⁾ Average service life: 100,000 h at T_J = +25 °C.

²⁾ Field of view line +90mm, field of view code +50mm.

Mechanics/electronics

Supply voltage	12 V DC ... 30 V DC ¹⁾
Ripple	≤ 5 V _{pp} ²⁾
Power consumption	< 6 W ³⁾
Sampling rate	10 ms ⁴⁾ 20 ms ⁵⁾
Accuracy optical center	± 1 mm
Switching output	PNP

¹⁾ Limit values when operated in short-circuit protected network: max. 8 A.

²⁾ May not exceed or fall below U_v tolerances.

³⁾ Without load.

⁴⁾ CANopen.

⁵⁾ Ethernet.

⁶⁾ Detailed description of the status output in operating manual.

⁷⁾ Sum I_{out} = Q1 + Q2.

Switching output (voltage)	PNP: HIGH = $V_S - \leq 2 \text{ V}$ / LOW < 0,5 V
Status output	PNP: HIGH = $V_S - \leq 2 \text{ V}$ / LOW < 0,5 V ⁶⁾
Output current I_{max}	< 100 mA ⁷⁾
Initialization time	< 10 s
Connection type	Connector M12, 12-pin
Protection class	III
Circuit protection	U_V connections, reverse polarity protected Output Q short-circuit protected Interference pulse suppression
Enclosure rating	IP64
LED risk group	1 (IEC 62471)
Weight	325 g
Housing material	Metal, metal

1) Limit values when operated in short-circuit protected network: max. 8 A.

2) May not exceed or fall below U_V tolerances.

3) Without load.

4) CANopen.

5) Ethernet.

6) Detailed description of the status output in operating manual.

7) Sum $I_{\text{out}} = Q1 + Q2$.

Communication interface

Ethernet	✓, TCP/IP
Cycle time	1 ms
Process data length	21 Byte Process Data In
CANopen	✓
Digital output	Q ₁ , Q ₂
Number	2

Ambient data

Ambient operating temperature	-10 °C ... +55 °C
Ambient temperature, storage	-20 °C ... +75 °C
Ambient light immunity	50,000 lx
Shock load	According to IEC 60068
UL File No.	NRKH.E181493 & NRKH7.E181493

Classifications

ECl@ss 5.0	27270906
ECl@ss 5.1.4	27270906
ECl@ss 6.0	27270906
ECl@ss 6.2	27270906
ECl@ss 7.0	27270906
ECl@ss 8.0	27270906
ECl@ss 8.1	27270906
ECl@ss 9.0	27270906
ECl@ss 10.0	27270906

ECl@ss 11.0	27270906
ETIM 5.0	EC001820
ETIM 6.0	EC001820
ETIM 7.0	EC001820
UNSPSC 16.0901	39121528

Dimensional drawing (Dimensions in mm (inch))

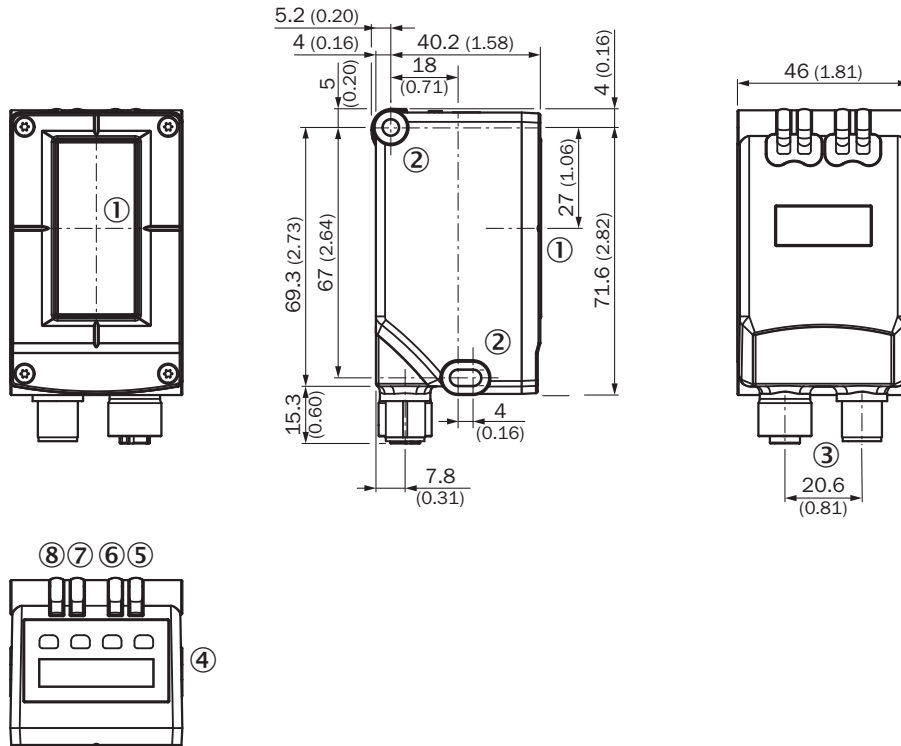

- ① Center of optical axis
- ② Mounting hole, \varnothing 4.2 mm
- ③ Connector M12, 12-pin/Connector M12, 4-pin, rotatable up to 90° (Ethernet)
- ④ Display and function buttons
- ⑤ Function signal indicator (green) "on"
- ⑥ Function signal indicator (yellow) "Q"
- ⑦ Function signal indicator (green) "Link"
- ⑧ Function signal indicator (yellow) "Act"

Connection diagram

Cd-395

M12 (A-coded)

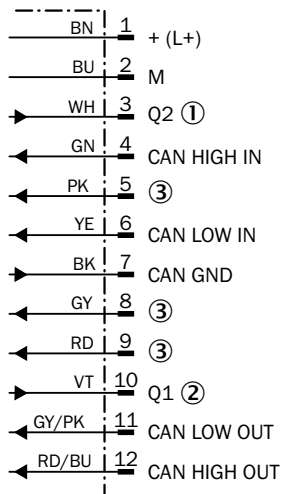
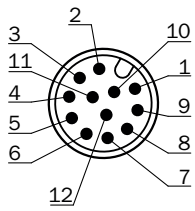





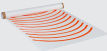
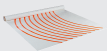

- ① Valid BarCode read
- ② Line detected
- ③ Reserved, do not connect

Recommended accessories

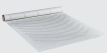
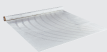
Other models and accessories → www.sick.com/OLS

	Brief description	Type	Part no.
Universal bar clamp systems			
	Plate N04 for universal clamp, steel, Zinc plated steel (sheet), Zinc die cast (clamping bracket), Universal clamp (5322626), mounting hardware	BEF-KHS-N04	2051610
	Mounting bar, straight, 200 mm, steel, steel, zinc coated, without mounting hardware	BEF-MS12G-A	4056054
	Mounting bar, L-shaped, 250 x 250 mm, steel, steel, zinc coated, without mounting hardware	BEF-MS12L-B	4056053
Codes			
	Luminescent duct tape for easy application to all types of flooring, width 2.5 cm, length 25 m, neon orange	ADHESIVE TAPE, FABRIC	5337868

	Brief description	Type	Part no.
	Luminescent rugged PVC adhesive tape for easy application to all types of flooring, width 2 cm, length 25 m, neon orange	ADHESIVE TAPE, PVC	5338378
	Luminescent rugged PVC adhesive tape, prepared as 90° arc with a radius of 500 mm, neon orange	ADHESIVE TAPE, PVC ARC	5338387
	Scope of delivery: 1 x 90° arc, luminescent rugged PVC adhesive tape, prepared as 90° arc with a radius of 1,000 mm, neon orange	ADHESIVE TAPE, PVC ARC	5338388
	Protective film for adhesive tape, slip resistance class R10, protection against abrasion and moisture, width 3,5 cm, length 50 m	PROTECTIVE FILM	5338386
	Protective film for adhesive tape, slip resistance class R10, protection against abrasion and moisture, prepared as 90° arc with a radius of 500 mm	PROTECTIVE FILM, ARC	5338389
	Protective film for adhesive tape, slip resistance class R10, protection against abrasion and moisture, prepared as 90° arc with a radius of 1,000 mm	PROTECTIVE FILM, ARC	5338390
	1D bar codes in 2/5 interleaved Format, set of 108 bar codes on 9 A4 Sheets, luminescent PVC backing material with protective film	SHEET, BAR CODE	5338408
Plug connectors and cables			
	Head A: female connector, M12, 12-pin, straight Head B: Flying leads Cable: Sensor/actuator cable, PVC, shielded, 5 m	DOL1212-G05MAS02	6042754
	Head A: male connector, M12, 4-pin, straight, D-coded Head B: male connector, RJ45, 4-pin, straight Cable: Ethernet, PROFINET, PUR, halogen-free, shielded, 5 m	YM2D24-050PN1MRJA4	2106184

SICK AT A GLANCE

SICK is one of the leading manufacturers of intelligent sensors and sensor solutions for industrial applications. A unique range of products and services creates the perfect basis for controlling processes securely and efficiently, protecting individuals from accidents and preventing damage to the environment.

We have extensive experience in a wide range of industries and understand their processes and requirements. With intelligent sensors, we can deliver exactly what our customers need. In application centers in Europe, Asia and North America, system solutions are tested and optimized in accordance with customer specifications. All this makes us a reliable supplier and development partner.

Comprehensive services complete our offering: SICK LifeTime Services provide support throughout the machine life cycle and ensure safety and productivity.

For us, that is “Sensor Intelligence.”

WORLDWIDE PRESENCE:

Contacts and other locations –www.sick.com