

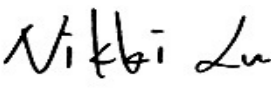

PSE Technology Corporation

SPECIFICATION FOR APPROVAL

| | |
|-------------------|--|
| CUSTOMER | _____ |
| NOMINAL FREQUENCY | 25.000000 MHz |
| PRODUCT TYPE | TYPE FL 3.2x2.5 SEAM SEALED CRYSTAL |
| PART NUMBER | FL2500283Z |
| CUSTOMER P/N | _____ |
| ISSUE DATE | September 10, 2014 |
| VERSION | B |

| APPROVED | PREPARED | QA |
|---|---|---|
|  |  |  |
| APPROVED BY CUSTOMER | | |
| Please return one copy with approval to PSE-TW | | |

PSE Technology Corporation

No.2, Tzu-Chiang 5th Rd., Chung Li Industrial Park,
 Chung Li City, Taoyuan County, Taiwan (R.O.C.)
 TEL:886-3-451-8888
 FAX:886-3-461-3865
<http://www.saronix-ecera.com.tw/>

- *Pb-free
- *RoHS Compliant
- *HF-Halogen Free
- *REACH Compliant

A Company of PERICOM Semiconductor Corporation

TYPE FL 3.2x2.5 SEAM SEALED CRYSTAL

FL2500283Z

VER.B 10-SEP-14

VERSION HISTORY

| Version No. | Version Date | Customer Receipt Date | Supplier Receipt Date | Description | Notes |
|-------------|---------------|-----------------------|-----------------------|--------------------------------------|-------|
| A | Sep. 4, 2014 | | | Initial Release | |
| B | Sep. 10, 2014 | | | Updated Drive level & added C1 spec. | |

TYPE FL 3.2x2.5 SEAM SEALED CRYSTAL

FL2500283Z

VER.B 10-SEP-14

ELECTRICAL SPECIFICATIONS

| Item | Symbol | Specifications | Units | Notes |
|------------------------------|--------|--------------------|-------|------------------------------------|
| Nominal Frequency | Fn | 25.000000 | MHz | |
| Mode of Oscillation | MO | AT Cut-Fundamental | | |
| Load Capacitance | CL | 20 | pF | |
| Calibration Tolerance | FL | ± 30 | ppm | at 25°C±3°C |
| Operating Temperature Range | TR | -20 to +70 | °C | |
| Frequency Stability | F/T | ± 30 | ppm | Reference to the Frequency at 25°C |
| Drive Level | | 0.01 / 100 / 500 | μW | Min. / Typ. / Max. |
| Equivalent Series Resistance | ESR | 50 | Ω | Max. |
| Shunt Capacitance | C0 | 5 | pF | Max. |
| Motional Capacitance | C1 | 3.1 | fF | Typ. |
| Aging at 25°C | | ± 3 | ppm | Max, 1st year |
| Storage Temperature | | -55 to +125 | °C | |
| Insulation Resistance | | 500 | MΩ | Min |

** This product doesn't include harmful substance that stipulated by SONY SS-00259 Level 1 and S-AT2-001 Level 1 standard. RoHS Compliant (Pb - Free).

TYPE FL 3.2x2.5 SEAM SEALED CRYSTAL

FL2500283Z

VER.B 10-SEP-14

RELIABILITY SPECIFICATIONS

MECHANICAL AND ENVIRONMENTAL RATINGS:

- a) FINE LEAK TEST: JESD22-A109 (Condition 1A)
- b) GROSS LEAK TEST: JESD22-A109 (Condition C)
- c) MOISTURE RESISTANCE: JESD22-A113
- d) SHOCK: JESD22-B104 (Condition B)
- e) SOLDERABILITY : (RoHS version): J-STD-002
- f) VIBRATION: JESD22-B103
- g) SOLVENT RESISTANCE: JESD22-B107
- h) RESISTANCE TO SOLDERING HEAT (RoHS version): J-STD-020D Table 5.2 Pb free devices (3 cycles max)

SUGGESTED IR REFLOW PROFILE

*As per IPC-JEDEC J-STD-020D

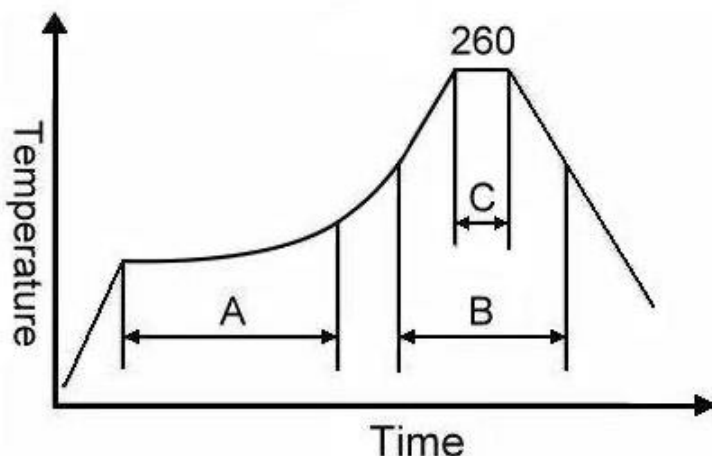

Note:

| | Stage | Temperature | Time |
|---|--------------|-------------|------------|
| A | Preheat | 150~200°C | 60~120 Sec |
| B | Primary Heat | 217°C | 60~150 Sec |
| C | Peak | 260°C | 10 Sec |

For soldering reflow profile and reliability test ratings go to: <http://www.pericom.com/pdf/sre/reflow.pdf>

TYPE FL 3.2x2.5 SEAM SEALED CRYSTAL

FL2500283Z

VER.B 10-SEP-14

MARKING



MECHANICAL DRAWINGS (Scale: None. Dimensions are in mm.)

Recommended Land Pattern

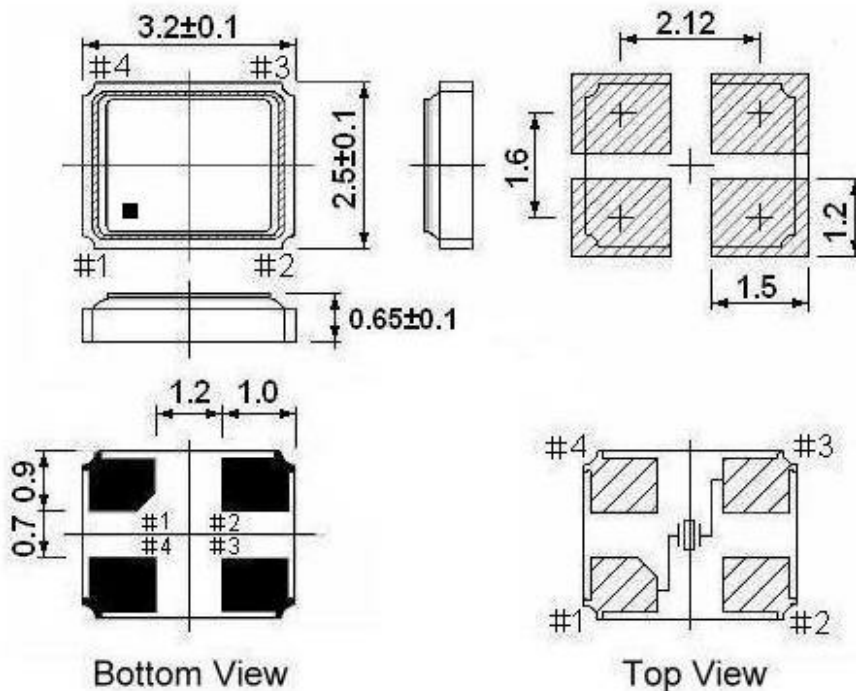

** Recommended - Pin 1 & 3 : CRYSTAL
Pin 2 & 4 : GND

Notes:

1. Package drawings are for reference only, and the appearances of objects may vary. Actual packages are based on the real product.
2. The marking dot denotes Pin#1.
3. The position and shape of the chamfer pin may vary and are based on the real product.

TYPE FL 3.2x2.5 SEAM SEALED CRYSTAL

FL2500283Z

VER.B 10-SEP-14

Tape & Reel

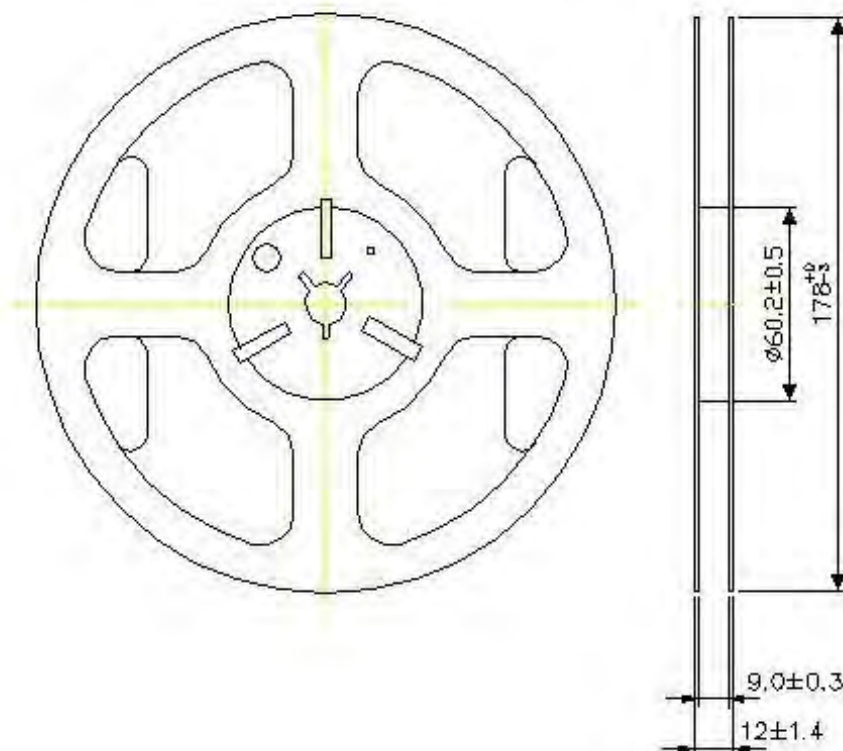
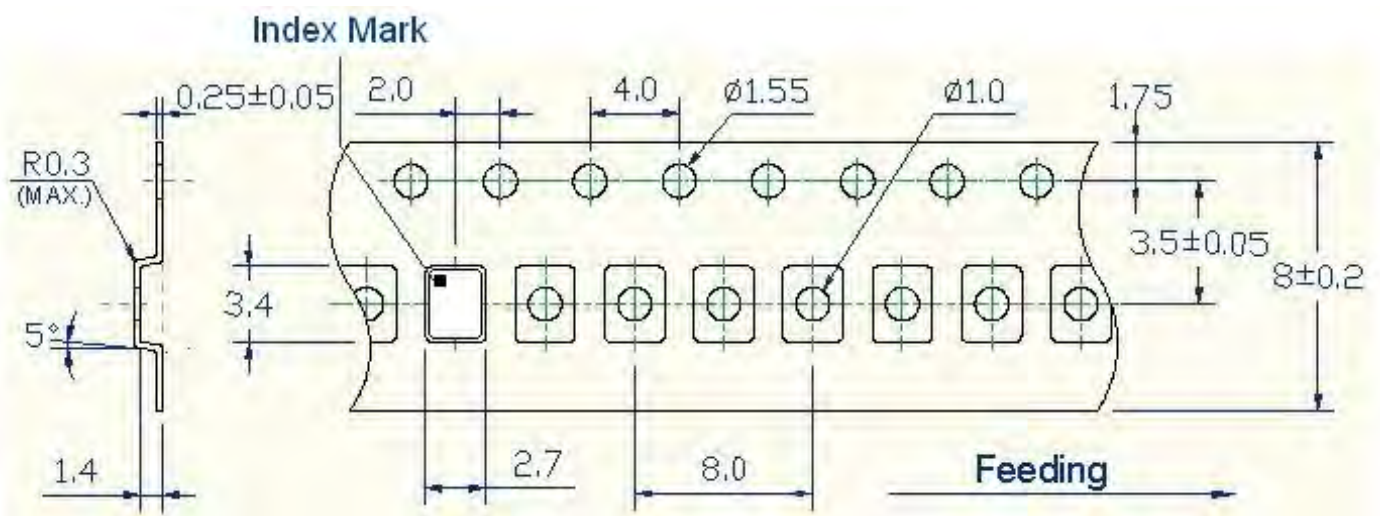

1. 230mm minimum leader which consist of carrier and/or tape followed by a minimum of 160mm of empty carrier tape sealed with cover tape.
2. 160mm minimum trailer of empty carrier tape sealed with cover tape.

TYPE FL 3.2x2.5 SEAM SEALED CRYSTAL

FL2500283Z

VER.B 10-SEP-14

PACKING



Mouser Electronics

Authorized Distributor

Click to View Pricing, Inventory, Delivery & Lifecycle Information:

[Diodes Incorporated:](#)

[FL2500283Z](#)