

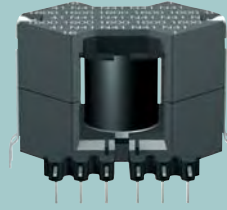

Product Profile 2008

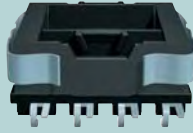
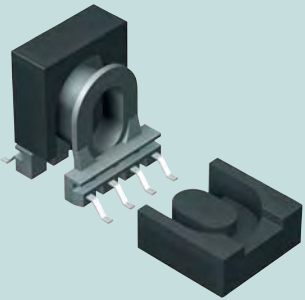

Ferrites and Accessories

Ferrite und Zubehör

Welcome to the World of Electronic Components and Modules



EPCOS is a leading manufacturer of electronic components and modules and provides one-stop shopping for a comprehensive range of products. Our portfolio includes capacitors and inductors, ceramic components, arresters, and surface and bulk acoustic wave components. EPCOS focuses on fast-growing and technologically demanding markets in the areas of information and communications technology, automotive, industrial, and consumer electronics. We offer our customers both standard components as well as application-specific solutions.

EPCOS has design, manufacturing and marketing facilities in Europe, Asia and the Americas. With our global presence we are able to provide our customers with local development know-how and support in the early phases of their projects.

EPCOS is continually improving its processes and thus the quality of its products and services. The Group is ISO/TS 16949 certified.

EPCOS ist ein führender Hersteller elektronischer Bauelemente und Module und bietet ein breit gefächertes Produktangebot aus einer Hand. Unser Portfolio umfasst Kondensatoren und Induktivitäten, keramische Bauelemente, Ableiter sowie Surface- und Bulk-Acoustic-Wave-Komponenten. EPCOS konzentriert sich auf schnell wachsende und technologisch anspruchsvolle Märkte im Bereich der Informations- und Kommunikationstechnik sowie der Automobil-, Industrie- und Konsum-Elektronik. Wir bieten unseren Kunden sowohl Standardprodukte als auch anwendungsspezifische Lösungen.

EPCOS verfügt über Entwicklungs-, Produktions- und Vertriebsstätten in Europa, Asien sowie in Nord- und Südamerika. Durch unsere globale Präsenz können wir Kunden bereits in der Frühphase ihrer Projekte mit Entwicklungskompetenz vor Ort unterstützen.

EPCOS verbessert kontinuierlich seine Prozesse und damit die Qualität seiner Produkte und Dienstleistungen. Der Konzern ist nach ISO/TS 16949 zertifiziert.

Ferrites and Accessories

Ferrite und Zubehör

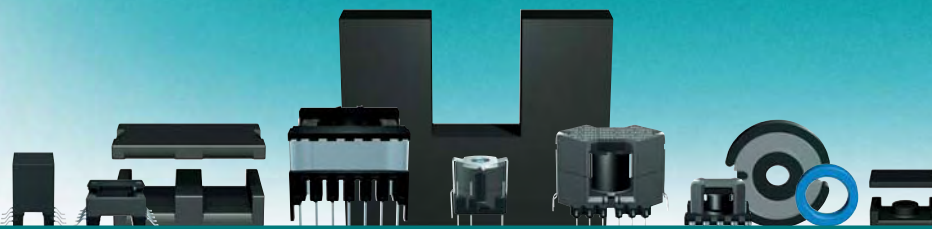

Contents / Inhalt

Preview	Vorwort	4
Materials	Werkstoffe	6
Products for telecommunications and data processing	Produkte für Telekommunikation und Datenverarbeitung	
■ RM cores	■ RM-Kerne	8
■ Low-profile RM cores	■ Low-Profile RM-Kerne	10
■ P cores	■ P-Kerne	14
■ EP cores	■ EP-Kerne	18
■ EPX/EPO cores	■ EPX-/EPO-Kerne	20
Products for industrial applications	Produkte für Industrie-Anwendungen	
■ P core halves	■ Einzelschalen	22
■ PM cores	■ PM-Kerne	24
■ U/I cores	■ U-/I-Kerne	26
Products for power supplies and lighting technology	Produkte für Stromversorgungen und Leuchtentechnik	
■ E cores	■ E-Kerne	28
■ ELP/I cores	■ ELP-/I-Kerne	34
■ EQ/I planar cores	■ EQ-/I-Planarkerne	36
■ ER/I planar cores	■ ER-/I-Planarkerne	38
■ ER cores	■ ER-Kerne	40
■ PQ cores	■ PQ-Kerne	42
■ ETD cores	■ ETD-Kerne	44
■ EFD/EV cores	■ EFD-/EV-Kerne	46
Products for EMI suppression applications	Produkte für Störschutz-Anwendungen	
■ Toroids	■ Ringkerne	48
■ Symbols and terms	■ Symbole und Begriffe	52
■ Cautions and warnings	■ Warn- und Sicherheitshinweise	53
■ Important notes	■ Wichtige Hinweise	54
■ Addresses	■ Adressen	55

Ferrites and Accessories

Ferrite und Zubehör



Preview / Vorwort

Ferrites are indispensable key components in many modern, high-performance technologies. They are constantly penetrating new applications, for example, in entertainment and industrial electronics, in lighting, and in information and communication technology. EPCOS ranks among the world's leading suppliers of ferrites and accessories.

In materials for broadband and power engineering we are setting new standards. With an extensive range of ferrite cores plus matching accessories, we are able to offer an optimum solution for nearly every possible application.

Customers all over the world are already profiting from this capability. They all count on our competence and innovation, trust in our quality and logistics. Our experts will be glad to support you. Make our creativity and competence count for your success too.

Ferrite sind unverzichtbare Schlüsselkomponenten in vielen modernen Hochleistungstechnologien. Sie finden immer neue Anwendungen beispielsweise in der Unterhaltungs- und Industrieelektronik, in der Beleuchtungstechnik sowie in der Informations- und Kommunikationstechnik. EPCOS gehört zu den weltweit führenden Anbietern von Ferriten und Zubehör.

Bei hochpermeablen und Leistungsmaterialien setzen wir neue Maßstäbe. Mit einem umfangreichen Typenspektrum von Ferritkernen und dem dazu passenden Zubehör bieten wir optimale Lösungen, die nahezu jeden Lieferwunsch erfüllen. Davon profitieren Kunden in aller Welt. Sie alle setzen auf unsere Kompetenz und Innovationskraft, vertrauen unserer Qualität und Logistik. Unsere Experten stehen Ihnen gerne zur Verfügung. Nutzen auch Sie unsere Kreativität und Kompetenz für Ihren Erfolg.



Our research and development activities constantly keep pace with the demands of the market, orienting fully on customer needs.

Unsere Forschungs- und Entwicklungstätigkeiten messen wir konsequent an den Anforderungen des Marktes und richten sie auf die Wünsche unserer Kunden aus.

Miniaturization of power modules Miniaturisierung bei Leistungsmodulen	Reduction of core losses, development of flat and small cores Reduzierung der Kernverlustleistung, Entwicklung flacher und kleiner Kerne
DC biasing Gleichstrom-vormagnetisierung	Development and improvement of materials with high saturation Verbesserung und Neuentwicklung von Materialien mit hoher Sättigung
Access applications Access-Anwendungen	New materials for broadband transformers, development of optimized core forms Neue Werkstoffe für Breitbandübertrager, Entwicklung optimierter Kernformen
Interference suppression Störschutzanwendungen	New materials in expanded core spectrum Neue Werkstoffe bei erweitertem Kernspektrum
Environmentally compatible products Umweltverträgliche Produkte	Development of lead-free surfaces in accessories, halogen-free plastics, optimization of packaging Entwicklung bleifreier Oberflächen beim Zubehör, halogenfreie Kunststoffe, Verpackungsoptimierung
Customer support Kundenunterstützung	High application understanding, Magnetic design tool, Time to market Hohes Applikationsverständnis, Magnetic Design Tool, Time to Market

Please read *Cautions and warnings* on page 53 and *Important notes* on page 54.
Bitte beachten Sie die Seite 53 *Warn- und Sicherheitshinweise* sowie *Wichtige Hinweise* auf Seite 54.

Materials Werkstoffe

The starting materials for ferrites are iron, manganese, zinc and nickel oxides. From these raw materials EPCOS laboratories, working with the latest microengineering techniques, constantly produce new ferrite materials with their own specific properties.

Cooperating closely with customers, we continuously match our product spectrum to what the market demands. And in doing this, the properties of ferrite materials are sounded to their physical boundaries.

The following tables give an overview of the major magnetic properties of EPCOS ferrite materials.

Die Ausgangsmaterialien für Ferrite sind Eisen-, Mangan-, Zink- und Nickeloxide. Aus diesen Grundstoffen entstehen in den Labors von EPCOS mit modernsten Microengineering-Techniken immer neue Ferritmaterialien mit jeweils besonderen Eigenschaften.

In enger Zusammenarbeit mit unseren Kunden passen wir unser Produktspektrum ständig an die Erfordernisse des Marktes an. Dabei werden die Eigenschaften der Ferritwerkstoffe bis an die physikalischen Grenzen ausgelotet.

Die folgenden Tabellen geben einen Überblick über die wichtigsten magnetischen Eigenschaften der EPCOS-Ferritwerkstoffe.



Main application: Power transformers and chokes Anwendungsschwerpunkt: Leistungsübertrager und Drosseln

Performance factor		μ_i	f	$P_V^{1)}$	$B_S^{2)}$	Features	Main applications	Core shapes	
low \longrightarrow high			kHz	kW/m ³	mT	Merkmale	Hauptanwendungen	Kernformen	
	N72		2500	25 ... 300	540	370	Flat power loss vs. temperature Flacher Temperaturverlauf	Ballasts for energy-saving lamps EVG für Energiesparlampen	E, EFD
		N92	1500	25 ... 500	410	440	High flux density, large ΔB swing, low losses (25 ... 300 kHz) Hohe Flussdichte, großer Induktionshub ΔB , kleine Verluste (25 ... 300 kHz)	Diode splitting transformers, high-voltage transformers, chokes Diodenplitting-/Hochspannungsübertrager, Drosseln	RM, ETD, EFD, ER, E, ELP, EQ Toroids / Ring
N41			2800	25 ... 150	1400	390	High permeability, low losses (25 ... 100 kHz) at low temperatures Hohe Permeabilität, kleine Verluste (25 ... 100 kHz) bei niedrigen Temperaturen	Pulse transformers, inverters for CCFL ⁴⁾ Impulsübertrager, Inverter für CCFL ⁴⁾	RM, P
N27			2000	25 ... 150	920	410	Low losses (25 ... 500 kHz), excellent DC bias behavior	Power transformers and chokes for medium- to high-frequency SMPS	ELP, RM, EFD, EP, EQ, P, PM, ETD, ER, E, U Toroids / Ring
		N51	3000	25 ... 150	700	380	Kleine Verluste (25 ... 500 kHz), exzellentes DC-Bias-Verhalten	Leistungsübertrager und Drosseln für SNT (MF bis HF)	
		N87	2200	25 ... 500	375	390			
		N97	2300	25 ... 500	300	410			
		N95	3000	25 ... 500	350	410	High temperature stability Hohe Temperaturstabilität	Power transformers Leistungsübertrager	E, ER, ETD
		N49	1500	300 ... 1000	80 ³⁾	400	Low losses (0.5 ... 1 MHz) Kleine Verluste (0.5 ... 1 MHz)	High-frequency power transformers and chokes HF-Leistungsübertrager und Drosseln	RM, EFD, ER, ELP, EQ Toroids / Ring

1) f = 100 kHz, \hat{B} = 200 mT, T = 100 °C, 2) \hat{H} = 1200 A/m, f = 10 kHz, T = 100 °C, 3) f = 500 kHz, \hat{B} = 50 mT, T = 100 °C, 4) Cold cathod fluorescence lamp

Materials Werkstoffe

Main application: Resonant circuit inductors and filters Anwendungsschwerpunkt: Spulen für Resonanzkreise und Filter									
tanδ/μ _i level low → high		μ _i	f _{max} MHz	T _c °C	B _s mT	η _B 10 ⁻⁶ /mT	Features Merkmale	Main applications Hauptanwendungen	Core shapes Kernformen
	K1	80	12	> 400	310 ¹⁾	< 36	Low loss factor for high-Q filters Kleiner Verlustfaktor für Filter mit hoher Güte	VHF filters, Balun, CATV, RF transformers UHF Filter, Balun, CATV, HF-Übertrager	RM, P Toroids / Ring
	M33	750	1.0	> 200	400 ²⁾	< 1.8		RF transformers HF-Übertrager	RM, P
	N48	2300	0.1	> 170	420 ³⁾	< 0.4		RF transformers, filters for telecom HF-Übertrager, Filter für Telecom	RM, P
	N22	2300	0.2	> 145	370 ³⁾	< 1.4		Inductive proximity switches Näherungsschalter	PS
K10		800	1.0	> 150	320 ¹⁾	< 5.0	High impedance for EMC applications Hohe Impedanz für EMV-Anwendungen	Line attenuation, current-compensated chokes Leitungsdämpfung, stromkompensierte Drosseln	Toroids / Ring
K8		860	0.5	> 150	340 ³⁾	< 4.5			
K7		1500	0.5	> 110	280 ³⁾	< 4.0			
M13		2300	0.1	> 105	280 ³⁾	< 4.0			

1) Ĥ = 5000 A/m, f = 10 kHz, T = 25 °C 2) Ĥ = 2000 A/m, f = 10 kHz, T = 25 °C 3) Ĥ = 1200 A/m, f = 10 kHz, T = 25 °C

Main application: Broadband transformers and EMC applications Anwendungsschwerpunkt: Breitbandübertrager und EMV-Anwendungen									
Permeability level low → high		μ _i	f _{max} kHz	T _c °C	B _s @ 25 °C mT	η _B 10 ⁻⁶ /mT	Features Merkmale	Main applications Hauptanwendungen	Core shapes Kernformen
N45		3800	100	> 255	550	< 0.3	High saturation Hohe Sättigung	Filters for telecom Filter für Telecom	RM, EP, ER
T57		4000	500	> 140	430	< 0.3	L _{IDC} (0-70 °C)	LAN, DSL	RM, EP, Toroids / Ring
N30		4300	400	> 130	380	< 1.1		Current-comp. chokes Stromkomp. Drosseln	RM, P, EP, E, Toroids / Ring
T65		5200	200	> 160	460	< 1.1		RF chokes HF-Drosseln	ER, Toroids / Ring
T35		6000	200	> 130	390	< 1.1			RM, P, EP, Toroids / Ring
	T37	6500	300	> 130	380	< 1.1	High frequency bandwidth Große Frequenzbandbreite	Power line filters Netzfilter	P, Toroids / Ring
	T36	7000	100	> 130	400	< 1.1		Energy meters Stromzähler	Toroids / Ring
	T38	10000	100	> 130	430	< 0.3		DSL, impedance and matching transformers	RM, P, EP, ER, Toroids / Ring
	T66	13000	100	> 100	360	< 0.3		DSL, Impedanz- und Anpassungsübertrager	RM, P, EP, E
	T46	15000	100	> 130	400	< 2.0	Highest permeability Höchste Permeabilität	ISDN transformers ISDN-Übertrager	Toroids Ring

RM Cores

RM-Kerne

Technical data Technische Daten



Type Typ	Air gap Luft- spalt	Material (Code number / Kennziffer) AL values (nH); AL tolerance code / AL-Werte (nH); AL-Toleranzbuchstabe									
		K1 (01)	M33 (33)	N48 (48)	N45 (45)	N30 (30)	T35 (35)	T38 (38)	T66 (66)	N49 (49)	N41 (41)

Cores (Accessories on page 12-13) / Kerne (Zubehör siehe Seite 12-13)

RM 4	●	16, 25 A	40, 63 A	63, 100, 160 A																
	○				1700 R	1900 R	2800 Y	3700 Y				750 R								
RM 5	●	25, 40 A	63, 100 A	160, 250, 315 A																
	○			1800 R																
RM 6	●	40 A	63, 100 A	160, 250 A																
	●			315, 400 A																
	○			2200 R																
	○				3500 R	4300 R	6200 R	8600 Y	12300 Y	1700 R	3100 R									
RM 7	●			250, 315 A																
	○						5000 R		10000 Y		1900 R									
RM 8	●			630 J																
	●			250, 315, 400 A																
	●																			
	●																			
	○			2900 R																
RM 10	●			400, 630 A																
	●																			
	●																			
	○						5700 R		12500 Y		2200 R	4100 R								
RM 12	●																			
	●																			
	○						7600 R	16000 Y			2900 R	5500 R								
RM 14	●																			
	●																			
	○																			

● = gapped / mit Luftspalt
○ = ungapped / ohne Luftspalt

1) Cores with center hole (w/o threaded sleeve) also available.
Kerne mit Mittelloch (ohne Gewindehülse) ebenfalls lieferbar.

RM cores for optimized PCB real estate

RM cores are ideal for

- extremely low-loss, highly stable filter coils and other resonance-determining inductive components (K1, M33, N48) as well as
- low-distortion broadband transformers for small signals (N45, T38, T57, T66).

- RM cores without center hole are also used in power electronics. Typical materials employed here are N87, N92 and N97.

The sizes are specified by IEC 62317-4. The accessories are suitable for automatic processing. RM cores are supplied in sets.

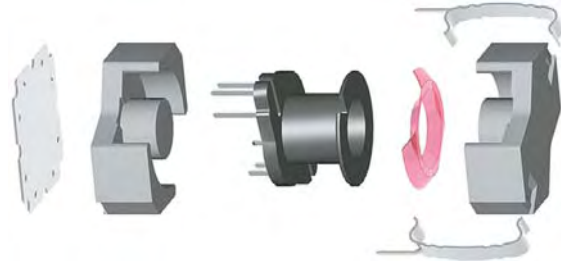
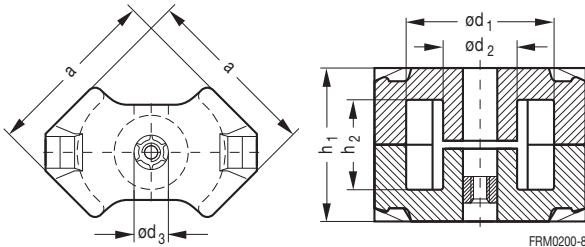

		Ordering code (per set) Bestellnummer (pro Satz)	
N87 (87)	N97 (97)		
			B65803N0***A0** ¹
1100 R	1100 R		B65803J0000+0**
			B65805N****A0** ¹
			B65805C0000R048
2000 R	2000 R		B65805J0000+0**
			B65807N0***A0** ¹
			B65807J0250A041
			B65807C0000R048
2400 R	2400 R		B65807J0000+0**
			B65819N0***A048 ¹
			B65819J0***J041
2700 R	2700 R		B65819J0000+0**
			B65811F0630J048 ¹
			B65811F0***A048 ¹
250, 400 A			B65811J0***A0**
			B65811J0***J041
			B65811J1600K041
			B65811D0000R048
3300 R	3300 R		B65811J0000+0**
			B65813N0***A048 ¹
			B65813J0250A041
			B65813J0630J041
			B65813J1600K041
4200 R	4200 R		B65813J0000+0**
			B65815E0***A041
			B65815E****J041
5300 R	5300 R		B65815E0000R0**
			B65887E0***A041
			B65887E1000J041
6000 R	6000 R		B65887E0000R0**

*, +: See ordering code example
Siehe Bestellbeispiel

Magnetic characteristics (per set) / Magnetische Formkenngrößen (pro Satz)

Type	$\Sigma I/A$ mm ⁻¹	l_e mm	A_e mm ²	A_{min} mm ²	V_e mm ³
RM 4	1.9 (1.7)	21.0 (22.0)	11.0 (13.0)	– (11.3)	231 (286)
RM 5	1.0 (0.93)	20.8 (22.1)	20.8 (23.8)	– (18)	433 (526)
RM 6	0.86 (0.78)	26.9 (28.6)	31.3 (36.6)	– (31)	840 (1050)
RM 7	0.75 (0.70)	29.8 (30.4)	40 (43)	– (39)	1190 (1310)
RM 8	0.68 (0.59)	35.1 (38)	52 (64)	– (55)	1825 (2430)
RM 10	0.50 (0.45)	42 (44)	83 (98)	– (90)	3490 (4310)
RM 12	– (0.39)	– (57)	– (146)	– (125)	– (8320)
RM 14	– (0.35)	– (70)	– (200)	– (170)	– (14000)

Values in parantheses for core sets without center hole
Werte in Klammern für Kernsätze ohne Mittelloch

Main dimensions (mm) / Hauptmaße (mm)

Type	a	$\varnothing d_1$	$\varnothing d_2$	$\varnothing d_3$	h_1	h_2
RM 4	9.8 –0.4	8.0 +0.3	3.9 –0.2	2.0 +0.1	10.5 –0.2	7.0 +0.4
RM 5	12.3 –0.5	10.2 +0.4	4.9 –0.2	2.0 +0.1	10.5 –0.2	6.3 +0.4
RM 6	14.7 –0.6	12.4 +0.5	6.4 –0.2	3.0 +0.1	12.5 –0.2	8.0 +0.4
RM 7	17.2 –0.7	14.75 +0.65	7.25 –0.3	3.0 +0.1	13.5 –0.2	8.4 +0.5
RM 8	19.7 –0.8	17.0 +0.6	8.55 –0.3	4.4 +0.2	16.5 –0.2	10.8 +0.4
RM 10	24.7 –1.1	21.2 +0.9	10.9 –0.4	5.4 +0.2	18.7 –0.2	12.4 +0.6
RM 12	29.8 –1.2	25.0 +1.0	12.8 –0.4	–	24.6 –0.2	16.8 +0.6
RM 14	34.8 –1.3	29.0 +1.0	15.0 –0.5	–	30.2 –0.2	20.8 +0.6

Ordering code example / Bestellbeispiel

B65803N0160A048

Versions / Ausführungsarten

A, C, D

with center hole (without threaded sleeve)
mit Mittelloch (ohne Gewindehülse)

F, N

with center hole (with threaded sleeve)
mit Mittelloch (mit Gewindehülse)

E, J

without center hole / ohne Mittelloch

■ Type / Bauform

■ Version / Ausführungsart

■ A_L value in nH for cores with air gap (4 digits). For cores without air gap: 0000
 A_L -Wert in nH für Kerne mit Luftspalt (4 Ziffern). Für Kerne ohne Luftspalt: 0000

■ Code letter for A_L tolerance

Kennbuchstabe für A_L -Toleranz
A $\geq \pm 3\%$, J $\geq \pm 5\%$, K $\geq \pm 10\%$
R $\geq +30/-20\%$, Y $\geq +40/-30\%$

■ Code number for material

Kennziffern für Material

RM-Kerne für optimale Platznutzung auf Leiterplatten

RM-Kerne sind ideal für

- äußerst verlustarme, hochstabile Filterspulen und andere resonanzbestimmende Induktivitäten (K1, M33, N48) sowie

- klirrarmer Breitbandübertrager bei kleiner Signalaussteuerung (N45, T38, T57, T66).

- RM-Kerne ohne Mittelloch werden auch in der Leistungselektronik verwendet (N87, N92, N97).

Die Größen sind in IEC 62317-4 festgelegt. Das Zubehör ist für automatische Verarbeitung geeignet. RM-Kerne werden satzweise geliefert.

Low-Profile RM Cores

Low-Profile RM-Kerne

Technical data Technische Daten



Type Typ	Air gap Luft- spalt	Material A _L values (nH) / A _L -Werte (nH)			
		T38	N49	N87	N92
Cores (Accessories on page 12-13) / Kerne (Zubehör siehe Seite 12-13)					
RM 4 LP	○	5000 +40/-30%			
	○		950 +30/-20%		
	○			1300 +30/-20%	
	○				1000 +30/-20%
RM 5 LP	○	7700 +40/-30%			
	○		1700 +30/-20%		
	○			2400 +30/-20%	
	○				1900 +30/-20%
RM 6 LP	○	10500 +40/-30%			
	○		2200 +30/-20%		
	○			3000 +30/-20%	
	○				2300 +30/-20%
RM 7 LP	○	11500 +40/-30%			
	○		2400 +30/-20%		
	○			3300 +30/-20%	
	○				2600 +30/-20%
RM 8 LP	○		2900 +30/-20%		
	○			4100 +30/-20%	
	○				3100 +30/-20%
RM 10 LP	○		3700 +30/-20%		
	○			5200 +30/-20%	
	○				4000 +30/-20%
RM 12 LP	○		4500 +30/-20%		
	○			6300 +30/-20%	
	○				4800 +30/-20%
RM 14 LP	○		5100 +30/-20%		
	○			7100 +30/-20%	
	○				5400 +30/-20%

○ = ungapped / ohne Luftspalt

RM cores with substantially reduced total height

These cores can be used for small-signal, interface and matching transformers as well as for transformer and storage chokes in DC/DC converters with a high switching frequency.

The low-profile models are especially suitable for applications in which the winding is printed on the board and the cores are inserted from both sides.

Beside the standard material N87, further power materials such as N49, N97 and N92 are usable.

Low-profile cores are in accordance with IEC 62317-4.

They are supplied in sets.

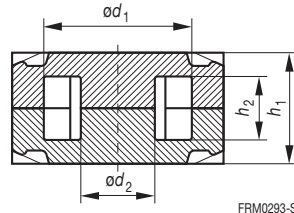
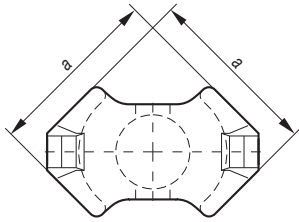
**Ordering code
(per set)**
**Bestellnummer
(pro Satz)**

B65803P0000Y038
B65803P0000R049
B65803P0000R087
B65803P0000R092
B65805P0000Y038
B65805P0000R049
B65805P0000R087
B65805P0000R092
B65807P0000Y038
B65807P0000R049
B65807P0000R087
B65807P0000R092
B65819P0000Y038
B65819P0000R049
B65819P0000R087
B65819P0000R092
B65811P0000R049
B65811P0000R087
B65811P0000R092
B65813P0000R049
B65813P0000R087
B65813P0000R092
B65815P0000R049
B65815P0000R087
B65815P0000R092
B65887P0000R049
B65887P0000R087
B65887P0000R092

Magnetic characteristics (per set) / Magnetische Formkenngrößen (pro Satz)

Type Typ	$\Sigma I/A$ mm ⁻¹	l_e mm	A_e mm ²	A_{min} mm ²	V_e mm ³
RM 4 LP	1.20	17.3	14.5	11.3	251
RM 5 LP	0.71	17.5	24.5	18.0	430
RM 6 LP	0.58	21.8	37.5	31.2	820
RM 7 LP	0.52	23.5	45.3	39.6	1060
RM 8 LP	0.44	28.7	64.9	55.4	1860
RM 10 LP	0.34	33.9	99.1	90.0	3360
RM 12 LP	0.29	42.0	147.5	124.7	6195
RM 14 LP	0.25	50.9	201.0	170.0	10230

Main dimensions (mm) / Hauptmaße (mm)

Type Typ	a	$\varnothing d_1$	$\varnothing d_2$	h_1	h_2
RM 4 LP	9.8 -0.4	8.0 +0.3	3.9 -0.2	7.8 -0.2	4.3 +0.4
RM 5 LP	12.3 -0.5	10.2 +0.4	4.9 -0.2	7.8 -0.2	3.6 +0.4
RM 6 LP	14.7 -0.6	12.4 +0.5	6.4 -0.2	9.0 -0.2	4.5 +0.4
RM 7 LP	17.2 -0.7	14.75 +0.65	7.25 -0.3	9.8 -0.2	4.7 +0.5
RM 8 LP	19.7 -0.8	17.0 +0.6	8.55 -0.3	11.6 -0.2	5.9 +0.4
RM 10 LP	24.7 -1.1	21.2 +0.9	10.9 -0.4	13.0 -0.2	6.7 +0.4
RM 12 LP	29.8 -1.2	24.9 +1.1	12.8 -0.4	16.8 -0.2	9.0 +0.5
RM 14 LP	34.8 -1.3	29.0 +1.0	15.0 -0.5	20.5 -0.2	11.1 +0.6

RM-Kerne mit deutlich verringerter Bauhöhe

Diese Kerne bieten sich an für Kleinsignal-, Schnittstellen- und Anpassungsübertrager sowie für Übertrager und Speicherdrosseln in DC/DC-Wandlern mit hoher Taktfrequenz.

Die Low-Profile-Formen eignen sich besonders für Leiterplatten, bei denen die Wicklung aufgedruckt ist und die Kerne von beiden Seiten durch die Platine gesteckt werden.

Für diese Anwendungen kommen auch die Leistungs-Materialien N49, N97 und N92 zum Einsatz.

Low-Profile-Kerne entsprechen IEC 62317-4.

Sie werden satzweise geliefert.

Accessories for RM Cores Zubehör für RM-Kerne

Technical data Technische Daten

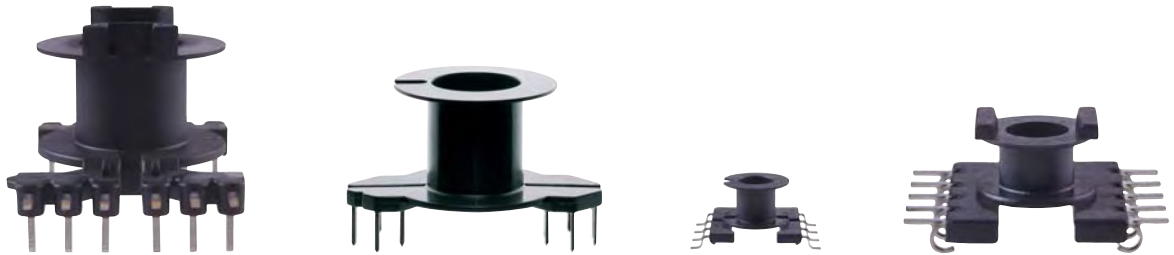

Type Typ	Coil formers Spulenkörper	Pins Stifte	Ordering code ¹⁾ Bestellnummer ¹⁾	Features ²⁾ Merkmale ²⁾
	Sections Kammern			
RM 4		1 5, 6	B65804K100*D001	PTH / Stifte
RM 4 LP	SMD	1 10	B65804B6010T001	J terminals
RM 5		1 4, 5, 6, 8	B65806K100*D001	PTH / Stifte
		2 6	B65806K1006D002	PTH / Stifte
	SMD	1 8	B65822F1008T001	Gullwing terminals
	SMD	2 8	B65822F1008T002	Gullwing terminals
	SMD	1 8	B65822J1008T001	J terminals
RM 6		1 4, 5, 6	B65808N100*D001	PTH / Stifte
		2 4, 6	B65808N100*D002	PTH / Stifte
		1 4, 5, 6	B65808K100*D001	PTH / Stifte
		1 8	B65808E1508T001	For power applications / Für Leistungsanwendungen
	SMD	2 8	B65808X1108D002	For SMPS transformers / Für SNT-Übertrager
RM 7		1 8	B65820W1008D001	Gullwing terminals
		2 8	B65820W1008D002	PTH / Stifte
		2 8	B65820W1008D002	PTH / Stifte
RM 8		1 5, 8, 12	B65812N10**D001	PTH / Stifte
		2 5	B65812N1005D002	PTH / Stifte
		1 5, 8, 12	B65812K10**D001	PTH / Stifte
		2 8	B65812K1008D002	PTH / Stifte
		1 12	B65812C1512T001	For power applications / Für Leistungsanwendungen
RM 10		2 8	B65812X1108D002	For SMPS transformers / Für SNT-Übertrager
		1 8, 12	B65814N10**D001	PTH / Stifte
		2 8	B65814N1008D002	PTH / Stifte
RM 12		1 12	B65814C1512T001	For power applications / Für Leistungsanwendungen
		1 11, 12	B65816N10**D001	PTH / Stifte
RM 14		1 12	B65816C1512T001	For power applications / Für Leistungsanwendungen
		1 10, 12	B65888N10**D001	PTH / Stifte
		1 12	B65888C1512T001	For power applications / Für Leistungsanwendungen

1) * Please insert number of pins
* Bitte Anzahl der Stifte einsetzen

2) Pin versions (PTH) on request
Stiftvarianten (PTH) auf Anfrage

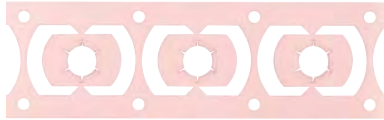

Type Typ	Clamps ³⁾ Klammern ³⁾	Insulating washer 1 Isolierscheibe 1	Insulating washer 2 Isolierscheibe 2
RM 4	B65806A2203X000	B65804A5000X000	B65804C2005X000
RM 4 LP	B65804P2204X000		
RM 5	B65806A2203X000	B65806A5000X000	B65806D2005X000
	B65806J2204X000		
RM 6	B65808A2203X000	B65808A5000X000	B65808C2005X000
	B65808J2204X000	B65808A5000X000	B65808C2005X000
RM 7	B65820B2001X000	B65820A5000X000	B65820C2005X000
RM 8	B65812A2203X000	B65812A5000X000	B65812C2005X000
RM 10	B65814A2203X000	B65814B5000X000	B65814B2005X000
RM 12	B65816A2002X000		
RM 14	B65888A2002X000		B65888B2005X000

³⁾ Ordering code per piece, 2 pieces required
Bestellnummer pro Stück, 2 Stück erforderlich

Adjusting screws on request
Abgleichschrauben auf Anfrage

Insulating washer 1 = between core and coil former
Insulating washer 2 = for double-clad PCBs

Isolierscheibe 1 = zwischen Kern und Spulenkörper
Isolierscheibe 2 = für doppelt kaschierte Leiterplatten

P Cores P 3.3 ... P 22

P-Kerne P 3.3 ... P 22

Technical data Technische Daten

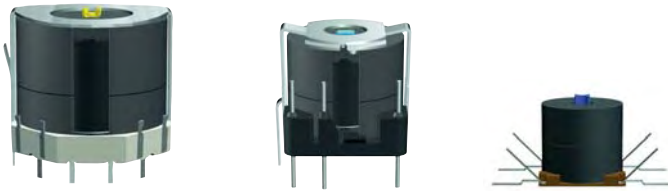

Type Typ	Air gap Luftspalt	Material (Code number / Kennziffer) AL values (nH); AL tolerance code / AL-Werte (nH); AL-Toleranzbuchstabe											
		K1 (01)	M33 (33)	N48 (48)	N30 (30)	T38 (38)	N41 (41)						
Cores (Accessories on page 17) / Kerne (Zubehör siehe Seite 17)													
P 3.3 x 2.6	○	25	Y			500	Y						
P 4.6 x 4.1	○			200	Y								
	○					800	Y						
P 5.8 x 3.3	○			350	R	800	Y						
P 7 x 4	●	25	A	63	A								
	●					100	A						
	○					1000	Y	2000	Y				
P 9 x 5	●	25, 40	A	63	A	100, 160, 200	A						
	●					250	J						
	○					1300	R	2500	R				
	○								5500	Y			
P 11 x 7	●	25, 40	A	40, 63	A	100, 160, 250	A						
	●					400	J						
	○			780	R	1800	R						
	○							3500	R	7000	Y		
P 14 x 8	●			100	A	160	A						
	●					250, 315, 400	A						
	○	140	R	970	R	2100	R						
	○							4600	R	9800	Y	3300	R
P 18 x 11	●	40	A	100	A	160, 250	A						
	●					315, 400, 500	A						
	●					630	J						
	○					2800	R						
	○							5900	R	12600	Y		
P 22 x 13	●					160, 250, 315	A						
	●					630	A						
	●					1250	J						
	○	220	R			3800	R						
	○							8300	R	16000	Y		

● = gapped / mit Luftspalt
○ = ungapped / ohne Luftspalt

1) Cores with threaded sleeve (version T) also available.
Kerne mit Gewindehülse (Version T) ebenfalls lieferbar.

2) Cores with threaded sleeve (version N) also available.
Kerne mit Gewindehülse (Version N) ebenfalls lieferbar.

Magnetically closed pot cores, very low leakage

These cores are suitable for

- resonant-circuit coils (filters) with high inductance stability and Q,
- low-distortion broadband small-signal transformers in materials T38 and N30.

■ P cores without center hole of N87 material are suitable for power applications. The larger, effective magnetic cross-section means that they feature higher AL, better flux density distribution and thus lower power loss.

P 9 x 5 through P 30 x 19 are acc. to IEC 60133, P 3.3 x 2.6 and P 5.8 x 3.3 to IEC 62323. They are supplied in sets.

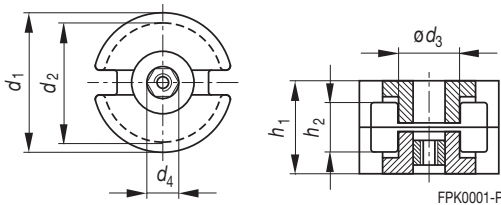

		Ordering code (per set) Bestellnummer (pro Satz)
N87 (87)		
		B65491C0000Y0**
		B65495B0000Y033
		B65495B0000Y030
		B65501D0000+0**
		B65511A00**A0**
		B65511A0100A048
		B65511A0000Y0**
		B65517D0***A0**1)
		B65517D0250J048
		B65517D0000R0**
		B65517W0000Y038
		B65531D0***A0**
		B65531D0400J048
		B65531D0000R0**
2000	R	B65531W0000+0**
		B65541D0***A0**1)
		B65541D0***A048 ¹⁾
2800	R	B65541D0000R0**
		B65541W0000+0**
		B65651D0***A0**1)
		B65651D0***A048 ¹⁾
		B65651D0630J048
		B65651D0000R048
3600	R	B65651W0000+0**
		B65661D0***A048 ²⁾
		B65661D0630A048 ²⁾
		B65661D1250J048
		B65661D0000R0**
4400	R	B65661W0000+0**

*, +: See ordering code example
Siehe Bestellbeispiel

Magnetic characteristics (per set) / Magnetische Formkenngrößen (pro Satz)

Type Typ	$\Sigma I/A$ mm ⁻¹	l_e mm	A_e mm ²	A_{min} mm ²	V_e mm ³
P 3.3 x 2.6	– (3.72)	– (5.1)	– (1.37)	–	– (7.0)
P 4.6 x 4.1	2.70	7.6	2.8	–	21.3
P 5.8 x 3.3	1.68	7.9	4.7	–	37
P 7 x 4	1.43	10.0	7.0	–	70
P 9 x 5	1.25 (1.13)	12.5 (13.4)	10.0 (11.9)	– (9.3)	125 (159)
P 11 x 7	1.00 (0.92)	15.9 (16.3)	15.9 (17.7)	– (14.1)	253 (289)
P 14 x 8	0.80 (0.73)	20.0 (21.0)	25.0 (28.7)	20.0 (23.6)	500 (603)
P 18 x 11	0.60 (0.57)	25.9 (26.6)	43.0 (46.7)	– (33.9)	1114 (1242)
P 22 x 13	0.50 (0.46)	31.6 (33.2)	63.0 (72.6)	– (58.1)	1990 (2410)

Values in parantheses for core sets without center hole / Werte in Klammern für Kernsätze ohne Mittelloch

Main dimensions (mm) / Hauptmaße (mm)

Type Typ	$\varnothing d_1$	$\varnothing d_2$	$\varnothing d_3$	$\varnothing d_4$	h_1	h_2
P 3.3 x 2.6	3.35 –0.17	2.45 +0.15	1.2 –0.1	–	2.6 –0.1	1.7 +0.2
P 4.6 x 4.1	4.65 –0.19	3.7 +0.15	2.2 –0.1	1.4 +0.05	4.1 –0.1	2.7 +0.2
P 5.8 x 3.3	5.80 –0.25	4.5 +0.2	2.5 –0.15	0.95 +0.1	3.4 –0.3	2.2 +0.2
P 7 x 4	7.35 –0.25	5.8 +0.2	3.0 –0.1	1.4 +0.05	4.2 –0.1	2.8 +0.2
P 9 x 5	9.30 –0.3	7.5 +0.25	3.9 –0.2	2.0 +0.1	5.4 –0.2	3.6 +0.3
P 11 x 7	11.3 –0.4	9.0 +0.4	4.7 –0.2	2.0 +0.1	6.6 –0.2	4.4 +0.3
P 14 x 8	14.3 –0.5	11.6 +0.4	6.0 –0.2	3.0 +0.1	8.5 –0.3	5.6 +0.4
P 18 x 11	18.4 –0.8	14.9 +0.5	7.6 –0.3	3.0 +0.1	10.6 –0.2	7.2 +0.4
P 22 x 13	22.0 –0.8	17.9 +0.6	9.4 –0.3	4.4 +0.2	13.6 –0.4	9.2 +0.4

Ordering code example / Bestellbeispiel

B65541D0040A048

Versions / Ausführungsarten

A, B, D: with center hole (w/o threaded sleeve)
mit Mittelloch (ohne Gewindehülse)

N, T: with center hole (with threaded sleeve)
mit Mittelloch (mit Gewindehülse)

C, W: without center hole / ohne Mittelloch

■ Type / Bauform

■ Version / Ausführungsart

■ A_L value in nH for cores with air gap
(4 digits). For cores without air gap: 0000
 A_L -Wert in nH für Kerne mit Luftspalt
(4 Ziffern). Für Kerne ohne Luftspalt: 0000

■ Code letter for A_L tolerance
Kennbuchstabe für A_L -Toleranz
A $\pm 3\%$, J $\pm 5\%$, R $\pm 30\text{--}20\%$,
Y $\pm 40\text{--}30\%$

■ Code no. for material / Kennziffern für Material

Magnetisch geschlossene Schalenkernform, sehr streufeldarm

Diese Kerne eignen sich für

- Schwingkreisspulen (Filter) mit großer Induktivitätskonstanz und hoher Güte,
- klirrarmer breitbandiger Kleinsignalübertrager in den Werkstoffen T38 und N30.

- Für Leistungsanwendungen eignen sich P-Kerne ohne Mittelloch aus dem Werkstoff N87. Aufgrund des größeren effektiven magnetischen Querschnitts zeichnen sie sich durch einen höheren A_L -Wert, eine bessere Flussdichterverteilung und damit eine geringere Verlustleistung aus.

P 9 x 5 bis P 30 x 19 entsprechen IEC 60133, P 3.3 x 2.6 und P 5.8 x 3.3 nach IEC 62323.

Sie werden satzweise geliefert.

P Cores P 26 ... P 41

P-Kerne P 26 ... P 41

Technical data Technische Daten

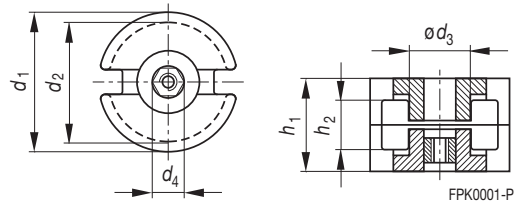

Type Typ	Air gap Luft- spalt	Material (Code number / Kennziffer) AL values (nH); AL tolerance code / AL-Werte (nH); AL-Toleranzbuchstabe						Ordering code (per set) Bestellnummer (pro Satz)						
		K1 (01)	M33 (33)	N48 (48)	N30 (30)	T38 (38)	N87 (87)							
Cores (Accessories on page 17) / Kerne (Zubehör siehe Seite 17)														
P 26 x 16	●	100	A	100, 160	A	160, 250, 315	A				B65671D0***A0** ¹⁾			
	●					400, 630, 800	A				B65671D0***A048 ¹⁾			
	●					1000	J				B65671D1000J048			
	○					4900	R				B65671D0000R048			
	○								9700	R	22000	Y	5500	R
P 30 x 19	●					250, 400, 630	A					B65701D0***A048 ¹⁾		
	●					1000	A					B65701D1000A048 ¹⁾		
	●					2000	J					B65701D2000J048		
	○					6200	R					B65701D0000R048		
	○								11500	R	28000	Y	6400	R
P 36 x 22	●					250, 400	A					B65611D0***A048 ¹⁾		
	●					630, 1000	A					B65611D****A048 ¹⁾		
	○					7600	R					B65611D0000R048		
	○								15200	R			B65611W0000R030	
P 41 x 25	●					250, 630	A					B65621J0***A048		
	●					3150	K					B65621J3150K048		
	○					8400	R					B65621J0000R048		

● = gapped / mit Luftspalt
○ = ungapped / ohne Luftspalt

1) Cores with threaded sleeve (version T) also available.
Kerne mit Gewindehülse (Version T) ebenfalls lieferbar.

*, +: See ordering code example
Siehe Bestellbeispiel

Magnetic characteristics (per set) / Magnetische Formkenngrößen (pro Satz)

Type Typ	$\Sigma I/A$ mm ⁻¹	l_e mm	A_e mm ²	A_{min} mm ²	V_e mm ³
P 26 x 16	0.40 (0.37)	37.2 (40.0)	93 (108)	76.5 (87)	3460 (4320)
P 30 x 19	0.33 (0.32)	45.0 (46.0)	136 (145)	- (117)	6120 (6670)
P 36 x 22	0.26 (0.25)	52.0 (53.5)	202 (213)	- (173)	10500 (11400)
P 41 x 25	0.257	62.1	242	200	15030

Values in parantheses for core sets without center hole
Werte in Klammern für Kernsätze ohne Mittelloch

Main dimensions (mm) / Hauptmaße (mm)

Type Typ	a	$\varnothing d_1$	$\varnothing d_2$	$\varnothing d_3$	h_1	h_2
P 26 x 16	26.0 -1.0	21.2 +0.8	11.5 -0.4	5.4 +0.2	16.3 -0.4	11.0 +0.4
P 30 x 19	30.5 -1.0	25.0 +0.8	13.5 -0.4	5.4 +0.2	19.0 -0.4	13.0 +0.4
P 36 x 22	36.0 -1.0	29.9 +0.8	16.2 -0.4	5.4 +0.3	22.0 -0.6	14.6 +0.4
P 41 x 25	41.0 -1.1	34.0 +0.9	17.5 -0.5	5.5 +0.2	25.0 -0.6	17.0 +0.6

Ordering code example / Bestellbeispiel

B65701D0400A048

Versions / Ausführungsarten

D, J

with center hole (without threaded sleeve)
mit Mittelloch (ohne Gewindehülse)

T

with center hole (with threaded sleeve)
mit Mittelloch (mit Gewindehülse)

W

Without center hole / ohne Mittelloch

■ Type / Bauform

■ Version / Ausführungsart

■ AL value in nH for cores with air gap
(4 digits). For cores without air gap: 0000
AL-Wert in nH für Kerne mit Luftspalt
(4 Ziffern). Für Kerne ohne Luftspalt: 0000

■ Code letter for AL tolerance
Kennbuchstabe für AL-Toleranz
A $\geq \pm 3\%$, J $\geq \pm 5\%$, K $\geq \pm 10\%$,
R $\geq +30/-20\%$, Y $\geq +40/-30\%$

■ Code number for material
Kennziffern für Material

Accessories for P Cores P 4.6 ... P 36

Zubehör für P-Kerne P 4.6 ... P 36

Technical data Technische Daten



Type Typ	Coil formers Spulenkörper			Mounting assemblies Halterung			Insulating washer Isolierscheibe
	Sections Kammern	Pins Stifte	Ordering code Bestellnummer	Pins Stifte	Ordering code Bestellnummer	Features Merkmale	
P 7 x 4	1	–	B65512C0000T001	5	B65512C2001X000	PTH Steckmontage	
P 9 x 5	1	–	B65522B0000T001	4	B65518D2001X000	PTH Steckmontage	
				6	B65518D2002X000	PTH Steckmontage	
	<u>SMD</u>	1	4	B65524C1004T001			Steckmontage Gullwing terminals
P 11 x 7	<u>SMD</u>	1	8	B65524C1008T001			
		1	–	B65532B0000T001	4	B65535B0002X000 B65535B0003X000	
P 14 x 8	1	–	B65542B0000T001	4	B65545B0009X000		B65542A5000X000
				6	B65545B0010X000		
P 18 x 11	1	–	B65652B0000T001	4	B65655B0009X000		B65652A5000X000
				8	B65655B0010X000		
P 22 x 13	1	–	B65662B0000T001	8	B65665C0004X000		B65662A5000X000
P 26 x 16	1	–	B65672B0000T001	8	B65675B0005X000		B65672B5000X000
P 30 x 19	1	–	B65702B0000T001	8	B65705B0003X000		B65702A5000X000
P 36 x 22	1	–	B65612B0000T001	10	B65615B0001X000		B65612A5000X000

EP Cores

EP-Kerne

Technical data Technische Daten



Type Typ	Air gap Luft- spalt	Material (Code number / Kennziffer) A _L values (nH); A _L tolerance code / A _L -Werte (nH); A _L -Toleranzbuchstabe							Ordering code ¹⁾ (per set) Bestellnummer ¹⁾ (pro Satz)		Coil formers ²⁾ Spulenkörper ²⁾				
		N45 (45)	N30 (30)	T38 (38)	T57 (57)	T65 (65)	T66 (66)	N87 (87)	Sections Kammern	Pins Stifte					
Cores / Kerne											Accessories / Zubehör				
EP 5	●			16, 25	A						B65855A00**A038				
	●			40	J						B65855A0040J038				
	●			63	D						B65855A0063D038				
	○	550	R	2000	Y	560	R		2200	Y	430	R	B65855A0000+0**		
EP 6	●			16, 25	A							B65855B00**A038			
	●			40	J							B65855B0040J038			
	●			63	D							B65855B0063D038			
	○	530	R	1900	Y	900	R		1700	Y	410	R	B65855B0000+0**		
EP 7	●	63, 100	A	63, 100	A	63, 100	A				63, 100	A	B65839A0***A0**		
	●	160	J	160	J	160	J				160	J	B65839A0160J0**	1	6
	●	200	C	200	C	200	C				200	C	B65839A0200C0**	2	6
	●	250	E	250	E	250	E				250	E	B65839A0250E0**	1	6
	○	1500	R	2000	R	1500	R	3000	R		1100	R	B65839A0000R0**		
	○			5200	Y				5800	Y			B65839A0000Y0**		
EP 10	●	63, 100	A	63, 100	A	63, 100	A				63, 100	A	B65841A0***A0**	1	8
	●	160	J	160	J	160	J				160	J	B65841A0160J0**	2	8
	●	200	C	200	C	200	C				200	C	B65841A0200C0**		
	●	250	E	250	E	250	E				250	E	B65841A0250E0**		
	○	1600	R	2000	R	1600	R	2900	R		1100	R	B65841A0000R0**		
	○			4800	Y				6000	Y			B65841A0000Y0**		
EP 13	●	63, 100	A	63, 100	A	63, 100	A		63, 100	A	63, 100	A	B65843A0063A0**	1	10
	●	160	B	160	B	160	B		160	B	160	B	B65843A0***B0**	2	10
	●	200	B	200	B	200	B		200	B	200	B	B65843A0200B0**		
	●	250	J	250	J	250	J		250	J	250	J	B65843A0250J0**		
	●	315	C	315	C	315	C		315	C	315	C	B65843A0315C0**		
	●	400	E	400	E	400	E		400	E	400	E	B65843A0400E0**		
	○	2400	R	2800	R	2500	R	4000	R		1600	R	B65843A0000R0**		
	○			7000	Y				8500	Y			B65843A0000Y0**		
EP 17	○		4300	R				6200	R		2400	R	B65845J0000R0**	1	8
	○			10800	Y				13000	Y			B65845J0000Y0**		
EP 20	●										200	A	B65847A0200A087	1	10
	○		6700	R				10200	R		4000	R	B65847A0000R0**	1	10
	○			18700	Y								B65847A0000Y038		

● = gapped / mit Luftspalt
○ = ungapped / ohne Luftspalt

1) *: See ordering code example / Siehe Bestellbeispiel
2) Pin versions for PTH coil formers on request. / Stiftvarianten für Stiftspulenkörper auf Anfrage.

For compact transformer

With their cubic geometry, EP cores are recommended for space-saving onboard solutions.

In conjunction with our materials, these models feature excellent characteristics for broadband, small-signal transformation with low leakage field.

EP core are consequently ideal for xDSL applications. Preferred materials, depending on conditions of use, are T38, T66, N45 and T57.

EP 7, 10, 13, 17 and 20 in accordance with IEC 61596.

EP cores are supplied in sets.

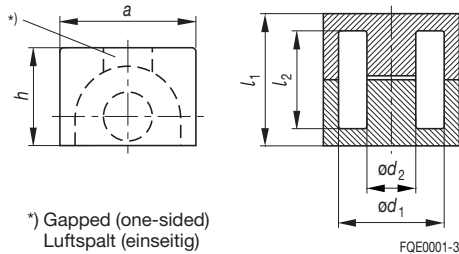

Example: EP 13
Beispiel: EP 13



Ordering code Bestellnummer	Features Merkmale	Yoke or cap Bügel oder Kappe
B65840B1006D001 B65840B1006D002 B65840N1106T001	PTH / Stifte PTH / Stifte Gullwing terminals	B65840D2000X000 (Cap / Kappe)
B65842W1008D001 B65842W1008D002	PTH / Stifte PTH / Stifte	B65842A2000X000 (Yoke / Bügel)
B65844W1010D001 B65844X1010D002	PTH / Stifte High-voltage	B65844A2000X000 (Yoke / Bügel)
B65846W1008D001	PTH / Stifte	B65846J2000X000 (Yoke / Bügel)
B65848D1010D001 B65848E1010D001	PTH / Stifte PTH / Stifte	B65848A2000X000 (Yoke / Bügel)

Magnetic characteristics (per set) / Magnetische Formkenngrößen (pro Satz)

Type Typ	$\Sigma I/A$ mm ⁻¹	l_e mm	A_e mm ²	A_{min} mm ²	V_e mm ³
EP 5	3.149	9.73	3.09	2.3	30
EP 6	3.359	10.28	3.06	2.3	31
EP 7	1.52	15.7	10.3	8.5	162
EP 10	1.70	19.2	11.3	8.5	217
EP 13	1.24	24.2	19.5	14.9	472
EP 17	0.84	28.5	33.9	25.5	966
EP 20	0.51	40.0	78.0	60.0	3120

Main dimensions (mm) / Hauptmaße (mm)

Type Typ	a	h	$\varnothing d_1$	$\varnothing d_2$	l_1	l_2
EP 5	6.15 -0.3	3.9 -0.25	4.3 +0.25	1.8 -0.15	5.7 -0.2	3.8 +0.4
EP 6	6.15 -0.3	3.9 -0.25	4.3 +0.25	1.8 -0.15	6.1 -0.2	4.2 +0.4
EP 7	9.4 -0.4	6.5 -0.3	7.2 +0.4	3.4 -0.2	7.5 -0.2	5.0 +0.4
EP 10	11.8 -0.6	7.85 -0.4	9.2 +0.4	3.45 -0.3	10.4 -0.2	7.2 +0.4
EP 13	12.8 -0.6	9.0 -0.4	9.7 +0.6	4.5 -0.3	13.0 -0.3	9.0 +0.4
EP 17	18.4 -0.8	11.25 -0.3	11.6 +0.8	5.85 -0.35	17.0 -0.6	11.0 +0.6
EP 20	24.5 -1.0	15.3 -0.7	16.1 +0.8	9.0 -0.5	21.6 -0.4	14.0 +0.6

Ordering code example / Bestellbeispiel

B65839A0100A087

- Type / Bauform
- Version / Ausführungsart
- A_L value in nH for cores with air gap (4 digits). For cores without air gap: 0000
 A_L -Wert in nH für Kerne mit Luftspalt (4 Ziffern). Für Kerne ohne Luftspalt: 0000
- Code letter for A_L tolerance
Kennbuchstabe für A_L -Toleranz
A $\cong \pm 3\%$, B $\cong \pm 4\%$, C $\cong \pm 6\%$
D $\cong \pm 8\%$, E $\cong \pm 7\%$, J $\cong \pm 5\%$
R $\cong +30/-20\%$, Y $\cong +40/-30\%$
- Code number for material
Kennziffern für Material

Für kompakte Übertrager

EP-Kerne empfehlen sich wegen ihrer kubischen Geometrie für Raum sparenden Aufbau auf der Leiterplatte.

In Verbindung mit unseren Ferrit-Werkstoffen liefert diese Bauform ausgezeichnete Eigenschaften für breitbandige, streufeldarme Kleinsignalübertragung.

EP-Kerne eignen sich daher hervorragend für xDSL-Anwendungen. Bevorzugte Werkstoffe sind je nach Einsatzbedingungen T38, T66, N45 und T57.

EP 7, 10, 13, 17 und 20 entsprechen IEC 61596.

EP-Kerne werden satzweise geliefert.

EPX/EPO Cores

EPX-/EPO-Kerne

Technical data Technische Daten

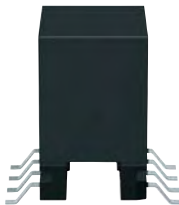

Type Typ	Air gap Luft- spalt	Material (Code number / Kennziffer) AL values (nH); AL tolerance code / AL-Werte (nH); AL-Toleranzbuchstabe				Ordering code (per set) Bestellnummer (pro Satz)		Coil formers Spulenkörper					
		N45 (45)	T38 (38)	T57 (57)	T66 (66)	Sections Kammern	Pins Stifte						
Cores / Kerne								Accessories / Zubehör					
EPX 7/9	●	63, 100	A	63, 100	A	63, 100	A	63, 100	A	B65857A0***A0**	SMD	1	8
	●	160, 200	B	160, 200	B	160, 200	B	160, 200	B	B65857A0***B0**			
	●	250	J	250	J	250	J	250	J	B65857A0250J0**			
	●	315	C	315	C	315	C	315	C	B65857A0315C0**			
	●	400	E	400	E	400	E	400	E	B65857A0400E0**			
	○	2500	R			2600	R			B65857A0000R0**			
EPX 9/9	●	63, 100	A	63, 100	A	63, 100	A	63, 100	A	B65857C0***A0**	SMD	1	8
	●	160, 200	B	160, 200	B	160, 200	B	160, 200	B	B65857C0***B0**			
	●	250	J	250	J	250	J	250	J	B65857C0250J0**			
	●	315	C	315	C	315	C	315	C	B65857C0315C0**			
	●	400	E	400	E	400	E	400	E	B65857C0400E0**			
	○	2400	R			2400	R			B65857C0000R0**			
EPX 10	●			63, 100	A	63, 100	A			B65859A0***A0**			
	●			160	J	160	J			B65859A0160J0**			
	●			200	C	200	C			B65859A0200C0**			
	●			250	E	250	E			B65859A0250E0**			
	○					2000	R			B65859A0000R057			
EPO 13	●			63	A	63	A			B65843P0063A0**		1	10
	●			100	A	100	A			B65843P0100A0**			
	●			160, 200	B	160, 200	B			B65843P0***B0**			
	●			250	J	250	J			B65843P0250J0**			
	●			315	C	315	C			B65843P0315C0**			
	●			400	E	400	E			B65843P0400E0**			
	○					2400	R			B65843P0000R057			
	○			6600	Y					B65843P0000Y038			

● = gapped / mit Luftspalt
○ = ungapped / ohne Luftspalt

*: See ordering code example
Siehe Bestellbeispiel

EPX cores from EPCOS are patented. / EPX-Kerne von EPCOS sind patentiert.
US: publication no. US-2002-0158743 / DE: application no. 10056945.5

Optimized ferrite cores for xDSL applications

Internet access with DSL is the fastest growing broadband technology.

For the new requirements EPCOS has created ferrite cores and materials for DSL line transformers. These new EPX and EPO cores increase loop reach at a given data rate for DSL applications.

The major goal of all developments is miniaturization of the line transformer without any performance degradation. The lines per board can be increased, which enables further cost reduction.

EPX and EPO cores and supplied in sets.

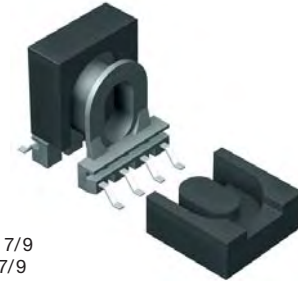

Example: EPX 7/9
Beispiel: EPX 7/9

Magnetic characteristics (per set) / Magnetische Formkenngrößen (pro Satz)

Type Typ	$\Sigma I/A$ mm ⁻¹	I_e mm	A_e mm ²	A_{min} mm ²	V_e mm ³
EPX 7/9	0.91	15.7	17.2	13.9	270
EPX 9/9	1.09	19.0	17.5	13.9	333
EPX 10	1.37	21.7	15.9	13.2	345
EPO 13	1.34	25.8	19.3	14.9	498

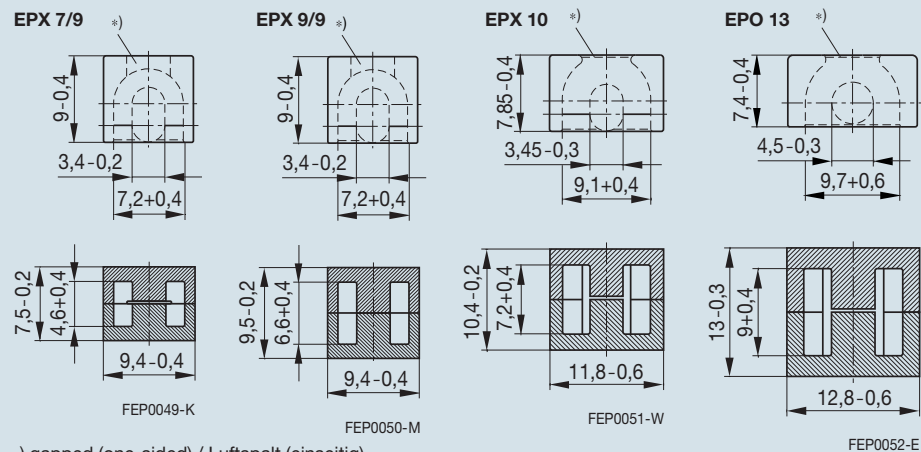

*) gapped (one-sided) / Luftspalt (einseitig)

Ordering code example / Bestellbeispiel

B65857A0160B066

- Type / Bauform
- Version / Ausführungsart
- A_L value in nH for cores with air gap (4 digits). For cores without air gap: 0000
 A_L -Wert in nH für Kerne mit Luftspalt (4 Ziffern). Für Kerne ohne Luftspalt: 0000
- Code letter for A_L tolerance
Kennbuchstabe für A_L -Toleranz
A $\geq \pm 3\%$, B $\geq \pm 4\%$, C $\geq \pm 6\%$
E $\geq \pm 7\%$, J $\geq \pm 5\%$, R $\geq +30/-20\%$
Y $\geq +40/-30\%$
- Code number for material
Kennziffern für Material

Optimierte Ferritkerne für xDSL-Anwendungen

Internet-Zugang mit DSL ist die am schnellsten wachsende Breitband-Technologie. Für entsprechende neue Anforderungen hat EPCOS Ferritkerne und -werkstoffe für DSL-Schnittstellenübertrager entwickelt. Die neuen EPX- und EPO-Kerne erhöhen bei gegebener Übertragungsrates die Reichweite der Teilnehmerleitungen bei DSL-Anwendungen.

Mit diesen Neuentwicklungen gelang eine Miniaturisierung der DSL-Schnittstellenübertrager, ohne deren Leistung zu mindern. Durch die Erweiterung der Anschlüsse pro Baugruppe werden Kosteneinsparungen ermöglicht. EPX- und EPO-Kerne werden satzweise geliefert.

P Core Halves Einzelschalen

Technical data Technische Daten



Type Typ	Material			Ordering code Bestellnummer	Coil formers Spulenkörper
	N22	M33	N27		
Cores / Kerne					Accessories / Zubehör
PS 7.35 x 3.6	X			B65933A0000X022	B65512C0000T001
		X		B65933A0000X033	
PS 9 x 3.5	X			B65935E0000X022	B65936A0000T001
		X		B65935E0000X033	
PCH 14 x 7.5	X			B65937A0000X022	B65542B0000T001
PS 25 x 8.9	X			B65939A0000X022	B65940B0000T001
PS 30.5 x 10.2	X			B65941A0000X022	B65942B0000T001
PS 35 x 10.8	X			B65947A0000X022	
PS 47 x 14.9	X			B65943A0000X022	
PS 68 x 14.5	X			B65928A0000X022	B65946B0000T001
PCH 70 x 14.5	X			B65945A0000X022	B65946B0000T001
PCH 150 x 30			X	B65949A0000X027	

P core halves for inductive proximity switches

Inductive proximity switches can be used as noncontacting motion detectors and output indicators.

Pot core halves are matched to standard switches in their dimensions. Maximum operating distances can thus be achieved for individual P core sizes.

Cores with the "PS" designation have been standardized to IEC 62323.

Material choice:

- up to 1 MHz: N22
- up to 2 MHz: M33

Main dimensions (mm) / Hauptmaße (mm)

Type Typ	d ₁	Ø d ₂	Ø d ₃	Ø d ₄	h ₁	h ₂
PS 25 x 8.9	24.8 -1.0	20.5 +0.8	11.3 -0.5	5.2 +0.4	8.9 -0.2	5.9 +0.3
PS 30.5 x 10.2	30.5 -1.0	25.0 +0.8	13.5 -0.4	5.4 +0.2	10.2 -0.5	7.0 +0.4
PS 35 x 10.8	35.0 -1.0	29.2 +1.2	15.7 -0.6	5.3 +0.3	10.8 -0.5	7.2 +0.4
PS 47 x 14.9	47.0 -1.3	39.0 +1.8	20.0 -0.6	5.5 +0.2	14.9 -0.7	10.0 +0.5

PS 25 x 8.9 / PS 30.5 x 10.2

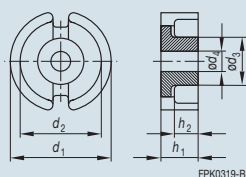

FPK0319-B

PS 35 x 10.8 / PS 47 x 14.9

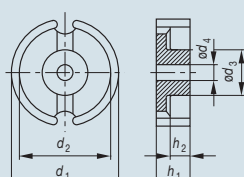

FPK0320-E

PS 7.35 x 3.6

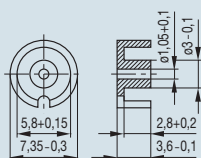

FPK0314-5

PS 9 x 3.5

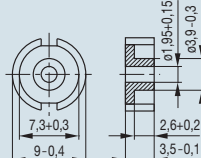

FPK0315-D

PCH 14 x 7.5

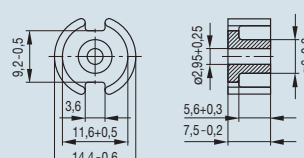

FPK0218-W

PS 68 x 14.5

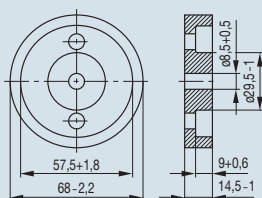

FPK0321-M

PCH 70 x 14.5

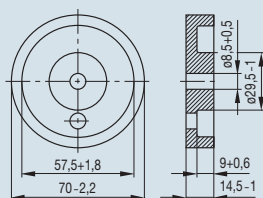

FPK0322-V

PCH 150 x 30

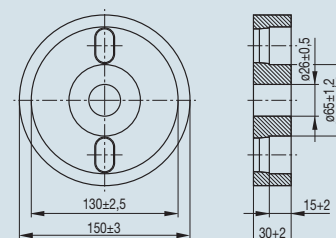

FPK0323-4

Einzelschalen für induktive Näherungsschalter

Mit induktiven Näherungsschaltern lassen sich Bewegungsabläufe und Schaltzustände berührungslos erfassen.

Hinsichtlich der Abmessungen sind Einzelschalen an die genormten Schalter angepasst. Damit können für die Schalenkerngrößen jeweils maximale Schaltabstände erreicht werden.

Kerne mit der Bezeichnung „PS“ sind nach IEC 62323 genormt.

Werkstoffauswahl:

- bis 1 MHz: N22
- bis 2 MHz: M33

PM Cores

PM-Kerne

Technical data Technische Daten



Industrial

Type Typ	Air gap Luft- spalt	Material A _L values (nH) / A _L -Werte (nH)		Ordering code (per set) Bestellnummer (pro Satz)	Coil formers Spulenkörper		
		N27	N87		Sections Kammern	Solder pins Lötanschlüsse	Ordering code Bestellnummer
Cores / Kerne					Accessories / Zubehör		
PM 50/39	●	250 ±3%		B65646A0250A027	1	14	B65647B1014T001
	●	630 ±3%		B65646A0630A027			
	○	7400 +30/-20%		B65646A0000R027			
	○		7400 +30/-20%	B65646A0000R087			
PM 62/49	●	315 ±3%		B65684A0315A027	1	-	B65685B1016T001 B65685A1000T001
	●	630 ±3%		B65684A0630A027	1		
	○	9200 +30/-20%		B65684A0000R027			
	○		9200 +30/-20%	B65684A0000R087			
PM 74/59	●	315 ±3%		B65686A0315A027	1	18	B65687A1018T001 B65687A1000T001
	●	630 ±3%		B65686A0630A027	1		
	○	10000 +30/-20%		B65686A0000R027			
	○		10000 +30/-20%	B65686A0000R087			
PM 87/70	●	400 ±3%		B65713A0400A027	1	20	B65714K1020T001 B65714J1000T001
	●	5000 ±15%		B65713A5000L027	1		
	○	12000 +30/-20%		B65713A0000R027			
	○	12000 +30/-20%		B65713A0000R087			
PM 114/93	●	630 ±3%		B65733A0630A027	1	-	B65734B1000T001
	●	6300 ±15%		B65733A6300L027			
	○	16000 +30/-20%		B65733A0000R027			
	○	16000 +30/-20%		B65733A0000R087			

● = gapped / mit Luftspalt
○ = ungapped / ohne Luftspalt

1) Complete mounting assembly incl. nuts and washers
Komplette Halterung mit Muttern und Scheiben

PM cores for handling very high powers

The benefits of this pot core have been proven in numerous applications in telecommunications and industrial electronics:

- wide flux area for high power at minimum number of turns,

- low magnetic leakage and stray capacitance,
- a good shielding owing to the closed form,
- precisely ground air gaps.

PM cores are in accordance with IEC 61247.
They are supplied in sets.

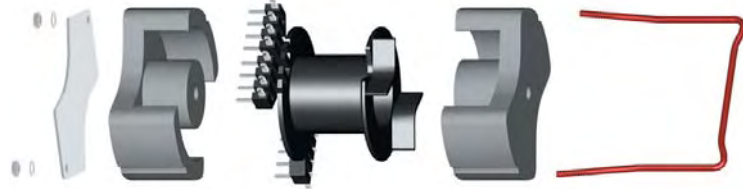
**Mounting assemblies¹⁾
Halierung¹⁾**

B65647A2000X000

B65685A2000X000

B65687A2000X000

Magnetic characteristics (per set) / Magnetische Formkenngrößen (pro Satz)

Type Typ	$\Sigma I/A$ mm ⁻¹	l_e mm	A_e mm ²	A_{min} mm ²	V_e mm ³
PM 50/39	0.227	84	370	280	31000
PM 62/49	0.191	109	570	470	62000
PM 74/59	0.162	128	790	630	101000
PM 87/70	0.160	146	910	700	133000
PM 114/93	0.116	200	1720	1380	344000

Main dimensions (mm) / Hauptmaße (mm)

Type Typ	d_1	$\varnothing d_2$	$\varnothing d_3$	$\varnothing d_4$	h_1	h_2
PM 50/39	50 -1.7	39.0 +1.3	20.0 -0.6	5.4 +0.2	39 -0.4	26.4 +0.8
PM 62/49	62 -2.0	48.8 +1.5	25.5 -0.8	5.4 +0.2	49 -0.4	33.4 +0.8
PM 74/59	74 -2.5	57.5 +1.8	29.5 -1.0	5.4 +0.3	59 -0.6	40.7 +0.8
PM 87/70	87 -3.0	67.1 +2.1	31.7 -1.0	8.5 +0.3	70 -0.8	48.0 +0.8
PM 114/93	114 -4.5	88.0 +3.7	43.0 -1.4	5.4 +0.4	93 -1.0	63.0 +1.6

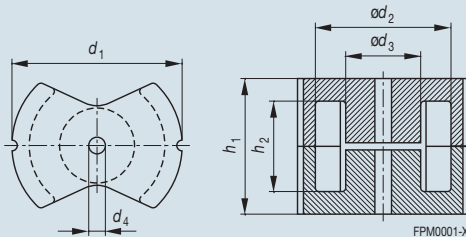
PM-Kerne für die Übertragung sehr hoher Leistungen

In zahlreichen Anwendungen in der Nachrichtentechnik und Industrieelektronik hat sich diese Schalenkernform als vorteilhaft erwiesen:

- Großer Flussquerschnitt, daher günstig für hohe Leistungen bei wenig Windungszahlen,

- geringe Streuinduktivität und Eigenkapazität,
- gute Schirmung durch kompakte Form,
- die Möglichkeit, einen Luftspalt sehr genau einzuschleifen.

PM-Kerne entsprechen IEC 61247.
Sie werden satzweise geliefert.

U/I Cores

U-/I-Kerne

Technical data Technische Daten



Type Typ	Material A _L values (nH) / A _L -Werte (nH)		Ordering code (per piece) Bestellnummer (pro Stück)
	N27	N87	

U cores / U-Kerne¹⁾

U 93/76/16	2900 +30/-20%	3100 +30/-20%	B67345B0003X027
			B67345B0003X087
U 93/76/20	3600 +30/-20%	3900 +30/-20%	B67345B0010X027
			B67345B0010X087
U 93/76/30	5400 +30/-20%	5700 +30/-20%	B67345B0001X027
			B67345B0001X087
U 101/76/30	4600 +30/-20%	5700 +30/-20%	B67370A0002X027
			B67370A0002X087
U 126/91/20	7500 ±30%	3000 ±25%	B67385G0000X187
U 141/78/30	7500 ±30%	8900 ±30%	B67374G0000X127
			B67374G0000X187

I cores / I-Kerne²⁾

I 93/28/16	3800 +30/-20%	4100 +30/-20%	B67345B0004X027
			B67345B0004X087
I 93/28/20	4900 +30/-20%	5300 +30/-20%	B67345B0011X027
			B67345B0011X087
I 93/28/30	7400 +30/-20%	7900 +30/-20%	B67345B0002X027
			B67345B0002X087
I 126/28/20		3900 ±25%	B67385P0000X187

1) A_L values apply to an UU core set.
A_L-Werte gelten für einen UU-Kernsatz.

2) A_L values apply to an UI core set.
A_L-Werte gelten für einen UI-Kernsatz.

For power, pulse and high-voltage transformers

■ U cores with a rectangular cross-section are a low-cost but somewhat bulky core form. Offering various combination possibilities, they are preferred for high-power transformation and can be used into the kW region.

■ I cores combined with U cores allow the design of simple transformers.

U and I cores are supplied in single units.

U 93 ... U 126

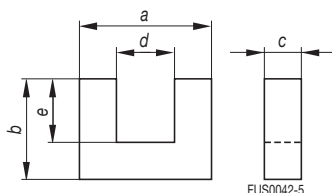

I 93 ... I 126

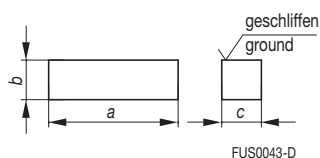

U 141

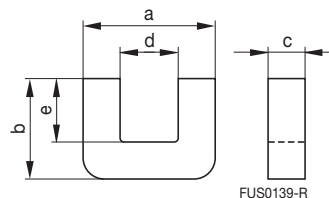
**Magnetic characteristics (per set) / Magnetische Formkenngrößen (pro Satz)**

Type Typ	$\Sigma I/A$ mm ⁻¹	l_e mm	A_e mm ²	A_{min} mm ²	V_e mm ³
U 93/76/16 ¹⁾	0.79	354	448	448	159000
U 93/76/20 ¹⁾	0.63	354	560	560	198000
U 93/76/30 ¹⁾	0.42	354	840	840	297000
U 101/76/30 ¹⁾	0.44	368	840	840	310800
U 126/91/20 ¹⁾	0.86	480	560	560	269000
U 141/78/30 ¹⁾	0.28	377	1350	1350	508950
I 93/28/16 ²⁾	0.58	258	448	448	116000
I 93/28/20 ²⁾	0.46	258	560	560	144000
I 93/28/30 ²⁾	0.31	258	840	840	217000
I 126/28/20 ²⁾	0.63	354	560	560	198000

1) UU core set
2) UI core set

Main dimensions (mm) / Hauptmaße (mm)

Type Typ	a	b	c	d	e
U 93/76/16	93.0 ±1.8	76.0 ±0.5	16.0 ±0.5	34.6 min.	48.0 ±0.9
I 93/28/16	93.0 ±1.8	28.0 ±0.5	16.0 ±0.5	–	–
U 93/76/20	93.0 ±1.8	76.0 ±0.5	20.0 ±0.5	34.6 min.	48.0 ±0.9
I 93/28/20	93.0 ±1.8	28.0 ±0.5	20.0 ±0.5	–	–
U 93/76/30	93.0 ±1.8	76.0 ±0.5	30.0 ±0.6	34.6 min.	48.0 ±0.9
I 93/28/30	93.0 ±1.8	28.0 ±0.5	30.0 ±0.6	–	–
U 101/76/30	101.0 ±1.8	76.0 ±0.5	30.0 ±0.6	45.0 min.	48.0 ±0.9
U 126/91/20	126.0 ±4	91.0 ±1	20.0 ±0.6	70.0 ±2	63.0 ±2
I 126/28/20	126.0 ±4	28.0 ±1	20.0 ±0.6	–	–
U 141/78/30	141.0 ±5	78.5 ±0.5	30.0 ±1	50.0 min.	33.5 ±1

Für Leistungs-, Impuls- und Hochspannungsüber-träger

■ U-Kerne mit rechteckiger Querschnittsfläche sind preisgünstige, jedoch etwas sperrige Kernformen. Für hohe übertragbare Leistungen werden sie jedoch bevorzugt verwendet, da sie durch verschiedene Kombinationsmöglichkeiten Leistungsübertragungen bis in den kW-Bereich ermöglichen.

■ I-Kerne in Kombination mit U-Kernen erlauben den Aufbau einfacher Übertrager.

U- und I-Kerne werden stückweise geliefert.

E Cores E 5 ... E 20

E-Kerne E 5 ... E 20

Technical data Technische Daten



Type Typ	Air gap Luft- spalt	Material (Code number / Kennziffer) A _L values (nH) or dim. g (mm) for cores with air gap A _L -Werte (nH) bzw. Maß g (mm) für Kerne mit Luftspalt							Ordering code (per piece) Bestellnummer (pro Stück)	Coil formers Spulenkörper					
		N45 (45)	N30 (30)	T38 (38)	T46 (46)	N27 (27)	N41 (41)	N87 (87)		Sections Kammern	Pins Stifte				
Cores / Kerne										Accessories / Zubehör					
E 5 ²⁾	○			1400				270	B66303G0000X1**						
E 6.3 ²⁾	○		700 +40/-30%	1700				380	B66300G0000X1**	SMD	1 4				
											1 6				
E 8.8 ²⁾	○		1000	2100				550	B66302G0000X1**	SMD	1 8				
											2 8				
E 10/5.5/5	○						750 ±25%	800 ±25%	B66322G0000X1**						
E 13/7/4 ²⁾	○	950	1000		3600			800	850	B66305G0000X1**	1 8				
											1 6				
										●		0.04		B66305G0040X127	SMD
										2 10					
E 14/8/4	○		1250				860	1050	B66219G0000X1**						
E 16/6/5	○						1100		B66393G0000X1**						
E 16/8/5 ²⁾	○	1400	1400		5100			950	1000	B66307G0000X1**	1 8				
												B66307F0000X146	1 8		
										●		0.06	0.06	B66307G0060X1**	
										●		0.1/0.5	0.1/0.5	B66307G0***X1**	
E 19/8/5 ¹⁾	○		1700	5800	1050		1150	B66379G0000X1**							
E 20/10/6 ²⁾	○		2150					1300	1470	B66311G0000X1**	1 10				
										●		0.09	0.09	B66311G0090X1**	1 10
										●		0.17	0.17	B66311G0170X1**	1 12
										●		0.25	0.25	B66311G0250X1**	1 14
										●		0.5	0.5	B66311G0500X1**	1 6
										2 6					
Tol. of A _L value		+30%	+30%	+40/	±30%	+30/	+30/	+30/							
A _L -Wert-Toleranz		-20%	-20%	-30%		-20%	-20%	-20%							

● = gapped / mit Luftspalt
○ = ungapped / ohne Luftspalt

*: See ordering code example
Siehe Bestellbeispiel

1) Size corresponds to U.S. lam size E cores E187.
Größe entspricht U.S. lam size E cores E187.
2) In accordance with IEC 61246

Conventional E cores with rectangular center leg (E 5 through E 80)

These E cores are available in a wide variety of sizes. The main areas of use are power transformers and chokes for switch-mode power supplies and also small-signal applications. The disadvantages of an unfavorable winding

form and the intensive leakage field produced by the geometry are countered by the major advantage of a simple core form that is economical to produce.

E cores are supplied in single units.

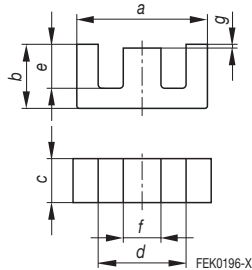
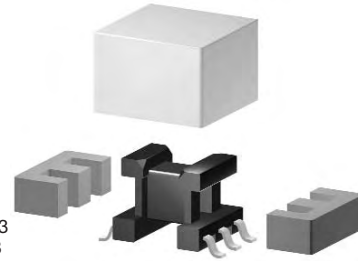
 Example: E 6.3
 Beispiel: E 6.3

Ordering code Bestellnummer	Features Merkmale	Mounting assemblies Halterung
B66301B1004T001 B66301B1006T001 B66301B1006T002	Gullwing terminals	B66301C2000X000 (Cap / Kappe)
B66302D1008T001 B66302D1008T002	Gullwing terminals	B66302A2000X000 (Cap / Kappe)
B66202A1108T001 B66202J1106T001	horizontal vertical	B66202A2010X000 (Yoke / Bügel)
B66306C1010T001 B66306C1010T002	Gullwing terminals	B66414A7000X000 (cover plate / Abdeckplatte)
B66308A1108T001 B66308J1108T001	horizontal vertical	B66308A2010X000 (Yoke / Bügel)
B66206A1110T001 B66206J1110T001	horizontal vertical	B66206A2010X000 (Yoke / Bügel)
B66206C1012T001 B66206C1014T001	right-angle pins Winkelstifte	
B66206J1106T001 B66206K1106T002	for luminaire für Leuchten- technik	B66206A2001X000 (Yoke / Bügel)

Magnetic characteristics (per set) / Magnetische Formkenngrößen (pro Satz)

Type Typ	$\Sigma I/A$ mm ⁻¹	l_e mm	A_e mm ²	A_{min} mm ²	V_e mm ³
E 5	4.86	12.6	2.6	2.5	33
E 6.3	3.70	12.2	3.3	2.6	40.3
E 8.8	3.10	15.5	5.0	3.6	78
E 10/5.5/5	2.41	26.3	10.9	10.4	287
E 13/7/4	2.39	29.6	12.4	12.2	367
E 14/8/4	2.19	33.9	15.5	13.1	525
E 16/6/5	1.49	28.6	19.2	17.6	549
E 16/8/5	1.87	37.6	20.1	19.4	756
E 19/8/5	1.76	39.6	22.5	22.1	891
E 20/10/6	1.44	46.3	32.1	31.9	1490

Main dimensions (mm) / Hauptmaße (mm)

Type Typ	a	b	c	d	e	f
E 5	5.25 ±0.1	2.65 ±0.05	2.0 -0.1	3.9 ±0.1	1.93 +0.15	1.35 ±0.05
E 6.3	6.3 -0.25	2.9 -0.1	2.0 -0.1	3.6 +0.2	1.85 +0.15	1.4 -0.1
E 8.8	9.0 ±0.25	4.1 -0.2	2.0 -0.1	5.2 ±0.13	2.03 +0.25	1.9 ±0.12
E 10/5.5/5	10.2 ±0.2	5.5 ±0.15	4.8 -0.3	7.95 ±0.15	4.25 ±0.15	2.35 ±0.15
E 13/7/4	12.6 +0.5/-0.4	6.5 -0.2	3.7 -0.3	8.9 +0.6	4.5 +0.3	3.7 -0.3
E 14/8/4	14.3 -0.7	7.8 -0.3	4.3 -0.3	10.5 +0.6	5.2 +0.4	4.3 -0.3
E 16/6/5	16.0 +0.7/-0.5	5.8 -0.2	4.7 -0.4	11.3 +0.6	3.6 +0.3	4.7 -0.3
E 16/8/5	16.0 +0.7/-0.5	8.2 -0.3	4.7 -0.4	11.3 +0.6	5.7 +0.4	4.7 -0.3
E 19/8/5	19.0 ±0.4	8.0 ±0.13	4.8 ±0.2	14.3 ±0.3	5.7 ±0.13	4.8 ±0.2
E 20/10/6	20.4 -0.8	10.1 -0.3	5.9 -0.4	14.1 +0.6	7.0 +0.3	5.9 -0.3

Ordering code example / Bestellbeispiel
B66311G0500X127

- Type / Bauform
- Code letter for tolerated air gap / Kennzeichen für tolerierten Luftspalt
- Air gap "dim. g" in thousandths of millimeter (4 digits). "0000" for cores w/o air gap.
Luftspalt „Maß g“ in tausendstel Millimeter (4 Ziffern). „0000“ bei Kernen ohne Luftspalt.
- Filling number / Füllnummer
- Code number for material / Kennziffern für Material

**Klassische E-Kerne mit eckigem Mittelschenkel
(E 5 bis E 80)**

Für diese E-Kernform steht eine Vielzahl von Größen zur Verfügung. Die Hauptanwendungsfelder sind Leistungsübertrager und Drosseln für SNT, jedoch auch Kleinsignalanwendungen. Dem Nachteil der ungünstigen

Wickelform und der streufeldintensiven Geometrie steht der große Vorteil einer einfachen und wirtschaftlich günstig zu fertigen Kernform gegenüber.

E-Kerne werden stückweise geliefert.

E Cores E 21 ... E 36

E-Kerne E 21 ... E 36

Technical data Technische Daten



Type Typ	Air gap Luft- spalt	Material (Code number / Kennziffer) A _L values (nH) or dim. g (mm) for cores with air gap A _L -Werte (nH) bzw. Maß g (mm) für Kerne mit Luftspalt				Ordering code (per piece) Bestellnummer (pro Stück)	Coil formers Spulenkörper	
		N30 (30)	T46 (46)	N27 (27)	N87 (87)		Sections Kammern	Pins Stifte
Cores / Kerne							Accessories / Zubehör	
E 21/9/5	○	1500		900		B66314G0000X1**		
E 25/13/7 ²⁾	○	2900		1750	1850	B66317G0000X1**	1	10
	●			0.1	0.1	B66317G0100X1**	1	10
	●			0.16	0.16	B66317G0160X1**	1	10
	●			0.25	0.25	B66317G0250X1**	1	9
	●			0.5	0.5	B66317G0500X1**		
	●			1.0	1.0	B66317G1000 X1**		
E 25.4/10/7 ¹⁾	○	2700		1500	1670	B66315G0000X1**		
	○		8500			B66315F0000X146		
	●			0.5		B66315G0500X127		
E 30/15/7	○	3100		1700	1900	B66319G0000X1**	1	14
	●			0.1	0.1	B66319G0100X1**	1	14
	●			0.18	0.18	B66319G0180X1**	1	12
	●			0.34	0.34	B66319G0340X1**		
E 32/16/9 ²⁾	○	3800		2100	2300	B66229G0000X1**	1	14
	●			0.5	0.5	B66229G0500X1**		
	●			1.0	1.0	B66229G1000X1**		
E 32/16/11	○			2900	B66233G0000X187			
E 34/14/9 ¹⁾	○			2300	2450	B66370G0000X1**		
E 36/18/11	○			2900	3100	B66389G0000X1**	1	16
	●			1.0		B66389G1000X127		
Tol. of A _L value A _L -Wert-Toleranz		+30/-20%	±30	+30/-20%	+30/-20%			

● = gapped / mit Luftspalt
○ = ungapped / ohne Luftspalt

** : Code number for material
Kennziffer für Werkstoff

1) Size corresponds to U.S. lam size E cores
Größe entspricht U.S. lam size E cores
E25.4/10/7 Δ E2425; E34/14/9 Δ E375

2) In accordance with IEC 61246

For power applications material with low power loss is needed.

If high saturation characteristics are required in addition to low power loss, inquire for material N92.

We recommend:

- N27 up to 100 kHz
- N87 up to 500 kHz

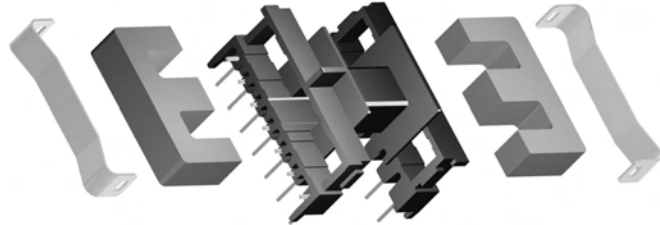
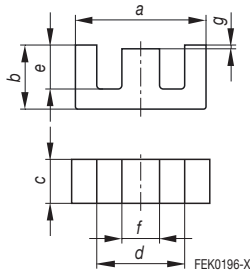

Ordering code Bestellnummer	Features Merkmale	Yoke Bügel
B66208A1110T001	horizontal	B66208A2010X000
B66208J1110T001	vertical	
B66208W1010T001	vertical	
B66208K1009T001	for SMPS für SNT	B66208A2003X000
B66232A1114T001	horizontal	B66232A2010X000
B66232B1114T001	horizontal	
B66232J1112T001	vertical	
B66230A1114T001	horizontal	B66230A2010X000
B66390A1016T001	horizontal	

Magnetic characteristics (per set) / Magnetische Formkenngrößen (pro Satz)

Type Typ	$\Sigma I/A$ mm ⁻¹	l_e mm	A_e mm ²	A_{min} mm ²	V_e mm ³
E 21/9/5	2.01	43.4	21.6	20.2	937
E 25/13/7	1.10	57.5	52.5	51.5	3020
E 25.4/10/7	1.27	49.2	38.8	38.4	1910
E 30/15/7	1.12	67	60	49.0	4000
E 32/16/9	0.89	74	83	81.4	6140
E 32/16/11	0.76	74	97	95.0	7187
E 34/14/9	0.82	69.6	84.8	83.2	5900
E 36/18/11	0.68	81	120	112	9670

Main dimensions (mm) / Hauptmaße (mm)

Type Typ	a	b	c	d	e	f
E 21/9/5	21.1 -1.0	8.7 -0.4	5.0 -0.4	16.0 +0.8	6.0 +0.4	5.0 -0.4
E 25/13/7	25.0 +0.8/-0.7	12.8 -0.5	7.5 -0.6	17.5 +0.8	8.7 +0.5	7.5 -0.5
E 25.4/10/7	25.4 ±0.7	9.78 -0.15	6.5 -0.5	18.8 +0.8	6.48+0.3	6.5 -0.4
E 30/15/7	30.0 +0.8/-0.6	15.2 -0.4	7.3 -0.5	19.5 +0.8	9.7 +0.6	7.2 -0.5
E 32/16/9	32.0 +0.9/-0.7	16.4 -0.6	9.5 -0.7	22.7 +1.0	11.2 +0.6	9.5 -0.6
E 32/16/11	32.0 +0.7/-0.5	16.4 -0.6	11.0 -0.7	22.7 +1.0	11.2 +0.6	9.5 -0.6
E 34/14/9	34.6 ±0.7	14.65 -0.75	9.7 -0.8	25.1 +1.0	9.5 +0.5	9.65 -0.55
E 36/18/11	36.0 +1.0/-0.7	18.0 -0.4	11.5 -0.5	24.5 +1.2	12.0 +0.6	10.2 -0.5

Ordering code example / Bestellbeispiel

B66317G1000X127

- Type / Bauform
- Code letter for tolerated air gap / Kennzeichen für tolerierten Luftspalt
- Air gap "dim. g" in thousandths of millimeter (4 digits). "0000" for cores w/o air gap.
Luftspalt „Maß g“ in tausendstel Millimeter (4 Ziffern). „0000“ bei Kernen ohne Luftspalt.
- Filling number / Füllnummer
- Code number for material / Kennziffern für Material

Für Leistungsanwendungen werden Werkstoffe mit geringen Verlustleistungen benötigt.

- Geeignete Werkstoffe:
- N27 bis ca. 100 kHz
 - N87 bis 500 kHz

Werden zusätzlich noch hohe Sättigungseigenschaften verlangt, empfehlen wir den Werkstoff N92, der auf Anfrage erhältlich ist.

E Cores E 40 ... E 80

E-Kerne E 40 ... E 80

Technical data Technische Daten



Type Typ	Air gap Luft- spalt	Material (Code number / Kennziffer) A _L values (nH) or dim. g (mm) for cores with air gap A _L -Werte (nH) bzw. Maß g (mm) für Kerne mit Luftspalt			Ordering code (per piece) Bestellnummer (pro Stück)	Coil formers Spulenkörper	
		N27 (27)	N87 (87)	N72 (72)		Sections Kammern	Pins Stifte
Cores / Kerne						Accessories / Zubehör	
E 40/16/12 ¹⁾	○	3800	4150	4600	B66381G0000X1**	1	14
	●	0.5			B66381G0500X127		
E 42/21/15 ²⁾	○	3500	3950		B66325G0000X1**		
	●	0.1/0.25/0.5/0.64			B66325G0***X127		
	●	1.0/1.5			B66325G***X127		
E 42/21/20 ²⁾	○	4750	5200		B66329G0000X1**	1	18
	●	0.25/0.5			B66329G0***X127		
	●	1.0/1.5			B66329G***X127		
E 47/20/16 ¹⁾	○	5100	5600		B66383G0000X1**		
E 55/28/21 ²⁾	○	5800	6400		B66335G0000X1**		
	●	0.5	0.5		B66335G0500X1**		
	●	1.0/1.5/2.0	1.0/1.5/2.0		B66335G***X1**		
E 55/28/25	○	6800	7300		B66344G0000X1**		
	●	2.5			B66344G2500X127		
E 56/24/19 ¹⁾	○	6300	6900		B66385G0000X1**		
E 65/32/27	○	7200	7900		B66387G0000X1**		
	●	0.5	0.5		B66387G0500X1**		
	●	1.0/1.5	1.0/1.5		B66387G***X1**		
E 70/33/32	○	8850	9700		B66371G0000X1**		
	●	1.5			B66371G1500X127		
E 80/38/20	○	4150	4500		B66375G0000X1**		
	●	0.5			B66375G0500X127		
Tol. of A _L value A _L -Wert-Toleranz		+30/-20%	+30/-20%	+30/-20%			

● = gapped / mit Luftspalt
○ = ungapped / ohne Luftspalt

*: See ordering code example
Siehe Bestellbeispiel

- 1) Size corresponds to U.S. lam size E cores
Größe entspricht U.S. lam size E cores
E 40/16/12 Δ E 21; E 47/20/16 Δ E 625; E 56/24/19 Δ E 75
- 2) In accordance with IEC 61246

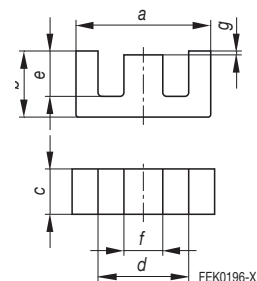

Ordering code Bestellnummer	Magnetic axis Magnetische Achse
B66454A1014T001	horizontal
B66243A1018T001 B66243S1012T001	vertical vertical

Magnetic characteristics (per set) / Magnetische Formkenngrößen (pro Satz)

Type Typ	$\Sigma I/A$ mm ⁻¹	l_e mm	A_e mm ²	A_{min} mm ²	V_e mm ³
E 40/16/12	0.52	77	149	143	11500
E 42/21/15	0.54	97	178	175	17300
E 42/21/20	0.41	97	234	229	22700
E 47/20/16	0.38	89	233	226	20700
E 55/28/21	0.35	124	354	351	43900
E 55/28/25	0.30	124	420	420	52100
E 56/24/19	0.31	107	340	327	36400
E 65/32/27	0.27	147	535	529	78600
E 70/33/32	0.22	149	683	676	102000
E 80/38/20	0.47	184	390	388	71800

Main dimensions (mm) / Hauptmaße (mm)

Type Typ	a	b	c	d	e	f
E 40/16/12	40.6 ±0.6	16.5 ±0.2	12.5 ±0.25	28.6 min	10.5 ±0.3	12.5 +0.25
E 42/21/15	42.0 +1.0/-0.7	21.2 -0.4	15.2 -0.5	29.5 +1.2	14.8 +0.7	12.2 -0.5
E 42/21/20	42.0 +1.0/-0.7	21.2 -0.4	20.0 -0.8	29.5 +1.2	14.8 +0.7	12.2 -0.5
E 47/20/16	46.9 ±0.8	19.6 ±0.2	15.6 ±0.25	31.8 min	12.2 ±0.3	15.6 ±0.25
E 55/28/21	55.0 +1.2/-0.9	27.8 -0.6	21.0 -0.6	37.5 +1.2	18.5 +0.8	17.2 -0.5
E 55/28/25	55.0 +1.2/-0.9	27.8 -0.6	25.0 -0.6	37.5 +1.2	18.5 +0.8	17.2 -0.5
E 56/24/19	56.1 ±1.0	23.6 ±0.23	18.8 ±0.3	38.1 min	14.6 ±0.3	18.8 ±0.3
E 65/32/27	65.0 +1.5/-1.2	32.8 -0.6	27.4 -1.0	44.2 +1.8	22.2 +0.8	20.0 -0.7
E 70/33/32	70.5 ±1.0	33.2 -0.5	32.0 -0.8	48.0 +1.5	21.9 +0.7	22.0 -0.7
E 80/38/20	80.0 ±1.8	38.5 -0.8	20.2 -0.8	58.9 +2.6	27.9 +0.8	20.2 -0.8

Ordering code example / Bestellbeispiel

B66335G1000X127

- Type / Bauform
- Code letter for tolerated air gap / Kennzeichen für tolerierten Luftspalt
- Air gap "dim. g" in thousandths of millimeter (4 digits). "0000" for cores w/o air gap.
Luftspalt „Maß g“ in tausendstel Millimeter (4 Ziffern). „0000“ bei Kernen ohne Luftspalt.
- Filling number / Füllnummer
- Code number for material / Kennziffern für Material

ELP/I Cores

ELP-/I-Kerne

Technical data Technische Daten



Core set Kernset	Clamp recess Klammer- vertiefung	Air gap Luft- spalt	Material (Code number / Kennziffer) A _L values (nH) A _L -Werte (nH)				Ordering code (per piece) Bestellnummer (pro Stück)	
			N49 (49)	N87 (87)	N92 (92)	N97 (97)		
ELP core / ELP-Kern								
EELP 14	without	○	800 ±25%	1100 ±25%	850 ±25%	1150 ±25%	B66281G0000X1**	
EELP 18	with ¹⁾	○	1900 ±25%	2600 ±25%	2025 ±25%	2670 ±25%	B66283G0000X1**	
EELP 22	with ¹⁾	○	3100 ±25%	4500 ±25%	3400 ±25%	4600 ±25%	B66285G0000X1**	
EELP 32	with ¹⁾	○	3900 ±25%	5700 ±25%	4300 ±25%	5700 ±25%	B66287G0000X1**	
EELP 38	with ¹⁾	○	4850 ±25%	7200 ±25%	5400 ±25%	7400 ±25%	B66289G0000X1**	
EELP 43	with ¹⁾	○	5000 ±25%	7300 ±25%	5500 ±25%	7500 ±25%	B66291G0000X1**	
EELP 58	without	○		7400 ±25%			B66293G0000X187	
EELP 64	without	○	8000 ±30%	12500 ±25%			B66295G0000X1**	
ELP core / ELP-Kern I core / I-Kern								
EILP 14	without	○	850 ±25%	1250 ±25%	900 ±25%	1300 ±25%	B66281G0000X1**	B66281P0000X1**
EILP 18	with ¹⁾	○	2100 ±25%	2900 ±25%	2300 ±25%	3000 ±25%	B66283G0000X1**	B66283P0000X1**
EILP 22	with ¹⁾	○	3700 ±25%	5200 ±25%	4000 ±25%	5250 ±25%	B66285G0000X1**	B66285P0000X1**
EILP 32	with ¹⁾	○	4400 ±25%	6300 ±25%	4800 ±25%	6300 ±25%	B66287G0000 X1**	B66287P0000X1**
EILP 38	with ¹⁾	○	5700 ±25%	8300 ±25%	6200 ±25%	8400 ±25%	B66289G0000X1**	B66289P0000X1**
EILP 43	with ¹⁾	○	5900 ±25%	8500 ±25%	6400 ±25%	8700 ±25%	B66291G0000X1**	B66291P0000X1**
EILP 58	without	○		8400 ±25%			B66293G0000X187	B66293P0000X187
EILP 64	without	○	8900 ±30%	14000 ±25%			B66295G0000X1**	B66295P0000X1**

○ = ungapped / ohne Luftspalt

1) = Without clamp recess available. / Ohne Klammervertiefung lieferbar.

** : Code number for material
Kennziffer für Werkstoff

ELP and I cores for extra-low-profile transformer designs

Planar inductive components are taking on increasing importance because they present a number of advantages compared to conventional winding technology, for example

- low profile,
- excellent thermal performance thanks to large core surface,

- high power density,
- high reproducibility.

EPCOS offers matching ferrite cores for this technology. Low-profile E cores (ELP) and I cores are suitable for DC/DC and AC/DC converters for instance. Low-profile core design is specified in IEC 62317-9. ELP and I cores are supplied in single units.

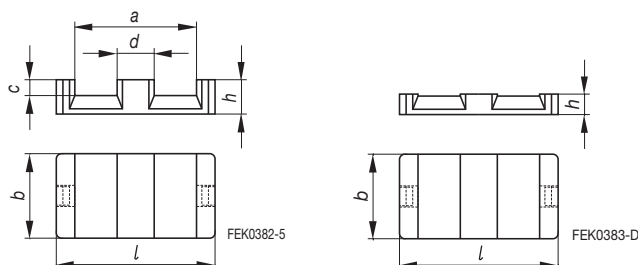
**Accessories
Zubehör
Clamp (2 pieces required)
Klammer (2 Stück erforderlich)**

B65804P2204X000

B65808J2204X000

B66284F2204X000

B65804P2204X000

B66288F2204X000

Magnetic characteristics (per set) / Magnetische Formkenngrößen (pro Satz)

Core set Kernset	Core type Kerntyp	$\Sigma I/A$ mm ⁻¹	l_e mm	A_e mm ²	A_{min} mm ²	V_e mm ³
EELP (ELP + ELP)						
EELP 14	ELP 14/3.5/5	1.45	20.7	14.3	13.9	296
EELP 18	ELP 18/4/10	0.62	24.3	39.3	38.9	955
EELP 22	ELP 22/6/16	0.41	32.5	78.3	77.9	2540
EELP 32	ELP 32/6/20	0.32	41.4	130	128	5390
EELP 38	ELP 38/8/25	0.27	52.4	194	192	10200
EELP 43	ELP 43/10/28	0.27	61.1	229	225	14000
EELP 58	ELP 58/11/38	0.26	80.7	310	308	25000
EELP 64	ELP 64/10/50	0.15	79.9	519	518	41500
EILP (ELP + I)						
EILP 14	I 14/1.5/5 ¹⁾	1.15	16.7	14.5	13.9	242
EILP 18	I 18/2/10 ¹⁾	0.51	20.3	39.5	38.9	802
EILP 22	I 22/2.5/16 ¹⁾	0.33	26.1	78.5	77.9	2050
EILP 32	I 32/3/20 ¹⁾	0.27	35.1	130	128	4560
EILP 38	I 38/4/25 ¹⁾	0.22	43.6	194	192	8440
EILP 43	I 43/4/28 ¹⁾	0.22	50.4	229	225	11500
EILP 58	I 58/4/38 ¹⁾	0.22	67.7	310	308	21000
EILP 64	I 64/5/50 ¹⁾	0.13	69.7	519	518	36200

1) ELP cores see above. / ELP-Kerne siehe oben.

Main dimensions (mm) / Hauptmaße (mm)

Type Typ	l (ELP, I)	b (ELP, I)	h (ELP)	h (I)	a (ELP)	c (ELP)	d (ELP)
ELP 14 / I 14	14.0 ± 0.3	5.0 ± 0.1	3.5 ± 0.1	1.5 ± 0.1	11.0 ± 0.25	2.0 ± 0.1	3.0 ± 0.05
ELP 18 / I 18	18.0 ± 0.35	10.0 ± 0.2	4.0 ± 0.1	2.0 ± 0.1	14.0 ± 0.3	2.0 ± 0.1	4.0 ± 0.1
ELP 22 / I 22	21.8 ± 0.4	15.8 ± 0.3	5.7 ± 0.1	2.5 ± 0.1	16.8 ± 0.4	3.2 ± 0.1	5.0 ± 0.1
ELP 32 / I 32	31.75 ± 0.65	20.35 ± 0.4	6.35 ± 0.15	3.15 ± 0.15	25.4 ± 0.5	3.2 ± 0.15	6.35 ± 0.15
ELP 38 / I 38	38.1 ± 0.8	25.4 ± 0.55	8.25 ± 0.15	3.8 ± 0.15	30.8 ± 0.6	4.45 ± 0.15	7.6 ± 0.2
ELP 43 / I 43	43.2 ± 0.9	27.9 ± 0.6	9.5 ± 0.15	4.1 ± 0.15	35.4 ± 0.7	5.4 ± 0.15	8.1 ± 0.2
ELP 58 / I 58	58.4 ± 1.2	38.1 ± 0.8	10.55 ± 0.15	4.05 ± 0.2	51.1 ± 1.1	6.5 ± 0.15	8.1 ± 0.2
ELP 64 / I 64	64.0 ± 1.3	50.8 ± 1.1	10.2 ± 0.15	5.1 ± 0.15	53.6 ± 1.1	5.1 ± 0.15	10.2 ± 0.2

ELP- und I-Kerne für besonders flache Übertragerbauformen

Planarinduktivitäten gewinnen zunehmend an Bedeutung, da sie gegenüber der herkömmlichen Wickeltechnik eine Reihe von Vorteilen bieten, wie

- geringe Bauhöhe,
- ausgezeichnete thermische Eigenschaften aufgrund der großen Kernoberfläche,

- hohe Leistungsdichte,
- hohe Reproduzierbarkeit.

Für diese Technologie stellt EPCOS entsprechende Ferritkerne bereit. Low-Profil E-Kerne (ELP) und I-Kerne sind z. B. für DC/DC- und AC-/DC-Konverter geeignet. Das Design der Low-Profil-Kerne ist in IEC 62317-9 festgelegt. ELP- und I-Kerne werden stückweise geliefert.

Please read *Cautions and warnings* on page 53 and *Important notes* on page 54.
Bitte beachten Sie die Seite 53 *Warn- und Sicherheitshinweise* sowie
Wichtige Hinweise auf Seite 54.

EQ/I Planar Cores

EQ-/I-Planarkerne

Technical data Technische Daten



Core set Kernset	Air gap Luftspalt	Material (Code number / Kennziffer) A _L values (nH) A _L -Werte (nH)				Ordering code (per piece) Bestellnummer (pro Stück)
		N49 (49)	N87 (87)	N92 (92)	N97 (97)	
Cores / Kerne						EQ core / EQ-Kern
EEQ 13	○	1360 ±25%	1640 ±25%	1320 ±25%	1700 ±25%	B66479G0000X1**
EEQ 20	○	2400 ±25%	3100 ±25%	2450 ±25%	3200 ±25%	B66483G0000X1**
EEQ 25	○	3600 ±25%	4700 ±25%	3650 ±25%	4800 ±25%	B66481G0000X1**
EEQ 30	○	3330 ±25%	4300 ±25%	3270 ±25%	4500 ±25%	B66506G0000X1**
						EQ core / EQ-Kern I core / I-Kern
EIQ 13	○	1600 ±25%	1700 ±25%	1550 ±25%	1800 ±25%	B66479G0000X1** B66479P0000X1**
EIQ 20	○	3000 ±25%	3680 ±25%	2950 ±25%	3770 ±25%	B66483G0000X1** B66483P0000X1**
EIQ 25	○	4200 ±25%	5100 ±25%	4150 ±25%	5300 ±25%	B66481G0000X1** B66481P0000X1**
EIQ 30	○	4350 ±25%	5600 ±25%	4450 ±25%	5750 ±25%	B66506G0000X1** B66506P0000X1**

○ = ungapped / ohne Luftspalt

** : Code number for material
Kennziffer für Werkstoff

EQ/I cores are low profile planar cores with comparatively greater winding area having round center leg. They find applications in high frequencies power conversions with lower losses and higher saturation requirements.

The design is specified in IEC 62217-9.

EQ-/I-Kerne mit rundem Mittelschenkel sind Planarkerne mit vergleichsweise großem Wicklungsbereich. Sie finden Anwendung in Hochfrequenz-Leistungsübertragern mit geringen Verlusten und hoher Sättigung.

Das Design entspricht IEC 62217-9.

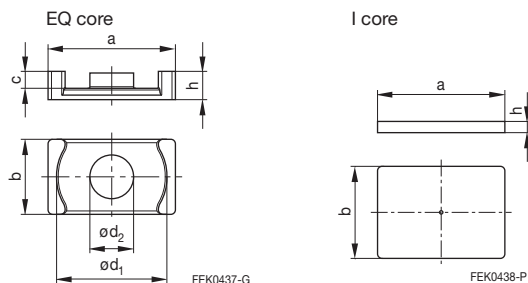
Magnetic characteristics (per set) / Magnetische Formkenngrößen (pro Satz)

Core set Kernset	Core type Kerntyp	$\Sigma l/A$ mm ⁻¹	l_e mm	A_e mm ²	A_{min} mm ²	V_e mm ³
EEQ (EQ + EQ)						
EEQ 13	EQ 13/2.85/9	0.9	17.5	19.8	19.2	347
EEQ 20	EQ 20/6.3/14	0.56	33.2	59.0	55.0	1960
EEQ 25	EQ 25/8/18	0.352	32.95	93.51	86.4	3082
EEQ 30	EQ 30/8/20	0.426	46.0	108.0	95.0	4970
EIQ (EQ + I)						
EIQ 13	I 13/1/9 ¹⁾	0.803	15.9	19.8	19.2	315
EIQ 20	I 20/2.3/14 ¹⁾	0.42	25.1	59.8	55.0	1550
EIQ 25	I 25/2.3/18 ¹⁾	0.294	26.4	89.7	82.8	2370
EIQ 30	I 30/2.7/20 ¹⁾	0.29	31.5	108.0	95.0	3400

1) EQ cores see above. / EQ-Kerne siehe oben.

Main dimensions (mm) / Hauptmaße (mm)

Type Typ	a (EQ, I)	b (EQ, I)	h (EQ)	h (I)	$\varnothing d_1$ (EQ)	$\varnothing d_2$ (EQ)	c (EQ)
EQ 13; I 13	12.8 ±0.3	8.7 ±0.3	2.85 ±0.075	1.1 ±0.1	11.2 ±0.3	5.0 ±0.15	1.75 ±0.125
EQ 20; I 20	20.0 ±0.35	14.0 ±0.3	6.3 ±0.1	2.3 ±0.05	18.0 ±0.35	8.8 ±0.15	4.1 ±0.15
EQ 25; I 25	25.0 ±0.4	18.0 ±0.3	5.6 ±0.05	2.3 ±0.05	22.0 ±0.4	11.0 ±0.2	3.2 ±0.15
EQ 30; I 30	30.0 ±0.4	20.0 ±0.3	8.0 ±0.15	2.7 ±0.1	26.0 ±0.4	11.0 ±0.2	5.3 ±0.2

ER/I Planar Cores

ER-/I-Planarkerne

Technical data Technische Daten



Core set Kernset	Air gap Luftspalt	Material (Code number / Kennziffer) AL values (nH) / tolerance code ¹⁾ AL-Werte (nH) / Toleranzbuchstabe ¹⁾					Ordering code (per set) Bestellnummer (pro Satz)	Coil formers Spulenkörper			
		T38 (38)	N49 (49)	N87 (87)	N92 (92)	N97 (97)		Sect. Kamm.	Pins Stifte	Ordering code Bestellnummer	
Cores / Kerne							Accessories / Zubehör				
ER 9.5/5	○	4500	Y				B65523J0000Y038	1	SMD	8	B65527B1008T001
	○				800	R	B65523J0000R087	1	SMD	8	B65527C1008D001
ER 11/5	○	6400	Y				B65525J0000Y038	1	SMD	10	B65526B1010T001
	○			800	R		B65525J0000R049	1	SMD	10	B65526C1010D001
	○				1200	R	B65525J0000R087				
	●				160	±3%	B65525J0160A087				
ER 14.5/6	○			1100	R	1500	R	1500	R		B65514B1010D001
	○						B65513J0000R0**	1		10	B65514C1010T001

Core set Kernset	Air gap Luftspalt	Material (Code number / Kennziffer) AL values (nH) AL-Werte (nH)				Ordering code (per piece) Bestellnummer (pro Stück)	
		N49 (49)	N87 (87)	N92 (92)	N97 (97)		
ER core / ER-Kern							
EER 18	○	1800 ±25%	2300 ±25%	1800 ±25%	2300 ±25%	B66480G0000X1**	
EER 23	○	2200 ±25%	3000 ±25%	2200 ±25%	3000 ±25%	B66482G0000X1**	
EER 25	○	3000 ±25%	4100 ±25%	3000 ±25%	4100 ±25%	B66484G0000X1**	
EER 32	○	3800 ±25%	4900 ±25%	3800 ±25%	5000 ±25%	B66501G0000X1**	
ER core / ER-Kern I core / I-Kern							
EIR 23	○	2600 ±25%	3400 ±25%	2600 ±25%	3400 ±25%	B66482G0000X1**	B66482P0000X1**
EIR 25	○	3400 ±25%	4600 ±25%	3400 ±25%	4600 ±25%	B66484G0000X1**	B66484P0000X1**

- = gapped / mit Luftspalt
- = ungapped / ohne Luftspalt

1) = Code for AL tolerance:
Kennbuchstabe für AL-Toleranz:
R Δ +30/-20%; Y Δ +40/-30%

ER planar cores are in accordance with IEC 62317-9.
ER-Planarkerne entsprechen IEC 62317-9.

** : Code number for material
Kennziffer für Werkstoff

ER cores with round center leg

ER 9.5 and ER 11/5 are especially suitable for transformer designs with low total height and high inductance. Also available are accessories for surface mounting.

ER 9.5 ... ER 14.5 are supplied in sets.
ER 18 ... ER 32 are supplied in pieces.

ER-Kerne mit rundem Mittelschenkel

ER 9.5 and ER 11/5 eignen sich besonders für den Aufbau von Übertragern mit niedriger Bauhöhe und hoher Induktivität. Hier steht auch ein Zubehör für Oberflächenmontage zur Verfügung.

ER 9.5 ... ER 14.5 werden satzweise geliefert.
ER 18 ... ER 32 werden stückweise geliefert.

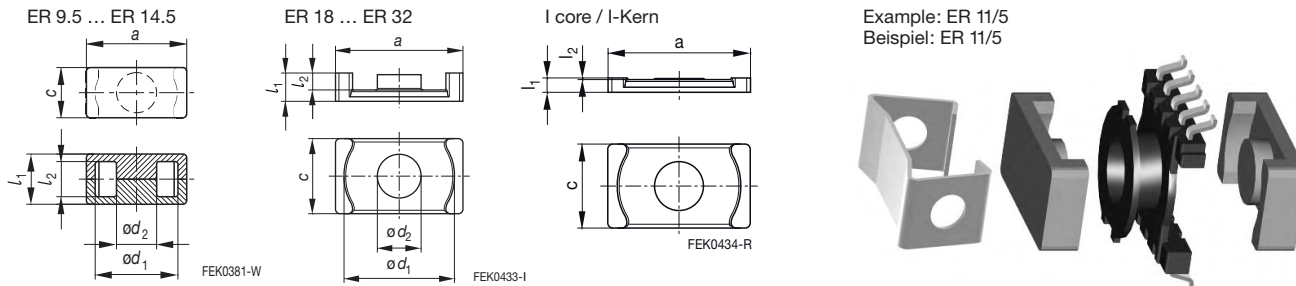

Yoke Bügel	
Features Merkmale	
Gullwing terminals	B65527A2000X000
Gullwing terminals	B65526A2000X000
Gullwing terminals	B65514A2000X000

Magnetic characteristics (per set) / Magnetische Formkenngrößen (pro Satz)

Core set Kernset	Core type Kerntyp	$\Sigma I/A$ mm ⁻¹	l_e mm	A_e mm ²	A_{min} mm ²	V_e mm ³
ER 9.5/5	–	1.54	13.6	8.81	–	120
ER 11/5	–	1.10	14.1	12.4	–	174
ER 14.5/6	–	1.10	19.0	17.6	–	333

ER + ER

EER 18	ER 18/3/10	0.732	22.1	30.2	30.1	667
EER 23	ER 23/5/13	0.648	32.6	50.3	50.0	1640
EER 25	ER 25/6/15	0.482	34.1	70.8	69.4	2414
EER 32/5/21	ER 32/5/21	0.346	38.0	109.8	98.5	4172

ER + I

ER 23 / I 23	I 23/2/13 ¹⁾	0.53	26.6	50.3	50.0	1335
ER 25 / I 25	I 25/3/15 ¹⁾	0.399	28.1	70.4	69.4	1978

1) ER cores see above. / ER-Kerne siehe oben.

Main dimensions (mm) / Hauptmaße (mm)

Type Typ	a	c	d ₁	d ₂	h ₁	h ₂
ER 9.5/5	9.5 –0.3	5 –0.2	7.5 +0.25	3.5 –0.2	5 –0.2	3.2 +0.3
ER 11/5	11 –0.35	6 –0.2	8.7 +0.3	4.25 –0.2	5 –0.2	3.0 +0.3
ER 14.5/6	14.5 ±0.2	6.7 ±0.1	11.8 ±0.2	4.7 ±0.1	5.9 ±0.1	3.3 ±0.2
ER 18	18 ±0.35	9.7 ±0.2	15.6 ±0.3	6.2 ±0.15	3.15 ±0.1	1.6 ±0.1
ER 23	23.2 ±0.45	12.5 ±0.25	20.2 ±0.4	8.0 ±0.2	5.1 ±0.1	3.1 ±0.1
I 23					2.1 ±0.1	0.2 max.
ER 25	25 ±0.5	14.8 ±0.3	21.7 ±0.4	9.4 ±0.2	5.5 ±0.1	3.1 ±0.1
I 25					2.5 ±0.1	0.2 max.
ER 32	32 ±0.6	21.0 ±0.4	29.7 ±0.5	11.2 ±0.2	5.1 ±0.1	2.7 ±0.1

ER Cores

ER-Kerne

Technical data Technische Daten

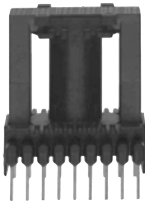

Type Typ	Air gap Luft- spalt	Material A _L values (nH) or dim. g (mm) for cores with air gap A _L -Werte (nH) bzw. Maß g (mm) für Kerne mit Luftspalt			Ordering code (per piece) Bestellnummer (pro Stück)	Coil formers Spulenkörper	
		N27	N72	N87		Sections / Pins Kammern / Stifte	Accessories / Zubehör
Cores / Kerne						Accessories / Zubehör	
ER 28/17/11	○		2700 +30/-20 %		B66433G0000X172		
ER 35/20/11	○	2500 +30/-20 %			B66350G0000X127	1/18	
	○			2700 +30/-20 %	B66350G0000X187		
	●	0.5 ±0.05			B66350G0500X127		
	●	1.0 ±0.05			B66350G1000X127		
ER 42/22/15	●	1.5 ±0.05			B66350G1500X127		
	○	3200 +30/-20 %			B66347G0000X127		
	○			3700 +30/-20 %	B66347G0000X187		
ER 46/17/18	●	1.0 ±0.05			B66347G1000X127		
	○	5700 +30/-20 %			B66377G0000X127		
ER 49/27/17	●	1.0 ±0.05			B66377G1000X127		
	○	3500 +30/-20 %			B66391G0000X127		
ER 54/18/18	○	5600 +30/-20 %			B66357G0000X127		
	○			5800 +30/-20 %	B66357G0000X187		
	●	0.5 ±0.05			B66357G0500X127		

- = gapped / mit Luftspalt
- = ungapped / ohne Luftspalt

ER cores with round center leg

ER cores are the ideal answer when compact winding structures with low leakage inductance are needed. The round center leg is an advantage together with thick wires or bands. This kind of core is used in flyback converters for TVs and monitors.

ER 28 through ER 54 are supplied in single units.

ER-Kerne mit rundem Mittelschenkel

ER-Kerne sind ideal, wenn kompakte Wickelaufbauten mit kleiner Streuinduktivität gefordert werden. Der runde Mittelschenkel ist vorteilhaft bei Verwendung dicker Drähte oder Bänder. Diese Kernform findet Anwendung in Sperrwandlern (Flyback) bei TV und Monitoren.

ER 28 bis ER 54 werden stückweise geliefert.

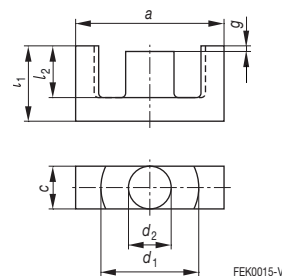
Magnetic characteristics (per set) / Magnetische Formkenngrößen (pro Satz)

Type Typ	$\Sigma I/A$ mm ⁻¹	I_e mm	A_e mm ²	A_{min} mm ²	V_e mm ³
ER 28	0.88	75.0	85.4	77.0	6400
ER 35	0.81	89.6	111	101	9930
ER 42	0.58	99	170	170	16800
ER 46	0.34	79	233	226	18400
ER 49	0.49	118	243	225	28700
ER 54	0.35	90	256	252	23000

Main dimensions (mm) / Hauptmaße (mm)

Type Typ	a	c	$\varnothing d_1$	$\varnothing d_2$	l_1	l_2
ER 28	28.55 ±0.55	11.4 ±0.25	21.75 ±0.5	9.9 ±0.25	16.9 ±0.2	12.6 ±0.3
ER 35	35 ±0.6	11.3 ±0.2	25.6 min	11.3 +0.2/-0.25	20.7 ±0.3	14.7 ±0.3
ER 42	42 +1/-0.7	15.0 -0.6	30.4 +1.2	15.0 -0.6	21.8 -0.4	15.6 +0.7
ER 46	46 -2	18.0 -0.8	33.0 +1.6	18.0 -0.8	17.5 -0.4	10.5 +0.5
ER 49	49 ±1	17.2 ±0.4	37.3 ±0.9	17.2 ±0.4	27.0 ±0.3	18.5 ±0.4
ER 54	53.5 ±1	18.3 -0.7	39.8 +1.7	18.3 -0.8	18.5 -0.4	10.8 +0.6

PQ Cores

PQ-Kerne

Technical data Technische Daten



Type Typ	Material A _L values (nH), tolerance +30/-20% A _L -Werte (nH), Toleranz +30/-20%					Ordering code (per set) Bestellnummer (pro Satz)	Coil formers Spulenkörper	
	N87	N97	N49	N95	N92		Sections Kammern	Pins Stifte
Cores / Kerne (ungapped / ohne Luftspalt)							Accessories / Zubehör	
PQ 16/11.6	2350					B65885A0000R087		
		2450				B65885A0000R097		
			1900			B65885A0000R049		
				2750		B65885A0000R095		
PQ 20/16	3100					B65885A0000R092		
		3200				B65875B0000R087	1	14
			2400			B65875B0000R097		
				3750		B65875B0000R049		
PQ 20/20	2650					B65875B0000R095		
		2750				B65875B0000R092		
			2000			B65875A0000R087	1	14
				3300		B65875A0000R097		
PQ 26/20	5000					B65875A0000R049		
		5150				B65875A0000R095		
			3850			B65877B0000R087	1	12
				6300		B65877B0000R097		
PQ 26/25	4500					B65877B0000R049		
		4650				B65877B0000R095		
			3300			B65877A0000R087	1	12
				5700		B65877A0000R097		
PQ 32/20	6300					B65877A0000R049		
		6500				B65877A0000R095		
			4600			B65879A0000R087	1	12
				7600		B65879A0000R097		
PQ 32/30	4800					B65879A0000R049		
		5000				B65879A0000R095		
			3450			B65879B0000R087	1	12
				6100		B65879B0000R097		
PQ 35/35	4500					B65879B0000R049		
		4700				B65879B0000R095		
			3300			B65881A0000R087	1	4
				5700		B65881A0000R097		
					B65881A0000R049			
					B65881A0000R095			
					B65881A0000R092			

PQ cores for switch-mode power supplies

These cores are a preferred shape for power conversion. The main advantages compared to the conventional round/rectangular E type cores are its optimized round leg and wider outer surface. The round leg reduces winding

length and hence copper cost in the manufacturing and the wider surface area lowers the thermal resistance by offering a larger area for heat dissipation. The shape also provides better shielding to the winding.

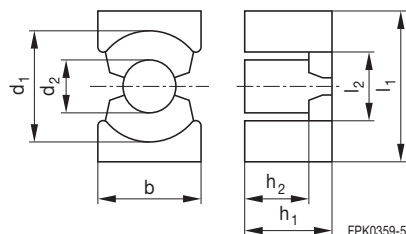

FPK0359-5

Magnetic characteristics (per set) / Magnetische Formkenngrößen (pro Satz)

Type Typ	$\Sigma I/A$ mm ⁻¹	l_e mm	A_e mm ²	A_{min} mm ²	V_e mm ³
PQ 16/11.6	0.641	27.0	42.1	38.5	1136
PQ 20/16	0.579	37.0	64.0	57.6	2367
PQ 20/20	0.718	45.2	62.9	54.4	2843
PQ 26/20	0.363	44.4	122.3	108.8	5435
PQ 26/25	0.440	53.6	122.0	108.7	6530
PQ 32/20	0.314	48.4	154.2	127.5	7460
PQ 32/30	0.441	67.8	153.8	127.5	10440
PQ 35/35	0.467	79.2	169.7	146.5	13440

Main dimensions (mm) / Hauptmaße (mm)

Type Typ	l_1	l_2	b	h_1	h_2	$\varnothing d_1$	$\varnothing d_2$
PQ 16/11.6	16.4 ±0.3	9.6 +0.8	11.2 ±0.3	5.8 ±0.1	3.35 ±0.15	14.4 ±0.3	7 ±0.2
PQ 20/16	20.5 ±0.4	12.5 min.	14.0 ±0.4	8.1 ±0.1	5.15 ±0.15	18.0 ±0.4	8.8 ±0.2
PQ 20/20	20.5 ±0.4	12.5 min.	14.0 ±0.4	10.1 ±0.1	7.15 ±0.15	18.0 ±0.4	8.8 ±0.2
PQ 26/20	26.5 ±0.45	15.5 +0.8	19.0 ±0.45	10.08 ±0.12	5.75 ±0.15	22.5 ±0.45	12.0 ±0.2
PQ 26/25	26.5 ±0.45	15.5 +0.8	19.0 ±0.45	12.38 ±0.12	8.05 ±0.15	22.5 ±0.45	12.0 ±0.2
PQ 32/20	32.0 ±0.5	19.0 +0.8	22.0 ±0.5	10.25 +0.15/-0.1	5.75 ±0.15	27.5 ±0.5	13.45 ±0.25
PQ 32/30	32.0 ±0.5	19.0 +0.8	22.0 ±0.5	15.175 ±0.125	10.65 ±0.15	27.5 ±0.5	13.45 ±0.25
PQ 35/35	35.1 ±0.6	23.5 min.	26.0 ±0.5	17.4 +0.1/-0.15	12.50 ±0.15	32.0 ±0.5	14.35 ±0.25

PQ-Kerne für Schaltnetzteile

PQ-Kerne werden bevorzugt zur Energieumwandlung eingesetzt. Der Hauptvorteil gegenüber den konventionellen ETD-/ER- und E-Baureihen ist der stabile runde Schenkel und die breitere Außenfläche. Der runde Schen-

kel minimiert den Kupferverbrauch bei der Wicklung und reduziert damit Kosten. Die größeren Außenflächen erleichtern die Wärmeableitung. Diese Kernform bietet auch eine gute Abschirmung der Wicklung.

ETD Cores

ETD-Kerne

Technical data Technische Daten



Type Typ	Air gap Luft- spalt	Material (Code number / Kennziffer) A _L values (nH) ¹⁾ or dim. g (mm) for cores with air gap A _L -Werte (nH) ¹⁾ bzw. Maß g (mm) für Kerne mit Luftspalt			Ordering code (per piece) Bestellnummer (pro Stück)	Coil formers Spulenkörper			
		N27 (27)	N87 (87)	N97 (97)		Sections Kammern	Pins Stifte	Ordering code Bestellnummer	
Cores / Kerne						Accessories / Zubehör			
ETD 29/16/10	○	2000	2200	2250	B66358G0000X1**	1	13	B66359B1013T001	
	●	0.1/0.2/0.5	0.1/0.2/0.5		B66358G0***X1**	1	13	B66359A1013T001	
	●	1.0	1.0		B66358G1000X1**	1	13	B66359W1013T001	
ETD 34/17/11	○	2400	2600	2650	B66361G0000X1**	1	14	B66362B1014T001	
	●	0.1/0.2/0.5	0.1/0.2/0.5		B66361G0***X1**	1	14	B66362W1014T001	
	●	1.0	1.0		B66361G0000X1**	1	14	B66362X1014T001	
ETD 39/20/13	○	2550	2700	2800	B66363G0000X1**	1	16	B66364B1016T001	
	●	0.1/0.2/0.5	0.1/0.2/0.5		B66363G0***X1**	1	16	B66364W1016T001	
	●	1.0	1.0		B66363G1000X1**				
ETD 44/22/15	○	3300	3500	3600	B66365G0000X1**	1	18	B66366B1018T001	
	●	0.2/0.5	0.2/0.5		B66365G0***X1**	1	18	B66366W1018T001	
	●	1.0/1.5	1.0/1.5		B66365G***X1**				
ETD 49/25/16	○	3700	3800	3900	B66367G0000X1**	1	20	B66368B1020T001	
	●	0.2/0.5	0.2/0.5		B66367G0***X1**	1	20	B66368W1020T001	
	●	1.0/2.0	1.0/2.0		B66367G***X1**				
ETD 54/28/19	○	4200	4450	4600	B66395G0000X1**	1	22	B66396W1022T001	
	●	0.2	0.2		B66395G0200X1**				
	●	1.0/1.5/2.0	1.0/1.5/2.0		B66395G***X1**				
ETD 59/31/22	○	5000	5300	5500	B66397G0000X1**	1	24	B66398W1024T001	
	●	0.2	0.2		B66397G0200X1**				
	●	1.0/1.5/2.0	1.0/1.5/2.0		B66397G***X1**				

● = gapped / mit Luftspalt
○ = ungapped / ohne Luftspalt

1) Tolerance of A_L value: +30/-20%
A_L-Wert-Toleranz: +30/-20%

*: See ordering code example
Siehe Bestellbeispiel

ETD cores to IEC 61185 (Economic Transformer Design)

ETD cores are an excellent solution for designing switch-mode power supply transformers with optimum power/weight ratio for low volume. The round center leg is an

advantage together with thick wires or bands. ETD cores are characterized by an wide opening for winding. Optimized accessories are available. ETD cores are in accordance with IEC 61185. They are supplied in single units.

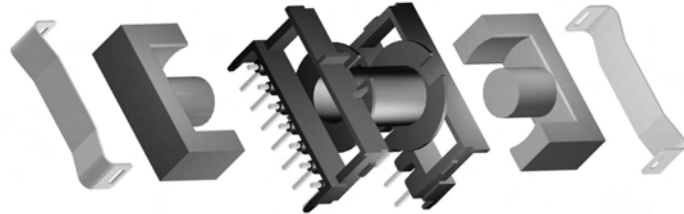
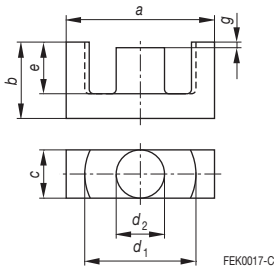

FEK0017-C

	Yokes (2 pieces required) Bügel (2 Stück erforderlich)
Magnetic axis (material) Magn. Achse (Material)	
horizontal (Valox 420 SE0) horizontal (Valox 420 SE0) horizontal (Rynite FR 530) vertical (Rynite FR 530)	B66359A2000X000
horizontal (Valox 420 SE0) horizontal (Rynite FR 530) vertical (Rynite FR 530)	B66362A2000X000
horizontal (Valox 420 SE0) horizontal (Rynite FR 530)	B66364A2000X000
horizontal (Valox 420 SE0) horizontal (Rynite FR 530)	B66366A2000X000
horizontal (Valox 420 SE0) horizontal (Rynite FR 530)	B66368A2000X000
horizontal (Rynite FR 530)	B66396A2000X000
horizontal (Rynite FR 530)	B66398A2000X000

Magnetic characteristics (per set) / Magnetische Formkenngrößen (pro Satz)

Type Typ	$\Sigma I/A$ mm ⁻¹	l_e mm	A_e mm ²	A_{min} mm ²	V_e mm ³
ETD 29	0.93	70.4	76.0	71.0	5350
ETD 34	0.81	78.6	97.1	91.6	7630
ETD 39	0.74	92.2	125	123	11500
ETD 44	0.60	103	173	172	17800
ETD 49	0.54	114	211	209	24100
ETD 54	0.45	127	280	280	35600
ETD 59	0.38	139	368	368	51200

Main dimensions (mm) / Hauptmaße (mm)

Type Typ	a	b	c	d ₁	d ₂	e
ETD 29	30.6 -1.6	16.0 -0.4	9.8 -0.6	22.0 +1.4	9.8 -0.6	10.7 +0.6
ETD 34	34.0 +1/-0.6	17.5 -0.4	11.1 -0.6	25.6 +1.4	11.1 -0.6	11.8 +0.6
ETD 39	38.9 +1.1/-0.7	20.0 -0.4	12.8 -0.6	29.3 +1.6	12.8 -0.6	14.2 +0.8
ETD 44	43.8 +1.2/-0.8	22.5 -0.4	15.2 -0.8	32.5 +1.6	15.2 -0.8	16.1 +0.8
ETD 49	48.5 +1.3/-0.9	24.9 -0.4	16.7 -0.8	36.1 +1.8	16.7 -0.8	17.7 +0.8
ETD 54	54.5 ±1.3	27.8 -0.4	19.3 -0.8	40.1 +2.2	19.3 -0.8	19.8 +0.8
ETD 59	59.8 ±1.4	31.2 -0.4	22.1 -0.9	43.6 +2.2	22.1 -0.9	22.0 +0.9

Ordering code example / Bestellbeispiel
B66358G1000X127

- Type / Bauform
- Code letter for tolerated air gap / Kennzeichen für tolerierten Luftspalt
- Air gap "dim. g" in thousandths of millimeter (4 digits). "0000" for cores w/o air gap.
Luftspalt „Maß g“ in tausendstel Millimeter (4 Ziffern). „0000“ bei Kernen ohne Luftspalt.
- Filling number / Füllnummer
- Code number for material / Kennziffern für Material

**ETD-Kerne nach IEC 61185
(Economic Transformer Design)**

ETD-Kerne eignen sich hervorragend für den Aufbau von Schaltnetzteilübertragern mit optimaler gewichtsbezogener Leistung bei kleinem Volumen. Der runde Mittel-

schenkel ist vorteilhaft bei Verwendung dicker Drähte oder Bänder. ETD-Kerne zeichnen sich durch einen besonders großen Wickelraum aus. Es steht ein optimiertes Zubehör zur Verfügung. ETD-Kerne entsprechen IEC 61185. Sie werden stückweise geliefert.

EFD/EV Cores

EFD-/EV-Kerne

Technical data Technische Daten



Type Typ	Air gap Luft- spalt	Material (Code number / Kennziffer) A _L values (nH) A _L -Werte (nH)				Ordering code (per piece) Bestellnummer (pro Stück)	Coil formers ¹⁾ Spulenkörper ¹⁾	
		N27 (27)	N49 (49)	N87 (87)	N97 (97)		Sections Kammern	Pins Stifte
EFD 10	○		370 +30/-20%	450 +30/-20%	470 +30/-20%	B66411G0000X1**		
EFD 15	○		600 +30/-20%	780 +30/-20%	820 +30/-20%	B66413G0000X1**		1 8
	●			100 ±10%		B66413U0100K187	SMD	1 8
	●			160 ±15%		B66413U0160L187		
EFD 20	○		910 +30/-20%	1200 +30/-20%	1250 +30/-20%	B66417G0000X1**		1 8
	●			100 ±10%		B66417U0100K187	SMD	1 8
	●			160 ±10%		B66417U0160K187		
EFD 25	○			2000 +30/-20%	2100 +30/-20%	B66421G0000X1**		1 10
	●			160 ±10%		B66421U0160K187	SMD	1 10
	●			250 ±10%		B66421U0250K187		
	●			315 ±10%		B66421U0315K187		
EFD 30	○			2050 +30/-20%	2150 +30/-20%	B66423G0000X1**		1 12
	●			160 ±10%		B66423U0160K187	SMD	1 13
	●			250 ±10%		B66423U0250K187		
	●			315 ±10%		B66423U0315K187		
							Accessories / Zubehör	
EV 15/9/7	○	1150 ±25%		1250 ±25%	1300 ±25%	B66434G0000X1**	SMD	1 12
EV 25/13/13	○	2400 +30/-20%		2500 +30/-20%	2600 +30/-20%	B66408G0000X1**		
EV 30/16/13	○	2600 +30/-20%		2800 +30/-20%	2900 +30/-20%	B66432G0000X1**		

- = gapped / mit Luftspalt
- = ungapped / ohne Luftspalt

** : Code number for material
Kennziffer für Werkstoff

1) Pin versions for EFD coil formers upon request.
Stiftvarianten für EFD-Spulenkörper auf Anfrage.

E cores for extra-low-profile transformer designs

EFD and EV cores are optimized in cross-section and feature a flattened, lowered center leg. That allows implementation of very flat, compact transformers for RF

applications. EFD and EV cores are used for DC/DC converters, EV cores are additionally suitable for storage chokes and EMI suppression chokes.

These cores are supplied in single units.

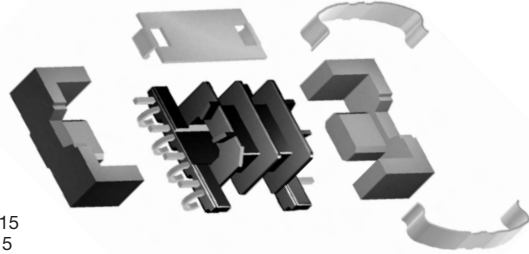

Example: EFD 15
Beispiel: EFD 15

Ordering code Bestellnummer	Features Merkmale	Yokes (2 pieces required) Bügel (2 Stck. erforderl.)
B66414W1008D001	PTH / Stifte	B66414B2000X000
B66414B6008T001	J terminals	B66414B2000X000 B66414A7000X000 (Cover plate / Abdeckplatte)
B66418W1008D001	PTH / Stifte	B66418B2000X000
B66422W1010D001	PTH / Stifte	B66422B2000X000
B66424W1012D001 B66424C1013D001	PTH / Stifte PTH / Stifte	B66424B2000X000
B66456A1012T001	U terminals	

Magnetic characteristics (per set) / Magnetische Formkenngrößen (pro Satz)

Type Typ	$\Sigma I/A$ mm ⁻¹	l_e mm	A_e mm ²	A_{min} mm ²	V_e mm ³
EFD 10	3.21	23.1	7.2	6.5	166
EFD 15	2.27	34	15	12.2	510
EFD 20	1.52	47	31	31	1460
EFD 25	0.98	57	58	57	3310
EFD 30	0.99	68	69	69	4690
EV 15	1.4	38.7	27.7	25.8	1070
EV 25	0.8	59	74	73	4370
EV 30	0.76	74.8	99	95	7410

Main dimensions (mm) / Hauptmaße (mm)

Type Typ	a	b	c	d ₁	d ₂	e	f
EFD 10	10.5 ±0.3	5.2 ±0.1	2.7 ±0.1	7.65 ±0.25	4.55 ±0.15	3.75 ±0.15	1.45 ±0.05
EFD 15	15.0 ±0.4	7.5 ±0.15	4.65 ±0.15	11.0 ±0.35	5.3 ±0.15	5.5 ±0.25	2.4 ±0.10
EFD 20	20.0 ±0.55	10.0 ±0.15	6.65 ±0.15	15.4 ±0.5	8.9 ±0.2	7.7 ±0.25	3.6 ±0.15
EFD 25	25.0 ±0.65	12.5 ±0.15	9.1 ±0.2	18.7 ±0.6	11.4 ±0.2	9.3 ±0.25	5.2 ±0.15
EFD 30	30.0 ±0.8	15.0 ±0.15	9.1 ±0.2	22.4 ±0.75	14.6 ±0.25	11.2 ±0.3	4.9 ±0.15
EV 15	14.8 +0.7/-0.5	9.0 -0.3	7.0 -0.4	10.8 ±0.6	5.8 -0.4	6.0 +0.4	4.8 -0.4
EV 30	29.7 ±0.8	16.4 ±0.3	12.5 ±0.4	22.1 ±0.5	11.6 ±0.3	11.9 ±0.3	8.2 ±0.3

EFD

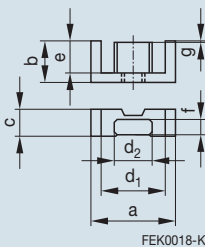

EV 15; 30

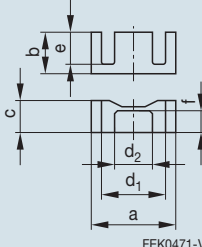

EV 25

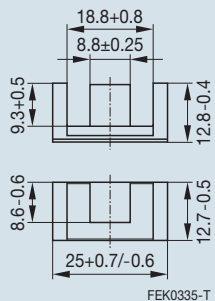

E-Kerne für besonders flache Übertrager-Bauformen

Die querschnittsoptimierten EFD- und EV-Kerne besitzen einen abgeflachten, tiefer gelegten Mittelschenkel. Damit lassen sich sehr flache und kompakte Trafos für hoch-

frequente Anwendungen realisieren. EFD- und EV-Kerne werden für DC/DC-Konverter verwendet, EV-Kerne sind auch für Speicher- und Entstördrosseln geeignet.

Alle Kerne werden stückweise geliefert.

Toroids R 2.5 ... R 20

Ringkerne R 2.5 ... R 20

Technical data Technische Daten



Type / Typ Toroid size (d _o x d _i x h) Ringkerngröße (d _o x d _i x h) (Outer diameter x inner diameter x height) mm		Material (Code number for ord. code, Block 3) / Werkstoff (Kennziffer für Bestellnr. Block 3) A _L values (nH) / approx. initial permeability μ _i / A _L -Werte (nH) / Anfangspermeabilität μ _i											
		K10 (X010)		N30 (X830)		T57 (X057)		T65 (X065)		T35 (X035)		T37 (X037)	
		A _L	μ _i	A _L	μ _i	A _L	μ _i	A _L	μ _i	A _L	μ _i	A _L	μ _i
R 2.50 x 1.50 x 1.00	R 0.098 x 0.059 x 0.039	70	700			410	4000	470	4600				
R 2.54 x 1.27 x 1.27	R 0.100 x 0.050 x 0.050	120	700			690	3900	800	4500				
R 3.05 x 1.27 x 1.27	R 0.120 x 0.050 x 0.050	160	700			830	3700	1000	4500				
R 3.05 x 1.27 x 2.54	R 0.120 x 0.050 x 0.100	330	700			1700	3800	2000	4500				
R 3.05 x 1.78 x 2.03	R 0.120 x 0.070 x 0.080	160	700			870	4000	1000	4600				
R 3.43 x 1.78 x 1.78	R 0.135 x 0.070 x 0.070	160	700			930	4000	1050	4500				
R 3.43 x 1.78 x 2.03	R 0.135 x 0.070 x 0.080	190	700			1060	4000	1200	4500				
R 3.43 x 1.78 x 2.11	R 0.135 x 0.070 x 0.083	200	700			1100	4000	1300	4700				
R 3.94 x 1.78 x 1.78	R 0.155 x 0.070 x 0.070	200	700			1100	3900	1350	4800				
R 3.94 x 2.24 x 1.30	R 0.155 x 0.088 x 0.051	100	700			550	3800	700	4800				
R 4.00 x 2.40 x 1.60	R 0.157 x 0.094 x 0.063			700	4300			750	4600				
R 5.84 x 3.05 x 3.00	R 0.230 x 0.120 x 0.118			1680	4300			1800	4600				
R 6.30 x 3.80 x 2.50	R 0.248 x 0.150 x 0.098			1090	4300			1160	4600				
R 8.00 x 4.00 x 4.00	R 0.315 x 0.158 x 0.158			2400	4300			2550	4600				
R 9.53 x 4.75 x 3.17	R 0.375 x 0.187 x 0.125			1900	4300			2050	4600	2650	6000		
R 10.0 x 6.00 x 4.00	R 0.394 x 0.236 x 0.157			1760	4300			1900	4700	2460	6000	2660	6500
R 12.5 x 7.50 x 5.00	R 0.492 x 0.295 x 0.197			2200	4300			2400	4700	3060	6000	3320	6500
R 12.7 x 7.90 x 6.35	R 0.500 x 0.311 x 0.250			2600	4300			2850	4700	3620	6000	3920	6500
R 13.3 x 8.30 x 5.00	R 0.524 x 0.327 x 0.197			2030	4300			2300	4900	2830	6000	3060	6500
R 14.0 x 9.00 x 5.00	R 0.551 x 0.354 x 0.197			1900	4300			2300	5200	2650	6000	2880	6500
R 15.0 x 10.4 x 5.30	R 0.591 x 0.409 x 0.209			1670	4300			2020	5200	2330	6000	2520	6500
R 15.8 x 8.90 x 4.70	R 0.622 x 0.350 x 0.185			2320	4300			2800	5200	3240	6000	3500	6500
R 16.0 x 9.60 x 6.30	R 0.630 x 0.378 x 0.248			2770	4300			3350	5200	3870	6000	4190	6500
R 17.0 x 10.7 x 6.80	R 0.669 x 0.421 x 0.268			2710	4300			3250	5200	3770	6000	4080	6500
R 18.4 x 5.90 x 5.90	R 0.724 x 0.232 x 0.232			5770	4300			6680	5000	8020	6000	8690	6500
R 20.0 x 10.0 x 7.00	R 0.787 x 0.394 x 0.276			4160	4300			5050	5200	5000	5100	6280	6500
Tolerance of A _L value / A _L -Wert-Toleranz		± 25%		± 25%		± 25%		± 30%		± 25%		± 25%	

Toroidal cores for EMC and LAN applications

Toroidal cores are primarily used as EMC chokes for suppressing RF interference in the MHz region and in signal transformers.

Typical applications for toroids of NiZn ferrites are LAN chokes. One of the materials available for this purpose is K10; other materials upon request.

High-permeability MnZn materials for interference suppression:

- R 2.5 through R 12.5 for telecommunications, e.g. ISDN (N30, T38, T46)
- R 2.5 through R 3.94 for LAN (T57)
- R 13.3 through R 25.3 for power line chokes (N30, T65, T35 to T46)
- > R 34 for chokes and filters in industrial use (T65)

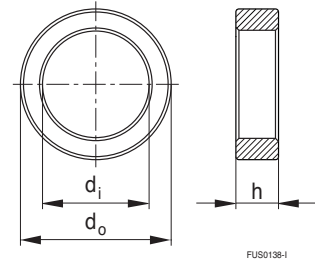

FUS0138-I

						Ordering code Bestellnummer			Magnetic characteristics Magnetische Formkenngrößen				Approx. weight Ca. Gewicht
T38 (X038)		T46 (X046)		N87 (X087)		Block 1	Block 2	Block 3	$\Sigma l/A$ mm ⁻¹	l_e mm	A_e mm ²	V_e mm ³	g
A_L	μ_i	A_L	μ_i	A_L	μ_i								
1020	10000	1530	15000			B64290	P0035	X***	12.30	6.02	0.49	3.0	0.02
1760	10000	2640	15000			B64290	P0734	X***	7.14	5.53	0.77	4.29	0.03
2200	9900	3340	15000			B64290	P0683	X***	5.65	5.99	1.06	6.4	0.04
4200	9400	6500	15000			B64290	P0739	X***	2.82	5.99	2.12	12.7	0.08
2150	9900	3250	15000			B64290	P0733	X***	5.75	7.23	1.26	9.1	0.06
2300	10000	3400	15000			B64290	P0731	X***	5.38	7.63	1.42	10.7	0.06
2650	10000	4000	15000			B64290	P0745	X***	4.72	7.63	1.62	12.2	0.07
2770	10000	4000	15000			B64290	P0709	X***	4.54	7.63	1.68	12.7	0.07
2830	10000	4200	15000			B64290	P0732	X***	4.44	8.10	1.82	14.8	0.08
1470	10000	2200	15000			B64290	P0061	X***	8.56	9.21	1.08	9.9	0.05
1630	10000	2450	15000			B64290	P0036	X***	7.96	9.63	1.25	12.0	0.05
3900	10000	5850	15000			B64290	P0687	X***	3.22	13.03	4.04	52.6	0.3
2530	10000	3600	14000	560	2200	B64290	P0037	X***	4.97	15.21	3.06	46.5	0.2
5500	10000	8000	15000	1200	2200	B64290	P0751	X***	2.26	17.42	7.70	134	0.7
4410	10000	6400	15000	970	2200	B64290	L0062	X***	2.85	20.72	7.28	151	0.8
4090	10000	6000	15000	900	2200	B64290	L0038	X***	3.07	24.07	7.83	188	0.9
5110	10000			1120	2200	B64290	L0044	X***	2.46	30.09	12.23	368	1.8
6030	10000			1330	2200	B64290	L0742	X***	2.08	31.17	14.96	466	2.4
4700	10000			1040	2200	B64290	L0644	X***	2.67	32.70	12.27	401	1.8
4420	10000			970	2200	B64290	L0658	X***	2.84	34.98	12.30	430	2.0
3880	10000			850	2200	B64290	L0623	X***	3.24	39.02	12.05	470	2.4
5400	10000			1190	2200	B64290	L0743	X***	2.33	36.75	15.78	580	3.0
6440	10000			1420	2200	B64290	L0045	X***	1.95	38.52	19.73	760	3.7
6280	10000			1390	2200	B64290	L0652	X***	2.00	42.00	21.04	884	4.4
13400	10000			2950	2200	B64290	L0697	X***	0.94	31.03	33.14	1029	6.9
9740	10000			2130	2200	B64290	L0632	X***	1.30	43.55	33.63	1465	7.6
± 30%		± 30%		± 25%									

Ordering code example / Bestellbeispiel

B64290L0668X065

Block 1

Ferrite toroid / Ferrit-Ringkern

Block 2

Coating material / Beschichtung:
Parylene: P, Epoxy: L, no coating: A
Type coded / Typ codiert

Block 3

X = Dummy character / Füllstelle
Code number for material
Kennziffern für Material

Ringkerne für EMV- und LAN-Anwendungen

Ringkerne werden schwerpunktmäßig als EMV-Drosseln zur Unterdrückung von HF-Störungen im MHz-Bereich und für Signalübertrager verwendet.

Typische Applikationen für Ringkerne aus NiZn-Ferriten sind LAN-Drosseln. Hier eignet sich besonders K10. Weitere Werkstoffe sind auf Anfrage erhältlich.

Auswahl an hochpermeablen MnZn-Werkstoffen im Bereich Störschutz:

- R 2.5 bis R 12.5 für Telekommunikation, z.B. ISDN (N30, T38, T46)
- R 2.5 bis R 3.94 für LAN (T57)
- R 13.3 bis R 25.3 für Netzleitungs-drosseln (N30, T65, T35 bis T46)
- > R 34 für Drosseln und Filter in Industrieanwendungen (T65)

Please read *Cautions and warnings* on page 53 and *Important notes* on page 54.
Bitte beachten Sie die Seite 53 *Warn- und Sicherheitshinweise* sowie
Wichtige Hinweise auf Seite 54.

Toroids R 22.1 ... R 202

Ringkerne R 22.1 ... R 202

Technical data Technische Daten



Type / Typ Toroid size (d _o x d _i x h) Ringkerngröße (d _o x d _i x h) (Outer diameter x inner diameter x height) mm inch	Material (Code number for ord. code, Block 3) / Werkstoff (Kennziffer für Bestellnr. Block 3) A _L values (nH) / approx. initial permeability μ _i / A _L -Werte (nH) / Anfangspermeabilität μ _i												
	K10 (X010)		N30 (X830)		T57 (X057)		T65 (X065)		T35 (X035)		T37 (X037)		
	A _L	μ _i	A _L	μ _i	A _L	μ _i	A _L	μ _i	A _L	μ _i	A _L	μ _i	
R 22.1 x 13.7 x 6.35			2610	4300			3160	5200			3950	6500	
R 22.1 x 13.7 x 7.90			3250	4300			3930	5200		4000	5300	4900	6500
R 22.1 x 13.7 x 12.5			5140	4300			6200	5200		6000	5000	7770	6500
R 22.6 x 14.7 x 9.20			3420	4300			4100	5200		4200	5300	5170	6500
R 25.3 x 14.8 x 10.0			4620	4300			5350	5000		5400	5000	6970	6500
R 25.3 x 14.8 x 15.0			6930	4300			8000	5000				10460	6500
R 25.3 x 14.8 x 20.0			9160	4300			10600	5000		10700	5000	13800	6400
R 29.5 x 19.0 x 14.9			5630	4300			6800	5200				8500	6500
R 30.5 x 20.0 x 12.5			4540	4300			5400	5100				6400	6100
R 34.0 x 20.5 x 10.0			4360	4300			5100	5000				6100	6000
R 34.0 x 20.5 x 12.5			5460	4300			6400	5000				7600	6000
R 36.0 x 23.0 x 15.0			5750	4300			6700	5000				8000	6000
R 38.1 x 19.05 x 12.7			7570	4300			8800	5000				10500	6000
R 40.0 x 24.0 x 16.0			7000	4300			8200	5000				9800	6000
R 41.8 x 26.2 x 12.5			5000	4300			5800	5000				7000	6000
R 50.0 x 30.0 x 20.0			8700	4300			10000	4900				12000	6000
R 58.3 x 32.0 x 18.0			9300	4300								13000	6000
R 58.3 x 40.8 x 17.6			5400	4300			6250	5000				7160	5700
R 58.3 x 40.8 x 20.2			6200	4300			7200	5000				8000	5600
R 63.0 x 38.0 x 25.0			10800	4300			12600	5000				13900	5500
R 68.0 x 48.0 x 13.0			3890	4300			4500	5000				5000	5500
R 87.0 x 54.3 x 13.5			5400	4300			6280	5000				7000	5500
R 102 x 65.8 x 15.0			5500	4200			6500	5000					
R 140 x 103 x 25.0			6200	4000									
R 202 x 153 x 25.0			5200	3700									
Tolerance of A _L value / A _L -Wert-Toleranz	± 25%		± 25%		± 25%		± 30%		± 25%		± 25%		

Coatings of ring cores / Beschichtung von Ringkernen

Version / Ausführung	Epoxy (blue): B64290L...	Galxyl (Parylene): B64290P...
Layer thickness / Schichtdicke	< 0.4 mm	0.012 or / oder 0.025 mm
Breakdown voltage / Durchbruchspannung	> 2 kV (> R 20)	> 1 kV (standard value / Standardwert)
Mechanical voltage / Mechan. Beschaffenheit	High firmness / Hohe Festigkeit	Smooth surface / Glatte Oberfläche
Max. temp. (short-time) / Max. Temp. (kurzzeitig)	approx. 180 °C / ca. 180 °C	approx. 130 °C / ca. 130 °C
Advantage / Vorteil	Low influence on A _L value / Ger. Einfluss auf A _L -Wert	Very low thickness / Geringe Schichtdicke
UL rating / UL-Zulassung (UL 94 V-0)	UL file no. E194412 Czech production, UL file no. E257941 Indian production	

Chamfer

Large toroidal cores use thick wires that are partially subjected to high mechanical stress during winding. This can damage the wire insulation as well as the coating of the cores, thus reducing the breakdown voltage.

To avoid this, EPCOS ring cores with diameters of more than 10 mm have a chamfer. This prevents any insulation damage, and produces uniform coating thickness at the same time.

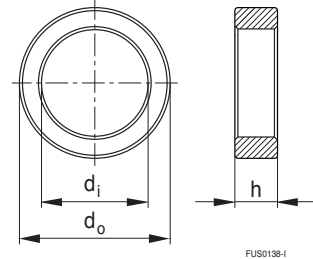

FUS0138-I

						Ordering code Bestellnummer			Magnetic characteristics Magnetische Formkenngrößen				Approx. weight Ca. Gewicht
T38 (X038)		T46 (X046)		N87 (X087)		Block 1	Block 2	Block 3	$\Sigma l/A$ mm ⁻¹	l_e mm	A_e mm ²	V_e mm ³	g
A_L	μ_i	A_L	μ_i	A_L	μ_i								
6070	10000			1340	2200	B64290	L0638	X***	2.07	54.15	26.17	1417	6.8
7570	10000			1660	2200	B64290	L0719	X***	1.66	54.15	32.55	1763	8.4
12000	10000			2630	2200	B64290	L0651	X***	1.05	54.15	51.15	2789	14
7900	10000			1740	2200	B64290	L0626	X***	1.59	56.82	35.78	2033	9.8
10700	10000			2360	2200	B64290	L0618	X***	1.17	60.07	51.26	3079	16
16100	10000			3500	2200	B64290	L0615	X***	0.78	60.07	76.89	4619	24
21300	10000			4680	2200	B64290	L0616	X***	0.59	60.07	102.5	6157	33
13100	10000			2880	2200	B64290	L0647	X***	0.96	73.78	76.98	5680	27
10600	10000			2320	2200	B64290	L0657	X***	1.19	77.02	64.66	4980	25
10100	10000			2230	2200	B64290	L0058	X***	1.24	82.06	66.08	5423	27
12700	10000			2790	2200	B64290	L0048	X***	0.99	82.06	82.60	6778	33
13500	10000			2940	2200	B64290	L0674	X***	0.94	89.65	95.89	8597	43
17600	10000			3870	2200	B64290	L0668	X***	0.71	82.97	116.2	9644	52
				3590	2200	B64290	L0659	X***	0.77	96.29	125.3	12070	61
				2560	2200	B64290	L0022	X***	1.08	103.0	95.75	9862	50
				4460	2200	B64290	L0082	X***	0.62	120.4	195.7	23560	120
				4800	2200	B64290	L0043	X***	0.58	134.0	230.0	30710	160
				2760	2200	B64290	L0040	X***	1.00	152.4	152.4	23230	115
				3200	2200	B64290	L0042	X***	0.87	152.4	174.9	26660	130
				5000	2200	B64290	L0699	X***	0.50	152.1	305.9	46530	240
				1990	2200	B64290	L0696	X***	1.39	178.6	128.7	22980	115
				2790	2200	B64290	L0730	X***	0.99	213.9	216.7	46360	235
				2880	2200	B64290	L0084	X***	0.96	255.3	267.2	68220	330
						B64290	A0705	X830	0.82	375.8	458.9	172440	860
						B64290	A0711	X830	0.90	550.5	608.6	335030	1600
± 30%		± 30%		± 25%									

Ordering code example / Bestellbeispiel

B64290L0668X065

Block 1
Ferrite toroid / Ferrit-Ringkern

Block 2
Coating material / Beschichtung:
Parylene: P, Epoxy: L, no coating: A
Type coded / Typ codiert

Block 3
X = Dummy character / Füllstelle
Code number for material
Kennziffern für Material

Angepresste Phase

Für große Ringkerne werden dicke Drähte verwendet, die bei der Bewicklung teilweise hoher mechanischer Belastung ausgesetzt sind. Dadurch kann die Isolierung der Drähte und die Beschichtung der Kerne beschädigt aber

auch die Durchbruchspannung verringert werden. Um dies zu vermeiden, haben Ringkerne von EPCOS mit Durchmesser >10 mm eine angepresste Phase. Diese vermeidet Isolationsschäden und ermöglicht zudem eine gleichmäßige Beschichtungsdicke.

Symbols and Terms

Symbole und Begriffe

Symbol	Term	Bezeichnung	Unit / Einheit
A_e	Effective magnetic cross section	Effektiver magnetischer Querschnitt	mm ²
A_L	Inductance factor: $A_L = L/N^2$	Induktivitätsfaktor: $A_L = L/N^2$	nH
A_{min}	Minimum core cross section	Min. Kernquerschnitt	mm ²
\hat{B}	Peak value of magnetic flux density	Scheitelwert der magnetischen Flussdichte	Vs/m ² , mT
ΔB	Flux density deviation	Hub der Flussdichte	Vs/m ² , mT
B_S	Saturation magnetization	Sättigungsmagnetisierung	Vs/m ² , mT
f	Frequency	Frequenz	Hz
f_{max}	Upper frequency limit	Obere Grenzfrequenz	Hz
g	Air gap	Luftspalt	mm
\hat{H}	Peak value of magnetic field strength	Scheitelwert der magnetischen Feldstärke	A/m
L	Inductance	Induktivität	H = Vs/A
L_{DC}	Inductance with DC bias	Induktivität bei Gleichstromvormagnetisierung	H
l_e	Effective magnetic path length	Effektive magnetische Weglänge	mm
N	Number of turns	Windungszahl	
P_V	Relative core losses	Bezogene Kernverlustleistung	kW/m ³
Q	Quality factor ($Q = \omega L/R_S = 1/\tan \delta_L$)	Gütefaktor ($Q = \omega L/R_S = 1/\tan \delta_L$)	
R_S	Series loss resistance of a core	Serien-Verlustwiderstand eines Kerns	Ω
T	Temperature	Temperatur	°C
T_C	Curie temperature	Curietemperatur	°C
$\tan \delta$	Loss factor	Verlustfaktor	
$\tan \delta/\mu_i$	Relative loss factor of material at $H \rightarrow 0$	Bezogener Verlustfaktor des Werkstoffes bei $H \rightarrow 0$	
V_e	Effective magnetic volume	Effektives magnetisches Volumen	mm ³
η_B	Hysteresis material constant	Hysteresematerialkonstante	mT ⁻¹
μ_i	Relative initial permeability	Relative Anfangspermeabilität	
Σ/A	Magnetic form factor	Magnetischer Formfaktor	mm ⁻¹
ω	Angular frequency; $\omega = 2 \pi f$	Kreisfrequenz; $\omega = 2 \pi f$	1/s

The commas used in numerical values denote decimal points.
All dimensions are given in mm, otherwise specified.

SMD Surface-mount device

Maße in mm, soweit nicht anders angegeben.

SMD Oberflächenmontierbares Bauelement

Cautions and Warnings

Warn- und Sicherheitshinweise

Mechanical stress and mounting

Ferrite cores have to meet mechanical requirements during assembling and for a growing number of applications. Since ferrites are ceramic materials one has to be aware of the special behavior under mechanical load.

As valid for any ceramic material, ferrite cores are brittle and sensitive to any shock, fast changing or tensile load. Especially high cooling rates under ultrasonic cleaning and high static or cyclic loads can cause cracks or failure of the ferrite cores.

For detailed information see Data Book 2007, chapter "General – Definitions, 8.1".

Effects of core combination on A_L value

Stresses in the core affect not only the mechanical but also the magnetic properties. It is apparent that the initial permeability is dependent on the stress state of the core. The higher the stresses are in the core, the lower is the value for the initial permeability. Thus the embedding medium should have the greatest possible elasticity.

For detailed information see Data Book 2007, chapter "General – Definitions, 8.2".

Heating up

Ferrites can run hot during operation at higher flux densities and higher frequencies.

NiZn-materials

The magnetic properties of NiZn-materials can change irreversible in high magnetic fields.

Processing notes

- The start of the winding process should be soft. Else the flanges may be destroyed.
- To strong winding forces may blast the flanges or squeeze the tube that the cores can no more be mount.
- To long soldering time at high temperature ($> 300\text{ °C}$) may effect coplanarity or pin arrangement.
- Not following the processing notes for soldering of the J-leg terminals may cause solderability problems at the transformer because of pollution with Sn oxyd of the tin bath or burned insulation of the wire.
For detailed information see Data Book 2007, chapter "Processing notes, 2.2".
- The dimensions of the hole arrangement have fixed values and should be understood as a recommendation for drilling the printed circuit board. For dimensioning the pins, the group of holes can only be seen under certain conditions, as they fit into the given hole arrangement. To avoid problems when mounting the transformer, the manufacturing tolerances for positioning the customers' drilling process must be considered by increasing the hole diameter.

Mechanische Belastungen und Montage

Ferritkerne müssen den Belastungen bei der Montage und den verschiedenen Anwendungen standhalten. Ferrite sind ein keramischer Werkstoff und daher ist das besondere Verhalten bei mechanischer Belastung zu berücksichtigen.

Wie jede Keramik sind auch Ferritkerne spröde und empfindlich gegenüber Schock sowie sich schnell ändernden oder Zug-Belastungen. Insbesondere das beschleunigte Kühlen bei der Ultraschallreinigung sowie eine hohe statische oder zyklische Belastung kann zu Rissen oder Ausfällen der Ferritkerne führen.

Siehe hierzu auch das englischsprachige Ferrite-Datenbuch 2007, Kapitel „General – Definitions, 8.1“.

Auswirkungen von Kernkombinationen auf den A_L -Wert

Spannungen im Kern beeinflussen nicht nur die mechanischen, sondern auch die magnetischen Eigenschaften. Es zeigt sich eine Abhängigkeit der Anfangspermeabilität vom Spannungszustand des Kerns.

Der Wert der Anfangspermeabilität ist umso niedriger, je höher die Spannungen im Kern sind. Daher sollten Vergussmassen eine möglichst große Elastizität aufweisen.

Siehe hierzu auch das englischsprachige Ferrite-Datenbuch 2007, Kapitel „General – Definitions, 8.2“.

Erwärmung

Ferrite können sich während des Betriebs bei höherer magnetischer Flussdichte und höheren Frequenzen erwärmen.

NiZn-Werkstoff

Die magnetischen Eigenschaften von NiZn-Werkstoffen können sich in hohen magnetischen Feldern irreversibel ändern.

Verarbeitungshinweise

- Der Wicklungsprozess sollte sanft anlaufen, da sonst der Flansch beschädigt werden kann.
- Zu große Wickelkräfte können den Flansch sprengen oder den Wickelkörper quetschen, so dass der Kern nicht mehr montiert werden kann.
- Eine zu lange Lötdauer bei hohen Temperaturen ($> 300\text{ °C}$) kann sich nachteilig auf die Koplanarität oder die Lage der Stifte auswirken.
- Die Nichtbeachtung der Löttempfehlungen für J-Anschlüsse kann Lötprobleme beim Übertrager verursachen. Diese können auftreten wegen Verunreinigung des Zinnbades mit Sn-Oxiden oder Resten der verbrannten Isolierung des Drahtes.
Siehe hierzu auch das englischsprachige Ferrite-Datenbuch 2007, Kapitel "Processing notes, 2.2".
- Die Maße der Lochgruppe sind feste Werte und eine Empfehlung für die Bohrung der Leiterplatte. Für die Bemaßung der Stifte kann die Lochgruppe nur bedingt gesehen werden, dass sie in die gegebene Lochgruppe passen. Um Probleme bei der Montage des Übertragers zu vermeiden, müssen bei der Bohrung der Lochgruppe die Fertigungstoleranzen des Kunden berücksichtigt werden, indem die Lochdurchmesser um die Fertigungstoleranzen erweitert werden.

Important Notes

Wichtige Hinweise

The following applies to all products named in this publication:

1. Some parts of this publication contain **statements about the suitability of our products for certain areas of application**. These statements are based on our knowledge of typical requirements that are often placed on our products in the areas of application concerned. We nevertheless expressly point out **that such statements cannot be regarded as binding statements about the suitability of our products for a particular customer application**. As a rule, EPCOS is either unfamiliar with individual customer applications or less familiar with them than the customers themselves. For these reasons, it is always ultimately incumbent on the customer to check and decide whether an EPCOS product with the properties described in the product specification is suitable for use in a particular customer application.
2. We also point out that **in individual cases, a malfunction of electronic components or failure before the end of their usual service life cannot be completely ruled out in the current state of the art, even if they are operated as specified**. In customer applications requiring a very high level of operational safety and especially in customer applications in which the malfunction or failure of an electronic component could endanger human life or health (e.g. in accident prevention or life-saving systems), it must therefore be ensured by means of suitable design of the customer application or other action taken by the customer (e.g. installation of protective circuitry or redundancy) that no injury or damage is sustained by third parties in the event of malfunction or failure of an electronic component.
3. **The warnings, cautions and product-specific notes must be observed.**

4. In order to satisfy certain technical requirements, **some of the products described in this publication may contain substances subject to restrictions in certain jurisdictions (e.g. because they are classed as hazardous)**. Useful information on this will be found in our Material Data Sheets on the Internet (www.epcos.com/material). Should you have any more detailed questions, please contact our sales offices.

5. We constantly strive to improve our products. Consequently, **the products described in this publication may change from time to time**. The same is true of the corresponding product specifications. Please check therefore to what extent product descriptions and specifications contained in this publication are still applicable before or when you place an order.

We also **reserve the right to discontinue production and delivery of products**. Consequently, we cannot guarantee that all products named in this publication will always be available. The aforementioned does not apply in the case of individual agreements deviating from the foregoing for customer-specific products.

6. Unless otherwise agreed in individual contracts, **all orders are subject to the current version of the "General Terms of Delivery for Products and Services in the Electrical Industry" published by the German Electrical and Electronics Industry Association (ZVEI)**.
7. The trade names EPCOS, BAOKE, Alu-X, CeraDiode, CSSP, CTVS, DSPP, MiniBlue, MKK, MLSC, MotorCap, PCC, PhaseCap, PhaseMod, SIFERRIT, SIFI, SIKOREL, SilverCap, SIMDAD, SIMID, SineFormer, SIOV, SIP5D, SIP5K, ThermoFuse, WindCap are **trademarks registered or pending** in Europe and in other countries. Further information will be found on the Internet at www.epcos.com/trademarks.

Für alle in dieser Publikation genannten Produkte gilt:

1. Diese Publikation enthält an einigen Stellen **Aussagen über die Eignung unserer Produkte für bestimmte Anwendungsgebiete**. Diese Aussagen basieren auf unserer Kenntnis von typischen Anforderungen, die auf den genannten Anwendungsgebieten häufig an unsere Produkte gestellt werden. Wir weisen aber ausdrücklich darauf hin, **dass derartige Aussagen nicht als verbindliche Aussagen zur Eignung unserer Produkte für eine bestimmte Kundenanwendung zu werten sind**. In aller Regel kennt EPCOS die einzelne Kundenanwendung entweder nicht oder ist mit der Anwendung und ihren Anforderungen weniger vertraut als der Kunde selbst. Es obliegt deshalb letztlich immer dem Kunden, zu prüfen und zu entscheiden, ob ein EPCOS-Produkt mit seinen in der Produktspezifikation beschriebenen Eigenschaften für den Einsatz in der jeweiligen individuellen Kundenanwendung geeignet ist.
2. Außerdem weisen wir darauf hin, dass **nach dem derzeitigen Stand der Technik selbst bei spezifikationsgemäßem Betrieb in Einzelfällen eine Fehlfunktion elektronischer Bauelemente oder ein Ausfall vor Ende ihrer üblichen Lebensdauer nicht vollständig auszuschließen ist**. Bei Kundenanwendungen, welche ein sehr hohes Maß an Betriebssicherheit erfordern und insbesondere bei Kundenanwendungen, bei denen eine Fehlfunktion oder ein Ausfall eines elektronischen Bauelementes zu einer Gefährdung von Gesundheit oder Leben von Menschen führen könnte (z. B. unfallverhütende oder lebensschützende Systeme), muss deshalb durch geeignete Konstruktion der Kundenanwendung oder durch sonstige kundenseitige Maßnahmen (z. B. durch Einbau von Schutzschaltungen oder Redundanzen) dafür gesorgt werden, dass auch bei Fehlfunktion oder Ausfall eines elektronischen Bauelementes keine Verletzung von Rechtsgütern Dritter eintritt.
3. **Die Warn- und Sicherheitshinweise sowie produktspezifischen Anmerkungen sind unbedingt zu beachten.**

4. Um bestimmten technischen Anforderungen gerecht zu werden, **können einige der in dieser Publikation aufgeführten Produkte Substanzen enthalten, die nach länderspezifischen Regelungen Restriktionen unterliegen (z. B. weil sie als gefährlich eingestuft werden)**. Nützliche Informationen dazu enthalten unsere Materialdatenblätter im Internet (www.epcos.de/material). Bei weitergehenden Fragen wenden Sie sich bitte an unsere Vertriebsbüros.

5. Wir bemühen uns laufend, unsere Produkte zu verbessern. Infolge dessen **ändern sich die in dieser Publikation beschriebenen Produkte von Zeit zu Zeit**. Gleiches gilt auch für die entsprechenden Produktspezifikationen. Vergewissern Sie sich deshalb vor oder bei Ihrer Bestellung, inwieweit die in der vorliegenden Publikation angegebenen Produktbeschreibungen und Produktspezifikationen noch gelten.

Im übrigen **behalten wir uns vor, die Produktion und Lieferung von Produkten einzustellen**. Eine Gewähr für die dauerhafte Verfügbarkeit aller in dieser Publikation genannten Produkte können wir deshalb nicht übernehmen. Die vorstehenden Regelungen gelten nicht, sofern in Hinblick auf kundenspezifische Bauteile abweichende Vereinbarungen getroffen werden.

6. Außer in Fällen, in denen abweichende individualvertragliche Vereinbarungen getroffen werden, **gelten für Bestellungen die jeweils aktuell vom Zentralverband Elektrotechnik- und Elektronikindustrie e.V. (ZVEI) herausgegebenen „Allgemeinen Lieferbedingungen für Erzeugnisse und Leistungen der Elektroindustrie“**.
7. Die Bezeichnungen EPCOS, BAOKE, Alu-X, CeraDiode, CSSP, CTVS, DSPP, MiniBlue, MKK, MLSC, MotorCap, PCC, PhaseCap, PhaseMod, SIFERRIT, SIFI, SIKOREL, SilverCap, SIMDAD, SIMID, SineFormer, SIOV, SIP5D, SIP5K, ThermoFuse, WindCap sind in Europa und in anderen Ländern **registrierte oder zum Schutz angemeldete Marken**. Weitere Informationen hierzu finden Sie im Internet unter www.epcos.de/trademarks.

Get in Contact

Europe

Austria, Bulgaria, Montenegro, Romania, Serbia

EPCOS OHG
Vienna
T +43 51 70 72 56 30
F +43 51 70 75 56 45
sales.csee@epcos.com

Czech Republic

EPCOS s.r.o.
Prague
T +420 2 33 03 22 81
F +420 2 33 03 22 89
sales.czech@epcos.com

Finland

EPCOS Nordic OY
Espoo
T +358 10 5 11 32 00
F +358 10 5 11 22 85
sales.nordic@epcos.com

France, Belgium, Luxembourg, Malta, Netherlands

EPCOS SAS
Saint-Denis/France
T +33 1 49 46 67 89
F +33 1 49 46 67 67
sales.france@epcos.com

Germany, Liechtenstein, Switzerland

EPCOS AG
Customer Service
Munich
T (D) 0180 500 33 48
(0,14 Euro/min.)
(CH) 08 48 37 26 71
F +49 89 63 62 80 10
sales.germany@epcos.com

Greece

EPCOS OHG
Vienna
T +43 51 70 72 56 30
F +43 51 70 75 56 45
sales.greece@epcos.com

Hungary

EPCOS Elektronikai
Alkatrész Kft.
Budapest
T +36 1 436 07 20
F +36 1 436 07 21
sales.hungary@epcos.com

Italy

Siemens S. p. A.
Settore EPCOS
Milan
T +39 02 24 36 42 65
F +39 02 24 36 44 24
sales.italy@epcos.com

Poland, Latvia, Lithuania

Siemens Sp.z.o.o
EPCOS Division
Warsaw
T +48 22 8 70 91 51
F +48 22 8 70 91 59
sales.poland@epcos.com

Portugal

EPCOS 2 Portugal LDA
Évora
T +351 91 75 67 927
F +351 21 49 33 476
sales.portugal@epcos.com

Russia, Belarus, Kazakhstan, Moldavia, Ukraine

OOO Siemens
EPCOS Division
Moscow
T +7 495 7 37 24 17 / 18
F +7 495 7 37 23 46
sales.cis@epcos.com

Slovakia

EPCOS Sales Representative
Dolný Kubín
T +42 1 43 5 82 36 73
F +42 1 43 5 82 37 33
sales.slovakia@epcos.com

Slovenia, Croatia, Bosnia & Herzegovina

EPCOS Sales Representative
Škofljica/Slovenia
T +386 599 56 35 3
F +386 599 56 35 4
sales.slovenia@epcos.com

Spain

Siemens S.A.
EPCOS Division
Getafe
T +34 91 514 80 00
F +34 91 514 70 14
sales.iberia@epcos.com

Sweden, Estonia, Iceland, Denmark, Norway

EPCOS Nordic AB
Kista/Sweden
T +46 8 4 77 27 00
F +46 8 4 77 27 01
sales.nordic@epcos.com

Turkey

EPCOS AG
Liaison Office
Istanbul
T +90 216 5 69 81 01
F +90 216 4 64 07 56
sales.turkey@epcos.com

United Kingdom, Ireland

EPCOS UK Ltd.
Bracknell
T +44 13 44 38 15 10
F +44 13 44 38 15 12
sales.uk@epcos.com

Asia

Afghanistan, Iran, Iraq, Jordan, Lebanon, Syria

EPCOS AG
Liaison Office
Istanbul/Turkey
T +90 216 5 69 81 01
F +90 216 4 64 07 56
sales.turkey@epcos.com

China

EPCOS (Shanghai) Ltd.
Shanghai
T +86 21 33 02 46 20
F +86 21 63 91 68 89
sales.cn@epcos.com

Hong Kong

EPCOS Limited
Hong Kong
T +85 2 31 01 56 00
F +85 2 31 01 56 46
sales.cn@epcos.com

India, Bahrain, Bangladesh, Kuwait, Nepal, Oman, Pakistan, Qatar, Saudi Arabia, Sri Lanka, United Arab Emirates

EPCOS India Private Ltd.
Bangalore
T +91 80 40 39 06 15
F +91 80 40 39 06 03
sales.in@epcos.com

Israel

Nisko Projects Electronics & Communications (1999) Ltd.
Tel Aviv
T +972 37 65 73 00
F +972 37 65 73 33
sales.israel@epcos.com

Japan

EPCOS KK
Yokohama
T +81 45 4 78 72 00
F +81 45 4 78 72 25
sales.jp@epcos.com

Korea

Siemens Ltd.
EPCOS Division
Seoul
T +82 2 34 50 75 70
F +82 2 34 50 75 98
sales.kr@epcos.com

Malaysia

EPCOS SDN. BHD.
Kuala Lumpur
T +60 3 79 60 81 80
F +60 3 79 60 81 82
sales.asean@epcos.com

Philippines

Siemens Inc.
EPCOS Division
Manila
T +63 2 8 78 94 41
F +63 2 8 78 94 40
sales.asean@epcos.com

Singapore, Indonesia, Thailand, Vietnam

EPCOS PTE LTD
Singapore
T +65 68 41 20 11
F +65 67 44 69 92
sales.asean@epcos.com

Taiwan

EPCOS Taiwan Co. Ltd.
Taipei
T +886 2 26 55 76 76
F +886 2 55 59 02 88
sales.tw@epcos.com

Americas

USA, Canada, Mexico

EPCOS, Inc.
Iselin, NJ, USA
T +1 732 9 06 43 00
F +1 732 9 06 43 95
sales.usa@epcos.com

South America

EPCOS do Brasil Ltda.
São Paulo
T +55 1 138 17 34 46
F +55 1 138 17 34 43
sales.br@epcos.com

Australia

Australia, New Zealand

Electronic Component Solutions Pty Ltd
Melbourne
T +61 3 85 61 19 19
F +61 3 95 74 70 55
sales.au@epcos.com

Africa

Republic of South Africa

Electrocomp (PTY) Ltd.
Sandton
T +27 11 458 90 00 32
F +27 11 458 90 34
sales.southernafrica@epcos.com

Egypt

Siemens Ltd.
EPCOS Division
Cairo
T +202 3 333 36 69
F +202 3 333 36 07
sales.egypt@epcos.com

Morocco, Tunisia

EPCOS SAS
Saint-Denis/France
T +33 1 49 46 67 89
F +33 1 49 46 67 67
sales.france@epcos.com

03/08

The addresses of our worldwide distributors and regional sales offices are available at www.epcos.com/sales

© EPCOS AG, Corporate Center, P.O.Box 80 17 09, 81617 Munich, Germany, T +49 89 636 09, F +49 89 636 226 89
Reproduction, publication and dissemination of this publication and the information contained therein without EPCOS' prior express consent is prohibited.

