

## Power Cord Input EMC Filter IF 13

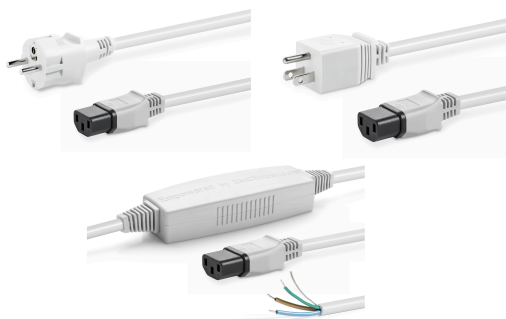

- High frequency attenuation
- Shielding and ferrite cable
- Easy to integrate in any design
- Retrofit for any IEC C14 inlet
- Rated current up to 10A
- Various powerline plugs for international usage



### Technical Specifications

<b>Maximum continuous operating voltage</b>	250 VAC (120V for US plug version), 50/60 Hz
<b>Rated currents</b>	10 A
<b>High potential test voltage</b>	IF13-SE: P -> N 1200 VDC (1 min) P+N -> PE 2100 VDC (1 min) IF13-SE: P+N -> PE 2100 VAC (1 min 50Hz) P -> N 2100 VDC (1 min)
<b>Protection category</b>	IP 20 according IEC 60529
<b>Temperature range (operation and storage)</b>	-25°C to +70°C
<b>Connector (load side)</b>	IEC C13 according to IEC/EN 60320-2-2 stripped ends
<b>Connector (line side) and cables</b>	Schuko Plug CEE7/VII US NEMA5-15 plug standard stripped ends
<b>Flammability corresponding to</b>	Cable: UL VW-1

### Approvals & Compliances



The IF13 power cord with integrated filter is the easiest way to integrate an EMC filter into a given design (with a power cord). The approach to incorporate the filter in an external cable can help to pass compliance testing at the end of the design phase. The performance of the filter is enhanced through the ferrite cable and shielding. With different versions of input and output connections the cord can be easily implemented. Complying with RoHS and REACH the power cords fulfill worldwide environmental regulations.

### Features and Benefits

- Easy to implement, no redesign required
- EMC lifeline at last design stage
- High performance in high frequency range
- Retrofit for cord connected devices
- no space allocation required for filter

### Typical Applications

- All cord connected applications
- Datacenter
- Communication Technology
- Medical and Laboratory devices
- Security applications
- High frequency applications
- Applications with critical housing dimensions (cable is external)

### Typical Electrical Schematics

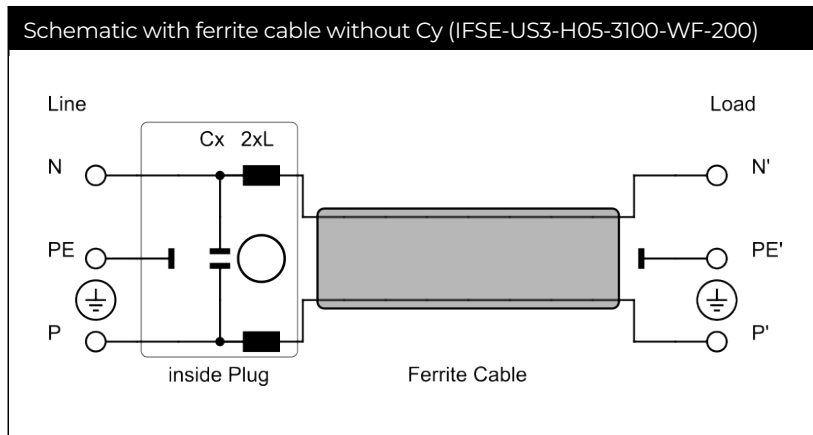
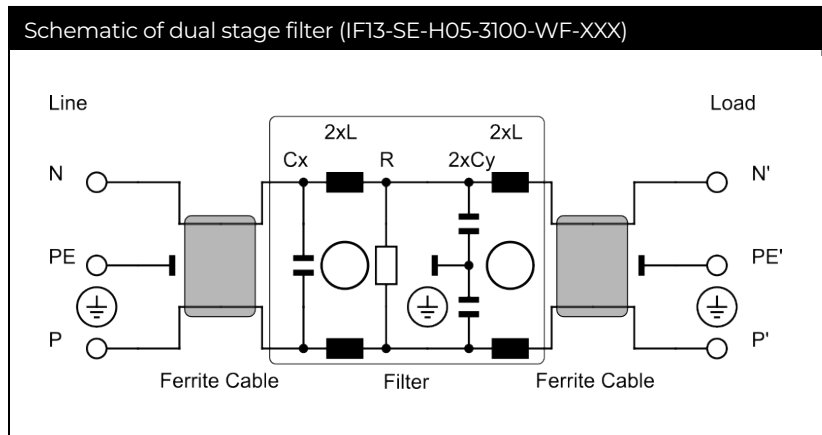
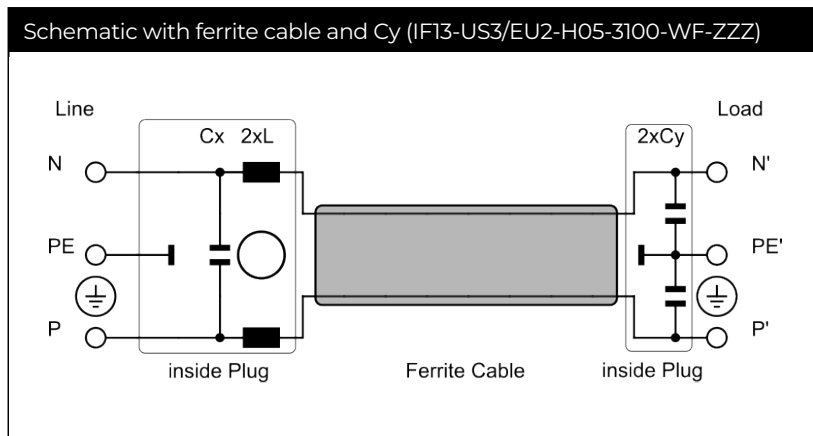
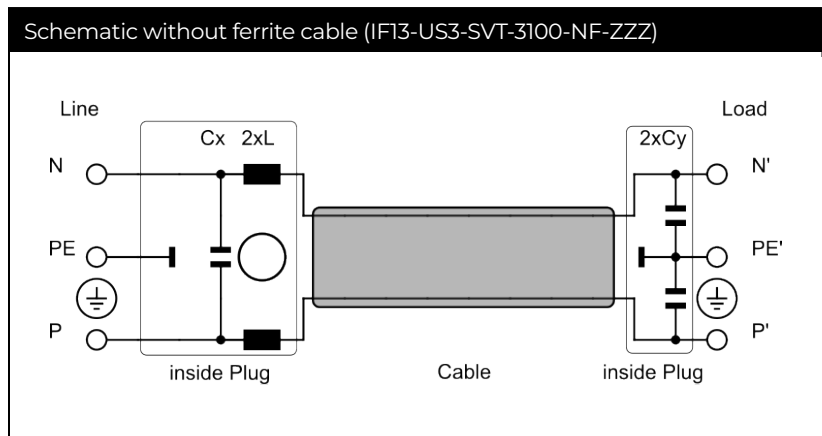

### Filter Selection Table

Filter*	Rated current @ 40°C (25°C) [A]	Leakage current** @ 250V AC/50 Hz (@ 120V AC/60 Hz) [mA]	Inductance L [mH]	Capacitance		Resistance R [kΩ]	Ferrite Cable***	Input connection	Output connection	Weight (200 cm) [g]
				Cx [μF]	Cy [nF]					
IF13-US3-SVT-3100-NF-...	10	0.31 (0.18)	0.8	0.1	2.2	no	NEMA5-15	C13	240	
IF13-US3-H05-3100-WF-...	10	0.31 (0.18)	0.8	0.1	2.2	yes	NEMA5-15	C13	340	
IF13-EU2-H05-3100-WF-...	10	0.31 (0.18)	0.8	0.1	2.2	yes	CEE7/VII	C13	360	
IF13-SE-H05-3100-WF-...	10	0.31 (0.18)	0.8 (2x)	0.1	2.2	1000	yes	Stripped Ends	C13	410
IFSE-US3-H05-3100-WF-...	10	0	0.8	0.1			yes	NEMA5-15	Stripped Ends	310

\* To compile a complete part number, please replace the .. with the required length.

\*\* Maximum leakage under usual AC operating conditions (acc. IEC 60939-3). Note: if the neutral line is interrupted, worst case leakage could reach twice this level.

\*\*\* All cable is shielded

Product selector IF 13

### IFxx-yyy-zzz-aaaa-bb-ccc:

- Cable length:** 200 – 200cm
- Cable version:** WF – With ferrite cable  
NF – without ferrite cable
- Cable core:** 3100 – 3 X 1.00 mm<sup>2</sup> (US: AWG 18)
- Cable type:** H05 - H05VV-F  
SVT - SVT
- Line side plug:** EU2 – CEE7/VII straight, integrated filter  
US3 – NEMA5-15, straight, integrated filter  
SE – with stripped ends
- Load side plug:** 13 - IEC C13 female plug, straight, integrated filter  
SE – with stripped ends

### Cable\* Selection Table IF 13

<b>IF 13-US3-SVT-3100-NF-...</b>	IEC cable assembly with input EMC Filter, IEC C13 connector, without ferrite coated cable, US version
<b>IF 13-US3-H05-3100-WF-...</b>	IEC cable assembly with input EMC Filter, IEC C13 connector, with ferrite coated cable, US version
<b>IF 13-EU2-H05-3100-WF-...</b>	IEC cable assembly with input EMC Filter, IEC C13 connector, with ferrite coated cable, EU version
<b>IF 13-SE-H05-3100-WF-...</b>	IEC cable assembly with EMC Filter, IEC C13 connector, with ferrite coated cable, stripped version
<b>IF SE-US3-H05-3100-WF-...</b>	IEC cable assembly with input EMC Filter, stripped output, with ferrite coated cable, US version

\* All cables are shielded

### Typical Filter Attenuation

Per CISPR 17; A=50 Ω/50 Ω sym; B=50 Ω/50 Ω asym

IF13-US3-SVT-3100-NF-200

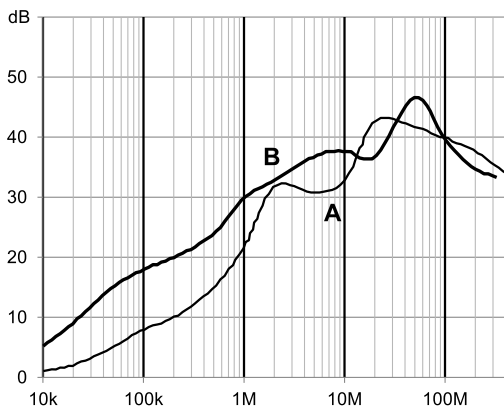

IF13-US3-H05-3100-WF-200

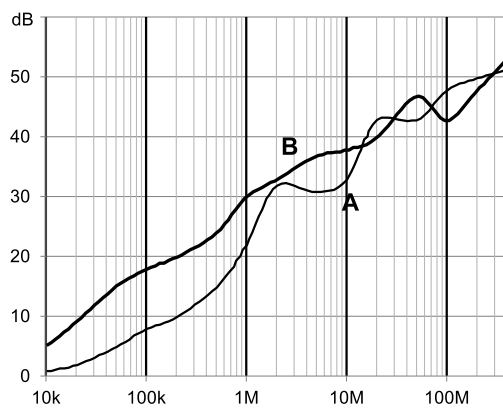

IF13-EU2-H05-3100-WF-200

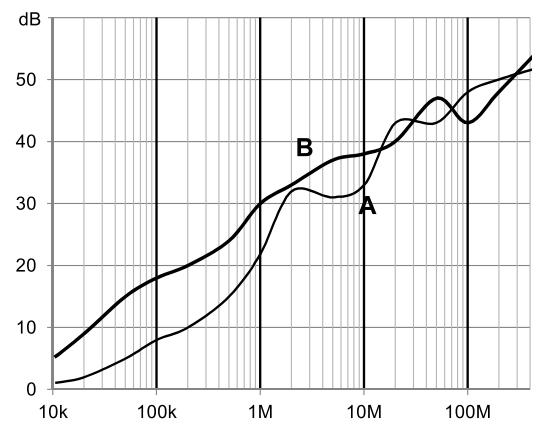

IF13-SE-H05-3100-WF-200

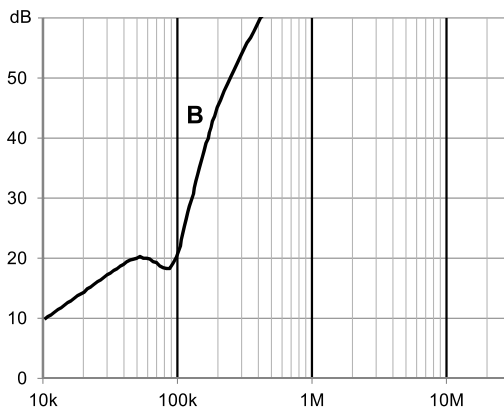

IFSE-US3-H05-3100-WF-200

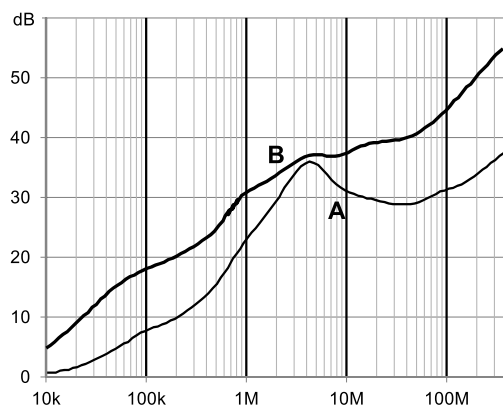

### Mechanical Data

#### F13-US3-SVT-3100-NF

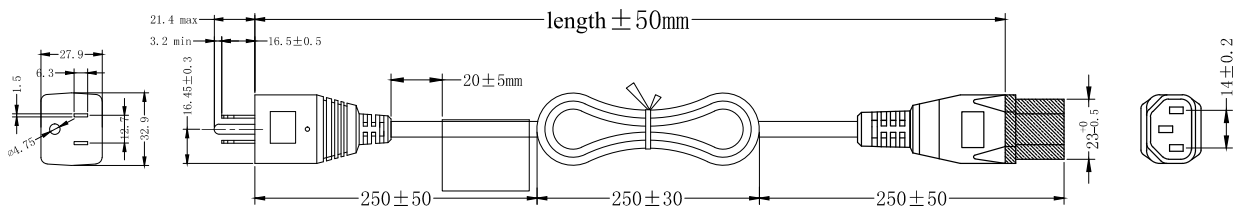

#### IF13-US3-H05-3100-WF

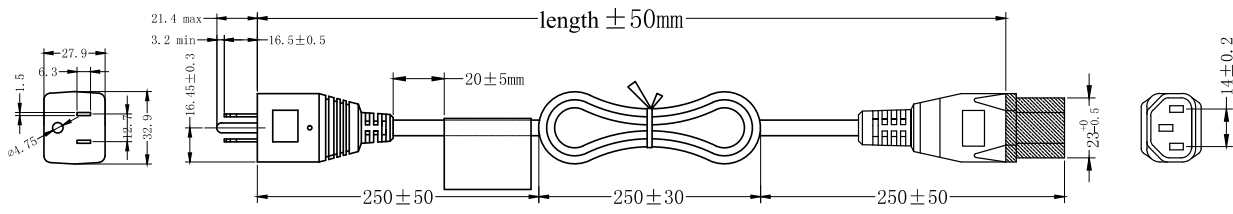

#### IF13-EU2-H05-3100-WF

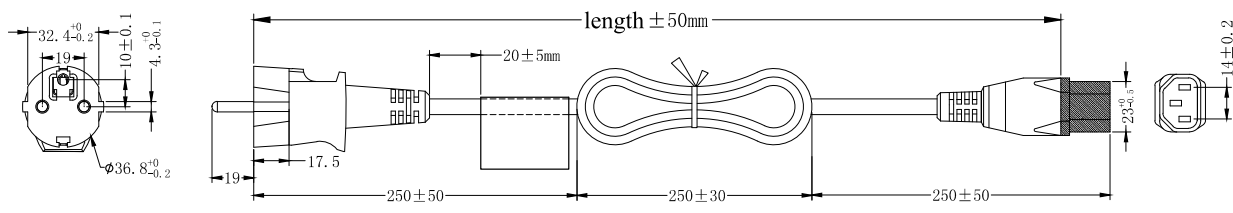

#### IF13-SE-H05-3100-WF-200

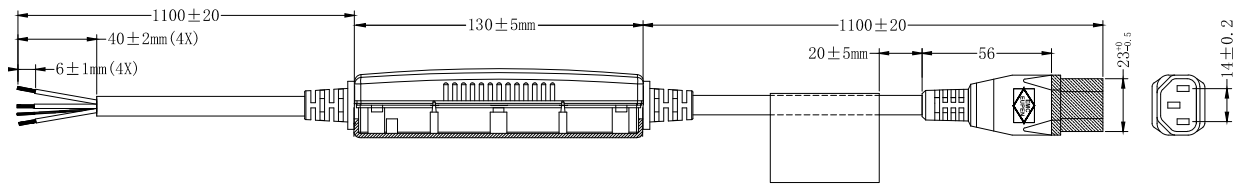

#### IFSE-US3-H05-3100-WF

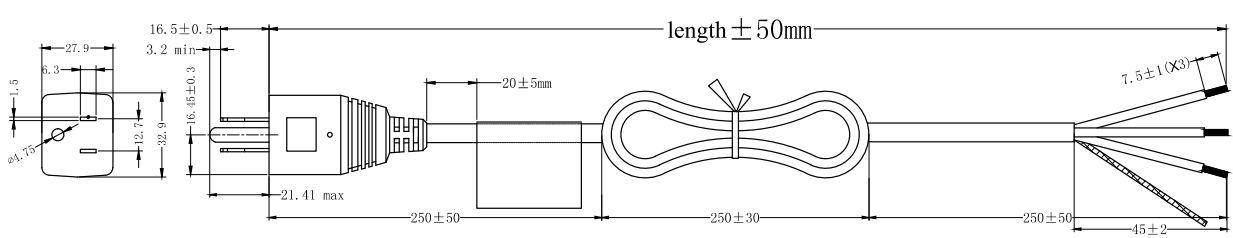

Please visit [www.schaffner.com](http://www.schaffner.com) to find more details on filter connectors.

## Headquarters, Global Innovation and Development

### Switzerland

#### Schaffner Holding AG

Industrie Nord  
Nordstrasse 11e  
4542  
Luterbach  
+41 32 681 66 26  
[info@schaffner.com](mailto:info@schaffner.com)

## Sales and Application Centers

### Germany

#### Schaffner Deutschland GmbH

Schoemperlenstrasse 12B  
76185  
Karlsruhe  
+49 721 56910  
[germanysales@schaffner.com](mailto:germanysales@schaffner.com)

### Singapore

#### Schaffner EMC Pte Ltd.

Blk 3015A Ubi Road 1 #05-09 Kampong Ubi  
Industrial Estate  
408705  
Singapore  
+65 63773283  
[singaporesales@schaffner.com](mailto:singaporesales@schaffner.com)

### United Kingdom

#### Schaffner Ltd.

Suite 1 Oakmede Place  
Terrace Road  
RG42 4JF  
Binfield  
+44 118 9770070  
[uksales@schaffner.com](mailto:uksales@schaffner.com)

### Thailand

#### Schaffner EMC Co. Ltd.

Sathorn Square Tower  
Room 3780 37FL 98 North-Sathorn Rd Silom  
Bangrak  
10500  
Bangkok  
+66 621056397  
[thailandsales@schaffner.com](mailto:thailandsales@schaffner.com)

### Taiwan

#### Schaffner EMV Ltd.

U-Town  
20 Floor-2 No 97 Section 1 XinTai 5th Road  
XiZhi District  
22175  
New Taipei City  
+886 226975500  
[taiwansales@schaffner.com](mailto:taiwansales@schaffner.com)

### France

#### Schaffner EMC S.A.S.

16-20 Rue Louis Rameau  
95875  
Bezons  
+33 1 34 34 30 60  
[francesales@schaffner.com](mailto:francesales@schaffner.com)

### Finland

#### Schaffner Oy

Sauvonrinne 19 H  
8500  
Lohja  
+358 50 468 7284  
[finlandsales@schaffner.com](mailto:finlandsales@schaffner.com)

### China

#### Schaffner EMC Ltd. Shanghai

T20-3 C No 565 Chuangye Road Pudong  
district  
201201  
Shanghai  
+86 2138139500  
[cschina@schaffner.com](mailto:cschina@schaffner.com)

### Japan

#### Schaffner EMC K.K.

ISM Sangenjaya 7F  
1-32-12 Kamiuma Setagaya-ku  
154-0011  
Tokyo  
+81 3 5712 3650  
[japansales@schaffner.com](mailto:japansales@schaffner.com)

### United States

#### Schaffner EMC Inc.

52 Mayfield Avenue  
Edison, New Jersey  
+1 732 225 9533  
[usasales@schaffner.com](mailto:usasales@schaffner.com)

### Italy

#### Schaffner EMC S.r.l.

Via Ticino, 30  
20900  
Monza (MB)  
+39 039 21 41 070  
[italysales@schaffner.com](mailto:italysales@schaffner.com)

### India

#### Schaffner India Pvt. Ltd

Regus World Trade Centre  
WTC 22nd Floor Unit No 2238 Brigade  
Gateway Campus 26/1 Dr. Rajkumar Road  
Mallechwaram (W)  
560055  
Bangalore  
+91 8067935355  
[indiasales@schaffner.com](mailto:indiasales@schaffner.com)

### Switzerland

#### Schaffner EMV AG

Industrie Nord  
Nordstrasse 11e  
4542  
Luterbach  
+41 32 681 66 26  
[switzerlandsales@schaffner.com](mailto:switzerlandsales@schaffner.com)

### Sweden

#### Schaffner EMC AB

Östermalmstrorg 1  
114 42  
Stockholm  
+46 8 5050 2425  
[swedensales@schaffner.com](mailto:swedensales@schaffner.com)

### Spain

#### Schaffner EMC España

Calle Caléndula 93 Miniparc III Edificio E El  
Soto de Moraleja Alcobendas  
28109  
Madrid  
+34 917 912 900  
[spainsales@schaffner.com](mailto:spainsales@schaffner.com)

To find your local partner within Schaffner's global network [schaffner.com](http://schaffner.com)

© 2022 Schaffner Group

The content of this document has been carefully checked and understood. However, neither Schaffner nor its subsidiaries assume any liability whatsoever for any errors or inaccuracies of this document and the consequences thereof. Published specifications are subject to change without notice. Product suitability for any area of application must ultimately be determined by the customer. In all cases, products must never be operated outside their published specifications. Schaffner does not guarantee the availability of all published products. This disclaimer shall be governed by substantive Swiss law and resulting disputes shall be settled by the courts at the place of business of Schaffner Holding AG. Latest publications and a complete disclaimer can be downloaded from the Schaffner website. All trademarks recognized.

# Mouser Electronics

Authorized Distributor

Click to View Pricing, Inventory, Delivery & Lifecycle Information:

Schaffner:

[IF13-EU2-H05-3100-WF-200](#) [IF13-US3-H05-3100-WF-200](#) [IFSE-US3-H05-3100-WF-200](#) [IF13-SE-H05-3100-WF-200](#)

[IF13-US3-SVT-3100-NF-200](#)