

FEATURES

- Low on resistance (4 Ω)**
- On resistance flatness (0.2 Ω)**
- 44 V supply maximum ratings**
- ±15 V analog signal range**
- Fully specified at ±5 V, 12 V, ±15 V**
- Ultralow power dissipation (18 μW)**
- ESD 2 kV**
- Continuous current (100 mA)**
- Fast switching times**
- t_{ON} 70 ns**
- t_{OFF} 60 ns**
- TTL-/CMOS-compatible**
- Pin-compatible upgrade for ADG411/ADG412/ADG413 and ADG431/ADG432/ADG433**

APPLICATIONS

- Relay replacement**
- Audio and video switching**
- Automatic test equipment**
- Precision data acquisition**
- Battery-powered systems**
- Sample-and-hold systems**
- Communication systems**
- PBX, PABX systems**
- Avionics**

GENERAL DESCRIPTION

The ADG451/ADG452/ADG453 are monolithic CMOS devices comprising four independently selectable switches. They are designed on an enhanced LC²MOS process that provides low power dissipation yet gives high switching speed and low on resistance.

The on resistance profile is very flat over the full analog input range, ensuring excellent linearity and low distortion when switching audio signals. Fast switching speed, coupled with high signal bandwidth, makes the parts suitable for video signal switching. CMOS construction ensures ultralow power dissipation, making the parts ideally suited for portable and battery-powered instruments.

The ADG451/ADG452/ADG453 contain four independent, single-pole/single-throw (SPST) switches. The ADG451 and ADG452 differ only in that the digital control logic is inverted. The ADG451 switches are turned on with a logic low on the appropriate control input, while a logic high is required for the ADG452.

Rev. C

Information furnished by Analog Devices is believed to be accurate and reliable. However, no responsibility is assumed by Analog Devices for its use, nor for any infringements of patents or other rights of third parties that may result from its use. Specifications subject to change without notice. No license is granted by implication or otherwise under any patent or patent rights of Analog Devices. Trademarks and registered trademarks are the property of their respective owners.

FUNCTIONAL BLOCK DIAGRAMS

SWITCHES SHOWN FOR A LOGIC 1 INPUT.

Figure 1. ADG451

05239-001



SWITCHES SHOWN FOR A LOGIC 1 INPUT.

Figure 2. ADG452

05239-101



SWITCHES SHOWN FOR A LOGIC 1 INPUT.

Figure 3. ADG453

05239-102

The ADG453 has two switches with digital control logic similar to that of the ADG451, while the logic is inverted on the other two switches.

Each switch conducts equally well in both directions when on, and each has an input signal range that extends to the supplies. In the off condition, signal levels up to the supplies are blocked.

The ADG453 exhibits break-before-make switching action for use in multiplexer applications. Inherent in the design is low charge injection for minimum transients when switching the digital inputs.

TABLE OF CONTENTS

Features	1	Absolute Maximum Ratings	7
Applications.....	1	ESD Caution.....	7
General Description	1	Pin Configuration and Function Descriptions.....	8
Functional Block Diagrams.....	1	Typical Performance Characteristics	9
Revision History	2	Terminology	11
Product Highlights	3	Applications.....	12
Specifications.....	4	Test Circuits.....	13
15 V Dual Supply.....	4	Outline Dimensions	15
12 V Single Supply.....	5	Ordering Guide	16
5 V Dual Supply.....	6		

REVISION HISTORY

10/06—Rev. B to Rev. C

Changes to Table 4.....	9
Changes to Ordering Guide	18

12/04—Rev. A to Rev. B

Updated Format.....	Universal
Changes to Specifications Section	3
Changes to Absolute Maximum Ratings Section	8
Changes to Pin Configuration and Function Descriptions Section	9
Updated Outline Dimensions	16
Changes to Ordering Guide	17

2/98—Rev. 0 to Rev. A

10/97—Revision 0: Initial Version

PRODUCT HIGHLIGHTS

1. Low R_{ON} (5 Ω maximum).
2. Ultralow Power Dissipation.
3. Extended Signal Range.
The ADG451/ADG452/ADG453 are fabricated on an enhanced LC²MOS process, giving an increased signal range that fully extends to the supply rails.
4. Break-Before-Make Switching.
This prevents channel shorting when the switches are configured as a multiplexer (ADG453 only.)
5. Single-Supply Operation.
For applications in which the analog signal is unipolar, the ADG451/ADG452/ADG453 can be operated from a single rail power supply. The parts are fully specified with a single 12 V power supply and remain functional with single supplies as low as 5.0 V.
6. Dual-Supply Operation.
For applications where the analog signal is bipolar, the ADG451/ADG452/ADG453 can be operated from a dual power supply ranging from ± 4.5 V to ± 20 V.

ADG451/ADG452/ADG453

SPECIFICATIONS

15 V DUAL SUPPLY

$V_{DD} = 15\text{ V}$, $V_{SS} = -15\text{ V}$, $V_L = 5\text{ V}$, $GND = 0\text{ V}$. All specifications T_{MIN} to T_{MAX} , unless otherwise noted.

Table 1.

Parameter	B Version ¹		Unit	Test Conditions/Comments
	25°C	T_{MIN} to T_{MAX}		
ANALOG SWITCH				
Analog Signal Range			V	
On Resistance (R_{ON})	4		Ω typ	$V_D = -10\text{ V}$ to $+10\text{ V}$, $I_S = -10\text{ mA}$
	5	7	Ω max	
On Resistance Match Between Channels (ΔR_{ON})	0.1		Ω typ	$V_D = \pm 10\text{ V}$, $I_S = -10\text{ mA}$
	0.5	0.5	Ω max	
On Resistance Flatness ($R_{FLAT(ON)}$)	0.2		Ω typ	$V_D = -5\text{ V}$, 0 V , $+5\text{ V}$, $I_S = -10\text{ mA}$
	0.5	0.5	Ω max	
LEAKAGE CURRENTS²				
Source Off Leakage, I_S (OFF)	± 0.02		nA typ	$V_D = \pm 10\text{ V}$, $V_S = \pm 10\text{ V}$; see Figure 17
	± 0.5	± 2.5	nA max	
Drain Off Leakage, I_D (OFF)	± 0.02		nA typ	$V_D = \pm 10\text{ V}$, $V_S = \pm 10\text{ V}$; see Figure 17
	± 0.5	± 2.5	nA max	
Channel On Leakage, I_D , I_S (ON)	± 0.04		nA typ	$V_D = V_S = \pm 10\text{ V}$; see Figure 18
	± 1	± 5	nA max	
DIGITAL INPUTS				
Input High Voltage, V_{INH}		2.4	V min	
Input Low Voltage, V_{INL}		0.8	V max	
Input Current, I_{INL} or I_{INH}	0.005		μA typ	$V_{IN} = V_{INL}$ or V_{INH} ; all others = 2.4 V or 0.8 V, respectively
		± 0.5	μA max	
DYNAMIC CHARACTERISTICS³				
t_{ON}	70		ns typ	$R_L = 300\ \Omega$, $C_L = 35\text{ pF}$, $V_S = \pm 10\text{ V}$; see Figure 19
	180	220	ns max	
t_{OFF}	60		ns typ	$R_L = 300\ \Omega$, $C_L = 35\text{ pF}$, $V_S = \pm 10\text{ V}$; see Figure 19
	140	180	ns max	
Break-Before-Make Time Delay, t_D (ADG453 Only)	15		ns typ	$R_L = 300\ \Omega$, $C_L = 35\text{ pF}$, $V_{S1} = V_{S2} = +10\text{ V}$; see Figure 20
	5	5	ns min	
Charge Injection	20		pC typ	$V_S = 0\text{ V}$, $R_S = 0\ \Omega$, $C_L = 1.0\text{ nF}$; see Figure 21
	30		pC max	
Off Isolation	65		dB typ	$R_L = 50\ \Omega$, $C_L = 5\text{ pF}$, $f = 1\text{ MHz}$; see Figure 22
Channel-to-Channel Crosstalk	-90		dB typ	$R_L = 50\ \Omega$, $C_L = 5\text{ pF}$, $f = 1\text{ MHz}$; see Figure 23
C_S (OFF)	37		pF typ	$f = 1\text{ MHz}$
C_D (OFF)	37		pF typ	$f = 1\text{ MHz}$
C_D , C_S (ON)	140		pF typ	$f = 1\text{ MHz}$
POWER REQUIREMENTS				
I_{DD}	0.0001		μA typ	$V_{DD} = 16.5\text{ V}$, $V_{SS} = -16.5\text{ V}$; digital inputs = 0 V or 5 V
	0.5	5	μA max	
I_{SS}	0.0001		μA typ	
	0.5	5	μA max	
I_L	0.0001		μA typ	
	0.5	5	μA max	
I_{GND} ³	0.0001		μA typ	
	0.5	5	μA max	

¹ Temperature range for B version is -40°C to $+85^\circ\text{C}$.

² $T_{MAX} = 70^\circ\text{C}$.

³ Guaranteed by design, not subject to production test.

12 V SINGLE SUPPLY

$V_{DD} = 12\text{ V}$, $V_{SS} = 0\text{ V}$, $V_L = 5\text{ V}$, $GND = 0\text{ V}$. All specifications T_{MIN} to T_{MAX} , unless otherwise noted.

Table 2.

Parameter	B Version ¹		Unit	Test Conditions/Comments
	25°C	T_{MIN} to T_{MAX}		
ANALOG SWITCH				
Analog Signal Range		0 V to V_{DD}	V	
On Resistance (R_{ON})	6		Ω typ	$V_D = 0\text{ V}$ to $+10\text{ V}$, $I_S = -10\text{ mA}$
	8	10	Ω max	
On Resistance Match Between Channels (ΔR_{ON})	0.1		Ω typ	$V_D = 10\text{ V}$, $I_S = -10\text{ mA}$
	0.5	0.5	Ω max	
On Resistance Flatness ($R_{FLAT(ON)}$)	1.0	1.0	Ω typ	$V_D = 0\text{ V}$, 5 V , $I_S = -10\text{ mA}$
LEAKAGE CURRENTS^{2, 3}				
Source Off Leakage, I_S (OFF)	± 0.02		nA typ	$V_D = 0\text{ V}$, 10 V , $V_S = 0\text{ V}$, 10 V ; see Figure 17
	± 0.5	± 2.5	nA max	
Drain Off Leakage, I_D (OFF)	± 0.02		nA typ	$V_D = 0\text{ V}$, 10 V , $V_S = 0\text{ V}$, 10 V ; see Figure 17
	± 0.5	± 2.5	nA max	
Channel On Leakage, I_D , I_S (ON)	± 0.04		nA typ	$V_D = V_S = 0\text{ V}$, 10 V ; see Figure 18
	± 1	± 5	nA max	
DIGITAL INPUTS				
Input High Voltage, V_{INH}		2.4	V min	
Input Low Voltage, V_{INL}		0.8	V max	
Input Current, I_{INL} or I_{INH}	0.005		μA typ	$V_{IN} = V_{INL}$ or V_{INH}
		± 0.5	μA max	
DYNAMIC CHARACTERISTICS⁴				
t_{ON}	100		ns typ	$R_L = 300\ \Omega$, $C_L = 35\text{ pF}$, $V_S = 8\text{ V}$; see Figure 19
	220	260	ns max	
t_{OFF}	80		ns typ	$R_L = 300\ \Omega$, $C_L = 35\text{ pF}$, $V_S = 8\text{ V}$; see Figure 19
	160	200	ns max	
Break-Before-Make Time Delay, t_D (ADG453 Only)	15		ns typ	$R_L = 300\ \Omega$, $C_L = 35\text{ pF}$, $V_{S1} = V_{S2} = 8\text{ V}$; see Figure 20
	10	10	ns min	
Charge Injection	10		pC typ	$V_S = 6\text{ V}$, $R_S = 0\ \Omega$, $C_L = 1.0\text{ nF}$; see Figure 21
Channel-to-Channel Crosstalk	-90		dB typ	$R_L = 50\ \Omega$, $C_L = 5\text{ pF}$, $f = 1\text{ MHz}$; see Figure 23
C_S (OFF)	60		pF typ	$f = 1\text{ MHz}$
C_D (OFF)	60		pF typ	$f = 1\text{ MHz}$
C_D , C_S (ON)	100		pF typ	$f = 1\text{ MHz}$
POWER REQUIREMENTS				
I_{DD}	0.0001		μA typ	$V_{DD} = 13.2\text{ V}$; digital inputs = 0 V or 5 V
	0.5	5	μA max	
I_L	0.0001		μA typ	
	0.5	5	μA max	$V_L = 5.5\text{ V}$
I_{GND} ⁴	0.0001		μA typ	
	0.5	5	μA max	$V_L = 5.5\text{ V}$

¹ Temperature range for B version is -40°C to $+85^\circ\text{C}$.

² $T_{MAX} = 70^\circ\text{C}$.

³ Tested with dual supplies.

⁴ Guaranteed by design, not subject to production test.

ADG451/ADG452/ADG453

5 V DUAL SUPPLY

$V_{DD} = +5\text{ V}$, $V_{SS} = -5\text{ V}$, $V_L = +5\text{ V}$, $GND = 0\text{ V}$. All specifications T_{MIN} to T_{MAX} , unless otherwise noted.

Table 3.

Parameter	B Version ¹		Unit	Test Conditions/Comments
	25°C	T_{MIN} to T_{MAX}		
ANALOG SWITCH				
Analogue Signal Range		V_{SS} to V_{DD}	V	
On Resistance (R_{ON})	7		Ω typ	$V_D = -3.5\text{ V}$ to $+3.5\text{ V}$, $I_S = -10\text{ mA}$
	12	15	Ω max	
On Resistance Match Between Channels (ΔR_{ON})	0.3		Ω typ	$V_D = 3.5\text{ V}$, $I_S = -10\text{ mA}$
	0.5	0.5	Ω max	
LEAKAGE CURRENTS^{2, 3}				
Source Off Leakage, I_S (OFF)	± 0.02		nA typ	$V_D = \pm 4.5$, $V_S = \pm 4.5$; see Figure 17
	± 0.5	± 2.5	nA max	
Drain Off Leakage, I_D (OFF)	± 0.02		nA typ	$V_D = 0\text{ V}$, 5 V , $V_S = 0\text{ V}$, 5 V ; see Figure 17
	± 0.5	± 2.5	nA max	
Channel On Leakage, I_D , I_S (ON)	± 0.04		nA typ	$V_D = V_S = 0\text{ V}$, 5 V ; see Figure 18
	± 1	± 5	nA max	
DIGITAL INPUTS				
Input High Voltage, V_{INH}		2.4	V min	
Input Low Voltage, V_{INL}		0.8	V max	
Input Current, I_{INL} or I_{INH}	0.005		μA typ	$V_{IN} = V_{INL}$ or V_{INH}
		± 0.5	μA max	
DYNAMIC CHARACTERISTICS⁴				
t_{ON}	160		ns typ	$R_L = 300\ \Omega$, $C_L = 35\text{ pF}$, $V_S = 3\text{ V}$; see Figure 19
	220	300	ns max	
t_{OFF}	60		ns typ	$R_L = 300\ \Omega$, $C_L = 35\text{ pF}$, $V_S = 3\text{ V}$; see Figure 19
	140	180	ns max	
Break-Before-Make Time Delay, t_D (ADG453 Only)	50		ns typ	$R_L = 300\ \Omega$, $C_L = 35\text{ pF}$, $V_{S1} = V_{S2} = 3\text{ V}$; see Figure 20
	5	5	ns min	
Charge Injection	10		pC typ	$V_S = 0\text{ V}$, $R_S = 0\ \Omega$, $C_L = 1.0\text{ nF}$; see Figure 21
Off Isolation	65		dB typ	$R_L = 50\ \Omega$, $C_L = 5\text{ pF}$, $f = 1\text{ MHz}$; see Figure 22
Channel-to-Channel Crosstalk	-76		dB typ	$R_L = 50\ \Omega$, $C_L = 5\text{ pF}$, $f = 1\text{ MHz}$; see Figure 23
C_S (OFF)	48		pF typ	$f = 1\text{ MHz}$
C_D (OFF)	48		pF typ	$f = 1\text{ MHz}$
C_D , C_S (ON)	148		pF typ	$f = 1\text{ MHz}$
POWER REQUIREMENTS				
I_{DD}	0.0001		μA typ	$V_{DD} = 5.5\text{ V}$; digital inputs = 0 V or 5 V
	0.5	5	μA max	
I_{SS}	0.0001		μA typ	
	0.5	5	μA max	
I_L	0.0001		μA typ	
	0.5	5	μA max	$V_L = 5.5\text{ V}$
I_{GND}^4	0.0001		μA typ	
	0.5	5	μA max	$V_L = 5.5\text{ V}$

¹ Temperature range for B version is -40°C to $+85^\circ\text{C}$.

² $T_{MAX} = 70^\circ\text{C}$.

³ Tested with dual supplies.

⁴ Guaranteed by design, not subject to production test.

ABSOLUTE MAXIMUM RATINGS

$T_A = 25^\circ\text{C}$, unless otherwise noted.

Table 4.

Parameters	Ratings
V_{DD} to V_{SS}	44 V
V_{DD} to GND	-0.3 V to +32 V
V_{SS} to GND	+0.3 V to -32 V
V_L to GND	-0.3 V to $V_{DD} + 0.3$ V
Analog, Digital Inputs ¹	$V_{SS} - 2$ V to $V_{DD} + 2$ V or 30 mA, whichever occurs first
Continuous Current, S or D	100 mA
Peak Current, S or D (pulsed at 1 ms, 10% duty cycle maximum)	300 mA
Operating Temperature Range	
Industrial (B Version)	-40°C to +85°C
Storage Temperature Range	-65°C to +150°C
Junction Temperature	150°C
Plastic DIP Package, Power Dissipation	470 mW
θ_{JA} Thermal Impedance	117°C/W
Lead Temperature, Soldering (10 sec)	260°C
SOIC Package, Power Dissipation	600 mW
θ_{JA} Thermal Impedance	77°C/W
TSSOP Package, Power Dissipation	450 mW
θ_{JA} Thermal Impedance	115°C/W
θ_{JC} Thermal Impedance	35°C/W
Lead Temperature, Soldering	
Vapor Phase (60 sec)	215°C
Infrared (15 sec)	220°C
ESD	2 kV

¹ Overvoltages at IN, S, or D are clamped by internal diodes. Current should be limited to the maximum ratings given.

Stresses above those listed under Absolute Maximum Ratings may cause permanent damage to the device. This is a stress rating only; functional operation of the device at these or any other conditions above those listed in the operational sections of this specification is not implied. Exposure to absolute maximum rating conditions for extended periods may affect device reliability.

Only one absolute maximum rating may be applied at any one time.

ESD CAUTION



ESD (electrostatic discharge) sensitive device. Charged devices and circuit boards can discharge without detection. Although this product features patented or proprietary protection circuitry, damage may occur on devices subjected to high energy ESD. Therefore, proper ESD precautions should be taken to avoid performance degradation or loss of functionality.

ADG451/ADG452/ADG453

PIN CONFIGURATION AND FUNCTION DESCRIPTIONS



Figure 4. Pin Configuration

Table 5. Pin Function Descriptions

Pin No.	Mnemonic	Description
1	IN1	Logic Control Input.
2	D1	Drain Terminal. Can be an input or an output.
3	S1	Source Terminal. Can be an input or an output.
4	V _{SS}	Most Negative Power Supply Potential in Dual Supplies. In single-supply applications, it can be connected to GND.
5	GND	Ground (0 V) Reference.
6	S4	Source Terminal. Can be an input or an output.
7	D4	Drain Terminal. Can be an input or an output.
8	IN4	Logic Control Input.
9	IN3	Logic Control Input.
10	D3	Drain Terminal. Can be an input or an output.
11	S3	Source Terminal. Can be an input or an output.
12	V _L	Logic Power Supply (5 V).
13	V _{DD}	Most Positive Power Supply Potential.
14	S2	Source Terminal. Can be an input or an output.
15	D2	Drain Terminal. Can be an input or an output.
16	IN2	Logic Control Input.

Table 6. Truth Table (ADG451/ADG452)

ADG451 In	ADG452 In	Switch Condition
0	1	On
1	0	Off

Table 7. Truth Table (ADG453)

Logic	Switch 1, Switch 4	Switch 2, Switch 3
0	Off	On
1	On	Off

TYPICAL PERFORMANCE CHARACTERISTICS



Figure 5. On Resistance as a Function of V_D (V_S) for Various Dual Supplies

05239-003

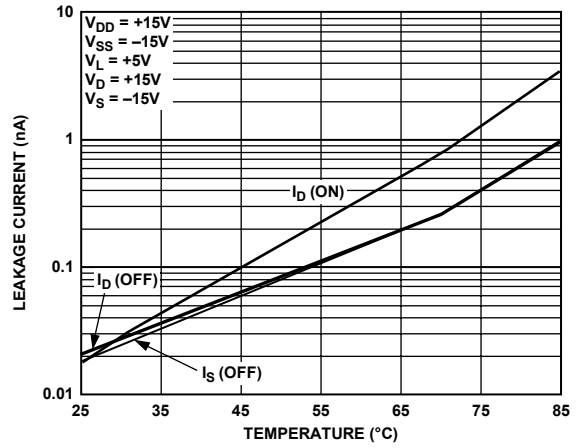

Figure 8. Leakage Currents as a Function of Temperature

05239-006



Figure 6. On Resistance as a Function of V_D (V_S) for Different Temperatures with Dual Supplies

05239-004

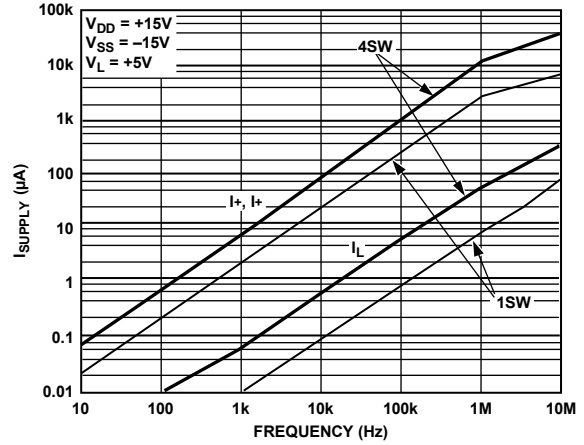

Figure 9. Supply Current vs. Input Switching Frequency

05239-007



Figure 7. On Resistance as a Function of V_D (V_S) for Various Single Supplies

05239-005

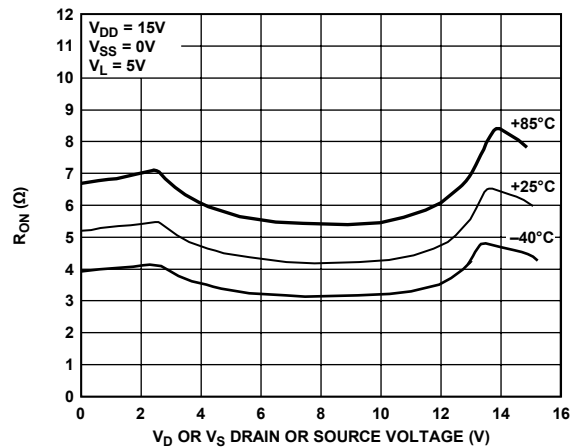

Figure 10. On Resistance as a Function of V_D (V_S) for Different Temperatures with Single Supplies

05239-008

ADG451/ADG452/ADG453



Figure 11. Leakage Currents as a Function of V_D (V_S)

05239-009



Figure 13. Crosstalk vs. Frequency

05239-011



Figure 12. Off Isolation vs. Frequency

05239-010



Figure 14. Frequency Response with Switch On

05239-012

TERMINOLOGY

R_{ON}

Ohmic resistance between D and S.

ΔR_{ON}

On resistance match between any two channels, that is, R_{ON} maximum minus R_{ON} minimum.

$R_{FLAT(ON)}$

Flatness is defined as the difference between the maximum and minimum value of on resistance, as measured over the specified analog signal range.

I_S (OFF)

Source leakage current with the switch off.

I_D (OFF)

Drain leakage current with the switch off.

I_D, I_S (ON)

Channel leakage current with the switch on.

V_D (V_S)

Analog voltage on Terminal D and Terminal S.

C_S (OFF)

Off switch source capacitance.

C_D (OFF)

Off switch drain capacitance.

C_D (ON), C_S (ON)

On switch capacitance.

t_{ON}

Delay between applying the digital control input and the output switching on. See Figure 19.

t_{OFF}

Delay between applying the digital control input and the output switching off.

t_D

Off time or on time measured between the 90% points of both switches, when switching from one address state to another. See Figure 20.

Crosstalk

A measure of unwanted signal coupled through from one channel to another as a result of parasitic capacitance.

Off Isolation

A measure of unwanted signal coupling through an off switch.

Charge Injection

A measure of the glitch impulse transferred from the digital input to the analog output during switching.

APPLICATIONS

Figure 15 illustrates a precise, fast, sample-and-hold circuit. An [AD845](#) is used as the input buffer, and the output operational amplifier is an [AD711](#). During track mode, SW1 is closed, and the output, V_{OUT} , follows the input signal, V_{IN} . In hold mode, SW1 is opened, and the signal is held by the hold capacitor, C_H .



Figure 15. Fast, Accurate Sample-and-Hold Circuit

Due to switch and capacitor leakage, the voltage on the hold capacitor decreases with time. The ADG451/ADG452/ADG453 minimize this droop due to their low leakage specifications. The droop rate is further minimized by the use of a polystyrene hold capacitor. The droop rate for the circuit shown is typically $30 \mu\text{V}/\mu\text{s}$.

A second switch, SW2, which operates in parallel with SW1, is included in this circuit to reduce pedestal error. Because both switches are at the same potential, they have a differential effect on the op amp, AD711, which minimizes charge injection effects. Pedestal error is also reduced by the compensation network, R_C and C_C . This compensation network reduces the hold time glitch while optimizing the acquisition time. Using the illustrated op amps and component values, the pedestal error has a maximum value of 5 mV over the $\pm 10 \text{ V}$ input range. Both the acquisition and settling times are 850 ns.

05239-013

TEST CIRCUITS



Figure 16. On Resistance



Figure 17. Off Leakage



Figure 18. On Leakage

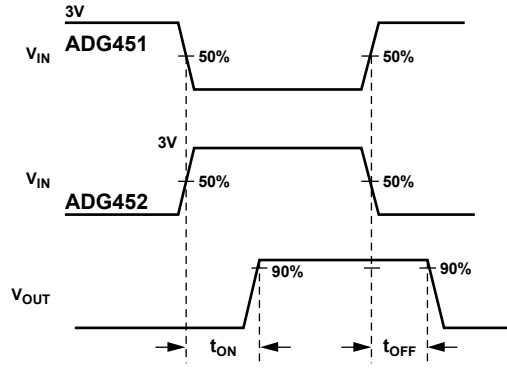

Figure 19. Switching Times

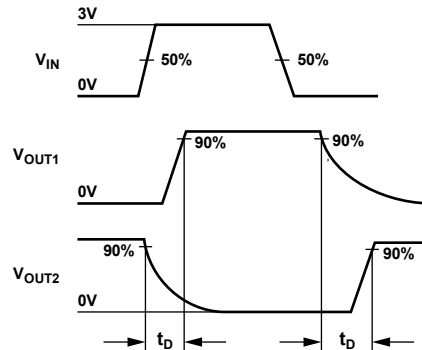

Figure 20. Break-Before-Make Time Delay

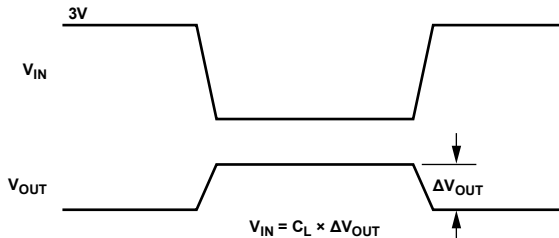

Figure 21. Charge Injection

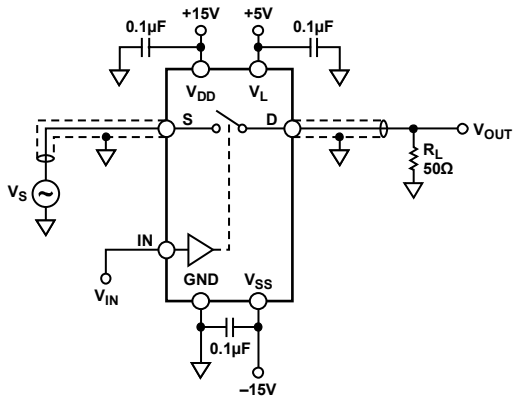

Figure 22. Off Isolation

05239-020



$$\text{CHANNEL-TO-CHANNEL CROSSTALK} = 20 \times \log |V_S/V_{OUT}|$$

Figure 23. Channel-to-Channel Crosstalk

05239-021

OUTLINE DIMENSIONS



COMPLIANT TO JEDEC STANDARDS MS-012-AC

CONTROLLING DIMENSIONS ARE IN MILLIMETERS; INCH DIMENSIONS (IN PARENTHESES) ARE ROUNDED-OFF MILLIMETER EQUIVALENTS FOR REFERENCE ONLY AND ARE NOT APPROPRIATE FOR USE IN DESIGN.

Figure 24. 16-Lead Standard Small Outline Package [SOIC_N] Narrow Body (R-16)
Dimensions shown in millimeters and (inches)



COMPLIANT TO JEDEC STANDARDS MO-153-AB

Figure 25. 16-Lead Thin Shrink Small Outline Package [TSSOP] (RU-16)
Dimensions shown in millimeters



COMPLIANT TO JEDEC STANDARDS MS-001-AB

CONTROLLING DIMENSIONS ARE IN INCHES; MILLIMETER DIMENSIONS (IN PARENTHESES) ARE ROUNDED-OFF INCH EQUIVALENTS FOR REFERENCE ONLY AND ARE NOT APPROPRIATE FOR USE IN DESIGN. CORNER LEADS MAY BE CONFIGURED AS WHOLE OR HALF LEADS.

Figure 26. 16-Lead Plastic Dual In-Line Package [PDIP] Narrow Body (N-16)
Dimensions shown in inches and (millimeters)

ADG451/ADG452/ADG453

ORDERING GUIDE

Model	Temperature Range	Package Description	Package Option
ADG451BN	-40°C to +85°C	16-Lead Plastic Dual In-Line Package [PDIP]	N-16
ADG451BNZ ¹	-40°C to +85°C	16-Lead Plastic Dual In-Line Package [PDIP]	N-16
ADG451BR	-40°C to +85°C	16-Lead Standard Small Outline Package [SOIC_N]	R-16
ADG451BR-REEL	-40°C to +85°C	16-Lead Standard Small Outline Package [SOIC_N]	R-16
ADG451BR-REEL7	-40°C to +85°C	16-Lead Standard Small Outline Package [SOIC_N]	R-16
ADG451BRZ ¹	-40°C to +85°C	16-Lead Standard Small Outline Package [SOIC_N]	R-16
ADG451BRZ-REEL ¹	-40°C to +85°C	16-Lead Standard Small Outline Package [SOIC_N]	R-16
ADG451BRZ-REEL7 ¹	-40°C to +85°C	16-Lead Standard Small Outline Package [SOIC_N]	R-16
ADG451BRUZ ¹	-40°C to +85°C	16-Lead Thin Shrink Small Outline Package [TSSOP]	RU-16
ADG451BRUZ-REEL ¹	-40°C to +85°C	16-Lead Thin Shrink Small Outline Package [TSSOP]	RU-16
ADG451BRUZ-REEL7 ¹	-40°C to +85°C	16-Lead Thin Shrink Small Outline Package [TSSOP]	RU-16
ADG451BCHIPS		DIE	
ADG452BN	-40°C to +85°C	16-Lead Plastic Dual In-Line Package [PDIP]	N-16
ADG452BNZ ¹	-40°C to +85°C	16-Lead Plastic Dual In-Line Package [PDIP]	N-16
ADG452BR	-40°C to +85°C	16-Lead Standard Small Outline Package [SOIC_N]	R-16
ADG452BR-REEL	-40°C to +85°C	16-Lead Standard Small Outline Package [SOIC_N]	R-16
ADG452BR-REEL7	-40°C to +85°C	16-Lead Standard Small Outline Package [SOIC_N]	R-16
ADG452BRZ ¹	-40°C to +85°C	16-Lead Standard Small Outline Package [SOIC_N]	R-16
ADG452BRZ-REEL ¹	-40°C to +85°C	16-Lead Standard Small Outline Package [SOIC_N]	R-16
ADG452BRZ-REEL7 ¹	-40°C to +85°C	16-Lead Standard Small Outline Package [SOIC_N]	R-16
ADG452BRUZ ¹	-40°C to +85°C	16-Lead Thin Shrink Small Outline Package [TSSOP]	RU-16
ADG452BRUZ-REEL ¹	-40°C to +85°C	16-Lead Thin Shrink Small Outline Package [TSSOP]	RU-16
ADG452BRUZ-REEL7 ¹	-40°C to +85°C	16-Lead Thin Shrink Small Outline Package [TSSOP]	RU-16
ADG453BN	-40°C to +85°C	16-Lead Plastic Dual In-Line Package [PDIP]	N-16
ADG453BNZ ¹	-40°C to +85°C	16-Lead Plastic Dual In-Line Package [PDIP]	N-16
ADG453BR	-40°C to +85°C	16-Lead Standard Small Outline Package [SOIC_N]	R-16
ADG453BR-REEL	-40°C to +85°C	16-Lead Standard Small Outline Package [SOIC_N]	R-16
ADG453BR-REEL7	-40°C to +85°C	16-Lead Standard Small Outline Package [SOIC_N]	R-16
ADG453BRZ ¹	-40°C to +85°C	16-Lead Standard Small Outline Package [SOIC_N]	R-16
ADG453BRZ-REEL ¹	-40°C to +85°C	16-Lead Standard Small Outline Package [SOIC_N]	R-16
ADG453BRZ-REEL7 ¹	-40°C to +85°C	16-Lead Standard Small Outline Package [SOIC_N]	R-16
ADG453BRUZ ¹	-40°C to +85°C	16-Lead Thin Shrink Small Outline Package [TSSOP]	RU-16
ADG453BRUZ-REEL ¹	-40°C to +85°C	16-Lead Thin Shrink Small Outline Package [TSSOP]	RU-16
ADG453BRUZ-REEL7 ¹	-40°C to +85°C	16-Lead Thin Shrink Small Outline Package [TSSOP]	RU-16

¹ Z = Pb-free part.