

IRF9328PbF

HEXFET® Power MOSFET

V_{DS}	-30	V
$R_{DS(on) \max}$ (@ $V_{GS} = -10V$)	11.9	mΩ
$R_{DS(on) \max}$ (@ $V_{GS} = -4.5V$)	19.7	mΩ
Q_g (typical)	18	nC
I_D (@ $T_A = 25^\circ C$)	-12	A

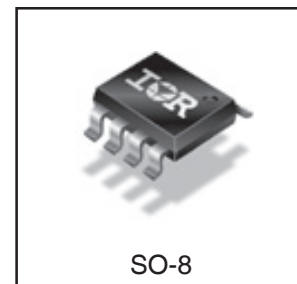
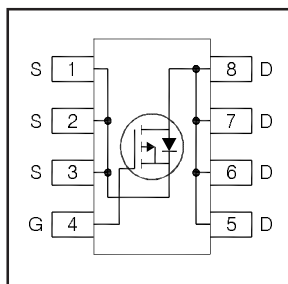

Applications

- Charge and Discharge Switch for Notebook PC Battery Application

Features and Benefits

Features

Industry-Standard SO8 Package
RoHS Compliant Containing no Lead, no Bromide and no Halogen

Resulting Benefits

Multi-Vendor Compatibility
Environmentally Friendlier

Orderable part number	Package Type	Standard Pack		Note
		Form	Quantity	
IRF9328PbF	SO8	Tube/Bulk	95	
IRF9328TRPbF	SO8	Tape and Reel	4000	

Absolute Maximum Ratings

	Parameter	Max.	Units
V_{DS}	Drain-to-Source Voltage	-30	V
V_{GS}	Gate-to-Source Voltage	± 20	
$I_D @ T_A = 25^\circ C$	Continuous Drain Current, $V_{GS} @ 10V$	-12	A
$I_D @ T_A = 70^\circ C$	Continuous Drain Current, $V_{GS} @ 10V$	-9.6	
I_{DM}	Pulsed Drain Current ①	-96	
$P_D @ T_A = 25^\circ C$	Power Dissipation ②	2.5	W
$P_D @ T_A = 70^\circ C$	Power Dissipation ②	1.6	
	Linear Derating Factor	0.02	W/°C
T_J	Operating Junction and	-55 to + 150	°C
T_{STG}	Storage Temperature Range		

Static @ T_J = 25°C (unless otherwise specified)

	Parameter	Min.	Typ.	Max.	Units	Conditions
BV _{DSS}	Drain-to-Source Breakdown Voltage	-30	—	—	V	V _{GS} = 0V, I _D = -250μA
ΔBV _{DSS} /ΔT _J	Breakdown Voltage Temp. Coefficient	—	0.021	—	V/°C	Reference to 25°C, I _D = -1mA
R _{DS(on)}	Static Drain-to-Source On-Resistance	—	10	11.9	mΩ	V _{GS} = -10V, I _D = -12A ③
		—	16.1	19.7		V _{GS} = -4.5V, I _D = -9.6A ③
V _{GS(th)}	Gate Threshold Voltage	-1.3	-1.8	-2.4	V	V _{DS} = V _{GS} , I _D = -25μA
ΔV _{GS(th)}	Gate Threshold Voltage Coefficient	—	-5.8	—	mV/°C	
I _{DSS}	Drain-to-Source Leakage Current	—	—	-1.0	μA	V _{DS} = -24V, V _{GS} = 0V
		—	—	-150		V _{DS} = -24V, V _{GS} = 0V, T _J = 125°C
I _{GSS}	Gate-to-Source Forward Leakage	—	—	-100	nA	V _{GS} = -20V
	Gate-to-Source Reverse Leakage	—	—	100		V _{GS} = 20V
g _{fs}	Forward Transconductance	20	—	—	S	V _{DS} = -10V, I _D = -9.6A
Q _g	Total Gate Charge ⑥	—	18	—	nC	V _{DS} = -15V, V _{GS} = -4.5V, I _D = -9.6A
Q _g	Total Gate Charge ⑥	—	35	52	nC	V _{GS} = -10V
Q _{gs}	Gate-to-Source Charge ⑥	—	5.3	—		V _{DS} = -15V
Q _{gd}	Gate-to-Drain Charge ⑥	—	8.5	—		I _D = -9.6A
R _G	Gate Resistance ⑥	—	15	—	Ω	
t _{d(on)}	Turn-On Delay Time	—	19	—	ns	V _{DD} = -15V, V _{GS} = -4.5V ③
t _r	Rise Time	—	57	—		I _D = -1.0A
t _{d(off)}	Turn-Off Delay Time	—	80	—		R _G = 6.8Ω
t _f	Fall Time	—	66	—		See Figs. 20a & 20b
C _{iss}	Input Capacitance	—	1680	—	pF	V _{GS} = 0V
C _{oss}	Output Capacitance	—	350	—		V _{DS} = -25V
C _{riss}	Reverse Transfer Capacitance	—	220	—		f = 1.0kHz

Avalanche Characteristics

	Parameter	Typ.	Max.	Units
E _{AS}	Single Pulse Avalanche Energy ②	—	120	mJ
I _{AR}	Avalanche Current ①	—	-9.6	A

Diode Characteristics

	Parameter	Min.	Typ.	Max.	Units	Conditions
I _S	Continuous Source Current (Body Diode)	—	—	-2.5	A	MOSFET symbol showing the integral reverse p-n junction diode. 
I _{SM}	Pulsed Source Current (Body Diode) ①	—	—	-96		
V _{SD}	Diode Forward Voltage	—	—	-1.2	V	T _J = 25°C, I _S = -2.5A, V _{GS} = 0V ③
t _{rr}	Reverse Recovery Time	—	51	76	ns	T _J = 25°C, I _F = -2.5A, V _{DD} = -24V
Q _{rr}	Reverse Recovery Charge	—	35	53	nC	di/dt = 100A/μs ③

Thermal Resistance

	Parameter	Typ.	Max.	Units
R _{θJL}	Junction-to-Drain Lead ⑤	—	20	°C/W
R _{θJA}	Junction-to-Ambient ④	—	50	

Notes:

- ① Repetitive rating; pulse width limited by max. junction temperature.
- ② Starting T_J = 25°C, L = 2.6mH, R_G = 25Ω, I_{AS} = -9.6A.
- ③ Pulse width ≤ 400μs; duty cycle ≤ 2%.
- ④ When mounted on 1 inch square copper board.
- ⑤ R_θ is measured at T_J of approximately 90°C.
- ⑥ For DESIGN AID ONLY, not subject to production testing.

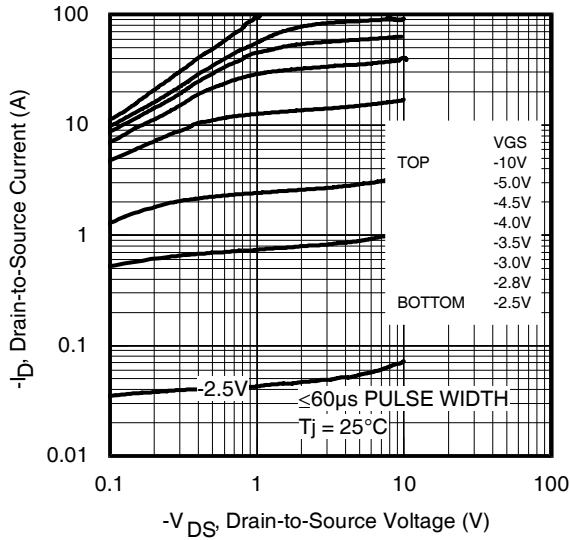

Fig 1. Typical Output Characteristics

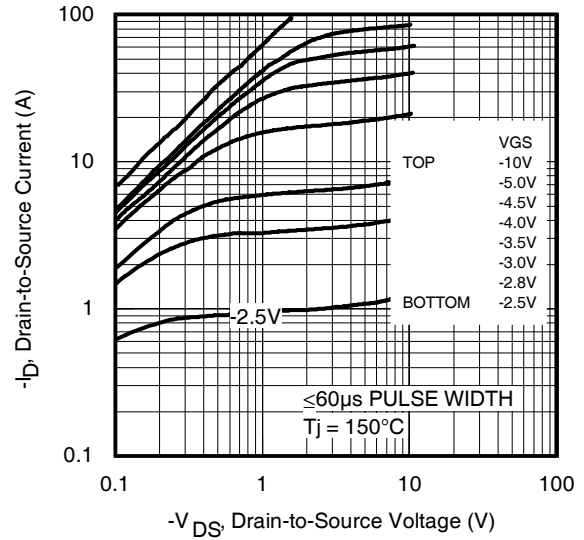

Fig 2. Typical Output Characteristics

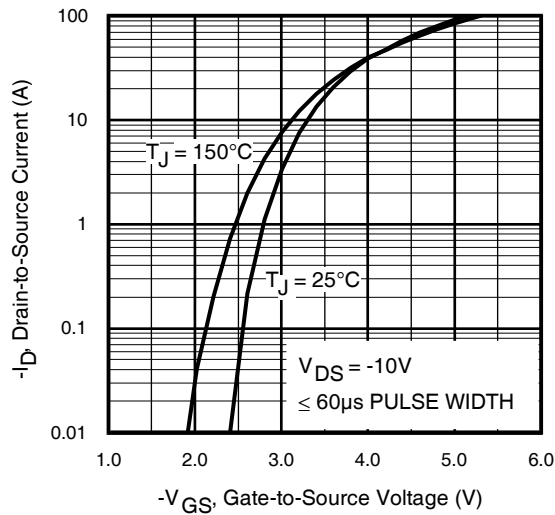

Fig 3. Typical Transfer Characteristics

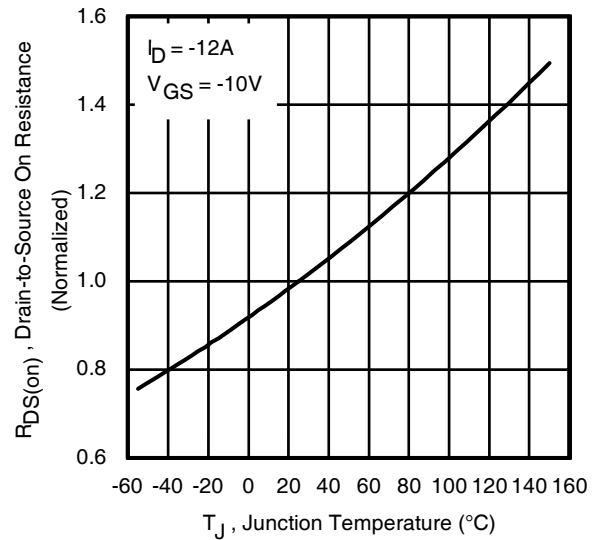

Fig 4. Normalized On-Resistance vs. Temperature

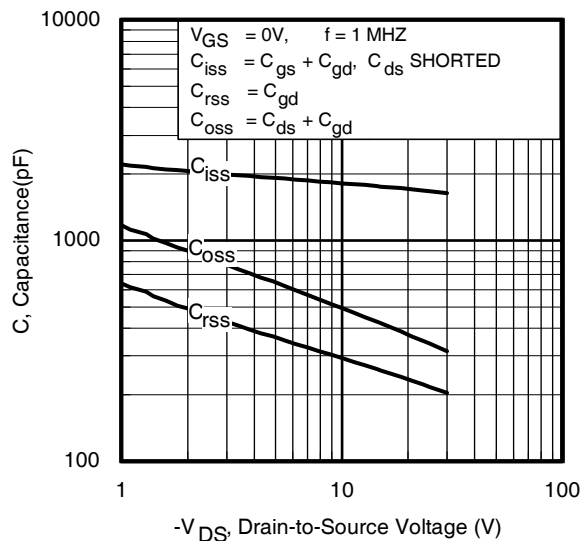

Fig 5. Typical Capacitance vs. Drain-to-Source Voltage
www.irf.com

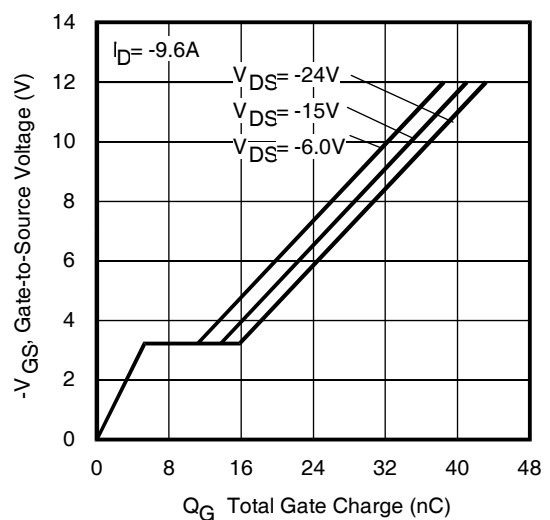

Fig 6. Typical Gate Charge vs. Gate-to-Source Voltage

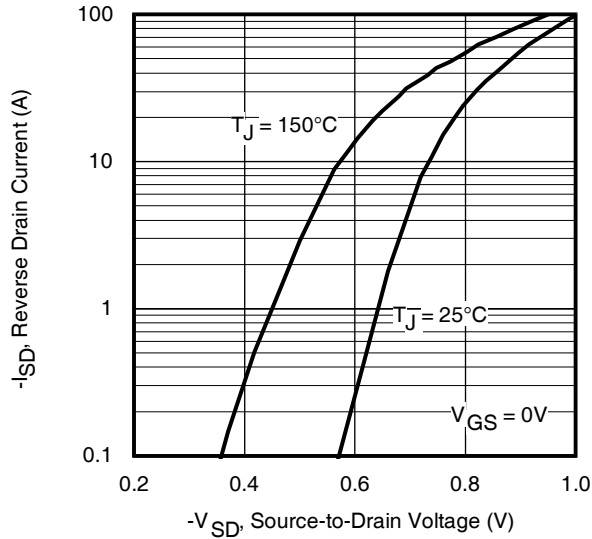

Fig 7. Typical Source-Drain Diode Forward Voltage

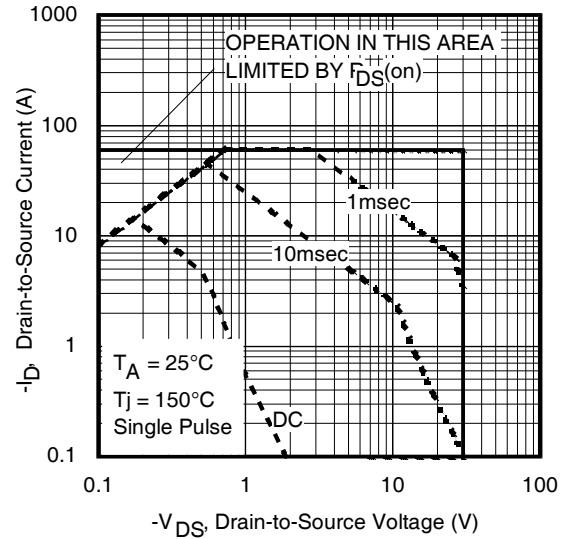

Fig 8. Maximum Safe Operating Area

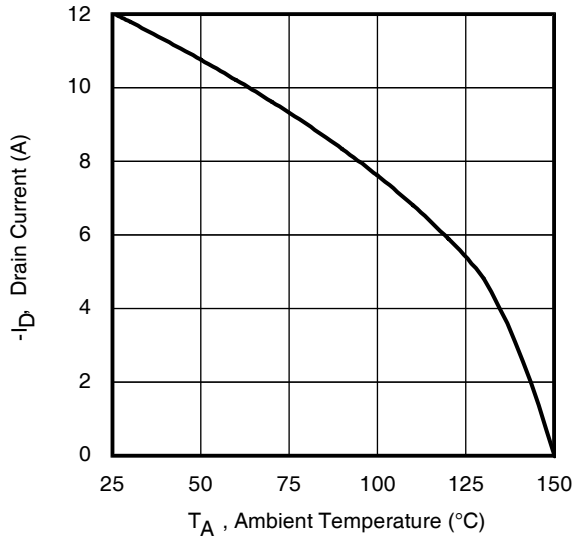

Fig 9. Maximum Drain Current vs. Ambient Temperature

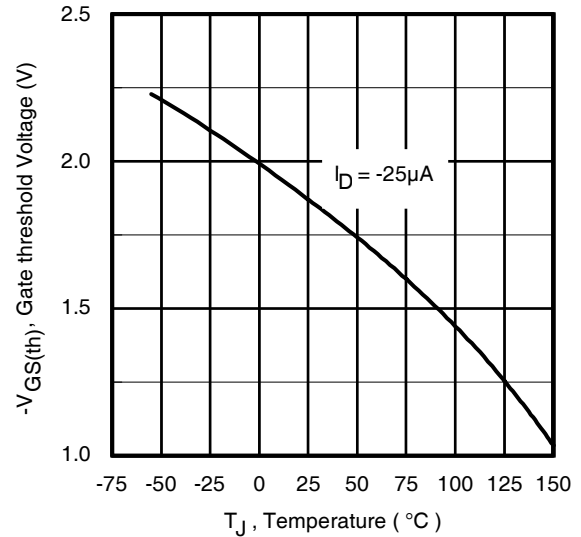

Fig 10. Threshold Voltage vs. Temperature

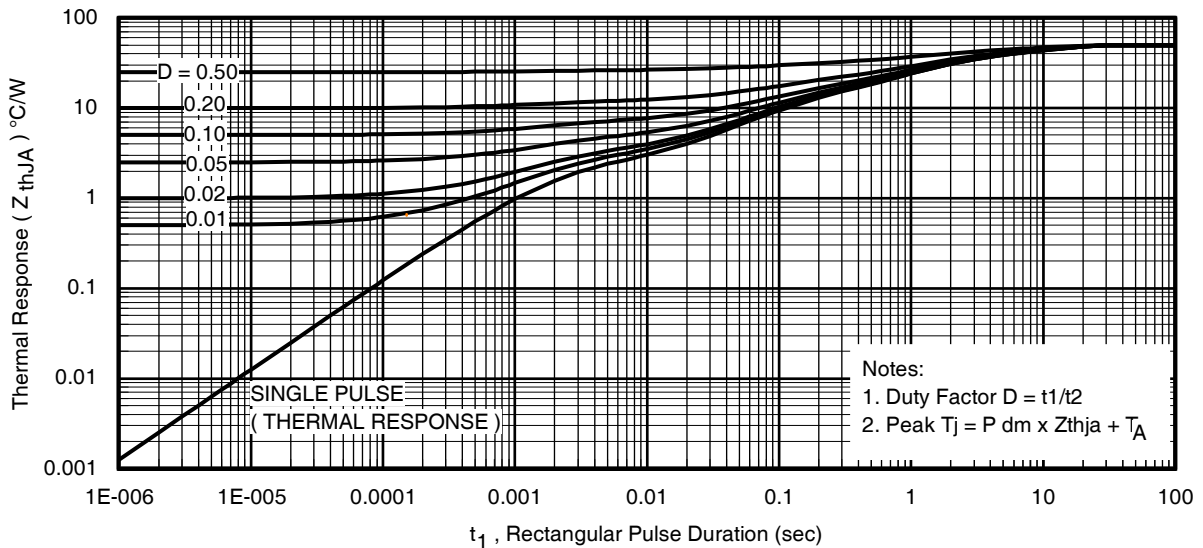

Fig 11. Maximum Effective Transient Thermal Impedance, Junction-to-Ambient

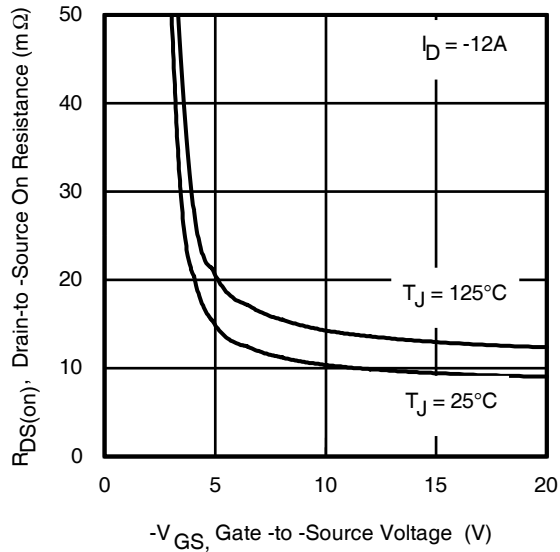

Fig 12. On-Resistance vs. Gate Voltage

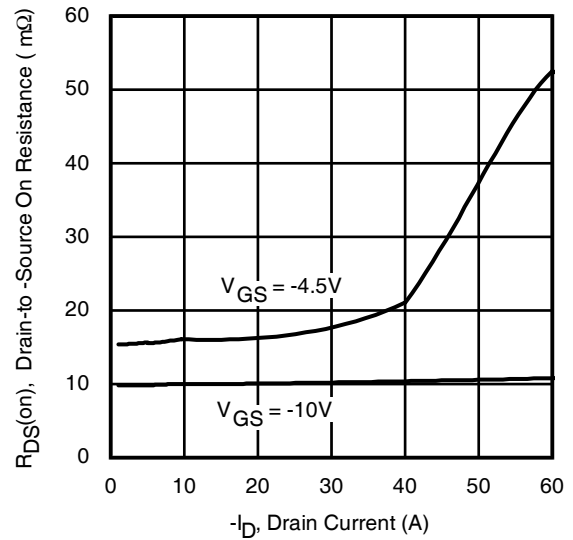

Fig 13. Typical On-Resistance vs. Drain Current

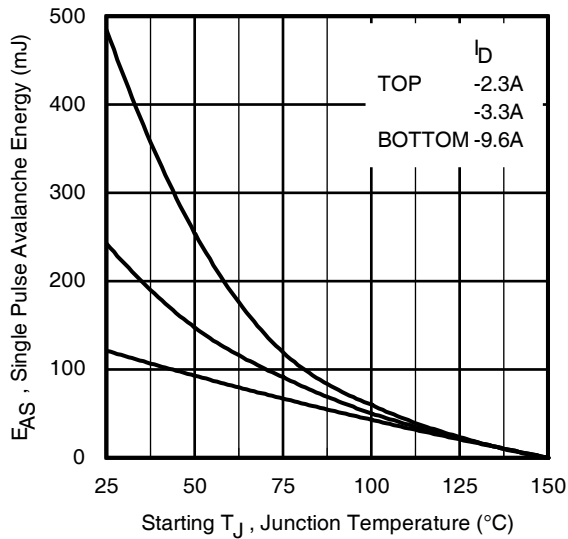

Fig 14. Maximum Avalanche Energy vs. Drain Current

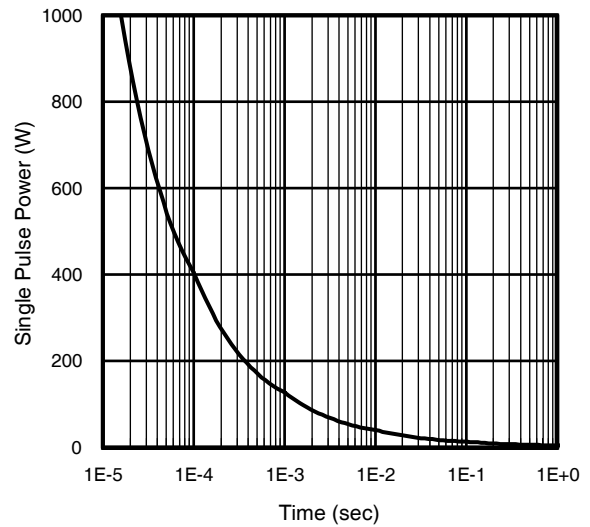
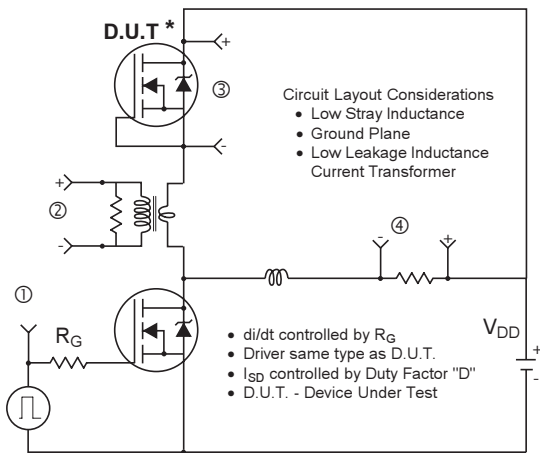
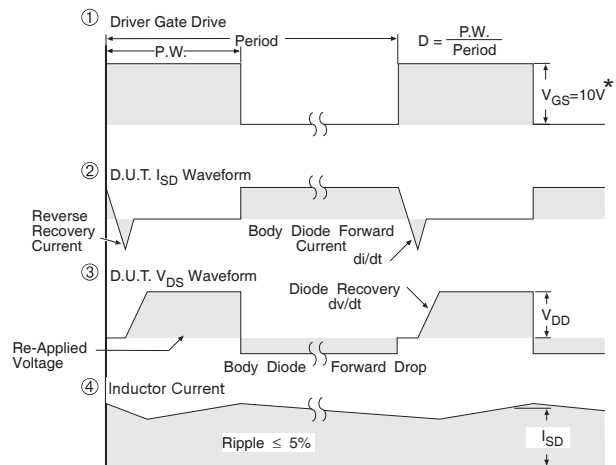

Fig 16. Typical Power vs. Time



* Reverse Polarity of D.U.T for P-Channel



* $V_{GS} = 5V$ for Logic Level Devices

Fig 17. Diode Reverse Recovery Test Circuit for P-Channel HEXFET® Power MOSFETs

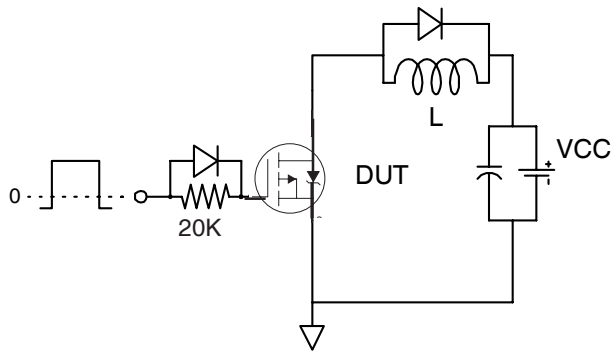

Fig 18a. Gate Charge Test Circuit

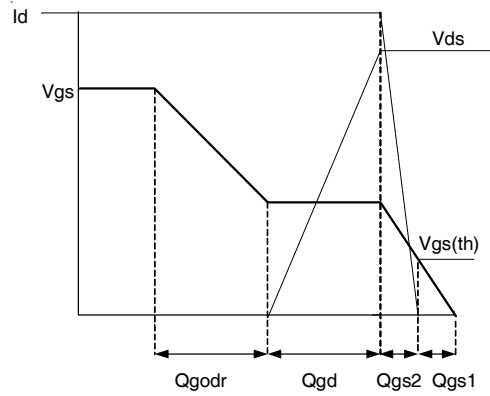

Fig 18b. Gate Charge Waveform

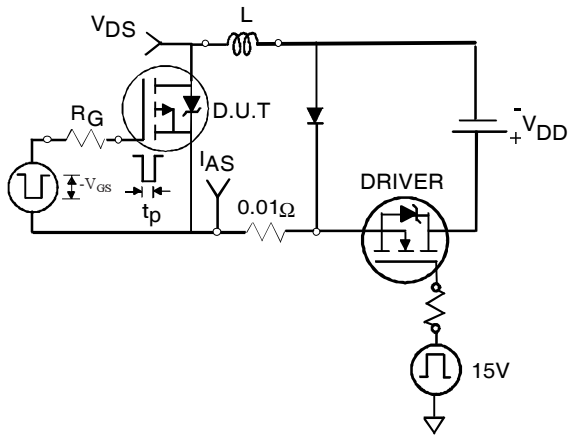

Fig 19a. Unclamped Inductive Test Circuit

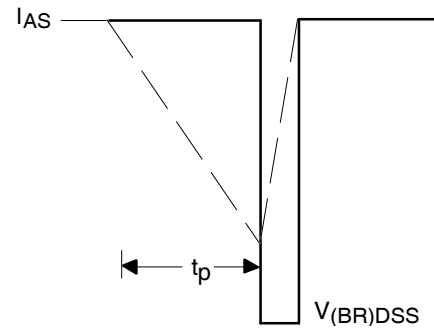

Fig 19b. Unclamped Inductive Waveforms

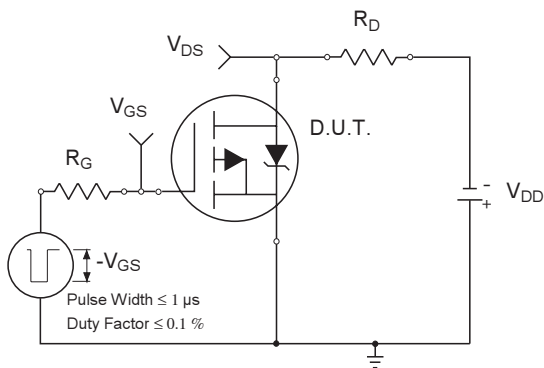

Fig 20a. Switching Time Test Circuit

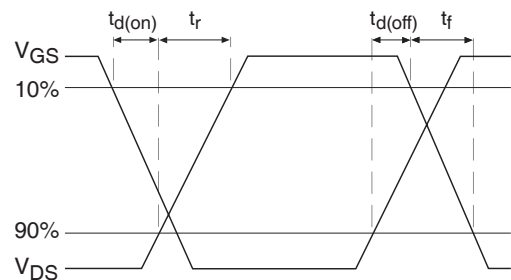
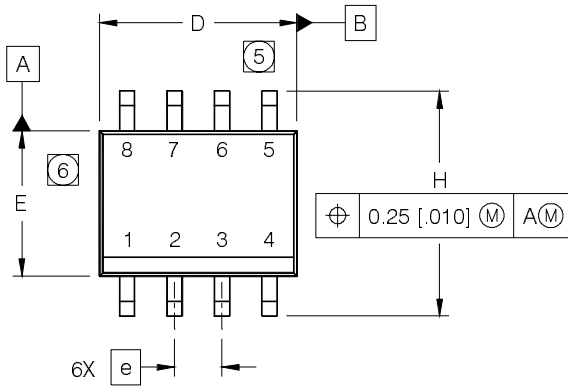

Fig 20b. Switching Time Waveforms

SO-8 Package Outline (MOSFET & Fetky)

Dimensions are shown in millimeters (inches)



DIM	INCHES		MILLIMETERS	
	MIN	MAX	MIN	MAX
A	.0532	.0688	1.35	1.75
A1	.0040	.0098	0.10	0.25
b	.013	.020	0.33	0.51
c	.0075	.0098	0.19	0.25
D	.189	.1968	4.80	5.00
E	.1497	.1574	3.80	4.00
e	.050 BASIC		1.27 BASIC	
e 1	.025 BASIC		0.635 BASIC	
H	.2284	.2440	5.80	6.20
K	.0099	.0196	0.25	0.50
L	.016	.050	0.40	1.27
y	0°	8°	0°	8°

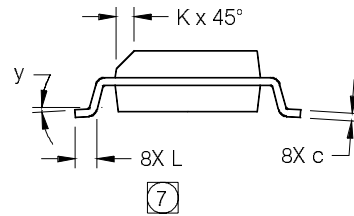
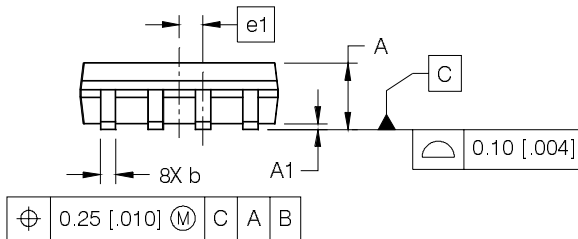

FOOTPRINT

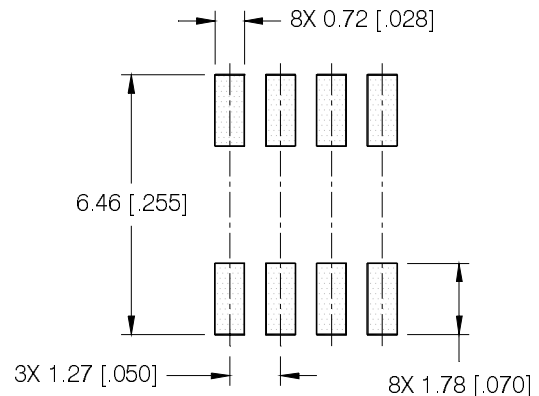

NOTES:

1. DIMENSIONING & TOLERANCING PER ASME Y14.5M-1994.
2. CONTROLLING DIMENSION: MILLIMETER
3. DIMENSIONS ARE SHOWN IN MILLIMETERS [INCHES].
4. OUTLINE CONFORMS TO JEDEC OUTLINE MS-012AA.
5. DIMENSION DOES NOT INCLUDE MOLD PROTRUSIONS. MOLD PROTRUSIONS NOT TO EXCEED 0.15 [0.006].
6. DIMENSION DOES NOT INCLUDE MOLD PROTRUSIONS. MOLD PROTRUSIONS NOT TO EXCEED 0.25 [0.010].
7. DIMENSION IS THE LENGTH OF LEAD FOR SOLDERING TO A SUBSTRATE.

SO-8 Part Marking Information

EXAMPLE: THIS IS AN IRF7101 (MOSFET)

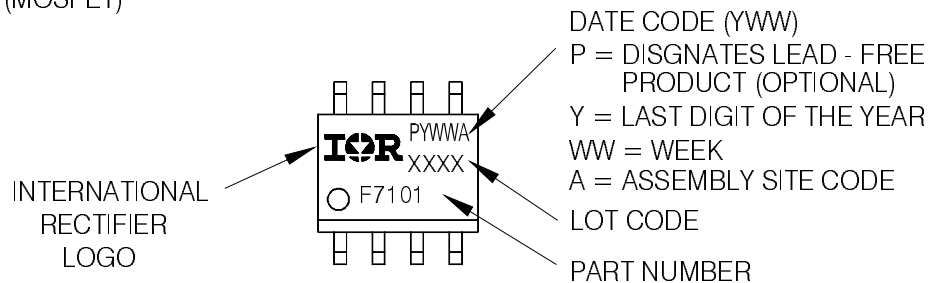

Note: For the most current drawing please refer to IR website at <http://www.irf.com/package/>

IRF9328PbF

SO-8 Tape and Reel (Dimensions are shown in millimeters (inches))

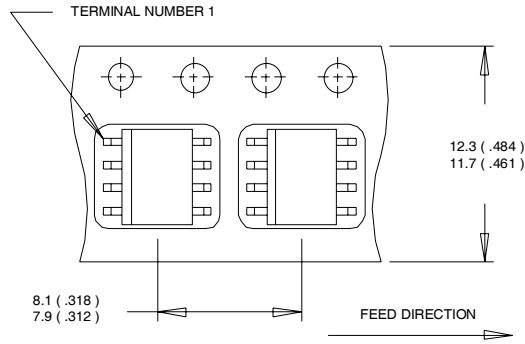

- NOTES:
1. CONTROLLING DIMENSION : MILLIMETER.
 2. ALL DIMENSIONS ARE SHOWN IN MILLIMETERS(INCHES).
 3. OUTLINE CONFORMS TO EIA-481 & EIA-541.

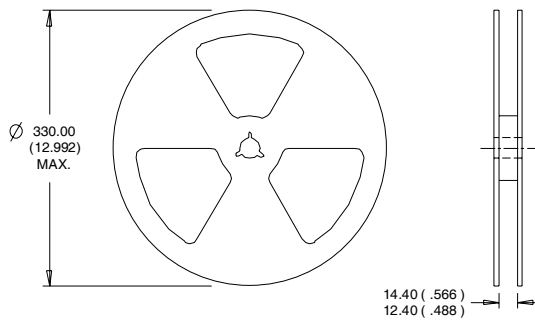

- NOTES :
1. CONTROLLING DIMENSION : MILLIMETER.
 2. OUTLINE CONFORMS TO EIA-481 & EIA-541.

Qualification Information†

Qualification level	Consumer ††	
	(per JEDEC JESD47F††† guidelines)	
Moisture Sensitivity Level	SO-8	MSL1 (per JEDEC J-STD-020D†††)
RoHS Compliant	Yes	

† Qualification standards can be found at International Rectifier's web site
<http://www.irf.com/product-info/reliability>

†† Higher qualification ratings may be available should the user have such requirements.
Please contact your International Rectifier sales representative for further information:
<http://www.irf.com/whoto-call/salesrep/>

††† Applicable version of JEDEC standard at the time of product release.

Data and specifications subject to change without notice.