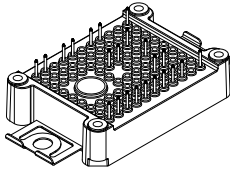

ACEPACK™ 1 converter inverter brake, 1200 V, 15 A, trench gate field-stop M series IGBT with soft diode and NTC

ACEPACK™ 1

Features

- ACEPACK™ 1 power module
 - DBC Cu Al₂O₃ Cu
- Converter inverter brake topology
 - 1600 V, very low drop rectifiers for converter
 - 1200 V, 15 A IGBTs and diodes
 - Soft and fast recovery diode
- Integrated NTC

Applications

- Inverters
- Motor drives

Description

This power module is a converter-inverter brake (CIB) topology in an ACEPACK™ 1 package with NTC, integrating the advanced trench gate field-stop technology from STMicroelectronics. This new IGBT technology represents the best compromise between conduction and switching loss, to maximize the efficiency of any converter system up to 20 kHz.

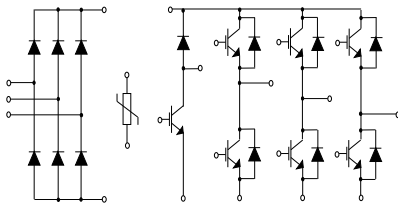

Product status

A1C15S12M3

Product summary

Order code	A1C15S12M3
Marking	A1C15S12M3
Package	ACEPACK™ 1
Leads type	Solder contact pins

1 Electrical ratings

1.1 Inverter stage

Limiting values at $T_J = 25\text{ °C}$, unless otherwise specified.

1.1.1 IGBTs

Table 1. Absolute maximum ratings of the IGBTs, inverter stage

Symbol	Description	Value	Unit
V_{CES}	Collector-emitter voltage ($V_{GE} = 0$)	1200	V
I_C	Continuous collector current at $T_C = 100\text{ °C}$	15	A
$I_{CP}^{(1)}$	Pulsed collector current ($t_p = 1\text{ ms}$)	30	A
V_{GE}	Gate-emitter voltage	± 20	V
P_{TOT}	Total power dissipation of each IGBT ($T_C = 25\text{ °C}$, $T_J = 175\text{ °C}$)	142.8	W
T_{JMAX}	Maximum junction temperature	175	$^{\circ}\text{C}$
T_{Jop}	Operating junction temperature range under switching conditions	-40 to 150	$^{\circ}\text{C}$

1. Pulse width limited by maximum junction temperature.

Table 2. Electrical characteristics of the IGBTs, inverter stage

Symbol	Parameter	Test conditions	Min.	Typ.	Max.	Unit
$V_{(BR)CES}$	Collector-emitter breakdown voltage	$I_C = 1\text{ mA}$, $V_{GE} = 0\text{ V}$	1200			V
$V_{CE(sat)}$ (terminal)	Collector-emitter saturation voltage	$V_{GE} = 15\text{ V}$, $I_C = 15\text{ A}$		1.95	2.45	V
		$V_{GE} = 15\text{ V}$, $I_C = 15\text{ A}$, $T_J = 150\text{ °C}$		2.3		V
$V_{GE(th)}$	Gate threshold voltage	$V_{CE} = V_{GE}$, $I_C = 1\text{ mA}$	5	6	7	V
I_{CES}	Collector cut-off current	$V_{GE} = 0\text{ V}$, $V_{CE} = 1200\text{ V}$			100	μA
I_{GES}	Gate-emitter leakage current	$V_{CE} = 0\text{ V}$, $V_{GE} = \pm 20\text{ V}$			± 500	nA
C_{ies}	Input capacitance	$V_{CE} = 25\text{ V}$, $f = 1\text{ MHz}$, $V_{GE} = 0\text{ V}$		985		pF
C_{oes}	Output capacitance			118		pF
C_{res}	Reverse transfer capacitance			40		pF
Q_g	Total gate charge	$V_{CC} = 960\text{ V}$, $I_C = 15\text{ A}$, $V_{GE} = \pm 15\text{ V}$		71		nC
$t_{d(on)}$	Turn-on delay time	$V_{CC} = 600\text{ V}$, $I_C = 15\text{ A}$, $R_G = 22\ \Omega$, $V_{GE} = \pm 15\text{ V}$, $di/dt = 820\text{ A}/\mu\text{s}$		120		ns
t_r	Current rise time			14.5		ns
$E_{on}^{(1)}$	Turn-on switching energy			0.59		mJ
$t_{d(off)}$	Turn-off delay time	$V_{CC} = 600\text{ V}$, $I_C = 15\text{ A}$, $R_G = 22\ \Omega$, $V_{GE} = \pm 15\text{ V}$, $dv/dt = 8200\text{ V}/\mu\text{s}$		115		ns
t_f	Current fall time			84		ns
$E_{off}^{(2)}$	Turn-off switching energy			0.83		mJ

Symbol	Parameter	Test conditions	Min.	Typ.	Max.	Unit
$t_{d(on)}$	Turn-on delay time	$V_{CC} = 600\text{ V}$, $I_C = 15\text{ A}$, $R_G = 22\ \Omega$, $V_{GE} = \pm 15\text{ V}$, $di/dt = 690\text{ A}/\mu\text{s}$, $T_J = 150\text{ }^\circ\text{C}$		122		ns
t_r	Current rise time			17		ns
$E_{on}^{(1)}$	Turn-on switching energy			1.08		mJ
$t_{d(off)}$	Turn-off delay time	$V_{CC} = 600\text{ V}$, $I_C = 15\text{ A}$, $R_G = 22\ \Omega$, $V_{GE} = \pm 15\text{ V}$, $dv/dt = 7000\text{ V}/\mu\text{s}$, $T_J = 150\text{ }^\circ\text{C}$		122		ns
t_f	Current fall time			146		ns
$E_{off}^{(2)}$	Turn-off switching energy			1.06		mJ
t_{SC}	Short-circuit withstand time	$V_{CC} \leq 600\text{ V}$, $V_{GE} \leq 15\text{ V}$, $T_{Jstart} \leq 150\text{ }^\circ\text{C}$	10			μs
R_{THj-c}	Thermal resistance junction-to-case	Each IGBT		0.95	1.05	$^\circ\text{C}/\text{W}$
R_{THc-h}	Thermal resistance case-to-heatsink	Each IGBT, $\lambda_{grease} = 1\text{ W}/(\text{m}\cdot^\circ\text{C})$		0.90		$^\circ\text{C}/\text{W}$

1. Including the reverse recovery of the diode.
2. Including the tail of the collector current.

1.1.2 Diode

 Limiting values at $T_J = 25\text{ °C}$, unless otherwise specified.

Table 3. Absolute maximum ratings of the diode, inverter stage

Symbol	Parameter	Value	Unit
V_{RRM}	Repetitive peak reverse voltage	1200	V
I_F	Continuous forward current at ($T_C = 100\text{ °C}$)	15	A
$I_{FP}^{(1)}$	Pulsed forward current ($t_p = 1\text{ ms}$)	30	A
T_{JMAX}	Maximum junction temperature	175	°C
T_{Jop}	Operating junction temperature range under switching conditions	-40 to 150	°C

1. Pulse width limited by maximum junction temperature.

Table 4. Electrical characteristics of the diode, inverter stage

Symbol	Parameter	Test conditions	Min.	Typ.	Max.	Unit
V_F (terminal)	Forward voltage	$I_F = 15\text{ A}$	-	3.0	3.8	V
		$I_F = 15\text{ A}, T_J = 150\text{ °C}$	-	2.1		
t_{rr}	Reverse recovery time	$I_F = 15\text{ A}, V_R = 600\text{ V}, V_{GE} = \pm 15\text{ V},$ $di_F/dt = 820\text{ A}/\mu\text{s}$	-	190		ns
Q_{rr}	Reverse recovery charge		-	1.45		μC
I_{rrm}	Reverse recovery current		-	23		A
E_{rec}	Reverse recovery energy		-	0.55		mJ
t_{rr}	Reverse recovery time	$I_F = 15\text{ A}, V_R = 600\text{ V}, V_{GE} = \pm 15\text{ V},$ $di_F/dt = 690\text{ A}/\mu\text{s}, T_J = 150\text{ °C}$	-	400		ns
Q_{rr}	Reverse recovery charge		-	2.75		μC
I_{rrm}	Reverse recovery current		-	25		A
E_{rec}	Reverse recovery energy		-	1.2		mJ
R_{THj-c}	Thermal resistance junction-to-case	Each diode	-	1.60	1.75	°C/W
R_{THc-h}	Thermal resistance case-to-heatsink	Each diode, $\lambda_{grease} = 1\text{ W}/(\text{m}\cdot\text{°C})$	-	1.15		°C/W

1.2 Brake stage

Limiting values at $T_J = 25\text{ °C}$, unless otherwise specified.

1.2.1 IGBT

Table 5. Absolute maximum ratings of the IGBT, brake stage

Symbol	Parameter	Value	Unit
V_{CES}	Collector-emitter voltage ($V_{GE} = 0$)	1200	V
I_C	Continuous collector current ($T_C = 100\text{ °C}$)	15	A
$I_{CP}^{(1)}$	Pulsed collector current ($t_p = 1\text{ ms}$)	30	A
V_{GE}	Gate-emitter voltage	± 20	V
P_{TOT}	Total power dissipation of each IGBT ($T_C = 25\text{ °C}$, $T_J = 175\text{ °C}$)	142.8	W
T_{JMAX}	Maximum junction temperature	175	$^{\circ}\text{C}$
T_{Jop}	Operating junction temperature range under switching conditions	-40 to 150	$^{\circ}\text{C}$

1. Pulse width limited by maximum junction temperature.

Table 6. Electrical characteristics of the IGBT, brake stage

Symbol	Parameter	Test conditions	Min.	Typ.	Max.	Unit
$V_{(BR)CES}$	Collector-emitter breakdown voltage	$I_C = 1\text{ mA}$, $V_{GE} = 0\text{ V}$	1200			V
$V_{CE(sat)}$ (terminal)	Collector-emitter saturation voltage	$V_{GE} = 15\text{ V}$, $I_C = 15\text{ A}$		1.95	2.45	V
		$V_{GE} = 15\text{ V}$, $I_C = 15\text{ A}$, $T_J = 150\text{ °C}$		2.3		
$V_{GE(th)}$	Gate threshold voltage	$V_{CE} = V_{GE}$, $I_C = 1\text{ mA}$	5	6	7	V
I_{CES}	Collector cut-off current	$V_{GE} = 0\text{ V}$, $V_{CE} = 1200\text{ V}$			100	μA
I_{GES}	Gate-emitter leakage current	$V_{CE} = 0\text{ V}$, $V_{GE} = \pm 20\text{ V}$			± 500	nA
C_{ies}	Input capacitance	$V_{CE} = 25\text{ V}$, $f = 1\text{ MHz}$, $V_{GE} = 0\text{ V}$		985		pF
C_{oes}	Output capacitance			118		pF
C_{res}	Reverse transfer capacitance			40		pF
Q_g	Total gate charge	$V_{CC} = 960\text{ V}$, $I_C = 15\text{ A}$, $V_{GE} = \pm 15\text{ V}$		71		nC
$t_{d(on)}$	Turn-on delay time	$V_{CC} = 600\text{ V}$, $I_C = 15\text{ A}$, $R_G = 22\ \Omega$, $V_{GE} = \pm 15\text{ V}$, $di/dt = 820\text{ A}/\mu\text{s}$		120		ns
t_r	Current rise time			14.5		ns
$E_{on}^{(1)}$	Turn-on switching energy			0.59		mJ
$t_{d(off)}$	Turn-off delay time	$V_{CC} = 600\text{ V}$, $I_C = 15\text{ A}$, $R_G = 22\ \Omega$, $V_{GE} = \pm 15\text{ V}$, $dv/dt = 8200\text{ V}/\mu\text{s}$		115		ns
t_f	Current fall time			84		ns
$E_{off}^{(2)}$	Turn-off switching energy			0.83		mJ
$t_{d(on)}$	Turn-on delay time	$V_{CC} = 600\text{ V}$, $I_C = 15\text{ A}$, $R_G = 22\ \Omega$, $V_{GE} = \pm 15\text{ V}$, $di/dt = 690\text{ A}/\mu\text{s}$, $T_J = 150\text{ °C}$		122		ns
t_r	Current rise time			17		ns
E_{on}	Turn-on switching energy			1.08		mJ

Symbol	Parameter	Test conditions	Min.	Typ.	Max.	Unit
$t_{d(off)}$	Turn-off delay time	$V_{CC} = 600\text{ V}$, $I_C = 15\text{ A}$, $R_G = 22\ \Omega$, $V_{GE} = \pm 15\text{ V}$, $dv/dt = 7000\text{ V}/\mu\text{s}$, $T_J = 150\text{ }^\circ\text{C}$		122		ns
t_f	Current fall time			146		ns
E_{off}	Turn-off switching energy			1.06		mJ
t_{SC}	Short-circuit withstand time	$V_{CC} \leq 600\text{ V}$, $V_{GE} \leq 15\text{ V}$, $T_{Jstart} \leq 150\text{ }^\circ\text{C}$	10			μs
R_{THj-c}	Thermal resistance junction to case	Each IGBT		0.95	1.05	$^\circ\text{C}/\text{W}$
R_{THc-h}	Thermal resistance case to heatsink	Each IGBT, $\lambda_{grease} = 1\text{ W}/(\text{m}\cdot^\circ\text{C})$		0.90		$^\circ\text{C}/\text{W}$

1. Including the reverse recovery of the diode.
2. Including the tail of the collector current.

1.2.2 Diode
Table 7. Absolute maximum ratings of the diode, brake stage

Symbol	Parameter	Value	Unit
V_{RRM}	Repetitive peak reverse voltage	1200	V
I_F	Continuous forward current at ($T_C = 100\text{ °C}$)	15	A
$I_{FP}^{(1)}$	Pulsed forward current ($t_p = 1\text{ ms}$)	30	A
T_{JMAX}	Maximum junction temperature	175	°C
T_{Jop}	Operating junction temperature range under switching conditions	-40 to 150	°C

1. Pulse width limited by maximum junction temperature.

Table 8. Electrical characteristics of the diode, brake stage

Symbol	Parameter	Test conditions	Min.	Typ.	Max.	Unit		
$V_F(\text{terminal})$	Forward voltage	$I_F = 15\text{ A}$	-	3.0	3.8	V		
		$I_F = 15\text{ A}, T_J = 150\text{ °C}$	-	2.1				
t_{rr}	Reverse recovery time	$I_F = 15\text{ A}, V_R = 600\text{ V}, V_{GE} = \pm 15\text{ V},$ $di/dt = 820\text{ A}/\mu\text{s}$	-	190		ns		
Q_{rr}	Reverse recovery charge		-	1.45		μC		
I_{rrm}	Reverse recovery current		-	23		A		
E_{rec}	Reverse recovery energy		-	0.55		mJ		
t_{rr}	Reverse recovery time	$I_F = 15\text{ A}, V_R = 600\text{ V}, V_{GE} = \pm 15\text{ V},$ $di/dt = 690\text{ A}/\mu\text{s}, T_J = 150\text{ °C}$	-	400		ns		
			Q_{rr}	Reverse recovery charge	-	2.75		μC
			I_{rrm}	Reverse recovery current	-	25		A
			E_{rec}	Reverse recovery energy	-	1.2		mJ
R_{THJ-c}	Thermal resistance junction-to- case	Each diode	-	1.60	1.75	°C/W		
R_{THc-h}	Thermal resistance case-to-heatsink	Each diode, $\lambda_{grease} = 1\text{ W}/(\text{m}\cdot\text{°C})$	-	1.15		°C/W		

1.3 Converter stage

Limiting values at $T_J = 25\text{ °C}$, unless otherwise specified.

Table 9. Absolute maximum ratings of the bridge rectifiers

Symbol	Description	Value	Unit
V_{RRM}	Repetitive peak reverse voltage	1600	V
I_F	RMS forward current	30	A
I_{FSM}	Forward surge current $t_p = 10\text{ ms}$, $T_C = 25\text{ °C}$	315	A
	Forward surge current $t_p = 10\text{ ms}$, $T_C = 150\text{ °C}$	250	
I^2t	$t_p = 10\text{ ms}$, $T_C = 25\text{ °C}$	496	A ² s
	$t_p = 10\text{ ms}$, $T_C = 150\text{ °C}$	312	
T_{JMAX}	Maximum junction temperature	175	°C
T_{Jop}	Operating junction temperature range under switching conditions	-40 to 150	°C

Table 10. Electrical characteristics of the bridge rectifiers

Symbol	Parameter	Test conditions	Min.	Typ.	Max.	Unit
V_F (terminal)	Forward voltage	$I_F = 15\text{ A}$	-	0.97	1.4	V
		$I_F = 15\text{ A}$, $T_J = 150\text{ °C}$	-	0.85		
I_R	Reverse current	$T_J = 150\text{ °C}$, $V_R = 1600\text{ V}$	-	1		mA
R_{THj-c}	Thermal resistance junction-to-case	Each diode	-	1.20	1.35	°C/W
R_{THc-h}	Thermal resistance case-to-heatsink	Each diode, $\lambda_{grease} = 1\text{ W/(m}\cdot\text{°C)}$	-	1.15		°C/W

1.4 NTC

Table 11. NTC temperature sensor, considered as stand-alone

Symbol	Parameter	Test condition	Min.	Typ.	Max.	Unit
R ₂₅	Resistance	T = 25 °C		5		kΩ
R ₁₀₀	Resistance	T = 100 °C		493		Ω
ΔR/R	Deviation of R ₁₀₀		-5		+5	%
B _{25/50}	B-constant			3375		K
B _{25/80}	B-constant			3411		K
T	Operating temperature range		-40		150	°C

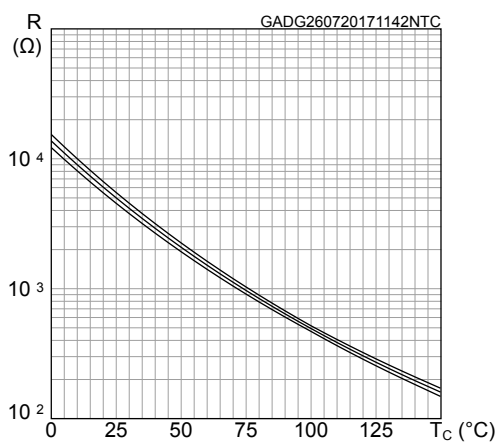
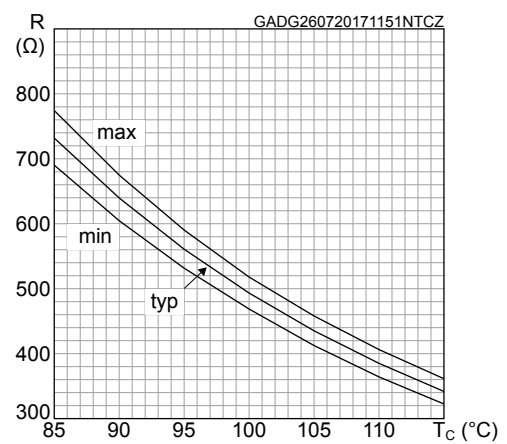
Figure 3. NTC resistance vs temperature

Figure 4. NTC resistance vs temperature, zoom

1.5 Package

Table 12. ACEPACK™ 1 package

Symbol	Parameter	Min.	Typ.	Max.	Unit
V _{isol}	Isolation voltage (AC voltage, t = 60 s)			2500	V
T _{stg}	Storage temperature	-40		125	°C
CTI	Comparative tracking index	200			
L _s	Stray inductance module P1 - EW loop		28.7		nH
R _s	Module single lead resistance , terminal to chip		3.9		mΩ

2 Electrical characteristics (curves)

Figure 5. IGBT output characteristics
($V_{GE} = 15\text{ V}$, terminal)

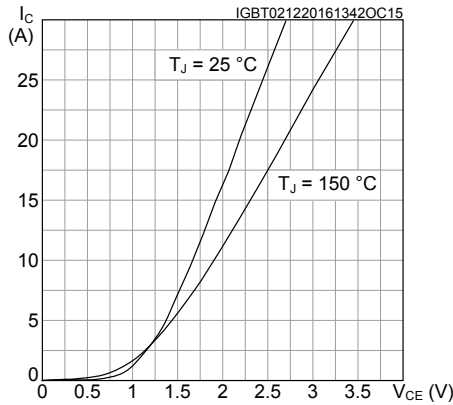

Figure 6. IGBT output characteristics
($T_J = 150\text{ }^\circ\text{C}$, terminal)

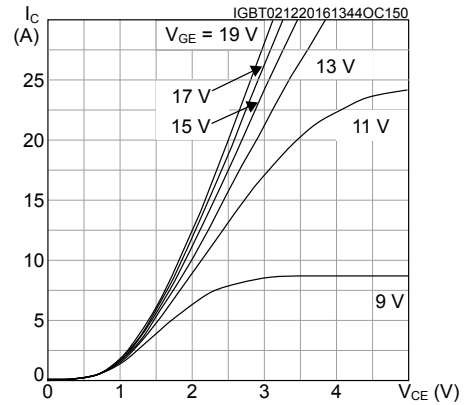

Figure 7. IGBT transfer characteristics
($V_{CE} = 15\text{ V}$, terminal)

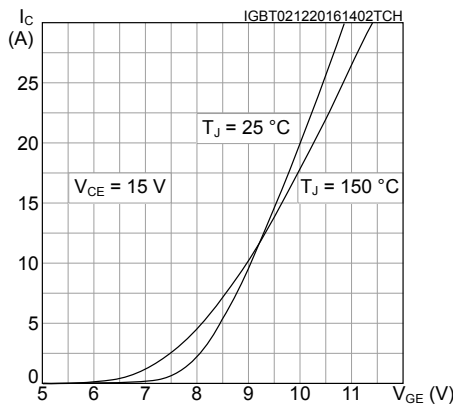

Figure 8. IGBT collector current vs case temperature

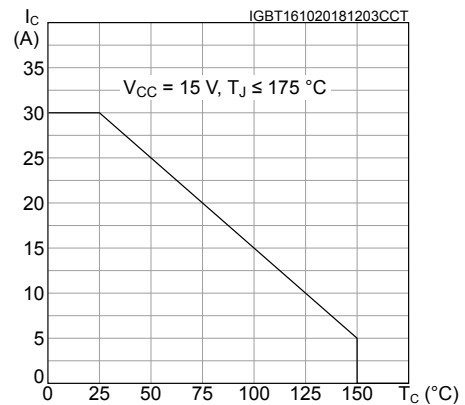

Figure 9. Switching energy vs gate resistance

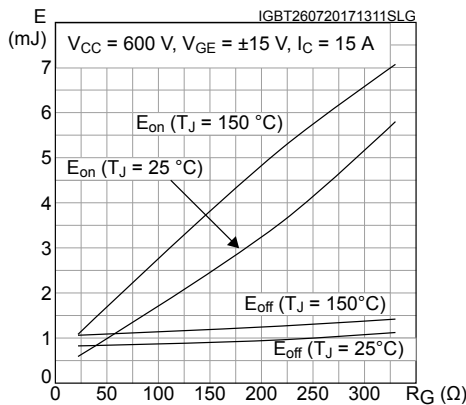

Figure 10. Switching energy vs collector current

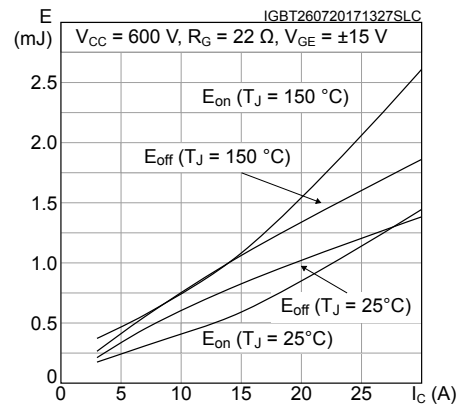

Figure 11. IGBT reverse biased safe operating area (RBSOA)

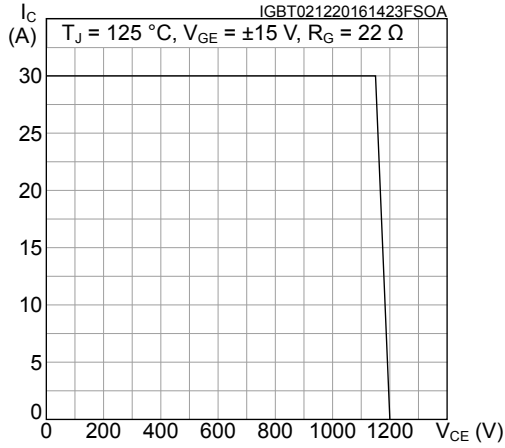

Figure 12. Diode forward characteristics (terminal)

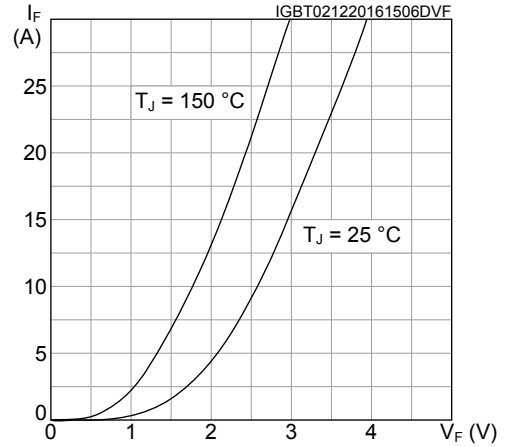

Figure 13. Diode reverse recovery energy vs diode current slope

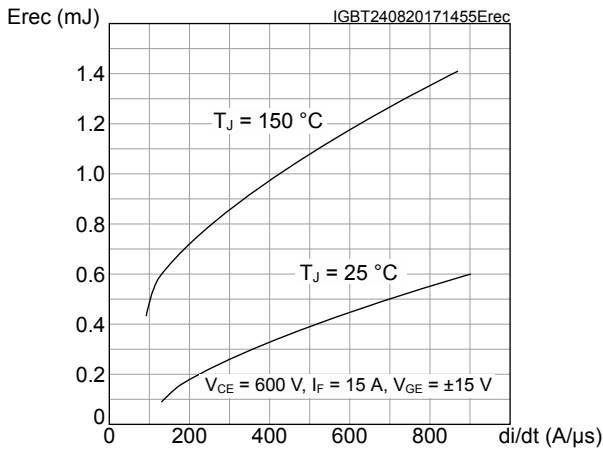

Figure 14. Diode reverse recovery energy vs forward current

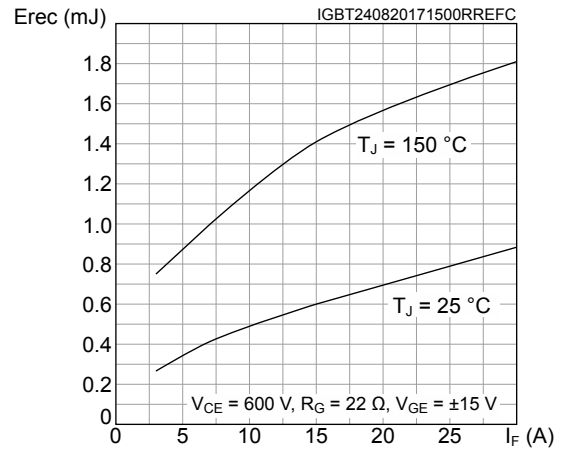

Figure 15. Diode reverse recovery energy vs gate resistance

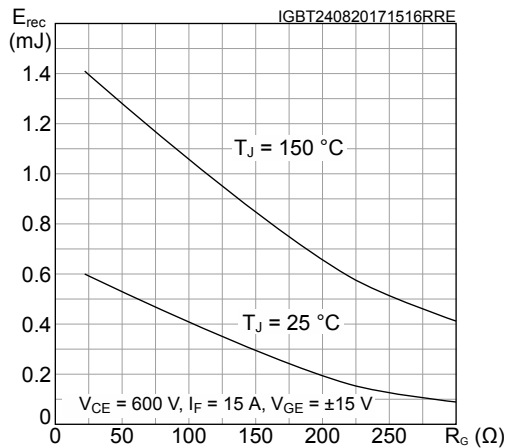

Figure 16. Converter diode forward characteristics (terminal)

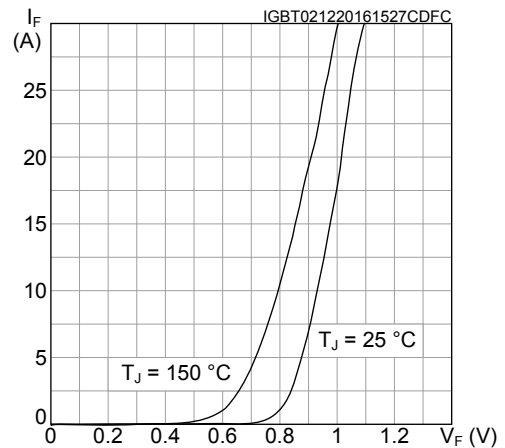

Figure 17. IGBT thermal impedance

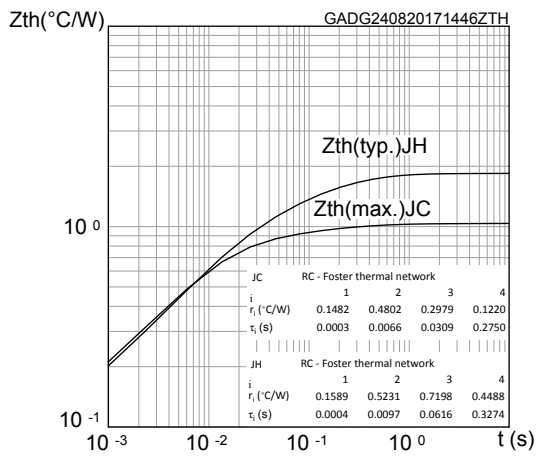
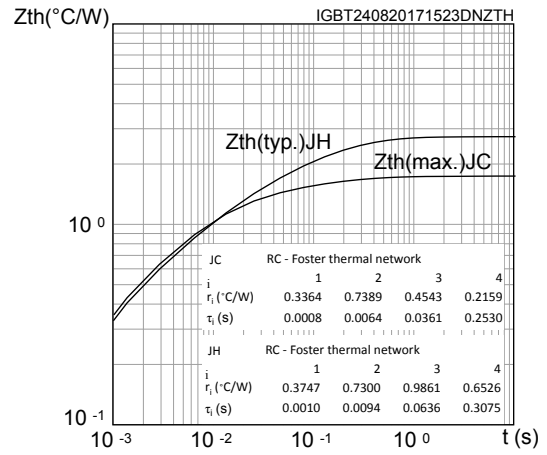
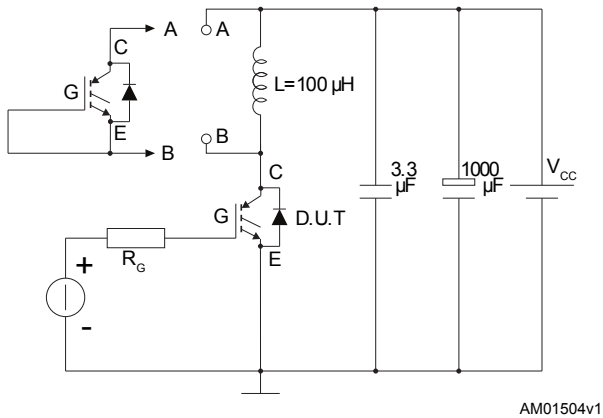
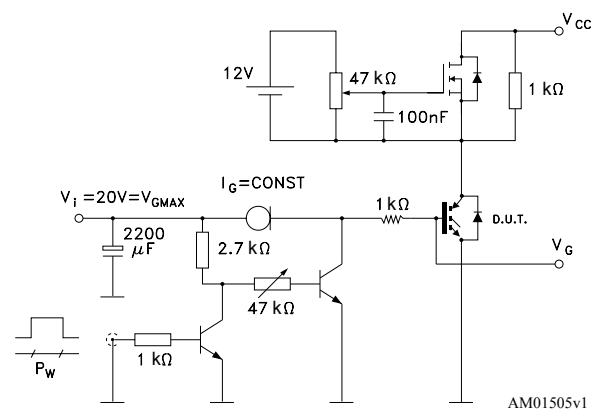
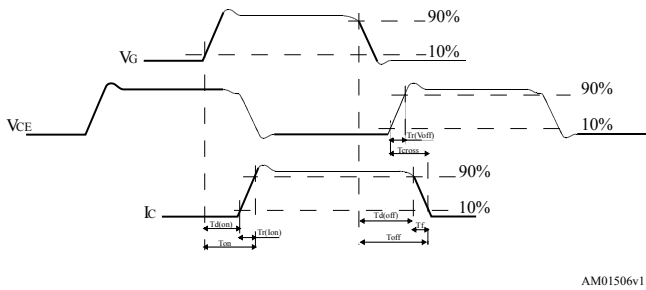
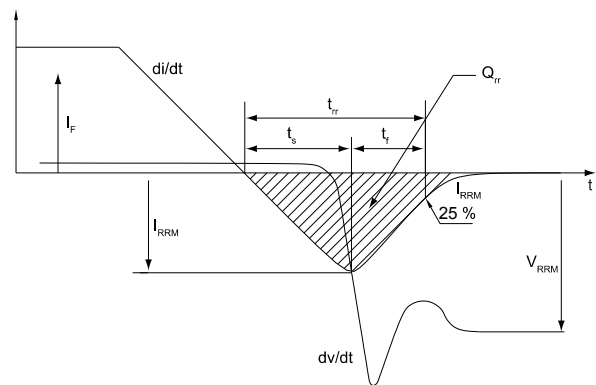

Figure 18. Inverter diode thermal impedance



3 Test circuits

Figure 19. Test circuit for inductive load switching

Figure 20. Gate charge test circuit

Figure 21. Switching waveform

Figure 22. Diode reverse recovery waveform

4 Topology and pin description

Figure 23. Electrical topology and pin description

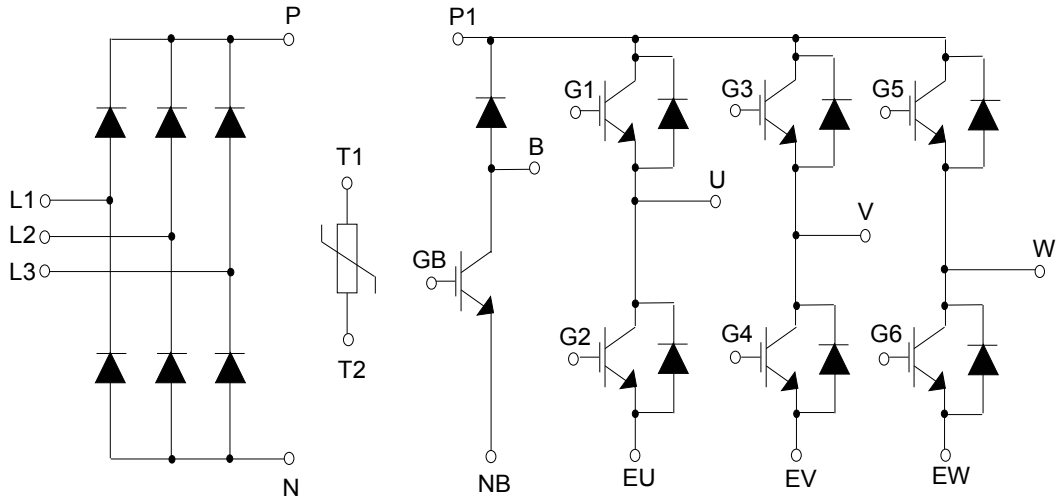
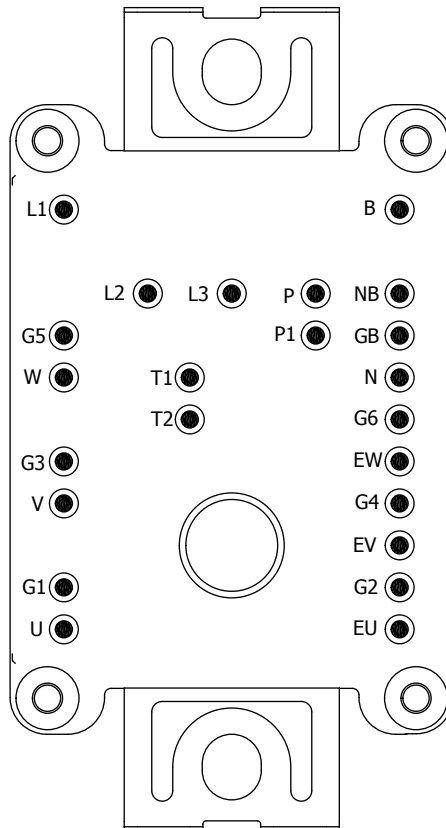

Figure 24. Package top view with CIB pinout



GIPD270320151420FSR

5 Package information

In order to meet environmental requirements, ST offers these devices in different grades of **ECOPACK®** packages, depending on their level of environmental compliance. ECOPACK® specifications, grade definitions and product status are available at: www.st.com. ECOPACK® is an ST trademark.

5.1 ACEPACK™ 1 CIB solder pins package information

Figure 25. ACEPACK™ 1 CIB solder pins package outline (dimensions are in mm)

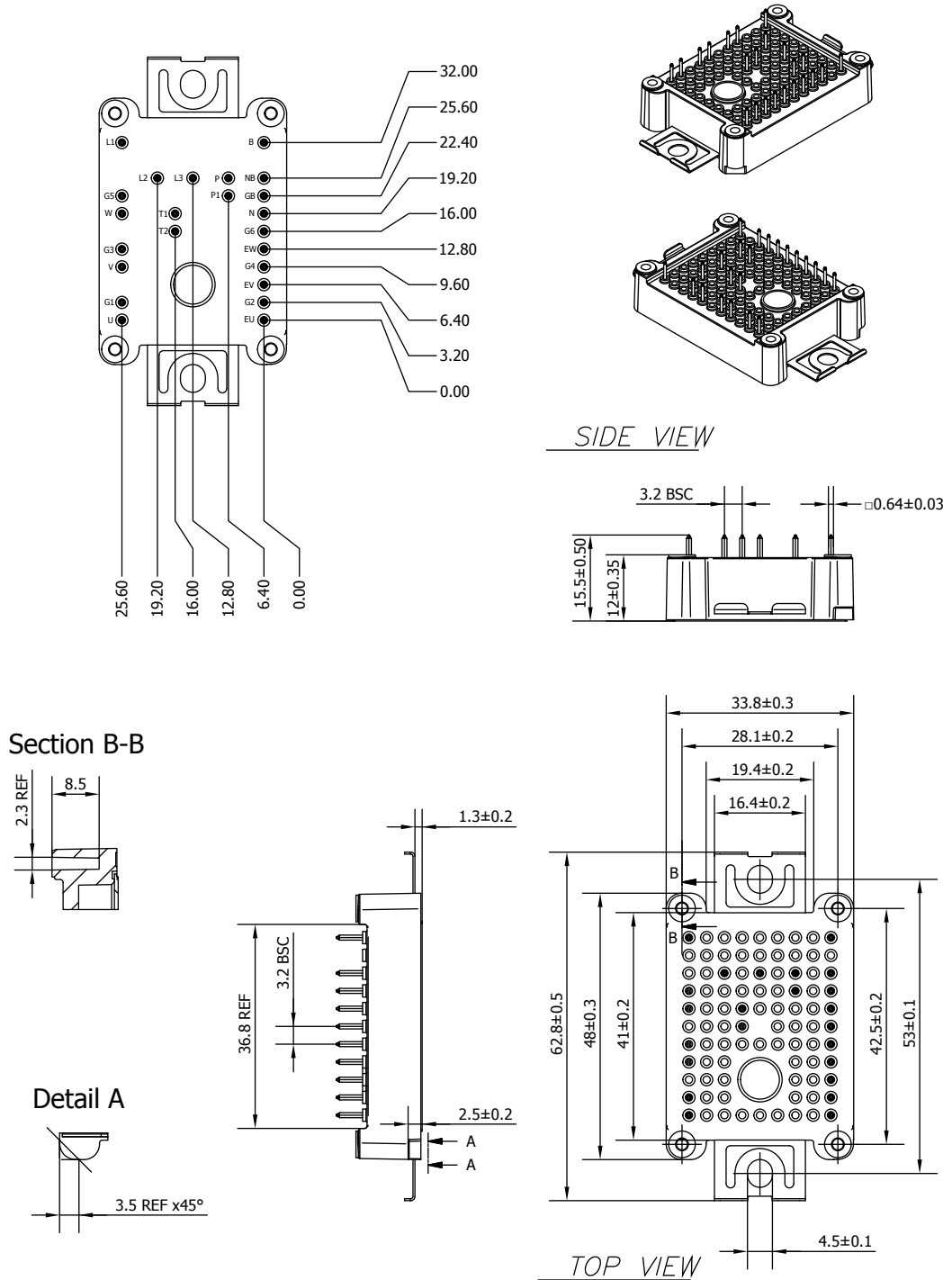

GADG110720171247SA_8569715_4

- The lead size includes the thickness of the lead plating material.
- Dimensions do not include mold protrusion.
- Package dimensions do not include any eventual metal burrs.

Revision history

Table 13. Document revision history

Date	Revision	Changes
02-May-2016	1	Initial release.
10-Mar-2017	2	Added Section 2: "Electrical characteristics curves" and Section 3: "Test circuits". Updated Section 5.1: "ACEPACK™ 1 CIB solder pins package information". Minor text changes.
26-Jul-2017	3	Datasheet promoted from preliminary data to production data. Modified Table 2: "Absolute maximum ratings of the IGBTs, inverter stage", Table 3: "Electrical characteristics of the IGBTs, inverter stage", Table 6: "Absolute maximum ratings of the IGBT, brake stage", Table 7: "Electrical characteristics of the IGBT, brake stage", Table 4: "Absolute maximum ratings of the diode, inverter stage", Table 5: "Electrical characteristics of the diode, inverter stage", Table 10: "Absolute maximum ratings of the bridge rectifiers", Table 11: "Electrical characteristics of the bridge rectifiers", Table 12: "NTC temperature sensor, considered as stand-alone", Table 13: "ACEPACK™ 1 package". Modified Figure 10: "IGBT thermal impedance" and. Modified Figure 22: "Package top view with CIB pinout". Modified Section 5: "Package information". Minor text changes.
24-Aug-2017	4	Updated Table 3: "Electrical characteristics of the IGBTs, inverter stage", Table 5: "Electrical characteristics of the diode, inverter stage", Table 7: "Electrical characteristics of the IGBT, brake stage", Table 9: "Electrical characteristics of the diode, brake stage", Table 11: "Electrical characteristics of the bridge rectifiers", Section 2: "Electrical characteristics curves". Minor text changes.
05-Oct-2017	5	Updated Table 13: "ACEPACK™ 1 package", Figure 15: "IGBT thermal impedance" and Figure 16: "Inverter diode thermal impedance". Minor text changes.
13-Feb-2018	6	Updated Figure 16. IGBT thermal impedance and Figure 17. Inverter diode thermal impedance. Removed maturity status indication from cover page. Minor text changes.
17-Oct-2018	7	Added Figure 8. IGBT collector current vs case temperature. Minor text changes

Contents

1	Electrical ratings	2
1.1	Inverter stage.....	2
1.1.1	IGBTs	2
1.1.2	Diode	4
1.2	Brake stage	5
1.2.1	IGBT	5
1.2.2	Diode	7
1.3	Converter stage.....	8
1.4	NTC.....	9
1.5	Package	9
2	Electrical characteristics curves	10
3	Test circuits	13
4	Topology and pin description	14
5	Package information	15
5.1	ACEPACK™ 1 CIB solder pins package information	15
	Revision history	17

IMPORTANT NOTICE – PLEASE READ CAREFULLY

STMicroelectronics NV and its subsidiaries (“ST”) reserve the right to make changes, corrections, enhancements, modifications, and improvements to ST products and/or to this document at any time without notice. Purchasers should obtain the latest relevant information on ST products before placing orders. ST products are sold pursuant to ST’s terms and conditions of sale in place at the time of order acknowledgement.

Purchasers are solely responsible for the choice, selection, and use of ST products and ST assumes no liability for application assistance or the design of Purchasers’ products.

No license, express or implied, to any intellectual property right is granted by ST herein.

Resale of ST products with provisions different from the information set forth herein shall void any warranty granted by ST for such product.

ST and the ST logo are trademarks of ST. All other product or service names are the property of their respective owners.

Information in this document supersedes and replaces information previously supplied in any prior versions of this document.

© 2018 STMicroelectronics – All rights reserved

Mouser Electronics

Authorized Distributor

Click to View Pricing, Inventory, Delivery & Lifecycle Information:

[STMicroelectronics:](#)

[A1C15S12M3](#)